



“Energy in Motion”

4th Colloquium of the Munich School of Engineering

03.07.2014

Contents

Welcome and introduction to MSE	4
1 Oral presentations	9
1.1 Incentives for energy-efficient behavior of professional drivers – an empirical investigation using a natural field experiment	10
1.2 e-MOBILie – from concept development to HiL test bench	12
1.3 Bringing limited energy resources to market	13
1.4 Integrating requirement analysis and multi-objective optimization for office building energy retrofit strategies	14
1.5 Unified device-level modeling framework for demand scheduling	15
1.6 Analysis of potential biomimetic applications of skin analogies on the building shell	16
1.7 Watching a solar cell die – structural degradation in polymer solar cells . . .	17
1.8 Hydrogen oxidation reaction in alkaline electrolytes on Pt/C electrocatalysts: mechanistic aspects and application in fuel cell devices . .	18
1.9 Improved knowledge of wind conditions for wind turbine and wind farm control	19
1.10 Chemical storage of excess electricity – interdisciplinary collaboration at TUM	20
1.11 Analysis of a sailing concept for wind turbine	21
1.12 Combined heat and power – utilization of geothermal heat in ORC processes	22
2 Poster presentations	23
2.1 Operational range extension of gas turbine combustion by means of water injection and fuel activation	24
2.2 Network design and yield optimisation of solar district heating systems for urban applications	25
2.3 Preparation, structure and characterization of amorphous as well as crystalline macroporous germanium thin films assembled from Zintl clusters	26
2.4 Battery production at IWB	27
2.5 Wind turbine design at Lehrstuhl für Windenergie	28
2.6 An evaluation of the CO ₂ savings potential through energetic coupling of electric vehicles and building energy systems	29
2.7 The energy saving potential of vertical greenery systems in buildings	30
2.8 Influencing the morphology of organic thin films for application in photovoltaics via a mechanical approach	31
2.9 Origin of diffusion related losses in alkaline membrane electrode assemblies (MEAs)	32
2.10 Integration of micro-CHP systems in smart homes	33
2.11 Electrochemically active surface area and H ₂ -oxidation activity determination of Pd-based electrocatalysts in alkaline media	34
2.12 Thermoelectric properties of meso-porous thin films from laser-assisted wet-chemically doped group-IV nanoparticles	35

2.13	Electrochemical characterisation of phosphorus and binary phosphides	36
2.14	Enhanced efficiency by solvent treatment for PTB7:PC71BM bulk heterojunction system	37
2.15	Synthesis of palladium-based alloy nanoparticles as electrocatalysts for hydrogen oxidation in alkaline media	38
2.16	Resource efficiency of urban districts - development of a method to improve the energy and material-efficiency of retrofit measures in urban districts	39
2.17	Storage and PV integration in CHP facilities for residential neighborhoods	40
2.18	Evaluation of flexible power plants in the context of the interconnected power system	41
2.19	Organic photovoltaic cells: tuning the nanomorphology of ternary systems with insulating polymer	42
2.20	Organic solar cells based on aqueous processed P3P6T/C60 thin films	43
2.21	Modelling residential electricity demand at high temporal and spatial resolution	44
2.22	Energy Valley Bavaria - flexible power plants dynamics in steam generation	45
2.23	Scalable economic dispatch with continuous variables	46
2.24	All-inclusive analysis as a key factor in CO ₂ -optimal mobility	47
2.25	Spin dynamics in organic solar cells measured by pulsed electrically detected magnetic resonance	48
2.26	Recovery of waste heat by means of Organic Rankine Cycle (ORC) for power generation	49
2.27	Influence of solvent additives on performance of organic photovoltaics	50
2.28	Aqueous processed titania nanoparticle based hybrid solar cells	51
2.29	Performance of P3HT:PCBM solar cells modified with iron oxide nanoparticles	52
2.30	Numerical simulation of cavitation phenomena in Diesel injection systems	53
2.31	Polymeric electrode for all-printed organic electronics: following film formation and crystallization in-situ	54
2.32	X-ray and neutron scattering study on self-organised anodic TiO ₂ nanorods for battery applications	56
2.33	In-situ characterization of lithium ion battery during cycling for performance optimization	57
2.34	Printing active layers for application in organic solar cells	58
2.35	Block copolymer based membrane for lithium ion micro batteries	59
2.36	On reducing the communication requirements for EV charging with vehicle-originating-signals	60
2.37	Will electric vehicles overload the grid? A solution using charging control based on dynamic budgets	61
2.38	Novel thermoelectric films based on polymer-nanoparticle composite	62
2.39	Modeling and control of wind turbine systems with Permanent-Magnet Synchronous Generators (PMSG) and Doubly Fed Induction Generators (DFIG)	63
2.40	Wind Energy at Garching - open source wind park planning	64
2.41	Morphology evolution of TiO ₂ nanostructures by the introduction of anatase nanoparticles	65
2.42	Optimization of distribution transformer energy management system with stationary battery and electric vehicle charger	66

2.43	Hierarchically structured titania films for efficient light harvesting in dye-sensitized solar cells	67
2.44	OEMS Study on the reactivity of anode material Li ₁₅ Si ₄ with carbonate electrolyte	68
2.45	InCharge - Innovative. Intelligent.	69
2.46	An overview of life cycle assessment and nearly zero-energy buildings in Germany	70
2.47	Flexible hybrid polymer/titania films prepared via low temperature route ...	71
2.48	Power-to-Gas - mislead vision, realistic hope for solving the storage problem or even substitute for fossil fuels?	72

Notes		73
--------------	--	-----------



Looking back to the first years of the new millennium, the development of the energy mix has been quite surprising. From 2000 until 2012 coal increased its share of the total primary energy supply to 44 % worldwide—coal is the new rising star of energy sources. Certainly, we saw a steady rise in renewable energies, but on global level the strong demand increase could only be supplied by coal and

other fossil fuels. The oil price has been especially affected, making a qualitative step from 20-30 \$/bbl. to roughly 100 \$/bbl. While people expected this would pave the way for renewable technologies, the opposite happened. Unconventional fossil fuels became economically feasible and changed gas and oil markets. Nevertheless, the high energy prices have made more efficient technologies more attractive. The car industry has been making tremendous efforts to reduce fuel demand and has introduced new electric cars. The same can be observed in many other demand sectors. However, the efficiency increases cannot balance the growing demand due to economic and population growth, at least not on a global level. Nevertheless, in individual countries, a decoupling of economic growth and energy use can be observed.

In Germany the energy debate is dominated by the “Energiewende”, which is mainly concerned with the electricity sector. Enthusiasm has been replaced by skepticism due to increasing electricity prices and resistance against wind turbines and high voltage transmission lines.

The Munich School of Engineering finds itself in the middle of this transformation process. New technologies are being developed, and in addition new forms of public participation are being tested to make major changes possible. The annual meeting brings together many of our young researchers who develop brilliant ideas to solve our local, as well as the global problems.

A handwritten signature in blue ink, appearing to read 'T. Hamacher', written in a cursive style.

Thomas Hamacher
Director Munich School of Engineering

Center for Power Generation

The Center for Power Generation (CPG) is an interdisciplinary working group consisting of institutes from TUM with research activities in the field of energy conversion for power generation. Besides efficient and innovative power plant technologies, the research spectrum includes future systems for energy storage and power plant control as well as new and optimized techniques for the reduction of air and climate pollutants in the energy field.

Member institutes come from mechanical and electrical engineering as well as from the departments of Chemistry and Physics. Thus, a broad spectrum of expert knowledge is being brought together. One of the center's main purposes is its networking ability. Sharing information about research proposals, partner acquisition and active funding schemes is considered one of its fundamental goals by its members, thus enabling interdisciplinary cooperation.

The research project "Flexible Power Plants" which is part of "Energy Valley Bavaria" is an example for CPG's interdisciplinary research. Experimental investigations of combustion and evaporation are combined with theoretical approaches of power plant simulation and power system optimization.

To date 16 partners from 4 faculties share their expertise in the framework of CPG. New members are always welcome.

Network for Renewable Energy

The Network for Renewable Energy (NRG) is a research network in the framework of TUM.energy within the Munich School of Engineering (MSE). NRG acts as a platform for TUM researchers working on renewable energy projects independent of their discipline.

The network is headed by Professor P. Müller-Buschbaum, Chair for Functional Materials, and was founded to create the opportunity to stem interdisciplinary, large-scale research projects but also to foster an active communication between different research groups.

The project TUM.solar is one of 5 key labs of the "Solar Technologies go Hybrid" program of the Bavarian State Ministry. Research is carried out within the TUM groups investigating hybrid systems of nanomaterials for more efficient use of solar energy and photo-catalysis. In regular scientific meetings exchange with the other four Bavarian universities is fostered.

The researchers forming the Network for Renewable Energy are from various departments from the TUM and associated institutes: Physics, Chemistry, Engineering, Electrical Engineering and Informatics, as well as the Centre of Life and Food Sciences Weihenstephan, the Walter-Schottky-Institut and the Bavarian Center for Applied Energy Research (ZAE Bayern).

Doctoral students within the NRG use the network to find collaborators and exchange know-how and facilities. Furthermore the network coordinates visits to laboratories and aids with finding research collaborators throughout the network.

Participation in the NRG is open for all TUM researchers interested in renewable energy conversion and storage and only requires an informal email to the organizers which can be found on www.nrg.mse.tum.de.

Science Center for Electromobility

The Science Center for Electromobility (Wissenschaftszentrum Elektromobilität – WZE) is a research cluster of multiple institutions from six different faculties at TUM working together on further progress in the field of electromobility. A wide spectrum of research is covered ranging from fundamental research on future battery technologies to applied science developing innovative vehicle concepts as well as vehicle-to-grid applications.

Based on the successful completion of the MUTE project in which an electric vehicle was developed and a prototype was built, further research regarding lightweight design, efficiency and safety of such an innovative type of vehicle could be accomplished within the Visio.M project. At the same time, TUM CREATE, the joint research program between TUM and Nanyang Technological University (NTU) in Singapore, finished its concept of an electric taxi and presented its prototype at the Tokyo Motor Show last fall. The results of TUM's activities in the field of electric vehicles are highly recognized on an international level.

Despite the fact that an increasing number of electric vehicles is being commercialized by car manufacturers, there remains a large number of research questions especially regarding their integration into the larger energy system. Hence, the Science Center for Electromobility as a member of the Munich School of Engineering can address these challenges with interdisciplinary research approaches which form a vital element of TUM's energy activities.

Center for Sustainable Building

The complex interdisciplinary challenges in the fields of sustainable building and energy efficiency require new comprehensive solutions. That's the main focus of the Center for Sustainable Building as a joint cooperation between the TUM chairs of Building Physics, Building Climatology and Building Services, Energy Efficient and Sustainable Design and Building as well as Energy Economics and Application Technology.

The Center for Sustainable Building provides the basis for an extensive scientific exchange between faculties – particularly the faculties of Architecture, of Civil, Geo and Environmental Engineering, of Electrical Engineering and Information Technology as well as the whole Munich School of Engineering. Due to the cross faculty composition of the Center, the expertise reaches from the consideration of sustainable urban development and sustainable building to detailed design of energy efficient façade elements and many more aspects related to energy efficiency and the use of renewable energies in buildings. The activities range from fundamental research to practical application and teaching.

With this interdisciplinary background, the Center is able to contribute to solutions for the worldwide problem of climate change: In Germany, an essential portion of primary energy is consumed by buildings, thus holding an enormous potential for energy savings in order to reach the demanded climate protection goals. This focus is incorporated in the Center's comprehensive understanding of sustainable building: Buildings should provide a comfortable, sustainable living environment and should be designed with the local conditions in mind, such as the climate, its physical and cultural environment as well as the use of regional renewable energy sources.

Munich School of Engineering (MSE)

The Munich School of Engineering (MSE) of the Technische Universität München is based on an innovative concept motivated by the demand for the de-compartmentalization of the conventional engineering disciplines: the combination of interdisciplinary research and cross-faculty teaching. The MSE is institutionalized as an Integrative Research Center with doctorate-granting rights.

TUM.Energy is a cross-faculty research initiative within the Munich School of Engineering which offers a platform for “Green Technologies”, in particular energy research in the segments Electromobility, Power Plant Technologies, Renewable Energies, and Energy Efficiency. These main topics are represented in networks in which researchers of different faculties are working in detail on the challenges within these fields:

- In the **Center for Power Generation** the efficiency and the environmental sustainability of existing and future power plants is increased and improved by modern and innovative technologies.
- The **Network for Renewable Energy** is doing research in both, fundamental research in the field of new technologies and materials as well as improvements of existing technologies increasing their applicability.
- The **Science Center for Electromobility** contains a wide spectrum of topics from fundamental battery research, development and design of electric vehicles as well as future mobility concepts.
- The **Center for Sustainable Building** is dedicating itself to energy efficiency during the use of buildings and its consideration during planning. Thereby not only technical but also socio-ecologic aspects are integrated in urban planning approaches.

The **Teaching Department** of the Munich School of Engineering (MSE) provides currently two degree courses with the emphasis on an interdisciplinary education in the field of engineering sciences. Talents in mathematics, natural science, and medicine get the chance to have a deep look on both, results of fundamental research in engineering and science as well as entrepreneurial viability of new technologies. This combination opens the MSE-graduates great professional opportunities in the interdisciplinary business fields of the future. Since the winter semester of 2010/11, the MSE provides the bachelor course Engineering Science and the master course Industrial Biotechnology.

In **Engineering Science** (Bachelor of Science) students get a broad methodological and scientific training with a focus on mathematics and science subjects. In the fifth and sixth semester the concept of this course allows students to individually create their personalized specialization within engineering.

The course **Industrial Biotechnology** (Master of Science) qualifies graduates of science or engineering bachelor study programs in the field of white biotechnology. Therefore, the four semester curriculum contains subjects of a wide spectrum regarding life and food science as well as Process Engineering, Chemistry, Physics, Agronomy, Robotics and Information Technology.

The orientation program **studium MINT**, launched in summer semester 2014, provides High School Graduates interested in MINT (STEM) disciplines with a solid information and knowledge fundament for their study and career choice. It allows them to get in touch with different scientific disciplines and thus find out where their individual interests and strengths lie before enrolling in a certain study program.

Programme

8.30 - 9.00 am

Registration

9.00 - 9.15 am

Opening

Hans Pongratz, TUM Senior Vice President
Thomas Hamacher, Director Munich School of Engineering

9.15 - 9.45 am

Keynote: Hydrogen Fuel Cell – Future-Oriented Technology for Long-Distance Electromobility

Tobias Brunner, BMW Group

9.45 - 11.00 am

Session Chair: Markus Lienkamp, WZE MSE

Incentives for Energy-Efficient Behavior of Professional Drivers – An Empirical Investigation Using a Natural Field Experiment

Dominik Schall, Chair of Corporate Management

e-MOBILie – From Concept Development to HiL Test Bench

Christian Kandler, Chair of Energy Economics and Application Technology

Bringing Limited Energy Resources to Market

Christoph Goebel, Chair for Application and Middleware Systems

11.00 - 11.45 am

Poster Presentation/Coffee Break

11.45 - 1.00 pm

Session Chair: Werner Lang, ZNB MSE

Integrating Requirement Analysis and Multi-Objective Optimization for Office Building Energy Retrofit Strategies

Yunming Shao, Institute for Energy Efficient Building and Design

Unified Device-Level Modeling Framework for Demand Scheduling

Andreas Veit, Chair for Application and Middleware Systems

Analysis of Potential Biomimetic Applications of Skin Analogies on the Building Shell

Leopoldo Saavedra, Institute for Energy Efficient Building and Design

1.00 - 2.30 pm

Poster Presentation, Lunchbreak

2.30 - 3.45 pm

Session Chair: Peter Müller-Buschbaum, NRG MSE

Watching a Solar Cell Die – Structural Degradation in Polymer Solar Cells

Christoph Schaffer, Chair E13 for Experimental Physics

Hydrogen Oxidation Reaction in Alkaline Electrolytes on Pt/C Electrocatalysts: Mechanistic Aspects and Application in Fuel Cell Devices

Julien Durst, Chair of Technical Electrochemistry

Improved Knowledge of Wind Conditions for Wind Turbine and Wind Farm Control

Stefano Cacciola, Wind Energy Institute

3.45 - 4.30 pm

Poster Presentation, Coffee Break

4.30 - 5.45 pm

Session Chair: Hartmut Spliethoff, CPG MSE

Chemical Storage of Excess Electricity - Interdisciplinary Collaboration at TUM

Sebastian Fendt, Institute for Energy Systems

Analysis of a Sailwing Concept for Wind Turbine

Julie Piquee, Institute of Aerodynamics and Fluid Mechanics

Combined Heat and Power – Utilization of Geothermal Heat in ORC Processes

Dominik Meinel, Institute for Energy Systems

5.45 - 6.15 pm

Keynote: Coming Full Circle: Energy Research at a Synchrotron and Beyond

Alexander Hexemer, Lawrence Berkeley National Laboratory

6:15 - 6:30 pm

Summary of the Day

6.30 - 9.00 pm

Poster and Presentation Award, Colloquium Dinner

1 Oral presentations

Incentives for energy-efficient behavior of professional drivers - An empirical investigation using a natural field experiment

Dominik Schall^{a*}, Alwine Mohnen^a

^a Chair of Corporate Management, TUM School of Management

*dominik.schall@tum.de

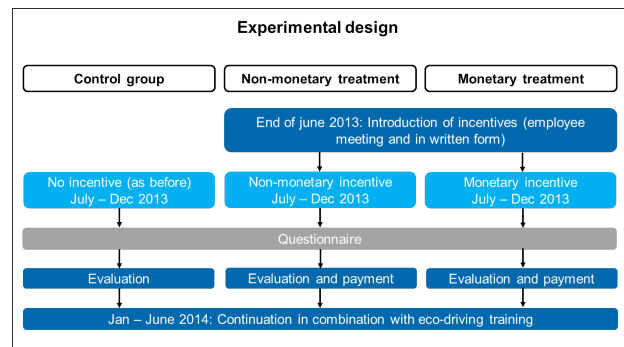
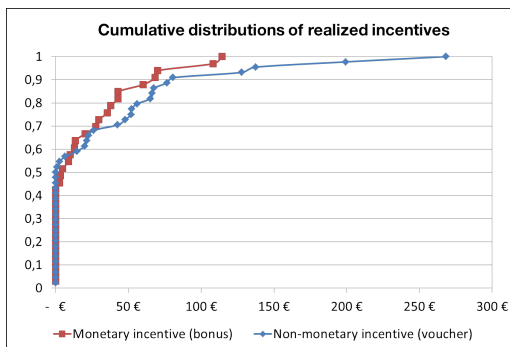

Prior empirical research in behavioral economics of energy consumption has mostly focused on household consumption and often neglected energy-efficient behavior in a professional context [1]. In addition, studies with a focus on energy efficiency in a business context often examined production related topics [2, 3], but rarely focused on transportation. Existing empirical studies on fuel saving measures in general investigate the effects of transparency, feedback, short-term effects of training and support systems [4, 5, 6]. To our knowledge, there are only very few empirical studies with a focus on mid to long term effects of fuel saving measures [7] and no studies that compare monetary and non-monetary incentives for fuel saving on a thorough scientific level or even with a natural field experiment. Our study tries to fill this gap at least partly with a natural field experiment that investigates the influence of monetary and non-monetary tangible incentives on fuel consumption of professional drivers in a German logistics company (N=87). Three treatments have been introduced and explained by the management simultaneously to the drivers of three different branches: (1) A control treatment with no incentive, (2) a monetary incentive treatment with a variable bonus depending on the individual fuel consumption compared to a historic reference value and (3) a non-monetary incentive treatment with a voucher for cinema, wellness, events, and restaurants depending on the individual fuel consumption compared to a historic reference. Applying regression analysis, we compare the effects of all treatments on fuel consumption in liters per 100 kilometers (dependent variable) and control for possible influences like, among others, vehicle type, fixed branch effects as well as demographics, risk attitude and environmental attitude of the drivers (independent variables). Our re-

sults indicate that incentives for fuel saving can have a significant effect, but without accompanying measures do not seem to be a suitable measure to tap the full fuel saving potential of professional drivers. We show that the monetary incentive did not have a statistically significant influence on the fuel consumption, whereas the non-monetary incentive lead to a statistically significant average reduction of fuel consumption of a few percent ($p < 0.01$). In addition, we give an outlook on the currently running second phase of the experiment that examines the effects of incentives in combination with eco-driving training. Preliminary results indicate that combining incentives with measures of knowledge transfer have much higher effects on fuel consumption.

[1] A. R. Carrico, et al., Motivating energy conservation in the workplace: An evaluation of the use of group-level feedback and peer education, *Journal of Environmental Psychology*, 31(1), 2011, pp. 1-13.

[2] U. Dombrowski, et al., Employee Participation for Increasing Energy Efficiency in Factory Operations, 5th International Conference on Changeable, Agile, Reconfigurable and Virtual Production, 2013, pp. 279-284.

[3] J. R. Dufflou, et al., Towards energy and resource efficient manufacturing: A processes and systems approach, *CIRP Annals Manufacturing Technology*, 61, 2012, pp. 587-609.

[4] P. J. Feenstra, et al., Literature Review of In-Vehicle Support for Fuel-Efficient Driving Related to Pricing Mechanisms, TNO Report-Nr. TNO-DV 2006 D216, 2006.

[5] M. van der Voort, et al., A prototype fuel-efficiency support tool, *Transportation Research Part C: Emerging Technologies*, 9(4), 2001, pp. 279-296.

- [6] G. Tertoolen, et al., Psychological resistance against attempts to reduce private car use, *Transportation Research Part A: Policy and Practice*, 32(3), 1998, pp. 171-181.
- [7] A. E. af Whlberg, Long-term effects of training in economical driving: Fuel consumption, accidents, driver acceleration behavior and technical feedback, *International Journal of Industrial Ergonomics*, 37(4), 2007, pp. 333-343.
-

e-MOBILie - From concept development to HiL test bench

Christian Kandler^{a*}, Patrick Wimmer^a, Manuel Lindauer^b

^a Institute for Energy Economy and Application Technology, TUM

^b Center for Sustainable Building, TUM

*christian.kandler@tum.de



The objectives of the National Development Plan for Electric Mobility, in aiming to (1) reduce transportation dependence on imported fossil fuels and (2) meet climate protection standards, open a broad field of applications for integrating electric vehicles into the world of renewable energy.

Several recent studies have confirmed that widespread use of electric vehicles can positively contribute to the integration of renewable energies, forming synergies along the path to a clean energy future. Further synergies can be realized by bringing together the parallel developments taking place in the areas of electric vehicle infrastructure and modern building energy systems. These two areas intersect in residential homes and industrial garages, where on-site energy production is becoming increasingly common. Building exteriors offer large surfaces to take advantage of solar energy, improving decentralized production, while meeting the energy needs of the buildings and associated transportation. In the simplest form, a roof-mounted PV system would provide the electricity; other possibilities include heat pumps, combined heat and power units, and small wind turbines.

As part of the e-MOBILie project sponsored by the Federal Ministry for the Environment, electromobility has to be combined with local renewable generation in an integrated approach. Integrated energy manage-

ment also includes forecasting technologies for weather and load profiles and allows for scalability from individual consumers to fleet applications. These concepts will be systematically implemented in simulations as well as tested with hardware in conditions approximating a real-world application. As an intermediate step towards practical demonstration in an inhabited showcase building, simulations will be run with hardware-in-the-loop, which can be integrated without significant modification to the existing software model.

For the demonstration, an Energy-Storage-Plus building provided by Dynahaus will be used, which, on the one hand, generates more energy than is used for heating and household applications. On the other hand, the building provides electrical and thermal storage systems, and can therefore act as a service provider for the grid.

In 2014, this building will be constructed in Hallbergmoos and equipped with a heat pump heating system, an air ventilation system, a PV system, measurement devices, an EV, and the energy management system connecting all devices. In 2015 the demonstration phase of the project starts, in which a family will live in this building and test the whole system to achieve data on the real behavior of all involved systems. This data will then be used to validate the results of the simulations and to optimize the system.

Bringing Limited Energy Resources to Market

Christoph Goebel^{a*}, Hans-Arno Jacobsen^a

^a Application and Middleware Systems, Department of Computer Science

*christoph.goebel@tum.de

The integration of non-dispatchable generation from renewable energy resources with random power output, in particular wind and solar, requires a paradigm shift from load-following supply to supply-following load. Limited energy resources (LERs) such as electric vehicles (EVs), heating, ventilation, and air conditioning (HVAC) systems, and stationary battery energy storage can be controlled to shift load on different time scales without compromising their primary use. Controlling LERs using information and communication technology (ICT) could turn out to be more flexible and less expensive than deploying dedicated centralized energy storage, but is to some extent restricted by dynamic user behavior. Their fast response capability and spatial distribution makes LERs ideal candidates for addressing various renewable integration challenges. They could help to improve voltage quality in distribution feeders and reduce the peak-to-average ratio of power demand, thereby enabling a more efficient use of existing power grid assets. They could also be used to supply balancing power, which is needed to guarantee the secure operation of power systems. To realize this potential, academia and industry have to address challenging issues, including the technical and econo-

mical evaluation of these resources, the exploration of new control and optimization techniques, and the development and evaluation of ICT systems that meet the requirements imposed by the control task. In addition to executing the control task including all required communication, optimization and input/output, such systems would have to be highly reliable and scalable. This talk/poster will present our latest research results on supplying balancing power using distributed battery energy storage and EVs. We are particularly interested in scenarios where aggregators control these resources directly to participate in existing power markets. This turns out to be a highly demanding task, both from the communication and optimization point of view. We evaluate the potential of market participation scenarios, propose pragmatic control and optimization techniques, and outline the vision of advanced ICT systems that could help to realize scalable and reliable resource control. Our evaluations are based on actual operational processes of power system operators, power market data, renewable power generation data, and simulations of dynamic resource behavior, e.g., driving patterns of vehicles.

Integrating requirement analysis and multi-objective optimization for office building energy retrofit strategies

Yunming Shao^{a*}

^a Institute of Energy Efficient and Sustainable Design and Building,
Department of Civil, Geo and Environmental Engineering

*yunming.shao@tum.de

The existing office building stock is a key target for energy retrofits to substantially reduce adverse impacts on the environment, human health, and the economy. Success of an energy retrofit project is tied with the assessment and selection of energy efficiency measures that can satisfy stakeholders' diverse, and often conflicting requirements. The current study establishes a model to support design teams in making informed decisions on energy efficiency solutions at the early design stage. The hybrid framework integrates an analysis procedure carried out by a design team and a numerical procedure of optimization carried out by computer. The analysis procedure allows the design team to identify and quantify stakeholders' concerns and needs in order to set up the optimization model properly according to the characters of the building. The automatic

optimization cycle then takes the analysis results as inputs and considers conflicting objectives simultaneously without neglecting the design constraints set by the design team. In the optimization stages, the building performance assessment model consists of different modules to calculate the numerical indicators in terms of the selected design criteria. The methodology combines these approaches and is applied to buildings as a whole. In contrast to previous approaches, this study provides a basis for embedding multi-objective optimization into the decision making on energy efficiency retrofit solutions, which considers the important role of the design team by carrying out the analysis procedure. An office building needing an energy retrofit is taken as a case study to demonstrate the feasibility of the proposed model.

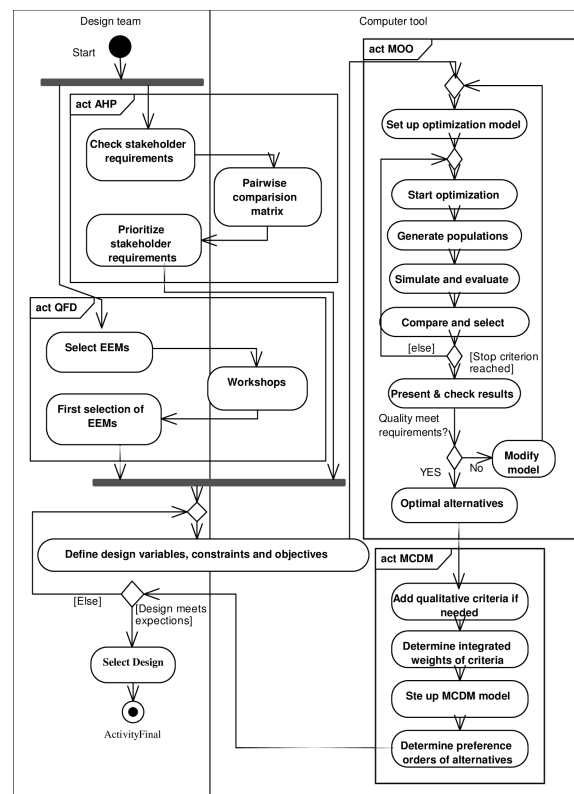
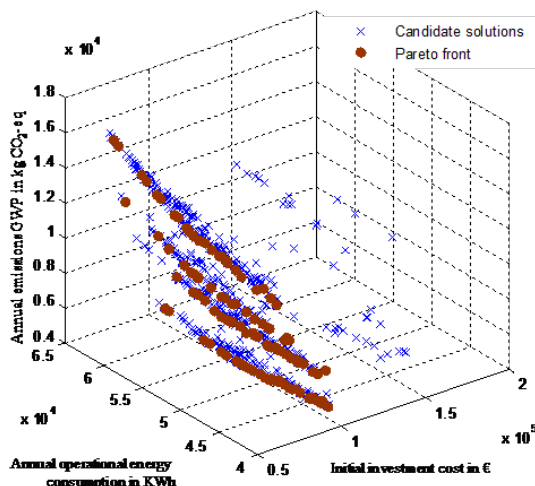

Unified Device-Level Modeling Framework for Demand Scheduling

Andreas Veit^{a*}

^a Middleware Systems Research, Department of Information Technology

*andreas.veit@tum.de

Two key issues in creating a sustainable and energy-efficient society are to increase the penetration of renewable sources, and to manage supply and demand so as to reduce demand peaks while maintaining supply and demand balance. One way, which is most commonly used, to achieve the demand supply balance is to supply all the requested demand whenever it occurs. However, attempting to achieve demand supply balance by adjusting only the supply side leads to the use of flexible (usually diesel operated) power plants that can be expensive, inefficient, and emit large amount of carbon. An alternative to adjusting the supply side only, is to also adjust the demand of the consumers via demand response programs. Several different forms of demand response programs have been developed. A typical example of an incentive based program, where customers receive payment for their participation, are Direct Load Control programs, where utilities remotely control the power consumption of consumers' appliances by switching them on/off. In small scale pilot studies, direct load control has been successful in reducing peak energy consumption, however consumers were uncomfortable with yielding control of their appliances to utility companies. Another type of demand management program is price based, where energy rates are variable and follow the real cost of electricity. The objective of this indirect method is to control the overall demand, by incentivizing consumers to flatten the demand curve by shifting energy from peak to off-peak times. A typical example of these programs is Time of Use pricing, where the price during peak times is higher than the price during off-peak times. Recent technological advances in smart meters and smart

appliances have created the potential to enable direct and real time participation of individual consumers in the energy market. However, autonomous demand side management with individual consumers requires smart agents that understand the techno-economic impacts and constraints of each device in the household. Thus, in this paper, we design a device-level modeling framework that characterizes the different device categories by their individual load constraints. Modeling the constraints of devices is fundamental for modeling the behavior of a device, its interdependencies with other devices and interactions with the agent. This framework enables the development of agents to accomplish their scheduling task based on the individual load constraints, minimizing the electricity consumption cost. We provide formal models for the device specific constraints. The devices can be divided into two groups: First, conventional loads consuming a specific predetermined amount of energy over the planning horizon to fulfill a certain task. This group can further be divided into fixed loads like entertainment devices, shiftable loads like electric vehicles and non-interruptable loads like dishwashers or washer/dryers. Second, storage loads that can store energy and have to ensure that the energy state stays between specific energy levels. This group can further be divided into electric storage devices like batteries and thermal devices like refrigerators or HVAC systems. Furthermore, we perform simulations of different device populations to characterize the scheduling complexity of the different device categories and to understand the effects of different device combinations on the time required for scheduling.

Analysis of Potential Biomimetic Applications of Skin Analogies on the Building Shell

Leopoldo Saavedra^{a*}, Werner Lang^a

^a Lehrstuhl für energieeffizientes und nachhaltiges Planen und Bauen, Fakultät für Architektur, Ingenieur fakultät Bau Geo Umwelt

*leopoldo.saavedra@tum.de



Nature has developed and introduced specific systems to accomplish the most various tasks. These (extremely) efficient biological mechanisms offer optimization and innovation models with potential applications on technology. This work structures around four main parts: While biomimetics describes the transfer of information in between biology and technology, sustainability covers the elaborated and rational use and design of materials and energy. The building specific parameters describe in a general way, the functions of the building shell. This analysis considers the building as an organismic unit, looking at it as a complex system, by integrating ecological aspects and building shell specific parameters with parameters and hierarchies of organisms. The application of organismic properties on buildings allows the interlinking between its inside and outside. These interactions carry a signifi-

cant potential for possible energetic as well as architectonic optimization. This work emphasizes on the analysis of different natural skin analogies apt to be applied to the building shell, this being held responsible for an important amount of the building's energy issues. The study focuses on the functional properties of the building shell, analyzing natural phenomena relevant for a selected group out of 29 defined functions of the building shell. The functions are grouped into inter-related functional groups corresponding to areas such as sun light, air permeability, heat energy and humidity, allowing interaction within and between the groups. Out of the conceptual contrasting of these aspects with the properties of the natural phenomena a conceptual diagrammatic presentation of the organismic building models takes place.

Watching a solar cell die - structural degradation in polymer solar cells

Christoph J. Schaffer^{a*}, Claudia M. Palumbiny^a, Martin A. Niedermeier^a, Christian Jendrecejewski^a, Gonzalo Santoro^b, Stephan Roth^b, Peter Müller-Buschbaum^a

^a Lehrstuhl für Funktionelle Materialien, Physik Department

^b P03/MiNaXS, PETRA III, DESY, Hamburg

*christoph.schaffer@ph.tum.de

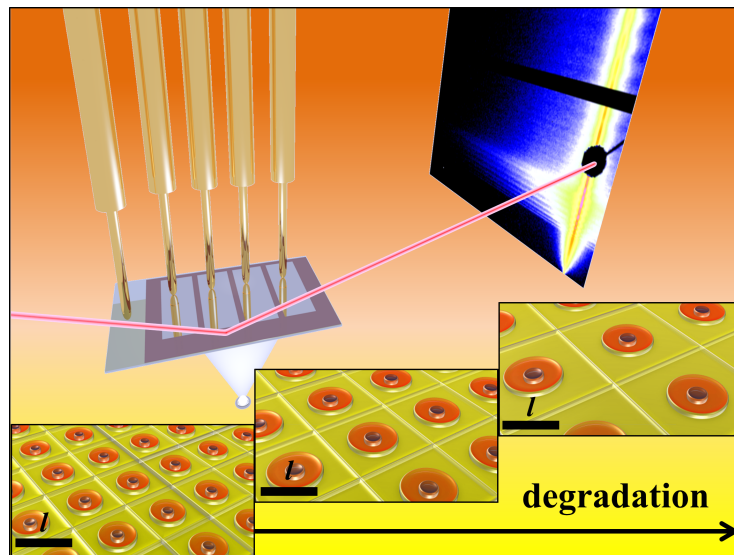

Many potential applications and the proximity of their breakthrough as every-day usage devices render organic photovoltaics (OPV) to a field of high interest both from commercial and scientific points of view. Providing the framework for low-cost, light-weight, and flexible solar cell devices with a wide variety of appearance varying from black to transparent, this class of solar cells is expected to enter a wide field of utilization ranging from personal entertainment applications to architecture where such cells could be easily integrated in buildings. Hereby, polymer-based solar cells (PSC) can be processed from solution and are therefore particularly promising for low-cost processing e.g. by roll-to-roll printing. A major challenge is, however, to optimize the stability of these solar cells since, typically, lifetimes are on an order of thousands of operating hours and, therefore, shorter than for silicon-based devices. One of the pathways to degradation which has been frequently assumed in literature but which is not yet sufficiently understood arises from a potentially non-stable morphology of the current-generating active layer. Polymer-based solar cells can only work if this active layer, in which the conversion from light into electric current takes actually place, displays a suitable morphology. In this case, domains of both an electron-acceptor and -donor material form an interpenetrating

network on a nanometer scale. Changes in this nano-structure as a consequence of solar cell operation are strongly expected to affect the solar cell's electric characteristics drastically. Whereas, so far, such transitions could not be experimentally approached, their evidence renders the focus of the presented work. In order to probe both the active layer morphology on a nanometer scale and the current-voltage (I-V) characteristics of a running P3HT:PCBM based PSC, a time-resolved in-situ (micro focused grazing incidence small angle) X-ray scattering (GISAXS) experiment with simultaneous I-V tracking of a running polymeric solar cell has been performed. This study provides a first time-resolved and simultaneous probe of both the morphological and electric characteristics of the solar cell during an early stage of operation. It reveals that the active layer morphology must not be assumed stable as domains on a scale of several ten nanometers grow with time while the mean distance between such domains is found to increase during the first few hours of operation. At the same time, the generated current output shows a significant loss. A purely geometric model is presented which directly correlates the full loss of current output with the morphological transitions found in the scattering experiments.

Hydrogen Oxidation Reaction in Alkaline Electrolytes on Pt/C Electrocatalysts: Mechanistic Aspects and Application in Fuel Cell Devices

Julien Durst^{a*}, Christoph Simon^a, Ibrahima Diallo^a, Armin Siebel^a, Phillip Rheinländer^a, Frädäric Hasché^a, Juan Herranz^a, Hubert Gasteiger^a

^a Lehrstuhl für Technische Elektrochemie, Fakultät für Chemie
*julien.durst@tum.de

Fuel cells and electrolyzers are important for renewable energy conversion and storage. They are currently based on proton-exchange membranes (PEMs) operating at low pH (pH=0), which offer high power densities, but require large amounts of noble metal for the oxygen reduction reaction (ORR) in fuel cells [1] and the oxygen evolution reaction (OER) in electrolyzers. For the hydrogen oxidation/evolution reaction (HOR/HER) only very small amounts of Pt is required due to its extremely high activity for the HOR/HER (suggested exchange current densities (i_0) on the order of 102 mA cm²Pt, measured using a specific setup in PEMFC [2]). In alkaline electrolyte, non-noble metal catalysts are very active for the ORR and for the OER. Therefore, a replacement of the noble-metal intensive PEM technology by alkaline membrane technology seems promising. Unfortunately, for yet unclear reasons, the HOR/HER kinetics on Pt are much slower in alkaline than in acid electrolytes, and large amounts of Pt are needed to catalyze the HOR/HER in alkaline environment. [3] Therefore, it is critical to develop alternative HOR/HER catalysts for alkaline electrolytes and to elucidate the reasons for the poor HOR/HER activity of Pt in alkaline electrolytes. From a mechanistic point of view, to further elucidate the HOR/HER activity differences in acid vs. base we will rigorously compare the i_0 -values in extreme pH conditions (pH=0 and pH=13) of carbon supported platinum nanoparticles (Pt/C) with that of palladium (Pd/C) and the more oxophilic iridium (Ir/C). Such rigorous comparison

has never been performed so far. Our findings point toward: a similar 100 fold activity decrease on all these surfaces when going from low to high pH; a reaction rate controlled by the Volmer step in base on Pt/C; and the H-binding energy being the unique and sole descriptor for the HOR/HER in alkaline electrolytes. Based on a detailed discussion of our data we propose a new mechanism for the HOR/HER on Pt-metals in alkaline electrolytes. [4] Exchange current densities were also evaluated in an Anion Exchange Membrane Fuel Cell (AEMFC) on Pt/C electrodes. The extracted values confirmed the trends measured by RDE in 0.1 M NaOH, with however some small discrepancies, and confirmed that a further improvement of the HOR kinetics on tuned surfaces is required to make this technology viable.

[1] H.A. Gasteiger, N.M. Markovic, Just a Dream-or Future Reality?, *Science*, 324 (2009) 48-49.

[2] K.C. Neyerlin, W. Gu, J. Jorne, H.A. Gasteiger, Study of the Exchange Current Density for the Hydrogen Oxidation and Evolution Reactions, *J. Electrochem. Soc.*, 154 (2007) B631-B635.

[3] W. Sheng, H.A. Gasteiger, Y. Shao-Horn, Hydrogen Oxidation and Evolution Reaction Kinetics on Platinum: Acid vs Alkaline Electrolytes, *J. Electrochem. Soc.*, 157 (2010) B1529-B1536.

[4] J. Durst, A. Siebel, C. Simon, F. Hasche, J. Herranz, H.A. Gasteiger, New Insights into the Electrochemical Hydrogen Oxidation and Evolution Reaction Mechanism, *Energy Environ. Sci.*, (2014).

Improved Knowledge of Wind Conditions for Wind Turbine and Wind Farm Control

Stefano Cacciola^{a*}, Carlo L. Bottasso^a

^a Lehrstuhl für Windenergie, Fakultät für Maschinenwesen

*stefano.cacciola@tum.de

Detailed knowledge of wind and flow conditions can be very valuable, as it can be used for controlling individual machines or whole wind farms according to suitable strategies, in order to achieve the best possible power capture, to reduce loads, to improve power quality, and meet other desired goals. However, at the moment wind turbines are typically equipped with anemometers and wind vanes, which often provide hub-height information with a high level of noise and disturbances. Similarly, wind farms operate based on data gathered by a small number of met-masts, which do not cover the whole wind farm area. Improved knowledge on the wind conditions on each machine and within a wind farm can be obtained directly from wind turbines, which can be used as sophisticated wind sensors. In fact, it is clear that changes in wind conditions imply changes in the wind turbine response in terms of performance and loads; therefore, by properly interpreting the wind turbine response, it is possible to measure changes in wind conditions at the wind turbine location. TUM has developed wind sensing technology that

can provide information in real-time at each wind turbine throughout a wind farm on wind speed, wind direction, vertical and horizontal shears, wake state (i.e. full, partial or no wake interference) and turbulence intensity. Some of these new approaches have been tested using high fidelity simulation models, scaled wind tunnel models and field test data [1, 2, 3], with additional development, testing and publication activities planned for the current year.

[1] C.L. Bottasso, F. Campagnolo, V. Petrovic, Wind Tunnel Testing of Scaled Wind Turbine Models beyond Aerodynamics, *Journal of Wind Engineering and Industrial Aerodynamics*, 127:11-28, doi:10.1016/j.jweia.2014.01.009, 2014.

[2] C.L. Bottasso, C.E.D. Riboldi, Estimation of Wind Misalignment and Vertical Shear from Blade Loads, *Renewable Energy*, 62:293-302, doi:10.1016/j.renene.2013.07.021, 2014.

[3] C.L. Bottasso, C.E.D. Riboldi, Validation of a Wind Misalignment Observer using Field Test Data, *Renewable Energy*, accepted, to appear, 2014.

Chemical storage of excess electricity - Interdisciplinary collaboration at TUM

Sebastian Fendt^{a*}, Harmuth Spliethoff^a, Tobias Hartmann^b, Thomas Hamacher^b, Franz Koschany^c, Kai-Olaf Hinrichsen^c, Maximilian Bernt^c, Hubert Gasteiger^c, Fabian Hähler^d, Harald Klein^d

^a Institute for Energy Systems, Department of Mechanical Engineering

^b ENS, Fakultät für Elektrotechnik und Informationstechnik

^c TC1, Department of Chemistry

^d Chair of Plant and Process Technology, Department of Mechanical Engineering

*sebastian.fendt@tum.de

The increasing feed-in of electricity from fluctuating renewable energy sources such as wind and solar puts storage solutions in Germany on top of the to-do list for research and industry. Being one of the most promising and realistic options for long-term and seasonal storage, chemical storage technologies are of special interest and supposed to become an inherent part of future energy systems. The power to gas concept addresses the specific needs of the future German and European energy systems. Excess electricity from renewables is used in this concept for hydrogen production via electrolysis. The hydrogen is then converted with carbon dioxide for example from biogas plants to synthetic natural gas (SNG) which can be injected, distributed and stored in the natural gas infrastructure. This concept requires an interdisciplinary approach due to the diversity of skills required along the process chain from excess electrical power to storable SNG. Electrical engineers, chemical engineers and mechanical engineers as well as physicists, mathematicians and economists have to work together and share their know-how to tackle this elaborate interdisciplinary puzzle and bring the technology to market. This approach is taken by an interdisciplinary group of researchers at TUM. The goal of the project is to bring these professions together, network and start collaboration to show existing overlaps, carve out synergy effects and bundle and enhance public relations efforts within and beyond TUM. This also includes identifying possible industry partners and explore possibilities for further funding proposals. The project partners (LES, APT, TC1, ENS and TEC) therefore want to establish a new interdisciplinary re-

search platform. Thematic key aspects are superordinate system considerations and the two main technologies involved: electrolysis and synthesis. System considerations include the investigation and modelling of future energy systems focusing on power, heat, gas and hydrogen markets in Bavaria, Germany and Europe and their linking. Furthermore, studies on stationary and dynamic storage technology concepts are required to investigate the potential for chemical excess power storage. Electrolysis technologies are evaluated and investigated focusing on fundamentals as well as specific key aspects such as kinetics and permeability of hydrogen and oxygen or efficiency increase of the electrolysis unit through utilization of innovative materials. Also commercial stacks, e.g. PEM and alkali electrolysis units are evaluated and tested with respect to their dynamic behavior in collaboration with ZAE Bayern. Research on chemical synthesis of storage media starts with fundamentals such as the reaction kinetics of CO and CO₂ methanation at stationary and dynamic conditions. These basics are then applied to small-scale test facilities and elaborate system modeling and employed to assess the scale-up potential of the technology as well as chemical engineering and reactor design challenges. Heat removal of the exothermal reaction for example plays an important role for later implementation in real world PtG-plants. In the end, this research leads to a more fundamental understanding of dependencies and key aspects, further research demands and the reproduction of the integrated design process from the chemical basics to the industry-scale application.

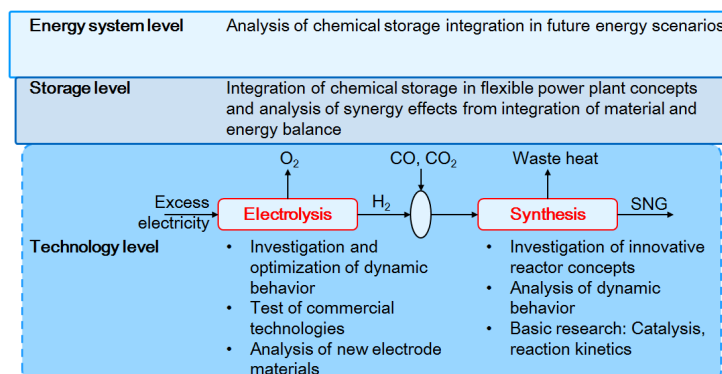

Analysis of a Sailwing concept for Wind Turbine

Julie Piquee^{a*}, Benoit Beguin^a, Christian Breitsamter^a, Nikolaus Adams^a

^a Institute of Aerodynamics and Fluid Mechanics, Department of Mechanical Engineering

*julie.piquee@aer.mw.tum.de

Based on results obtained within a recent research project named α Development and Analysis of an Elasto-flexible Morphing Wing Configuration, the purpose of the ongoing project α Analysis of a Sailwing concept adapted for Wind Turbine is to study the advantages of a sailwing concept in the wind energy sector. The sailwing concept is an elasto-flexible membrane wrapped around a wing structure. It consists basically of a rigid profiled leading-edge spar and a rigid trailing-edge around which an elasto-flexible membrane is enveloped. The aerodynamics of a sailwing is dominated by the aeroelastic phenomena caused by the fluid/structure coupling between the incoming flow and the membrane. The geometry of the leading edge and the elasticity/flexibility of the membrane are important parameters for the aerodynamic performance of the wing. In fact, the cross section of the leading-edge has a significant influence on the pressure distribution over the wing. It was found that the use of a double elliptical profile for the leading-edge permits a reduction of a high pressure gradient increase which facilitates flow separation. Furthermore, the elasticity/flexibility of the membrane appears to significantly control the deformation of the curvature of the wing, which affects directly the aerodynamic characteristics. The deformation leads to an increase of the slope of the lift curve with the angle of attack as well as a mitigated stall behavior. The stall appears later and smoother compared to characteristics rigid wing. As the aerodynamic performance of a sailwing can be compared to that of a rigid wing, the concept becomes interesting concerning wind energy sector. A sailwing appears easier to produce and it is supposed that the structural loads created by a sailwing are lower than loads created by a full ri-

gid wing. The weight should be reduced, which should alleviate the structural loads. As the wing energy sector expansion is bound to happen, new technologies are in development in order to facilitate it. Therefore, the sailwing concept proposes an original technology, which should lead to a reduction of production cost by a structural loads reduction. In order to assess the potential performance of a sailwing rotor, simulations were undertaken at the Technische Universität München with the open source program Qblade. The performance of a given sailwing rotor design was compared to one of a reference rotor (AOC 15/50) using the Blade Element Theory. It was found that when the rotors have a similar maximum power coefficient, the sailwing rotor shows no performance deficit. On the one hand for low tip-speed ratio, it reaches much higher C_p values due to the large camber resulting from the flexible membrane, whereas on the other hand for high tip-speed ratio, its C_p curve drops faster. As the idea stays interesting, the fluid/structure interaction, which plays a key role, has become a new focus in the project. In order to deeply understand the coupling between fluid/structure, an analysis of this interaction is undertaken by a Fluid Structure Interaction method at the Technische Universität München. The aerodynamics and structural characteristics of a three dimensional wing are obtained by this method, which couples a Finite Element Method and a Computational Fluid Dynamics method. As the simulations are still in progress, the oral presentation will give more details about the specific characteristics of a three dimensional sailwing and discuss a potential application as an innovative blade for wind turbine.

Combined Heat and Power - Utilization of Geothermal Heat in ORC Processes

Dominik Meinel^{a*}

^a Lehrstuhl für Energiesysteme, Fakultät für Maschinenwesen

*dominik.meinel@tum.de

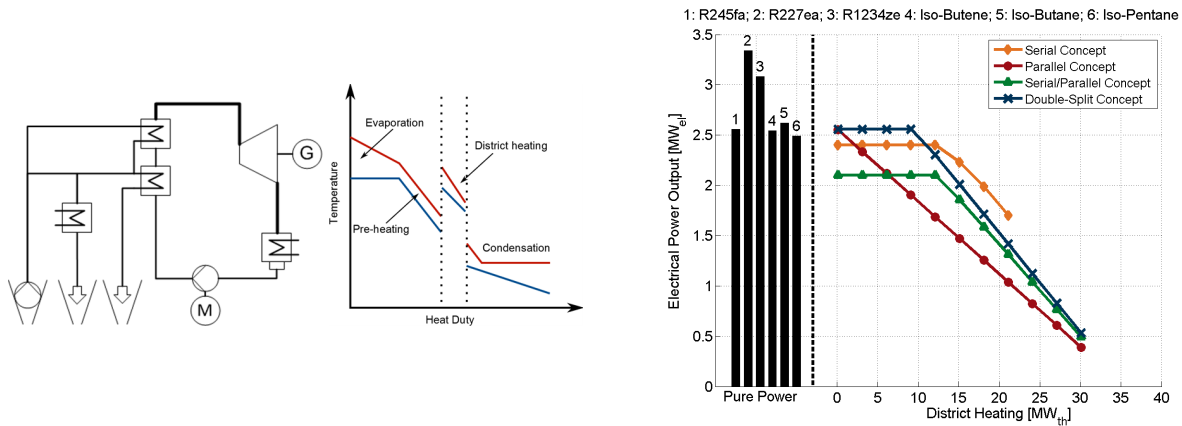

Promoting renewable energy sources by state-funded subsidies for example, also pushed the utilization of geothermal heat. Geothermal heat excels by base-load capability, low CO₂ emissions, worldwide distribution of exploitable hot spots and the potential to satisfy the world energy demand. State-of-the-art in utilizing low-temperature geothermal sources, which are not suitable for direct or flash processes, is the Organic Rankine Cycle (ORC) and the Kalina technology. In order to increase the utilization efficiency of the thermal water, simultaneous generation of heat and electricity is a promising approach. Next to the flexibility of Combined Heat and Power (CHP) plants, state subsidies, the current low stock prices for electricity as well as the objective of increasing the share of CHP power to 25% of the total generated net power in 2020 in Germany are aspects for a distinct research in this field [1]. Investigated CHP Configurations Figure 1 presents the investigated double-split CHP configuration with a standard ORC as the power generation unit. Furthermore, a qualitative TQ-diagram of the process is shown. The proposed system is compared to basic serial-connected, parallel-connected and serial/parallel-connected CHP concepts. The flow connectivity of the double-split design is expected to benefit (a) a decreased ratio of thermal water extraction from the production well in order to satisfy the heat demand. Furthermore by setting an optimal split ratio, the design benefits (b) lower exergy destruction due to a better match of the tempera-

ture profiles and (c) higher utilization efficiencies of the thermal water. Thermodynamic and Economic Results In this study, the thermodynamic and economic performance of three CHP concepts, operated by several organic media, is focused. The operating parameters in the ORC of the heat-led CHP systems are optimized in terms of maximum power generation. From a thermodynamic point of view, the double-split concept benefits higher power outputs particularly at low amounts of decoupled heat as observed in Figure 2. In the diagram, the electrical power outputs of the pure power plants (black bars) and of the CHP concepts, exemplary shown for R245fa, are presented. Furthermore by extracting a defined amount of thermal water, as illustrated in Figure 1, in order to satisfy the heat demand of the heat grid, higher energy utilization efficiencies by decreasing the reinjection temperature of the thermal water can be obtained. Next to thermodynamic considerations, an economic analysis of the systems is carried out. The benchmark of this study is the specific costs per kilowatt hour of generated energy. The double-split design performs best among the considered systems due to the enhanced thermodynamic performance in conjunction with hardly increased investment costs.

[1] Arbeitsgemeinschaft für sparsamen und umweltfreundlichen Energieverbrauch e.V., 'Das KWK-Gesetz 2012 - Grundlagen, Förderung, praktische Hinweise', Energiedruck, Essen. (in German)

2 Poster presentations

Operational range extension of gas turbine combustion by means of water injection and fuel activation

Max Baumgärtner^{a*}, Stephan Lellek^a, Nicolai Stadlmair^a

^a Institute of Thermodynamics, Department for Mechanical Engineering
*m.baumgaertner@tum.de

In the near future atomic power plants are gradually shut down as well as renewable energy sources are increasingly implemented. Both is enforced by energy policy. This however leads to technical challenges for combined cycle power plants running on natural gas. The fluctuating energy output of the renewable sources needs to be balanced by the conventional power plants. Therefore an increase in flexibility of the gas turbine power plants is required. In this context the extension of the operational range of the combustion is one core topic. Conventional methods like staged fuel use and reduced air intake to lower the output are exhausted. Water injection to increase the output is widely used but still not fundamentally understood. One recent approach to extend the range to lower loads is the partial conversion of natural gas to syngas prior to the combustion process. Syngas exhibits lower lean blow out limits and enhances combustion stability. Therefore the operational range of gas turbines is extended to leaner combustion and lower loads. Syngas production faces several constraints: Firstly, the temperature of the syngas should be moderate, so premixing with air is possible. Secondly, the pressure drop of the production process should be low to limit engine efficiency losses, and finally the residence time in the syngas reactor should be in the range of the combustion process itself to limit reactor size. These requirements are met in an auto-thermal reforming process, which combines endothermic steam reforming with the heat release of an oxidation process. For peak load scenarios, however, power output of gas turbines needs to be increased. Water injection in gas turbine combustion chambers has widely been used for this purpose. As liquid water is introduced directly into the combustion chamber, this part of the engine is influenced most. Therefore water injection in gas turbine combustion chambers is in-

vestigated at the Lehrstuhl für Thermodynamik. The quantitative influence of liquid water on the position and shape of the heat release zone as well as on the NO_x emissions of the flame for lean combustion in a swirl combustor are investigated. In a second step, these results will be used to improve the performance of the combustion chamber. The power output of the combustion chamber shall be maximised while NO_x emissions are reduced. For high load conditions thermoacoustic instabilities need to be analysed and understood to prevent hardware damage. These instabilities arise from the coupling of the combustion chamber acoustics with the heat release of the flame. Influences of water injection on the flame dynamics are investigated for different operational parameters. The combustor design is optimised in terms of combustion stability using the results from the first step. The assembly of a technical demonstrator for the in-situ syngas production with an advanced heat concept is currently in progress. The technical feasibility of the process itself and its effectiveness should be shown experimentally. As mixtures of natural gas and syngas show a different combustion behaviour compared to pure natural gas, combustion of these gas mixtures is investigated using a combustion chamber test rig with optical access. In order to guarantee a steady low emission combustion for operation with syngas and natural gas, a fuel flexible burner has to be employed. Measurements for combustion with water injection are also carried out at this test rig. A gas analyser is available at the test rig to measure global and local NO_x emissions of the flame. The acoustic behaviour of the combustor is analysed using dynamic pressure data. Furthermore a computational fluid dynamics tool is used to clarify the flow conditions in the combustion chamber and a kinetic toolbox is used to investigate different reaction mechanisms in the flame.

Network Design and Yield Optimisation of Solar District Heating Systems for Urban Applications

Daniel Beckenbauer^{a*}, Vicky Cheng^b, Wilfried Zärner^a

^a TUM Applied Technology Forum, Institute of New Energy Systems, Technische Hochschule Ingolstadt

^b Munich School of Engineering, Technische Universität München

*daniel.beckenbauer@thi.de

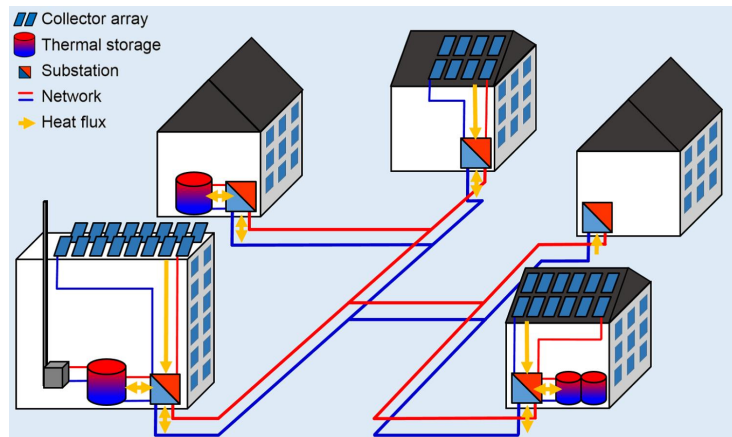

Multi-storey residential buildings provide high potential for solar-assisted local district heating. Current research projects focus on the utilisation of large seasonal storages to achieve a solar fraction of above 50%. However, for retrofitting densely built-up urban areas, the feasibility of solar district heating is often restricted by the limited space available for collector arrays and heat storages. Moreover, high storage capacities come with high investment and heat production costs. These drawbacks impede the applications of seasonal storage concepts in existing urban areas and hinder the dissemination of large solar-thermal systems. This project aims to tackle these challenges by investigating a novel solar district heating design based on distributed solar collector arrays and thermal heat storages in multi-storey residential buildings with bi-directional heat distribution capability. The study will examine the network design and yield optimisation of such a system in various urban contexts. The study will start with a literature review of the state-of-the-art in solar district heating research, particularly in relation to the simulation and optimisation methods. Subsequently, a simulation model will be set up based on typical properties of the investigated system type. The most promising design of the heat network in terms of grid architecture, dimensioning and positioning of the storages and the solar collector arrays will be determined by using mathematical optimisation algorithms. The novelty of the proposed solar thermal systems lies on the concept of bi-directional heat distribution which allows flexible responses to the concurrent heat demands

of buildings in the heating network. The bi-directional property enables storages in buildings with a lower heat demand to supply to buildings with higher demand in the heating network. In addition, solar-thermal energy can be transferred from the collector arrays to storages and consumers anywhere in the heating network and the network itself can act as short-term buffer. For an appropriate operation of this novel system, a smart control unit using self-learning strategies will be implemented. The controller will adapt to the system behaviour and typical consumption profiles to predict the optimal heat distribution and generation. To support this function, the project will also investigate the use of weather forecasts for prioritising solar heat and avoiding unnecessary heat generation by auxiliary sources (such as gas and oil). The modelling approach will be validated with an existing solar district heating system in a case study housing development in Ingolstadt and a model-based sensitivity analysis will be carried out to examine the impacts of various system parameters (e.g. number of buildings, heat demand, climate conditions etc.). The findings of the study will show whether the intelligent interaction of the system components can adequately compensate for the lack of storage capacity as compared to the seasonal storage concepts. The outcome of the project can contribute to the realisation of renewable heating systems with low solar heat costs in combination with a decent solar fraction. Based on the results of the study, general design guidelines will be developed which can help to facilitate solar district heating concept in existing urban areas.

Preparation, structure and characterization of amorphous as well as crystalline macroporous germanium thin films assembled from Zintl clusters

Manuel Meinrad Bentlohner^a, Michael Giebel, Sebastian Geier^a, Benjamin Mandlmeier^b, Kuhu Sarkar^c, Sigrid Bernstorff, Patrick Zeller^d, Benedikt Stoib^e

^a Prof. Dr. T. F. Fässler, Department for Chemistry, TUM

^b Prof. Dr. T. Bein, Department for Chemistry, LMU

^c E13, Institute of Functional Materials, Department of Physics

^d Prof. Dr. J. Wintterlin, Department for Chemistry, LMU

^e Prof. Dr. M. Brandt, WSI

*Thomas.Faessler@lrz.tum.de

M. M. Bentlohner, M. Giebel, S. Geier, B. Mandlmeier, K. Sarkar, S. Bernstorff, P. Zeller, B. Stoib, P. Müller-Buschbaum, J. Wintterlin, M. S. Brandt, D. Fattakhova-Rohlfing, T. F. Fässler* Non-oxide semiconducting materials like silicon and germanium show a broad variability in their structures and electronic properties. Therefore both elements are well suited for application in inorganic-organic hybrid solar cells.[1,2] Based on the controlled oxidative decomposition of Zintl-clusters, in the presence of a template structure, we succeeded to prepare amorphous germanium thin films adapting an inverse opal structure. Our synthetic protocols utilize Zintl-clusters as precursors for the facile formation of complex germanium morphologies. Besides, phosphor containing compounds like phosphines and phosphides are utilized to introduce phospho-

rous into the germanium networks. We further developed annealing conditions, which are suitable to convert the amorphous germanium networks without destruction of the inverse opal structure to crystalline Ge. Crystallization of the amorphous germanium networks is evidenced by Raman spectroscopy and X-ray diffraction techniques (XRD). Scanning electron microscopy (SEM) techniques and grazing incidence small angle X-ray scattering (GISAXS) were applied to study the morphology of our films. X-ray photoelectron spectroscopy (XPS) and energy dispersive X-ray spectroscopy (EDX) were used to investigate the composition of the obtained networks. Band gaps of the films were determined by photothermal deflection spectroscopy (PDS).

[1] M. D. McGehee, MRS Bulletin 2009, 34, 95-100.

[2] A. Stein, Nature 2006, 441, 1055-1056.

Battery production at IWB

Nicolas Billot^{a*}, Till Günther^a

^a Institute for Machine Tools and Industrial Management, Department of Mechanical Engineering

*nicolas.billot@iwb.tum.de

The energy transition and the trend towards electromobility require reliable and cost-efficient energy storage. Electrochemical storage units based on lithium-ion technology constitute a very promising medium-term solution. However current battery systems do not reach the requirements in terms of price, energy density or durability needed for long-term success. Since manufacturing has a considerable impact on the cost and quality of battery cells, the improvement of production processes can significantly contribute to achieve the goals set above. Moreover, the process chain of cell pro-

duction is very complex and requires extensive examination. For these reasons, scientifically investigations of the entire production chain are of highest importance. Electrode production particularly demonstrates the interdependence between manufacturing, battery costs and quality. At the Institute for Machine Tools and Industrial Management (iwb) a new electrode production laboratory was implemented to increase process knowledge and enable a holistic investigation of the entire production chain for lithium-ion cells.

Wind turbine design at Lehrstuhl für Windenergie

Pietro Bortoletti^{a*}, Carlo L. Bottasso^a

^a Lehrstuhl für Windenergie, Maschinenwesen

*pietro.bortolotti@tum.de

The design of wind energy systems is a complex engineering activity that typically aims at delivering the lowest possible cost of energy. This figure of merit captures a wide variety of characteristics of any given solution, including its efficiency at producing energy, the costs of material and manufacturing of all components and sub-components, the costs of transportation and installation, of maintenance and operation, of disassembly and disposal, etc. The problem is also highly constrained, as many requirements have to be met for a variety of reasons, and that result in complex limits and bounds to most design variables. The inherent multi-disciplinarity of the design activity, and the intricate couplings amongst design variables, renders the problem extremely challenging and labor intensive. The Wind Energy Institute works on the development of automated multidisciplinary design software tools, with the goal of enabling the design of wind turbines, the effective exploration of the design space, the understanding of design trade-offs, as well as the evaluation of the impact of new technologies. In this research frame, a primary goal is to develop an optimization process for the design of wind turbine rotors. Currently, distinct optimization loops exist for the aerodynamic and the structural design optimizations. This is also the common practice in industry, where separate engineering teams work iteratively investigating a solution. This practice hides many potential problems, primarily due to the fact that the two optimization loops find local minima for the figure of merit at opposite design solutions. Indeed, the purely aerodynamic optimum design of the blades requires a very low rotor solidity, a high value for the rotational speed and ve-

ry efficient and thin airfoil profiles along the span of the blades. On the exact contrary, the purely structural optimum design of a blade favors high chords and thick or flatback airfoil profiles to achieve higher bending and torsional stiffness values. An incomplete or wrong understanding of these principles may lead to dramatically higher values of the cost of wind energy. Ongoing research activities at the Wind Energy Institute aim at developing an integrated aero-structural optimization that includes the aerodynamic shape optimization, the evaluation of the relevant load conditions and the optimal sizing of the structural configuration, considering the mutual couplings between the various sub-disciplines and simultaneously accounting for the presence of several design constraints. Different optimization procedures are being investigated. An initial possibility is a parametric study where a family of rotors characterized by different aerodynamic performance is created. The different designs go then through a subsequent structural optimization and a final evaluation of the cost of energy. Assuming that the family of blades lays in a representative field of solution, this procedure allows for a good identification of the global minimum for the cost of energy. An ongoing study also intends to have an automatic loop that evaluates the aerodynamic parameters through an evolutionary algorithm, which may converge even in presence of strong discontinuities typical of the aerodynamic shape optimization. Research is finally focusing on the integration in the optimization loop and on the improvement of a FEM analysis of the rotor blades to achieve a highly detailed structural design.

An evaluation of the CO₂ savings potential through energetic coupling of electric vehicles and building energy systems

Bernhard Brendle^{a*}, Thomas Hamacher^c, Markus Lienkamp^a, Christian Wilhelm^b, Jens Papajewski^b

^a Lehrstuhl für Fahrzeugtechnik, Fakultät für Maschinenwesen

^b Audi AG

^c Lehrstuhl für Energiewirtschaft und Anwendungstechnik, Fakultät für Elektrotechnik und Informationstechnik

*bernhard.brendle@gmx.de

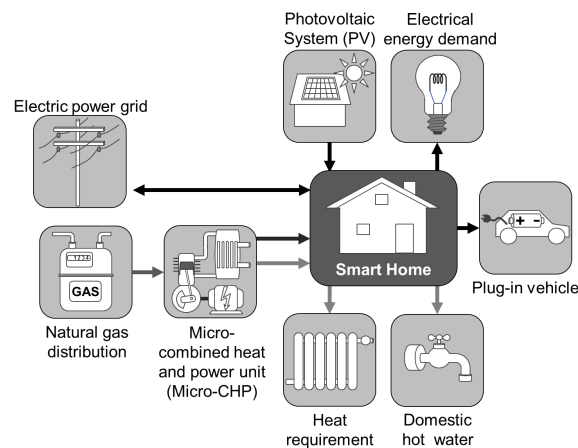

Topics like the reduction of CO₂ emissions and energy consumption are currently more important than ever before. Particularly in private households innovative heating systems, novel insulating materials and smart high-efficiency electrical consumers are used in order to save energy and reduce greenhouse gas emissions. In parallel, research and development of the automotive industry is working on more efficient automobiles with alternative drive train systems. The target is developing cars with fewer emissions and less energy demand such as hybrid and electric drives which enable driving without local CO₂ emissions. [1] However, in this regard almost all approaches aim at reducing the energy consumption and the emissions in just one of both fields, buildings or mobility. By considering both subareas as a combined holistic system, there is further energy saving potential with respect to the total energy demand due to synergetic effects. [1] Current research projects regarding Smart Homes and Vehicle to Building (V2B) are already combining buildings and vehicles electrically and are integrating electric vehicles into the domestic electric installation. However, the primary goal of these endeavors is to smooth the load profile on a household level rather than to reduce the CO₂ emissions and the individual-related total energy consumption. This means that by using an intelligent control of charging and discharging of the electric vehicles, the buildings load profile can be adju-

sted to the electricity supply of the electric utility, the overall energy demand, however, remains equal. [1][2] In contrast to this, the present work aims at showing the total CO₂ emissions of vehicle-building constellations and the corresponding saving potentials. For different driving energy needs the total energy requirement of vehicle-building constellations is examined and thus their CO₂ emissions are determined. The investigated constellations vary in terms of technical implementation and thus indicate the emission reduction potential of various measures. Measures mean for example, modernization that is currently widely used to upgrade buildings energetically. One example of this is an improved building insulation. Other measures are the installation of technical components, such as a photovoltaic system or a combined heat and power unit. Especially the combination of stationary building energy systems together with an electric vehicle is examined and so the emission reduction potential of coupled systems or rather the holistic potential of buildings and vehicles is identified.

[1] Brendle et.al.: A simulation model for a smart home and vehicle to building applications, 1st Colloquium of the Munich School of Engineering, München, 2011

[2] Brendle et.al.: 'Living and Mobility - Minimization of the Overall Energy Consumption by Using Synergetic Effects and Predictive Information. SAE Technical Paper 2012-01-0496, 2012

The energy saving potential of vertical greenery systems in buildings

Andika Citraningrum^{a*}

^a Lehrstuhl für energieeffizientes und nachhaltiges Planen und Bauen, Department of Architecture

*andikacitra@yahoo.com

The increased energy consumption from the building sector has become a worldwide awareness. With the current warming of Earth temperature, continued emissions of greenhouse gases as a consequence of the high energy utilization will contribute to a further climate change. Higher temperatures are aggravated in cities by the urban heat island effect, in which city becomes several degrees warmer than the surrounding rural regions due to the built environment and the concentration of human activities [1]. The higher temperature increases the demand for air conditioning, which pumps more waste heat into the environment, increasing the heat island. Three commonly suggested strategies to mitigate the heat island effect are by using vegetation, green roof, cool roofing, and cool pavements [2]. Bass et al. [3] also noted that reducing the building envelope temperature would further bring down the use of energy for space conditioning. Due to the hot building envelope, the temperature of the external air that is brought onto the building ventilation system may be warmer than the ambient air, requiring additional energy for cooling. Evapotranspiration and shading from the vegetation could cool the building envelope. The cooler building envelope would also reduce the temperature of the external air that is exchanged with the buildings air. With the increasing concern on limited ground area for planting, there is a pressing need for an innovative way of greenery to overcome the constraints of open space deficit in urban housing development. The beneficial values of roof gardens have drawn substantial attention since the late 1990s. Unfortunately, land scarcity and dense population have sent the residential buildings to go high rise, which limited the effectiveness of roof garden as an ur-

ban greening measure. A large proportion of rooftop is occupied by utility devices, resulting in very little space for greening. Recently, the popularity of vertical greenery is growing in the context of urban landscaping because of its smaller footprint, aesthetic value and heat island mitigation impact. Vertical planting is a good alternative to roof greenery in a city composed of tower blocks which have high wall-to-roof ratio, and consequently large potential surface area for greening. Vertical greenery systems have been the features of architectures for centuries where it is a common practice to grow climbers on the exterior walls of buildings. The technical idea of vertical greenery systems was based on the fact that certain plant like orchids do not depend on soil and can be applied to urban scenes. The community will benefit if a vegetated cladding on building can exhibit the efficacy of a green roof. This paper will review the typology of vertical greenery systems, the mechanism by which it can be used as a means to reduce energy consumption, and its potential in energy saving in buildings.

[1] Hutchins, Amy. Climate change and green roofs the example of three cities. Accessed on 4 December 2013. <http://www.biotope-city.net/article/climate-change-and-green-roofs-example-three-cities>.

[2] US EPA. 2008. Reducing Urban Heat Islands: Compendium of Strategies (Urban Heat Island Basics). <http://www.epa.gov/hiri/resources/pdf/Basics-Compendium.pdf>

[3] Bass, B.; Liu, K. K. Y.; Baskaran, B. A. 2003. Evaluating Rooftop and Vertical Gardens as an Adaptation Strategy for Urban Areas. NRC Institute for Research in Construction; National Research Council Canada.

Influencing the morphology of organic thin films for application in photovoltaics via a mechanical approach

Mihael Coric^{a*}, Stephan Pröller^a, Leonhard Hofbauer^a, Eva Herzig^a

^a Herzig Group, Munich School of Engineering

*mihael.coric@tum.de

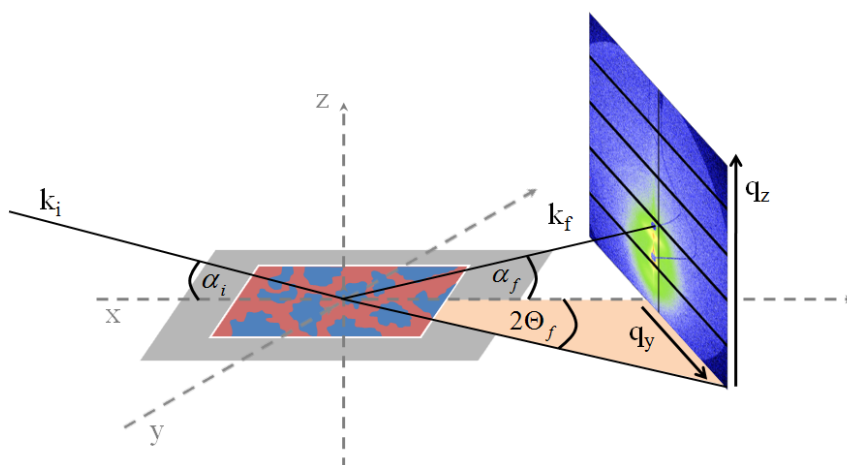

Organic photovoltaics have a lot of advantages compared to conventional silicon solar cells. Organic solar cells can be processed on flexible substrates making their usage accessible to a vast range of areas like the implementation in clothes, bags or even windows. Roll-to-roll processes enable the production of organic solar cells in large scales which induce low production costs and a high output production. Nevertheless the usage of organic solar cells is not yet efficient enough to compete with conventional inorganic solar cells. One crucial point is the control of the active film morphology. Interdigitated phase-separated domains are key features for an efficient charge dissociation and charge collection. There are various methods to achieve control over the morphology like temperature annealing, solvent annealing [1] or the right choice of solvent. [2] These methods enable beneficial change of the active film morphology, but are only useful in tuning the morphology to a certain extent. Therefore this work will emphasize a different approach. The goal is to produce films out of melted polymers. This approach enables new opportunities to tune the morphology mechanically. Through mechanical influence like stretching or shear forces certain polymeric orientations which benefit charge transport can be achieved. It is possible that through the mechanical influence on the polymeric alignment a strained state can be achieved, decreasing orbital distances between the polymeric chains result-

ing in higher charge carrier mobility. [3] The control of the morphology has to be verified and quantified. This can be done by various scattering methods, which offer a non-invasive experimental method to get an insight into the blend morphology. One example for a scattering method that is going to be used in this work is grazing incident small-angle X-ray scattering (GISAXS). GISAXS measurements allow penetrating the thin organic films enabling to examine structural sizes in the range of 20 nm to 1000 nm, revealing domain sizes and phase segregation of the different materials within the active film, allowing a tracking of the substantial changes in the morphology. The combination of a new approach of manufacturing organic solar cells and the investigation of morphology control induced through different scattering methods will deepen the understanding of the key features that are important when looking at a large-scale production.

[1] C. R. McNeill, *Energy and Environmental Science* 5, 5653 (2012)

[2] M. A. Ruderer, S. Guo, R. Meier, H.-Y. Chiang, V. Köstgens, J. Wiedersich, J. Perlich, S. V. Roth, and P. Müller-Buschbaum, *Advanced Functional Materials* 21, 3382 (2011).

[3] G. Giri, E. Verploegen, S. C. B. Mannsfeld, S. Atahan-Evrenk, D. H. Kim, S. Y. Lee, H. A. Beceril, A. Aspuru-Guzik, M. F. Toney, and Z. Bao, *Nature* 480, 504 (2011)

Origin of diffusion Related Losses in Alkaline Membrane Electrode Assemblies (MEAs)

Ibrahima Diallo^{a*}, Julien Durst^a, Hubert Gasteiger^a

^aTechnical Electrochemistry, Department of Chemistry

*ibrahima.diallo@tum.de

In the upcoming year, several automakers are slated to release Polymer Electrolyte Membrane (PEM) fuel cell powered cars. This has been made possible by over twenty years of research and development centered mainly on reducing the amount of Platinum group metal (PGM) catalyst used in the electrodes. The required amount having been reduced from 1 g/cm² to less than 0.2 mg/cm² for the Oxygen Reduction Reaction (ORR) on the cathode, and less than 0.04 mg/cm² for the kinetically very rapid Hydrogen Oxidation Reaction (HOR) [1]. However, there is a lower limit to the reduction of the expensive PGM catalysts. The alkaline electrolyte membrane (AEM) fuel cell promises to enable the altogether replacement of the PGM catalysts with cheaper and more abundant catalysts, like Nitrogen coordinated Iron and/or Cobalt [2,3]. Despite its infancy, much progress has been made in the development of novel ionomers and membrane polymers that enable ionomer-bonded alkaline MEAs (membrane electrode assemblies). These MEAs in operando

show voltage losses in the traditionally Ohmic controlled regions that do not arise from Ohmic resistance alone. In this work, we put forth our investigations on the effects of ionomer to carbon ratio on the quality of the catalyst ink and performance, and we try to elucidate the sources of the losses in the Ohmic zone by investigating the behavior impedance in the system under varying relative humidity conditions [4].

[1] K.C. Neyerlin, W. Gu, J. Jorne, H.A. Gasteiger, Study of the Exchange Current Density for the Hydrogen Oxidation and Evolution Reactions, *J. Electrochem. Soc.*, 154 B631-B635. (2007)

[2] H. Meng, F. Jaouen, E. Proietti, M. Lefevre, and J.P. Dodelet, *Electrochem. Commun.*, 11, 1986 (2009)

[3] M. Piana, S. Catanorchi, and H.A. Gasteiger, *ECS Trans.*, 16(2), 2045 (2008)

[4] Y. Liu, M.W. Murphy, D.R. Baker, W. Gu, C. Ji, J. Jorne, and H.A. Gasteiger, *Journal of The Electrochemical Society*, 156 (8) B970-B980 (2009)"

Integration of Micro-CHP Systems in Smart Homes

Wessman El-Baz^{a*}, Peter Tzscheutschler^a

^a Lehrstuhl für Energiewirtschaft und Anwendungstechnik, Fakultät für Elektrotechnik und Informationstechnik
^{*}wessam.elbaz@tum.de

Smart homes are one of the main approaches for an automated demand-side management (DSM) application. This automation can only be achieved through the energy management system (EMS) deployed within the smart home. The EMS load shifting strategy could be serving several goals. It could be targeting minimizing CO₂ emissions, peak load shaving, minimizing energy costs, or maximizing the use of the in-house energy sources (e.g., PV). Yet, the major driving factor behind EMS application is financial incentives. The financial incentives presented by the grid encourage customers to shift their loads to the cheapest hours, also to rely on the in-house renewable energies and micro combined heat and power (micro CHP) systems supplies to satisfy their demand, or to export the excess energy to the grid. Already today micro CHP systems based on different prime movers as internal combustion engine (ICE), Stirling engine or fuel cells which are available in the market. By integrating a heat buffer storage along with a micro CHP in a smart home a decoupling between heat demand and power production can be achieved offering a certain level of flexibility and potential to generate power on demand. In the li-

terature, several EMS approaches and strategies were presented that aim towards an efficient electrical load DSM, and consequently the advantage of heat and electricity co-generation of a micro CHP system wasn't efficiently exploited. Micro CHPs could serve most of the DSM strategies due to its modulating behavior. Also, its high availability increases the potential of integration of electrical vehicles within smart homes. Yet, an efficient economic integration of micro CHPs means that a maximum use of both heat and electricity generated shall be achieved. Thus, an additional complexity is piled on the DSM control strategy of the EMS. Through this contribution, an overview will be introduced about the different types of micro CHPs and their behavior, which make their control strategy within an EMS variable. Furthermore, a comparison between centralized and decentralized control methods of an EMS will be presented to show out the adaptability of both methods to the integration of various types of micro CHPs. In addition to that, an analysis will show out the economic potential of the integration of the current micro CHP technologies within the smart homes under different operation scenarios.

Electrochemically Active Surface Area and H₂-Oxidation Activity Determination of Pd-Based Electrocatalysts in Alkaline Media

Tobias Greese^{a*}, Gregor Harzer^a, Juan Herranz^a, Frédéric Hasché^a, Julien Durst^a, Hubert Gasteiger^a

^a Institute of Technical Electrochemistry, Department of Chemistry

*tobias.greese@gmx.de

Proton exchange fuel cells are promising systems for the conversion of energy potentially produced out of renewable sources and, in a near future, could be used by the automotive sector to substitute combustion engines which are still running on fossil fuels. Nevertheless, one of the main drawbacks of this technology is the high cost per device, mostly caused by the need for noble metals as the catalysts for the hydrogen oxidation and oxygen reduction reaction (HOR and ORR, respectively) which take place at the anode and cathode electrodes, respectively. For proton exchange membrane fuel cells (PEMFC), in particular, Pt and its alloys provide the highest activity as catalysts at the same time being the most expensive of the noble metals, though. Alternatively, alkaline membrane fuel cells are attracting increasing interest due to the possibility of using inexpensive, noble-metal free based electrodes. However, while similar reaction rates are found for the ORR when comparing Pt-based catalysts in acid and noble-metal free electrodes in alkaline electrolytes, it has been shown recently that the HOR on Pt-group metals is approx. 100-times slower in alkaline electrolyte than in acid [1]. Therefore, the development of cost effective alkaline fuel cells relies on the development of highly active HOR catalyst in high pH electrolytes. A plausible alternative to platinum-based catalysts could be Pd-derived ones, since this noble metal is typically 2-3 fold less expensive than Pt [2]. More precisely, Pd-M alloys would be of particular interest due to the trend of Pd to segregate towards the surface of an alloyed metal system, therefore increasing the Pd-mass specific electrochemically active surface area (ECSA) and catalytic activity

[3]. Therefore, the development of electrochemically-based procedures to assess the surface composition and ECSA of these alloys is of crucial importance to the understanding of the properties that govern their catalytic behavior and, ultimately, to the development of better-performing materials. With this motivation, we prepared different carbon-supported PdNi_x (x = 1, 3, 6) alloy nanoparticles and used rotating-disc electrode voltammetry in H₂-saturated, 0.1 M NaOH to quantify their activity for the HOR in alkaline electrolyte. Moreover, we also applied CO-stripping voltammetry as the ECSA-determination procedure, whereby we studied the effect of several parameters, including dosing potential, scan rate and potential window. These results were subsequently compared to those obtained with carbon-supported, Ni-free Pd nanoparticles with different particle sizes. As a result, we propose a route for the determination of the ECSA of Pd-based electrocatalysts and the quantification of their HOR-activity, and show that the addition of Ni is beneficial to the surface-normalized activity of Pd.

[1] W. Sheng, et al., "Hydrogen Oxidation and Evolution Reaction Kinetics on Platinum: Acid vs Alkaline Electrolytes, *J Electrochem. Soc.* 157, 2010, pp. 1529-1536.

[2] M. Shao, "Palladium-based electrocatalysts for hydrogen oxidation and oxygen reduction reactions, *J Power Sources* 196 (2011) pp. 2433-2444.

[3] M. Oezaslan, et al., Pt-Based Core Shell Catalyst Architectures for Oxygen Fuel Cell Electrodes, *J Phys Chem Lett* 4, 2013, pp. 3273-3291.

Thermoelectric properties of meso-porous thin films from laser-assisted wet-chemically doped group-IV nanoparticles

Anton Greppmair^{a*}, Benedikt Stoib^a, Tim Langmann^a, Nils Petermann^a, Hartmut Wiggers^a, Martin Stutzmann^a, Martin S. Brandt^a

^a E25, Walter Schottky Institut, Physik Department
*anton.greppmair@wsi.tum.de

We present recent studies on the morphology and the thermoelectric properties of thin films of laser-sintered group-IV nanoparticles. The structure size of the mesoporous network is in the sub- μ regime and can be controlled by the laser fluence used for sintering. Doping is achieved by immersing the nanoparticle film in a liquid containing the dopants. The dopants remain in the nanoparticle film after drying and are subsequently incorporated in the crystal structure during the sintering step. Conductivity and thermopower measurements provide insight into the doping efficiency and confirm n- and p-type doping. For the doping with

group-V elements we find a threshold concentration, above which the conductivity can be increased by several orders of magnitude using different dopant concentrations in the dopant solution. Adsorption of the dopant atoms to the nanoparticles and diffusion into the film were found to be the limiting processes for the doping efficiency. The doping process was successfully transferred to various SiGe alloy compositions ranging from pure Ge to pure Si. Thermal properties were also investigated by microscopic infrared thermography.

[1] B. Stoib et al., *Physica Status Solidi A* 210, 153 (2012)

Electrochemical characterisation of phosphorus and binary phosphides

Carolin Grotz^{a*}, Daniela Pfister^a, Tom Nilges^a

^a Synthese und Charakterisierung innovativer Materialien, Department of Chemistry

*carolin.grotz@mytum.de

Phosphorus is known in many modifications. One of them is the thermodynamically stable black phosphorus synthesised via mineralization concept from Tom Nilges et al. [1] Due to the high theoretical capacity and the layered structure black phosphorus was tested as electrode material in Lithium and Sodium ion batteries. [2,3] The performance of Na vs. a phosphorus carbon composite is according to Yang et al. 1750 mAh/g after 40 cycles. [3] NaP7 postulated as one intermediate compound during the Na cycling was synthesised in our group and electrochemical characterized with galvanostatic cyclisation and cyclic voltammetry. In situ XRD analysis was performed and first results will be

presented.

[1] M.C. Stan, J. von Zamory, S. Passerini, T.Nilges, M. Winter, Puzzling out the origin of the electrochemical activity of black P as negative electrode material for Lithium-ion batteries, *J. Mater. Chem. A*, 1, 2013, pp. 5293-5300.

[2] C.-M. Park, H.-J. Sohn, Black Phosphorus and its Composite for Lithium Rechargeable Batteries, *Adv. Mater.*, 19, 2007, pp. 2465-2468.

[3] J. Qian, X. Wu, Y. Cao, X. Ai, H. Yang, High Capacity and Rate Capability of Amorphous Phosphorus for Sodium Ion Batteries, *Angew. Chem.*, 125, 2013, pp. 4731-4734.

Enhanced Efficiency by solvent treatment for PTB7:PC71BM Bulk Heterojunction System

Shuai Guo^{a*}, Biye Cao^a, Weijia Wang^a, Jean-Francois Moulin^b, Peter Müller-Buschbaum^a

^a Lehrstuhl für Funktionelle Materialien E13, Physik-Department

^b Institut für Werkstofforschung, GKSS-Forschungszentrum Geesthacht GmbH

*shuai.guo@ph.tum.de

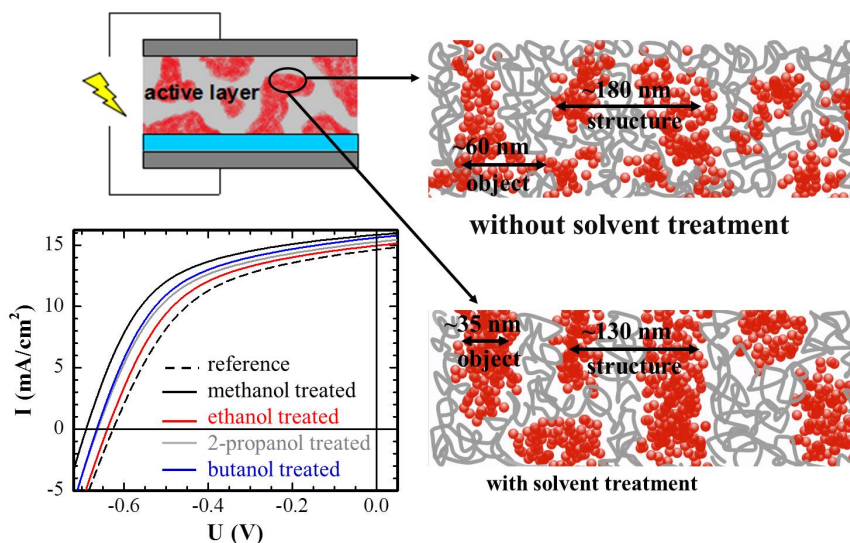

Polymer-based photovoltaics are gaining tremendous attentions both on research and industrial fields in the past decade due to their promising potentials such as low-cost, light weight, and unique flexibility. Power conversion efficiency of polymer-based solar cells has been improved up to 10%, which has passed the threshold of being commercialized. [1] Although simple post treatments to the polymer solar cell such as thermal annealing, solvent annealing, or solvent treatment have been proved to be effective methods to promote the device performance, fundamental knowledge regarding to this aspect is yet to be fully understood. Particularly, solvent treatment can greatly improve the efficiency of PTB7:PC71BM bulk heterojunction (BHJ) solar cells. [2, 3] In this work we investigate thoroughly PTB7:PC71BM BHJ solar cells without and with four different solvents treatment: methanol, ethanol, isopropanol, and butanol treatment, respectively. Despite of the encouraging efficiency provided by this system, most researches only focus on the change of film surface, therefore, the possible changes of the inner film morphology introduced by the solvent treatment are

mostly neglected. Here, we not only investigate the film surface modification of the polymer blend film after solvent treatment, but also significant modification of the inner film of morphology by time of flight-grazing incidence small angle neutron scattering (TOF-GISANS). TOF-GISANS technique gradually becomes a powerful method to probe the depth profiles of solid films and fluidic samples. Consequently, the morphology of all investigated films is determined and compared, directly addressing the reason for the enhanced device performance introduced by solvent treatment. [4]

[1] M. A. Green, K. Emery, Y. Hishikawa, W. Warta, and E. D. Dunlop. *Prog. Photovolt: Res. Appl.*, 2014, 22, 1-9.

[2] H. Zhou, Y. Zhang, J. Seifer, S.D. Collins, C. Luo, G.C. Bazan, T.-Q. Nguyen, and A.J. Heeger, *Adv.Mater.*, 2013, 25, 1646-1652.

[3] L. Ye, J. Yan, X. Guo, H. Sun, S. Zhang, M. Zhang, L. Huo, and J. Hou, *J. Phys. Chem. C.*, 2013, 117, 14920-14928.

[4] S. Guo, B. Cao, W. Wang, J.-F. Moulin, and P. Müller-Buschbaum, 2014, in preparation.

Synthesis of Palladium-Based Alloy Nanoparticles as Electrocatalysts for Hydrogen Oxidation in Alkaline Media

Gregor Harzer^{a*}, Claudia Chomyn^a

^a Technical Electrochemistry, Department of Chemistry

*gharzer@mytum.de

Fuel cell systems are promising candidates to replace fossil fuel based engines for transportation and electric energy generation. The proton exchange membrane fuel cell (PEM FC), which operates at low pH (0) is widely used nowadays but requires large amounts of noble metal at the cathode (Pt-based electrodes) in order to catalyze the sluggish oxygen reduction reaction (ORR) [1]. In alkaline media, the hydrogen oxidation reaction (HOR), the anodic reaction in a fuel cell, shows significant kinetic losses even when catalyzed by Pt electrodes, which could limit the development of future alkaline membrane fuel cell devices [2]. Therefore, advanced catalyst systems with improved activity are required to catalyze electrochemical reactions in alkaline electrolytes. Furthermore, the reduction and/or substitution of platinum as catalyst is still a challenge. In this contribution, we show our recent results regarding the synthesis of palladium based alloy nanoparticles as electrocatalysts for alkaline fuel cells. Palladium is an interesting candidate to substitute platinum as hydrogen oxidation catalyst in alkaline media due to a price advantage. However, efforts need to be made to increase its activity to make this type of fuel cells viable. Alloying palladium with transition metals (e.g. Ni, Cu, Co) is a promising approach to increase the specific activity due to surface effects, like strain or electronic effects. The alloying furthermore allows the use of less palladium, because part of the catalytically

inactive inner portion of the particle is substituted by a cheaper transition metal. Inspired by this possibility, we present different solid and liquid phase methods to prepare carbon supported palladium alloy nanoparticles with defined transition metal contents. X-ray diffraction (XRD), transmission electron microscopy (TEM) and elemental analysis were performed in order to characterize the size and composition of the bimetallic nanoparticles. The HOR activity of these electrocatalysts, compared to commercially available carbon supported palladium catalysts, was evaluated with a rotating disc electrode (RDE) setup in 0.1 M NaOH. The mass based activity for some of the home-made palladium alloy catalysts is increased by more than 50 % compared to the pure palladium counterpart.

[1] Oezaslan, M., et al., Pt-Based Core Shell Catalyst Architectures for Oxygen Fuel Cell Electrodes. *The Journal of Physical Chemistry Letters*, 4 (19), 2013, pp. 3273-3291.

[2] (a) Durst, J., et al., "New Insights into the Electrochemical Hydrogen Oxidation and Evolution Reaction Mechanism. *Energy & Environmental Science*, DOI:10.1039/c4ee00440j, 2014; (b) Sheng, W., et al., "Hydrogen Oxidation and Evolution Reaction Kinetics on Platinum: Acid vs Alkaline Electrolytes. *Journal of The Electrochemical Society*, 157 (11), 2010, pp. B1529-B1536.

Resource Efficiency of Urban Districts - Development of a Method to Improve the Energy- and Material- Efficiency of Retrofit Measures in Urban Districts

Matthias Heinrich^{a*}, Christoph Goebel^a, Hans-Arno Jacobsen^a

^a Chair for Building Physics, Bau Geo Umwelt

*m.heinrich@tum.de

This paper describes the development of a method to assist in the decision making process when planning resource efficient retrofit measures for urban quarters, by considering the interaction between embodied energy and the energy usage during the operational phase. Up until now, energy efficient building retrofit measures only consider the energy usage during a buildings operational phase. This approach is insufficient, as the required embodied energy for the production of building materials, building maintenance and the buildings end of life phase are not considered. To ensure that energy consumption in each life cycle phase is minimised and not offset by the production of building materials, a life cycle approach is required when retrofit measures are adopted. The challenge is to find the most resource efficient solution when selecting retrofit measures from a wide pallet of potential choices, taking into account possible synergies with surrounding facilities in the urban quarter (infrastructure, supply networks, socio-cultural factors). At the completion of this study, a model will be developed, in which, various retrofit strategies for the selected building type (e.g. apartment buildings) will be analysed and com-

pared in terms of their embodied energy over all life cycle stages. For each building type, various parameters (climate, year of construction, condition of building or location within the district) will be defined on which the retrofit measures are based. The models scenarios will be created from a collection of previously selected retrofit- technologies and systems and characterised by their technical-, environmental-, social- and economic-parameters. In particular, new and innovative retrofit technologies, such as renewable energy storage systems, will be analysed in terms of their embodied energy over the entire life cycle. In order to compare the total energy requirement for retrofit alternatives with the demolition of existing buildings, reference scenarios will be also be developed. The method will allow planners to efficiently determine the embodied energy required for retrofit measures based on the selected standard (e.g., net zero energy building). In this way the resource efficiency of retrofit measures for urban districts can be maximized. When completed, the model will be applied on three selected case studies (Frankfurt, Budapest and Santiago de Compostela).

Storage and PV integration in CHP facilities for residential neighborhoods

Simon Herzog^{a*}, Abigail Ondeck^b, Thomas Hamacher^a

^a Institute for Renewable and Sustainable Energy Systems, Department Electrical Engineering and Information Technology

^b McKetta Department of Chemical Engineering, University of Texas at Austin

*simon.herzog@tum.de

Combined heat and power (CHP) facilities are a very promising path to reducing CO₂ emissions and increasing efficiency in the power generation sector, especially when combined with residential solar power generation. CHP facilities rely on natural gas, a cleaner fuel than coal, to generate electricity and hot and chilled water. The ability to supply these essential residential utilities in an efficient way on a medium to large scale opens the path for combining district cooling, heating and power generation. It is suggested that CHP plants are an appealing choice for providing integrated utilities for the neighborhood of the future. However, one problem that stands with integration of large amounts of renewable generation and highly efficient CHP plants is the time gap between production and demand. In the residential sector, the solar power generation electricity demand peaks do not occur at the same time, but electrical and

thermal storage can be used to help shift and match the peaks. The CHP plant with district heating and cooling was simulated with electrical and thermal storage to show the effects of electrical and thermal storage on shifting peak solar power generation to peak electricity and cooling demand. The CHP plant was modeled and optimized using CHP plant data from the University of Texas at Austin and residential energy data from the Mueller Neighborhood, in Austin, TX, provided by Pecan Street Inc. The model, a set of non-linear equations, was optimized to maximize profit, while meeting the heating, cooling, and electrical demands of the Mueller neighborhood. Photovoltaic (PV) generation, obtained using data from the Mueller neighborhood solar cells, was integrated into the CHP plant as a single generation source.

Evaluation of Flexible Power Plants in the Context of the Interconnected Power System

Dominic Hewes^{a*}, Mathias Huber^b

^a Fachgebiet Elektrische Energieversorgungsnetze, Fakultät für Elektrotechnik und Informationstechnik

^b Lehrstuhl für Energiewirtschaft und Anwendungstechnik, Fakultät für Elektrotechnik und Informationstechnik

*dominic.hewes@tum.de

The large-scale expansion of intermittent renewable generation will require higher ramp rates and more frequent cycling of thermal power plants. Current generators are not equipped to accommodate this demand flexibility. Therefore, flexible generator technologies are being developed to meet these challenges. The impact of these generator concepts on the wider power system must be evaluated. The integration of renewables will also challenge the existing control system. It is unclear whether the present control scheme can maintain stability under future system expansion scenarios. To

evaluate these questions, a detailed computational model of the European electricity generation/transmission system is under development. The model will be used to simulate future scenarios with high shares of renewable generation and thereby assess the implications of new flexible power plant designs for the stability of the future power system. The modeling work is divided in two parts: Setting up a techno-economic unit commitment (UC) and economic dispatch (ED) model, and building a dynamic power system model for load flow and stability analysis.

Organic photovoltaic cells: Tuning the nanomorphology of ternary systems with insulating polymer

Leonhard Hofbauer^{a*}, Peter Müller-Buschbaum^b, Harald Oberhofer^c, Eva M. Herzig^a

^a Herzig Group, Munich School of Engineering

^b Lehrstuhl für Funktionelle Materialien, Physik-Department

^c Lehrstuhl für Theoretische Chemie, Physik-Department

*leonhard.hofbauer@tum.de

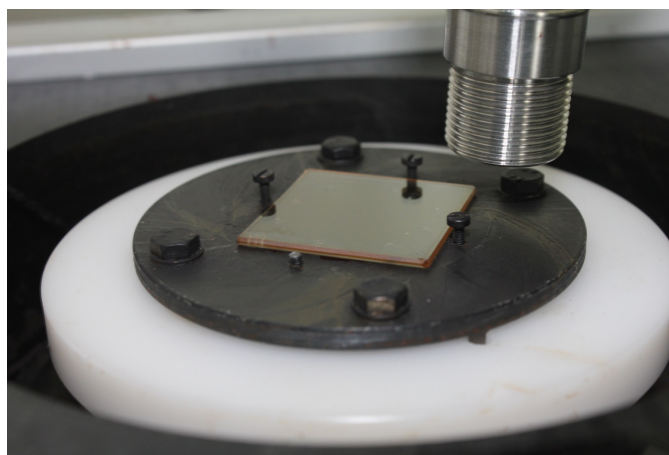

In contrast to silicon photovoltaic systems, the active layer of organic solar cells is made of organic molecules. This makes the production of organic solar cells potentially much cheaper, less energy intensive and more environmentally friendly. In order to benefit from these attractive characteristics and to obtain wide spread application, it is necessary to improve the performance of organic solar cells. One crucial factor for charge separation, charge transport and, therefore, performance is the nanomorphology of the active layer. Consequently, successful methods of tuning the nanomorphology of the active layer are needed to be able to tackle one of the main problems, the lack of sufficient power conversion efficiency. Therefore, it is highly desirable to control the nanostructures of the active layer, which we approach by adding a third organic, insulating component to our two semi-conducting materials. It has been shown that the addition of an insulating polymer of up to 50 wt.% does not necessarily lead to a large decrease in efficiency, but it can even enhance the efficiency per active material used for the ternary layer. [1] Scattering experiments show that the addition of an insulating polymer can have a strong influence on the length scales of the nanostructures in the active layer. [2] Being able to understand and optimise these effects will help to produce solar cells with improved nanomorphology. To achieve this, broader studies on the influence of vary-

ing weight fractions of the insulating polymer on the solar cell efficiency, as well as on the impact of different parameters of post-fabrication treatments, are carried out. For this purpose, we built a heatable chuck, as high-temperature spin coating is required for processing the insulating polymer (Figure 1). Moreover, we further investigate the system to determine the effects of our third component on the crystalline and amorphous parts of the active materials. Hence, we study the miscibility of our insulating component with the semi-conducting material to ascertain the distribution of our components after phase separation. This way we can gain essential knowledge for deeper structural analysis of the ternary blend and, eventually, obtain profound understanding of the beneficial influences of insulating polymers in the active layer. Considering the potential for performance improvements, undertaking further research on the application of insulating polymer ternary blends is a promising pathway to future organic solar cell development.

[1] Toby A. M. Ferenczi, et al., Organic Semiconductor: Insulator Polymer Ternary Blends for Photovoltaics, *Adv. Mater.*, 2011, 23, p. 4093-4097

[2] Ammara Akhtar, Master Thesis, Lehrstuhl für Funktionelle Materialien, Physik-Department, Technische Universität München, 2012

Organic solar cells based on aqueous processed P3P6T/C60 thin films

Nuri Hohn^{a*}, Daniel Mosegui-González^a, Peter Müller-Buschbaum^a

^a E13 - Lehrstuhl für funktionelle Materialien, Physik Department

*nuri.hohn@ph.tum.de

Organic solar cells (OSCs) usually allow for a large scale spray deposition and role-to-role production as well as a flexible, transparent design. Due to the large scale production potential, OSCs offer the possibility for low cost manufacturing and are of major interest for industrial applications. Since sustainability and environmental protection plays an increased role nowadays, especially for industrial nations, tending towards green solar cell production is attracting more and more interest. For this reason the hole conducting polymer Poly[3-(potassium-6-hexanoate)thiophene-2,5-diyl] (P3P6T) is employed in combination with an also water-soluble C60-malonic acid fullerene derivative. This employed system is very well comparable to the profoundly studied P3HT:PCBM system with the exception, that the OSC production process relies on a highly reduced amount of harmful organic solvents. The reduced amount of organic solvents needed to synthesize the OSC, compared to common OSCs, is related to the fact, that the manufacturing process of the active layer is based only on deionized water as a solvent. In pioneering this field of environmental friendly solar cell production, initial experiments concerning layer and morphology optimization are carried out. Differences between a bilayer morphology, where the interface for exciton creation is typically smaller, and a bulk-heterojunction (BHJ) morphology are analyzed.

Furthermore the thin layers of P3P6T and the PCBM derivative are as well deposited via a spray deposition approach as spin coated. Especially during this step many optimizations had to be carried out concerning concentration, spin parameters as well as solvent additives. Concerning the additives, inclusion of potassium hydroxide was performed to allow for solubility of highly concentrated C60 solutions, which were required for a sufficiently thick and spin-coated film. Via tending towards the spray deposition method the concentration of P3P6T/C60 in solution could be lowered and no potassium hydroxide had to be employed, which lowers the possibility for trap states in the active layer. Beyond the optimization of the active layer, the effect of the cell geometry is analyzed, meaning inverted as well as non-inverted solar cells have been studied and compared. In order to further optimize the OSC, different blocking layers have been deposited and their effect on the cells performance have been studied. The different blocking layers include an electron blocking layer made out of PEDOT:PSS as well as an inorganic titanium(IV)butoxide hole blocking layer. Primary investigations address the electrical and spectral characterization, including the comparison of common solar cell parameters, and the morphological characterization via optical microscope, AFM and Dektak.

Modelling residential electricity demand at high temporal and spatial resolution

Akhila Jambagi^{a*}, Michael Kramer^a, Vicky Cheng^a

^a Energy Efficient and Smart Cities group, Munich School of Engineering
*akhila.jambagi@tum.de

To develop strategies for improving the energy efficiency of cities it is important to understand the existing energy use patterns. This poster presents a novel approach for developing an accurate and realistic model of residential electricity demand using the city of Munich as a case study. It is part of a wider project Energy Planning for Munich undertaken by the Energy Efficient and Smart Cities group in exploring ways to make cities more energy efficient and carbon neutral. A necessary property for the model is a flexible time and space resolution, to ensure its ability to evaluate different energy efficiency measures. The level of detail of the model is simulating the demand of single households with a time resolution of seconds. The model will take into account the randomness of human behavior by incorporating data about the variation of household sizes and lifestyles. Another important property is that the aggregated demand of the total population should have the measured average load characteristics, i.e. those of the standard load profile. An accurate representation of the household electricity demand requires simulating the use of individual appliances, and there are currently two main methods employed for this type of simulation. Firstly the activity based modelling approach involves using behavioral statistics and time use surveys to calculate the likelihood of an activity occurring

and therefore of a certain appliance being in use. The limitation of this technique is that certain activities are very unpredictable, and these tend to be modelled randomly which will not lead to an accurate aggregate result. The second method involves using aggregated data, namely the standard load profiles, and knowledge of which activities take up a certain percentage of total energy demand to generate appliance usage. The limitation of this technique is that it does not account for certain activities to be more common during certain times, leading to inaccuracy. The novel approach of this work is to combine these two methods, using activity based modelling for the more predictable loads, and then assigning the remainder using the standard load profile. This method will ensure that both the individual household loads are realistic, as well as the aggregated load for the total population. The model will be integrated with a spatial database which contains information of existing buildings in the metropolitan area of Munich, incorporating the distribution of household sizes in the various districts. This will allow realistic simulation of the household loads for the entire city. Once completed, the model can be used to evaluate various energy saving strategies and to test a wide range of policy and technology scenarios on building block or city quarter level.

Energy Valley Bavaria - Flexible Power Plants Dynamics in Steam Generation

Steffen Kahlert^{a*}, Julia Hentschel^a, Andreas Kohlhepp^a, Gerrit Schatte^a

^a Institute of Energy Systems, Department of Mechanical Engineering

*steffen.kahlert@tum.de

The integration of a rising share of renewable energy poses a challenge for the conventional generators and the transmission network in the power system. The fluctuating power production of the renewables leads to a lower capacity utilization and a more dynamic operation of the conventional power plants. To ensure a cost-efficient and stable supply system, changes in the conventional power plant technology and network infrastructure are essential. The “Munich School of Engineering launched the interdisciplinary project Flexible Power Plants which aims to bridge the gap between the power generation and the electrical network to provide innovative solutions for future power system. The common ground of most conventional power plants is the fact that they generate steam at high temperature and pressure by combusting a carbon-based fuel. The live steam is then expanded in a turbine to generate electrical power. The steam generation plays a key role in raising the efficiency and in power plant dynamics. High efficiencies demand high temperatures and pressures of the live steam. At the Institute for Energy Systems, the transient behavior of steam generators is to be investigated. First, dynamic process models of a combined cycle power plant and a coal fired steam power plant are developed to analyze the overall power plant behavior. Furthermore, experiments to obtain a more detailed insight into the heat transfer and the fluid properties in evaporators are going to be performed. The dynamic process simulation contains the process model, as well as the control system, and allows the prediction of the power plant performance during a more flexible operation. The steam generator contains thick-walled components, such as the steam header and the steam drum, which are highly sensitive to thermal stresses due to temperature changes. The goals are to increase the flexibility of the power plant and to minimize the negative effect of the load cycling on the

critical components. Different measures are analyzed using dynamic simulation. The start-up of power plants has to be accelerated to reduce fuel costs and CO₂ and NO_x emissions. To better address the need of controllability in power generation, optimized control strategies for steam generators are developed in order to increase the load flexibility. Providing more balancing power can add to the stability of the overall power system. The mentioned dynamic operation strongly interferes with the thermo-physical behavior of the evaporation process. Especially in the near critical region (temperatures of ± 50 K around the pseudocritical temperature) large changes in the thermo-physical properties lead to significant deviations between the calculated and the real behavior of the heat transfer. This can lead to unsafe conditions that may result in damage of the power plant’s evaporator. Thus, the suitability of the evaporators of existing power plants for dynamic loads as well as the potentials of optimization for future power plants have to be studied. To be able to archive both goals the experimental test facility HIPER (HIgh Pressure Evaporation Rig) is currently under construction at the Institute for Energy Systems. The basic layout of HIPER is a closed water loop that can feed an evaporation test section with variable conditions regarding mass flux density, pressure and enthalpy at the inlet of the evaporation tube. The evaporation tube itself can be subjected to variable heat flux densities and heat flux density distributions, the inclination of the tube can be adjusted. The boundary conditions can be changed dynamically. The main components of the test rig are a high pressure piston pump, a preheater, a backpressure throttle, the evaporation tube as well as a feed water tank and a cooling system. The Evaporation tube itself can be exchanged in a modular fashion to study different geometries (diameter, internal ribs or one-sided heating).

Scalable Economic Dispatch with Continuous Variables

Elisabeth Kellerer^{a*}, Florian Steinke^b

^a Energy Economy and Application Technology, Electrical Engineering and Information Technology

^b RTC AUC CAO, Corporate Technology, Siemens

*elisabeth.kellerer@tum.de

The ongoing changes in electricity systems present new challenges to economic dispatch algorithms. In the past, a few large power plants of one operator were scheduled cost optimally. Now, a conglomerate of owners operates small, decentralized renewable energy sources and combined heat and power plants (CHP). In the future, also flexible demands will be utilized in economic dispatch to compensate for renewable energy intermittencies. The strong rise of dispatchable units and their increasing complexity challenges current economic dispatch algorithms, such as mixed integer linear programming (MILP) [4]. This trend will require economic dispatch algorithms to scale well with the number of dispatchable units - scalability. Furthermore, it places restrictions on the communication effort per unit - communication limits. Competition in multi-owner environments is not conducive to share technical and cost characteristics freely - secure business secrets. The transition from a few, large power plants with long construction horizons to an environment with many small, frequently changing renewable or consumption units requires the ability to integrate additional units quickly and cheaply - plug and play. Besides, the integration of production entities throughout the distribution grid turns line capacities into considerable restrictions for the economic dispatch.

We present a novel decentralized, cost optimizing dispatch algorithm for radial distribution grids, which fulfills the new requirements while respecting the transport capacity limits [2]. The algorithm is inspired by probabilistic graphical model (GM) methods [1]. A GM is a formalism to describe dependence structures among random variables in statistical models by a graph. GM methods, e.g. believe propagation (BP), proved their performance in answering statistical queries on plenty of variables, such as image segmentation. To do so, BP exploits the dependence structure, in our case given by the grid topology, to split the global problem into small local problems. These local problems are coordinated by messages such that the local solution

on equals the global solution. The key idea behind the application of GM methods to economic dispatch is the energy conservation at each node; it splits the global energy conservation constraint into equivalent nodal balances based on transport equations. This enables us to use transport based cost functions, called messages as in BP, harmonize the small, local problems to solve the global problem. For radial distribution networks, a message passing order leading to a single run, global optimal result exists.

The proposed GM-approach satisfies the new requirements - scalability, communication limits, secure business secrets, plug and play - and ensures a with respect to transport capacities feasible, optimal dispatch result. For each additional unit the message passing order need to be adjusted, but the algorithmic structure is preserved. Messages reflect just the minimal cost of the transferred units and hinder thereby the reconstruction of the single unit characteristics. Furthermore, this minimalism reduces the communication effort. By the incoming messages, each unit is enabled to decentral evaluate how a feed-in change influence the global optimal dispatch value and feasibility. This enriches the unit with complete insights of their influence, in contrast to the infinitesimal central controller insight obtained by Lagrangian-multipliers, cf. [3].

[1] D. Koller, N. Friedman; Probabilistic graphical models: principles and techniques; The MIT Press, Cambridge 2009.

[2] A. E. Kellerer, F. Steinke; Scalable Economic Dispatch for Smart Distribution Grids; Submitted to IEEE Transactions on Power Systems, 2013.

[3] A. Y. S. Lam, B. Zhang, D. N. Tse; Distributed algorithms for optimal power flow problem. 51st IEEE Conference on Decision and Control (CDC), Hawaii, USA, December 10-13, 2012, 430-437.

[4] M. Carrión, J. Arroyo; A computationally efficient mixed-integer linear formulation for the thermal unit commitment problem; IEEE Transactions on Power Systems, 21(3), 2006, 1371-1378.

All-Inclusive Analysis as a Key Factor in CO₂-optimal Mobility

Maria Kugler^{a*}, Sebastian Osswald^a, Markus Lienkamp^a

^a Lehrstuhl für Fahrzeugtechnik, Fakultät für Maschinenwesen

*kugler@ftm.mw.tum.de

The average household in Germany produces about 15 tons of CO₂ emissions per year by direct actions. This amount is composed of different components. The emissions created by heating aggregate to approximately half of those total emissions. The amount of those emissions can be influenced mainly by changing the heating technology to a more non-polluting one like pellet furnace, solar system or using renewable electricity instead of the standard electricity mix. The usage of regenerative energy in the form of an integrated photovoltaic system (PV) additionally has the advantage that it can directly improve the emission output generated by the individual behavior in everyday routine. In consequence to nowadays high degree of household electrification all energy-saving methods of the respective single devices are tempered with the total number of energy consumers. Therefore the possibility to include zero-emission energy in the household balance is essential for reducing the CO₂ emissions. In an all-inclusive approach on inducing a better understanding and handling of CO₂ emissions, the individual mobility behavior as well as mobility demand in the direct familial environment needs also to be incorporated into the analysis, since it represents the last substantial influence on an overall CO₂ footprint. Here the concept of electromobility in combination with PV electricity shows large potential for overall CO₂-reduction. Methodology During the project 2car@GAP€ conducted within the eGAP Modellkommune Elektromobilität Garmisch-Partenkirchen and funded by the Bavarian State Ministry of Economics and Media, Energy and Technology a total num-

ber of 52 participants out of 20 households are provided with smartphones for mobility tracking purposes. This raw-data material of GPS-positions is analyzed in a three-stage approach in order to determine the real mobility behavior. First of all the unclassified data has to be separated in logical matching segments, which qualify for one single trip with one mode of transport (MOT). These segmentations can be caused by a certain significant time gap between two tracks or by an allegedly walking segment, which gives the possibility to switch between MOT. The next step comprises the actual detection of the most feasible MOT for each segment. For this purpose a multilevel logical elimination process based on characteristic values deduced from the driving pattern was implemented. The resulting MOT propositions for each segment are passed to the last step in the analysis, where the MOT succession of immediately consecutive segments is subjected to a plausibility check. This methodology results in a comprehensive view of the distinct MOT-usage in everyday mobility behavior and provides a basis for a detailed value-added CO₂-understanding. Due to the all-inclusive approach smart metering devices are installed at every household logging the balances of the general household, the supply by the PV as well as an existing charging station for electric vehicles (EV) provided for the project duration. By analyzing these data and superposing them with the mobility behavior it is possible to deduce not only the best moments for charging the EV but also possibilities to structure the total mobility according to the PV electricity supply.

Spin dynamics in organic solar cells measured by pulsed electrically detected magnetic resonance

Alexander J. Kupijai^{a*}, Konstantin M. Behringer^a, Martin Stutzmann^a, Martin Brandt^a

^a E25, WSI and Physics Department

*alexander.kupijai@wsi.tum.de

Organic photovoltaics (OPV) are of great interest for the development of sustainable energy sources as they promise very low production costs. Further improvements of the efficiency of organic photovoltaics are expected e.g. from advances in chemistry and the optimization of charge carrier transport. The latter could be achieved with the help of the intrinsic spins of the charge carriers which have a decisive influence on the charge carrier dynamics, as for example observed in organic magnetoresistance (OMAR). In order to understand the effect of magnetic fields in detail and to investigate the recombination and transport processes in organic solar cells we use the technique of pulsed electrically detected magnetic resonance (EDMR) where we measure the change of the photocurrent caused by resonant X-band microwave pulses in the presence of an external magnetic field. As test devices for this technique, which

has already proven to be a highly valuable tool in the investigation of inorganic photovoltaics, we use bulk heterojunction P3HT/PCBM (poly(3-hexylthiophene-2,5-diyl) / [6,6]-phenyl C61 butyric acid methyl ester) solar cells. At temperatures of 10 K we are able to observe both positively and negatively charged polarons in the pulsed EDMR spectrum and can identify them as partners in a spin-dependent pair process by experiments using two microwave frequencies. Using the time resolution and sensitivity of pulsed EDMR we are able to quantify the spin dynamics of the system and measure the lifetime of parallel spin pairs, the lifetime of antiparallel spin pairs, the spin decoherence time and the coupling strength between the spin partners. All of these microscopic parameters provide valuable information for an optimization of overall solar cell efficiencies.

Recovery of waste heat by means of Organic Rankine Cycle (ORC) for power generation

Wei Liu^{a*}, Dominik Meinel^a, Christoph Wieland^a, Hartmuth Spliethoff^a

^a Institute for Energy Systems, Department of Mechanical Engineering

*wei.liu@tum.de

The utilization of waste heat produced in a number of industrial sectors, e.g. steel or cement production or Internal Combustion Engine (ICE), is very promising for saving energy consumption. According to the report released by the U.S. department of energy, a significant percentage (20-50%) of total energy input is wasted into the coolant or the ambience for the technical infeasibility [1]. One of the main utilization difficulties is the low temperature (200°C - 400°C) of the waste heat source. A number of ways to recover low temperature waste heat have been so far proposed, and among them the Organic Rankine Cycle (ORC) technology featured with the use of organic fluid instead of water is considered as one of the most promising means for power generation. This work presents a study of ORC used for waste heat recovery from the exhaust gas of an ICE featured with i) constant and ii) variable temperature and mass flow rate, respectively. The waste heat gas is indirectly coupled to the ORC system by means of a closed loop with an intermediate heating medium (pressurized water in this study). Twelve working fluids are presented as candidates for cycle simulation. Moreover, this work introduces a novel term, i.e. the

Optimal Heat Source Temperature (OHST) which is based on the minimization of exergy destruction in the heat exchanger for optimization of system efficiency. For case i with a constant gas temperature and mass flow rate, all of the investigated working fluids are simulated with different evaporating pressures, and as a result, the optimal fluids are selected according to their system efficiencies. For case ii with a variable gas temperature and mass flow rate, higher thermodynamic performance can be achieved by adapting the evaporating temperature to the variable gas temperature. The OHST method is used for selection of the optimal evaporating pressure depending on the pinch position in the heat exchanger. Compared with the selection method presented in [2], the use of OHST can lead to a 50% increase in system efficiency.

[1] U.S. Department of Energy. Waste Heat Recovery: Technology and Opportunities in U.S. Industry, 2008.

[2] Quoilin S, Aumann R, Grill A, Schuster A, Lemort V, Spliethoff H. Dynamic modeling and optimal control strategy of waste heat recovery Organic Rankine Cycles, Applied Energy 2011;88(6): 2183-2190

Influence of Solvent Additives on performance of Organic Photovoltaics

Juan Felipe Martínez Grisales^{a*}, Eva Maria Herzig^b, Peter Müller-Buschbaum^a

^a Lehrstuhl für funktionelle Materialien, Physik-Department

^b Herzig Group, Munich School of Engineering

*felipe.martinez@ph.tum.de

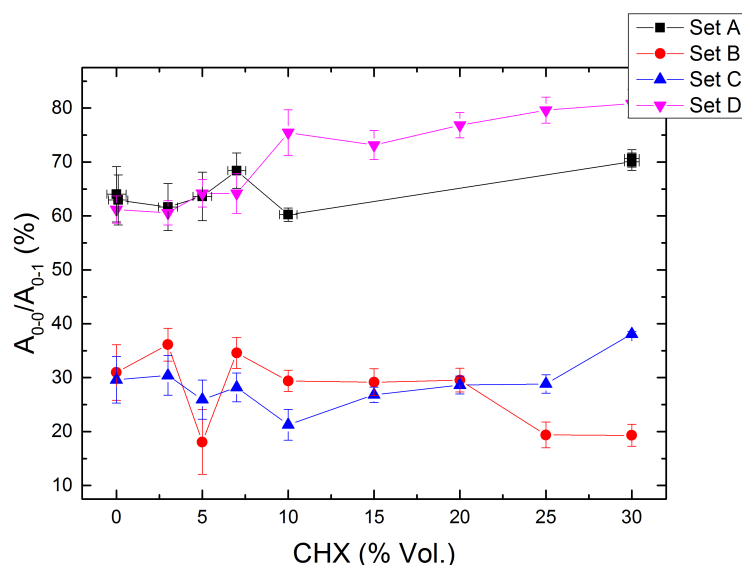

Organic Photovoltaics have been a very active research field since the discovery of conductive polymers. The interest in this field is due to the potential inexpensive and broad source of electrical energy in the future [1], however optimization in the architecture of the components is essential for the competitiveness of Organic Solar Cells against more traditional technologies and their inorganic counterparts [2]. Here we report on the influence of adding a medium boiling point solvent that is a bad solvent for one of the components to a standard photovoltaic on the bulk heterojunction architecture. We systematically study the influence of the additive on the photovoltaic system as well as the influence of ambient conditions such as temperature of substrate and solution. The analysis is carried out using different methods such as UV-Vis, Photoluminescence among others to obtain information on the morphology of the active layer, and to study the influence on the efficiency of organic photovoltaic devices. Four different sets of the active layer were prepared with different content amounts of the bad solvent under different parameters (solution temperature, substrate temperature, concentration of solution set A to D). From the UV-Vis data

the ratio between the first vibronic states were calculated, which is related to the conjugation length of the polymer [3], and therefore is an indicator of alignment of the conjugated orbitals of the polymer and hence also of the mobility of holes through the polymer. It is visible from Fig. (1) that not only the amount of the bad solvent heavily influences the conjugation length of the polymer, but also the ambient conditions of the samples. Moreover, it is possible to restrain local alignment of the conjugated orbitals not only by restricting the formation of aggregates in solution but also by the temperature of the substrate. This shows that the local ordering of the polymer is very delicate and easily influenced by the external parameters already during the preparation of the film.

[1] Matthias A. Ruderer, Peter Müller-Buschbaum *Soft Matter*, 2011,7, 5482-5493

[2] M.C. Scharber, N.S. Sariciftci, Efficiency of bulk-heterojunction organic solar cells, *Prog. Polym. Sci.*, 2013, 38, 1929-1940

[3] J. Clark, J. Chang, F. Spano et al. *Appl. Phys. Lett.*, 2009, 16, 163306

Aqueous processed titania nanoparticle based hybrid solar cells

Christoph Mayr^{a*}, Volker Körstgens^a, Hristo Iglev^b, Peter Müller-Buschbaum^a

^a Lehrstuhl für Funktionelle Materialien, Physik-Department

^b Lehrstuhl für Laser- und Röntgenphysik, Physik-Department

*christoph.mayr@ph.tum.de

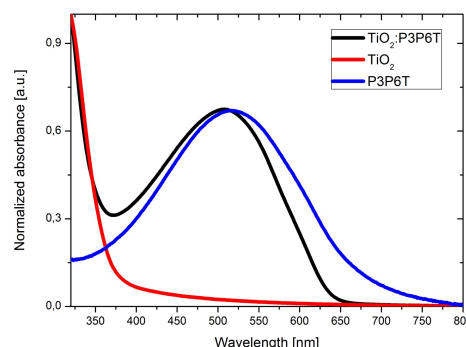
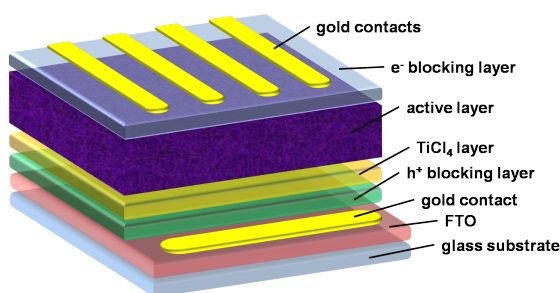

Hybrid solar cells combine the advantages of both materials they are made of. A conjugated polymer is typically used as electron donor and hole conductor with its high light absorbance and the possibility of a cheap and low-energy production, e.g. by roll-to-roll processing [1]. An inorganic electron acceptor and transporter is added as the second part of a hybrid active layer. Today, in the production of hybrid solar cells there is often the need for toxic organic solvents, which contradicts the idea of green energy. Therefore, a potential way, which is more environmentally friendly, is using aqueous-processed active layers. G. Wei et al. presented in their work fill factors and efficiencies for aqueous processed solar cells up to 80 % and 2.14 %, respectively [2]. For the electron donor and acceptor we use a water soluble poly(3-hexylthiophen-2,5-diyl) (P3HT) analogue and titania nanoparticles, respectively. The advantage of these particles is their size tune ability, their high absorption coefficient and the high surface area. Thalluri et al. reached an efficiency of 0.70 % for a similar system [3]. With the use of nanoparticles, a large interfacial area with the polymer is facilitated. This bulk junction is desirable, because the movement of the electrically neutral excitons, which are

generated during the light absorption, cannot be controlled. Therefore, a donor-acceptor interface is needed within the exciton diffusion length to successfully separate the charges and use the power of the absorbed photon. Different ways of applying the active layer were investigated, namely spin coating and spray coating. Our spraying procedure allows a good control over film thickness and over the polymer:titania-ratio. Therefore, the effect of these parameters, as well as different electron blocking layers are measured under AM 1.5 conditions. Furthermore we investigated the morphology of the active layer and its interfaces with the blocking layers in situ during the spray process. The active layers are studied with UV-vis-spectroscopy to obtain more information about the optical properties.

[1] B. R. Saunders, *Journal of Colloid and Interface Science* 369 (2012) 1-15

[2] Wei, Hao Zhang, Haizhu Sun, Bai Yang, *Nano Today* 7 (2012) 316 - 326

[3] G.K.V.V. Thalluri, J. Bolsée, A. Gadisa, M. Parchine, T. Boonen, J. D-Haen, A.E. Boyukbayram, J. Vandenberg, T.J. Cleij, L. Lutsen, D. Vandezande, J. Manca, *Solar Energy Materials and Solar Cells* 95 (2011) 3262 - 3268.

Performance of P3HT:PCBM solar cells modified with iron oxide nanoparticles

Daniel Mosegui González^{a*}, Gonzalo Santoro^b, Stephan Roth^b, Peter Müller-Buschbaum^a

^a Lehrstuhl für funktionelle Materialien, Physik Department

^b Deutsches Elektronensynchrotron DESY

*daniel.mosegui@ph.tum.de

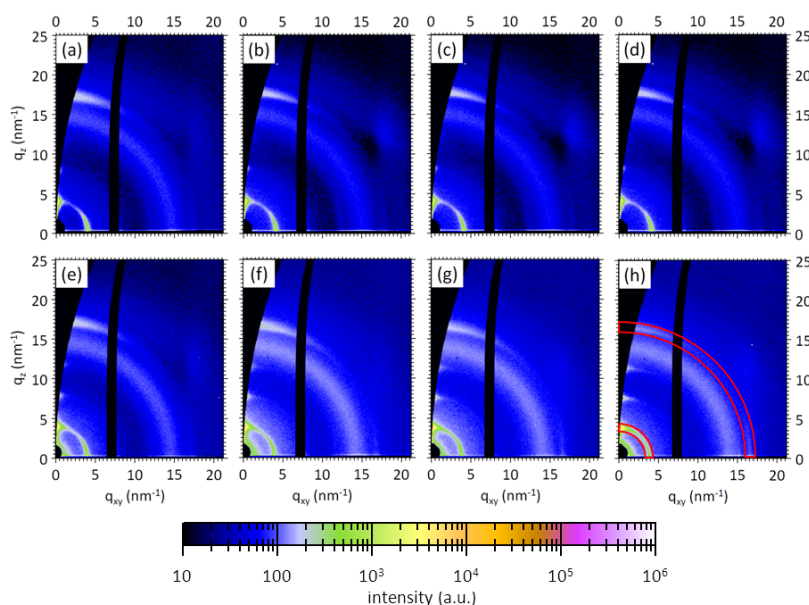

Among the different systems studied in organic solar cells, the combination of P3HT:PCBM has received the highest attention. Recently, the performance of such devices under magnetic stress has been investigated. In the case of organic electronic devices, the addition of magnetic fields can be achieved via the incorporation of iron oxide nanoparticles, which has been reported as a factor influencing the device performance. Magnetic fields, amongst other effects, alter the position of the molecular energy levels, allowing 'a priori' forbid-

den spin transitions. Moreover, the presence of heavy metals increases the L-S coupling in the system, increasing the rate of intersystem crossing. The aim of the present investigation is to characterize through which channels the presence of iron oxide nanoparticles affects the performance of P3HT:PCBM based solar cells. The morphology evolution is tracked with scattering techniques. Spectral behavior and electrical response of devices are also investigated.

Numerical simulation of cavitation phenomena in Diesel injection systems

Felix M Örley^{a*}, Michael S Mihatsch^a, Bruno Beban^a, Christian P Egerer^a, Steffen J Schmidt^a, Stefan Hickel^a, Nikolaus A Adams^a

^a Institute of Aerodynamics and Fluid Mechanics, Department for Mechanical Engineering
*felix.oerley@aer.mw.tum.de

Highly purified liquids can hold even strong tension (i.e. negative pressure) under laboratory conditions. In practice, evaporation takes place once the static pressure of the liquid drops below vapor pressure. This phenomenon is called cavitation. In the case of hydrodynamic cavitation, this pressure-drop is usually induced by a local acceleration of the flow. The collapse-like recondensation of vapor structures can lead to noise, vibration or erosion of the surrounding structure. Modern Diesel injectors operate under high rail pressures of 2000 to 3000 bar. Cavitation phenomena therefore are unavoidable in these systems and must be understood and controlled. Cavitation induced erosion can influence the proper function of the injector, or may even cause a failure of the system. On the other hand, cavitation may be used as a design tool, e.g. to promote spray breakup or to choke a nozzle to maintain a certain flow rate. Since one strategy of car manufacturers to meet recent changes in legislation concerning engine emission limits (EURO5) is to further increase the system pressure to achieve a more efficient combustion, cavitation phenomena become even more significant. Typically, characteristic dimensions of fuel channels inside diesel injectors lie in the range of tens to several hundred microns. This makes the instrumentation of an injection nozzle with diagnostic equipment, such as optical measurement methods or pressure sensors, for an experimental flow characterization very limited. In addition, the high operational pressures state another limiting factor. Short intrinsic timescales im-

posed by inherent flow dynamics, by functional components such as open or closing of the control valve or injector needle, or by multiple injections per engine cycle, make time-accurate measurements challenging. Therefore, experimental analysis assessing cavitation erosion can usually supply information about incubation time, position, and the progress of erosion damage, but does not necessarily reveal the underlying flow mechanism, which would be desirable for identification of possible countermeasures and optimization. Computational Fluid Dynamics (CFD), on the other hand, may be used to investigate the small-scale geometries and flow structures in a time-accurate manner. Numerical simulations thus have the potential to become an important tool in the design process. Our contribution to the 4th MSE colloquium gives an overview over the research activities at the Institute of Aerodynamics and Fluid mechanics in the field of numerical simulations of cavitating liquid flows in the context of injection systems. We put a focus on the simulation of complex geometries and numerical predictability of cavitation induced erosion risk. Additionally, Large-eddy simulations (LES) are performed to assess the interaction of turbulence and cavitation in canonical flows, and to investigate the flow field of a cavitating orifice with spray formation. Aiming at the simulation of realistic full-system configurations, we introduce moving boundaries to include a dynamic needle movement during the opening and closing process of the injection cycle.

Polymeric electrode for all-printed organic electronics: Following film formation and crystallization in-situ

Claudia Maria Palumbiny^{a*}, Feng Liu^b, Alexander Hexemer^c, Thomas Russel^b, Cheng Wang^c, Peter Müller-Buschbaum^a

^a Lehrstuhl für funktionelle Materialien, Physik Department

^b Department of Polymer Science and Engineering, University of Massachusetts Amherst

^c Advanced Light Source, Lawrence Berkeley National Laboratory

*claudia.palumbiny@ph.tum.de

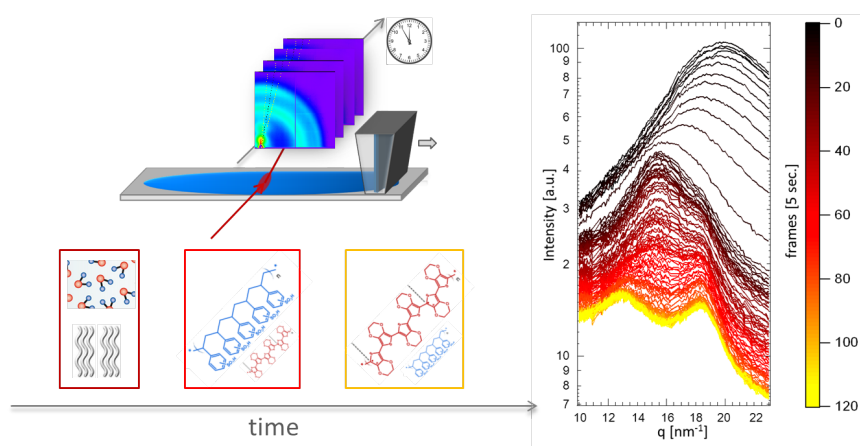

The semi-transparency and potential to up-scale devices to large areas, makes organic electronics (OE) and organic photovoltaic devices (OPV) highly interesting for implementation e.g. into buildings. Further their adaptability due to their flexibility and light weight open up additional applications such as portable modules. One of the main advantages for all applications is the potential of easy up-scaling by printing technologies such as roll to roll (R2R) with slot die coating. However, most investigations of morphology, crystallinity and electronic properties of thin films for OPV are based on lab-scale techniques as spin coating. The growth of thin films, however, crucially depends on the conditions during film deposition and film treatment. To follow the film formation in-situ, we use a self-made slot die coater, specially designed for the implementation at a synchrotron facility (beamline 7.3.3. at the Advanced Light Source (ALS) of the Lawrence Berkeley National Laboratory (LBL) in Berkeley in cooperation with University of Massachusetts Amherst). This enables in-situ grazing incidence wide angle X-ray scattering (in-situ GIWAXS) measurements [1] during the slot die coating process. With the high flux of the synchrotron beam and a low background due to a helium atmosphere, a good time resolution for the in-situ study of the film formation kinematics is realized. It allows us to follow the changes in molecular orientation and crystallinity. We show in-situ printing and GIWAXS measurements of the co-solvent modified poly(3,4-

ethylenedioxythiophene):poly(styrene-sulfonate) (PEDOT:PSS), a printable polymer blend alternative to transparent conductive oxide electrodes (TCOs). Going towards all printable electronics, there are still challenges for roll-to-roll processed flexible devices. Typically, oxide materials such as indium tin oxide (ITO) are used as TCO in the fabrication process for organic solar cells or light emitting diodes. ITO however has several drawbacks which become obvious if aiming for up-scaling of OEs. The high cost of ITO and the limited existence of indium are limiting factors, but also the brittleness of ITO under bending [2] plays a crucial role. Thinking of flexible devices, this is one of the main advantages of OPV devices over conventional PV. Several attempts have been made to substitute ITO as an electrode. In this context, the polymer blend PEDOT:PSS has attracted high attention. This is mainly due to its advantageous properties such as transparency, easy processability, as dispersed in water and stability upon bending. Further, PEDOT:PSS is already implemented in organic electronic devices. To use PEDOT:PSS directly as an electrode, however, it is still lacking in conductivity. Blending with high boiling point co-solvents is known to increase the conductivity of PEDOT:PSS from 10 S/cm by three orders of magnitude [3,4]. This makes it comparable to the conductivity of ITO and can thereby replace ITO as a stand-alone electrode. Using the slot die coating deposition method and combining it with GIWAXS measurements, we are able to follow

the film evolution during drying for highly conductive PEDOT:PSS. The results are further correlated to the conductivity of the thin films. Together, these results can be directly used for directed modification of PEDOT:PSS films for optimized properties and for R2R processing for practical devices.

[1] P. Müller-Buschbaum, *Advanced Materials* 2014, DOI: 10.1002/adma.201304187.

[2] S. I. Na, S. S. Kim, J. Jo, D. Y. Kim, *Advanced Materials*, 20 (21), 2008, pp. 4061-4067.

[3] Y. H. Kim, C. Sachse, M. L. Machala, C. May, S. V. Müller-Meskamp, L. Leo, *Advanced Functional Materials*, 21 (6), 2011, pp. 1076-1081.

[4] C. M. Palumbiny, C. Heller, C. J. Schaffer, V. Körstgens, G. Santoro, S. V. Roth, P. Müller-Buschbaum, under peer review.

X-ray and neutron scattering study on self-organised anodic TiO₂ nanorods for battery applications

Neelima Paul^{a*}, Jassen Brumbarov^b, Amitesh Paul^c, Ying Chen^b, Jean-Francois Moulin^d, Peter Müller-Buschbaum^e, Julia Kunze-Liebhäuser^b, Ralph Gilles^a

^a Heinz Maier-Leibnitz Zentrum (MLZ)

^b Physikdepartment E19

^c Physikdepartment E21

^d GKSS-Forschungszentrum Geesthacht GmbH

^e Physikdepartment E13

*neelima.paul@frm2.tum.de

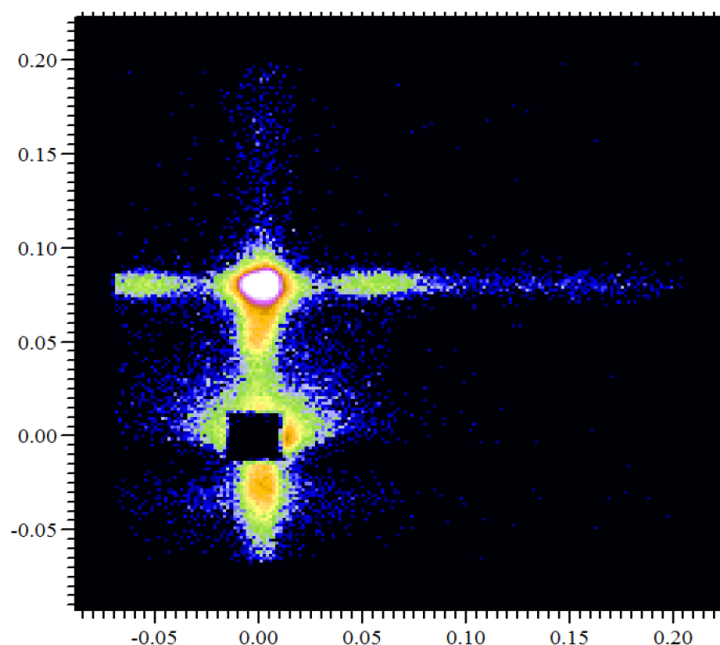

We present a detailed comparison on the surface and bulk morphology of self-organised conductive titania nanotubes, in their bare state as well as with a Si coating, using a combination of three complementary scattering techniques. Grazing incidence small angle X-ray scattering (GISAXS) show the distinct signatures of a prominent lateral in-plane correlation of the nanotubes of 100 nm and a tube radius of 50 nm. After Si coating on the tube walls, the tube radius is reduced. Using X-ray reflectivity (XRR), we determine the thickness of the Si coating on the TiO₂ pore walls. The structure of these two types of bare and Si coated TiO₂ tubes is additionally investigated with time-of-flight grazing incidence small-angle neutron scattering (TOF-GISANS) for depth dependent analysis. The ba-

re titania nanotubes show a well defined pore structure which are 50 nm in radius and separated by 100 nm. On Si coating, the radius reduces from 50 nm to 35 nm and consequently the porosity also reduces. Additionally, we find, the Si coating preserves to a large extent the prominent lateral structure without forming any solid overlying layer. This is consistent with the GISAXS data. Such in-depth structural investigations over large sample areas are useful towards efficient development of batteries because Si based electrodes are most promising anode materials for next generation Li⁺-ion batteries. Figure: A 2D TOF-GISANS image showing first order and second order side maxima corresponding to the well defined lateral structure of the titania nanotubes.

In-situ characterization of Lithium Ion battery during cycling for performance optimization

Aneil Pokarel^{a*}, Irmgard Buchberger^a

^a Institute of Technical Electrochemistry, Department of Chemistry

*aneil.pokharel@gmail.com

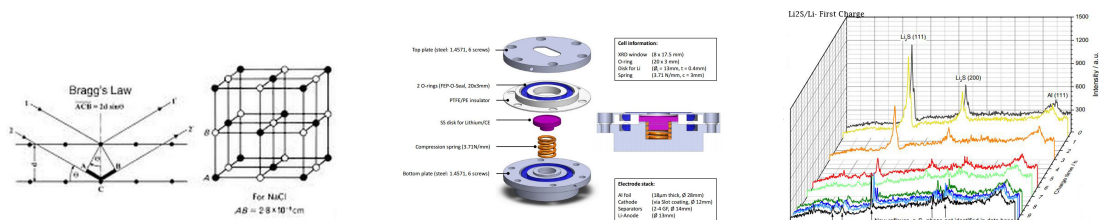

In the era of high demand for sustainable energy systems, an efficient and effective battery system is bound to play a role. Automotive companies like Tesla motors, BMW, Toyota among others have been leading the markets to enable sustainable electric mobility. While corporate motive for developing sustainable energy sources is laudable, battery science as we understand is still a bottleneck to progress. One approach that can be taken to tackle this huge problem is to dive deeply into understanding the inner workings of the battery as it is operating. The focus of our project is to do just that. A capability to accurately monitor and assess real time evolution of the battery cell as it is subject to charging and discharging provides an instrumental insight to a scientist studying the capacity and stability of the battery cell. In achieving this vision, there are several methods that could be employed. In this project we are using in-situ cell that was designed in-house. In-situ XRD cell needs to be small and portable, free from leakage, easy to characterize and the materials making the cell and the electrode needs to be stable against the electrolyte and the cell voltage. In order to get best x-ray data possible, XRD beam in our operation uses high intensity Molybdenum radiation as a source. As the incident beam of x-ray photons come into contact with the regular periodicity of the electrode material, it is diffracted. The manner in which these beams are diffracted can be exploited to infer a dynamic behavior of the crystal systems of the material that is diffracting the x-ray photon beam. The X-ray diffraction condition is determined by what is known as the Bragg's law. Bragg's condition for diffraction can be written as $2d \sin \theta = n\lambda$, where (d) is this periodic spacing between what is called the crystal lattice planes, (λ) is the wavelength of the incident x-ray radiation and (n) is an integer which signifies an order. The diffraction pattern formed by the powder

sample is a plot of photons intensity that was diffracted from the lattice planes of the crystalline surface versus the angle between the incident beam and diffracted beams. We use this data and a crystallographic database to understand what we are observing. As part of system optimization efforts, this project will seek improvements in engineering and designs of the XRD cell. Its performance will be benchmarked against another type of stable cell known as the t-cell. XRD cell needs to be designed with great precision in order to ensure that it is representative of a standard battery cell, additionally it needs to be designed in such a way that the battery (charging/discharging) process can be characterized while its happening. This ability to properly characterize the battery process will help us make battery cells that are cheaper, lasts longer (gravimetric capacity), fast charging rates and are more powerful (specific power density). Some of the major pertinent issues that will be addressed in the short term are issues with air gaps, the bending of the aluminum electrode and degradation of important x-ray data. Once the engineering issues are sorted out, the larger scope and vision of this project is to develop and refine methods for in-situ XRD cell in order to parameterize changes in the lattice parameters as a function of state of charge and discharge (SOC/SOD) which will help in determining phase stability and appearance and disappearance of new phases during cycling. Additionally, this project will focus on assessing and optimizing the performance of various electrode and/or electrolyte systems, cell geometries for capacitive degradation in various C-rates environment while also gaining deep crystallographic information on the systems as it undergoes cycling. Initially, this level of optimization will happen for in-situ XRD cell and swagelock T-cell along with LFP and NMC active cathode material.

Printing Active Layers for Application in Organic Solar Cells

Stephan Pröller^{a*}, Feng Liu^b, Chenhui Zhu^c, Peter Müller-Buschbaum^d, Thomas P. Russell^b, Alexander Hexemer^c, Eva M. Herzig^a

^a Herzig Group, Munich School of Engineering

^b Department of Polymer Science and Engineering, University of Massachusetts Amherst

^c Advanced Light Source, Lawrence Berkeley National Lab

^d Chair for Functional Materials, Physics Department

*stephan.proeller@ph.tum.de

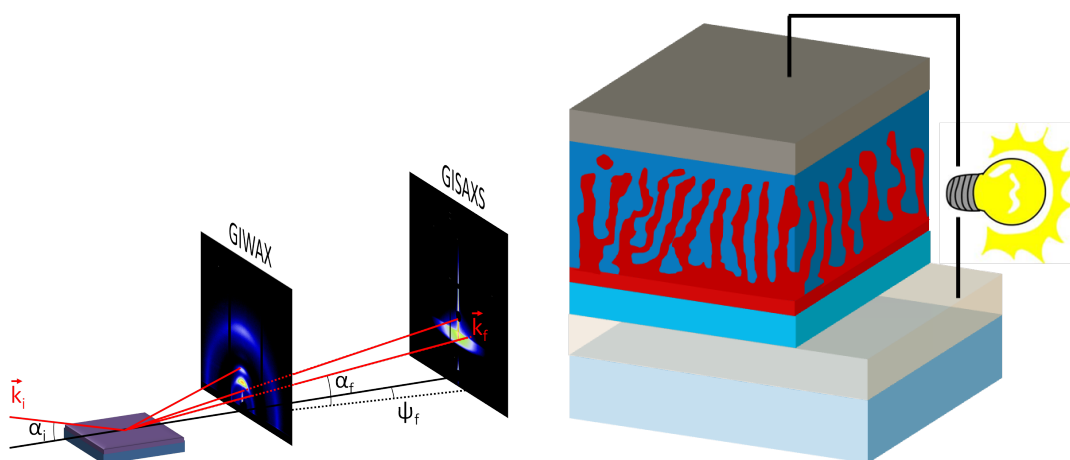

High expectations within the area of renewable energies are set on photovoltaics. Currently, solar cells are based on inorganic semiconductors, most of them made of silicon. A disadvantage of the silicon photovoltaic technology is the use of expensive materials and energy demanding production processes, which can be overcome by using organic materials. These organic materials have the advantage of high absorption and the possibility to fabricate flexible and lightweight solar cells. [1] Therefore, organic solar cells are eminently suited for applications such as mobile devices, the integration into flexible carriers like clothes or sunshades and, due to the possible transparency in the visible light, for applications on windows. Furthermore, the production out of a liquid phase of the polymer in solution offers the opportunity to produce the devices with printing methods such as roll-to-roll production techniques, inkjet-printing or slot-die coating. [2] These production techniques offer the possibility to potentially produce organic solar cells on large scale at low cost. In order to efficiently work, the inner structure of the organic solar cells is of extreme importance. [3] The bound charge carriers produced in the active layer upon illumination have to travel to an interface of the so-called donor and acceptor material via diffusion. The diffusion length is limited to around 10 nm, which also sets the scale of interest for morphology investigations. Tech-

niques providing information in that regime are based on X-ray scattering among which the grazing incidence geometry provides good information about large areas of thin films. [4] In collaboration with scientists from the Advanced Light Source at the Lawrence Berkeley National Lab in California, we were able to carry out in-situ measurements on printed organic photovoltaic films. The results of these X-ray scattering experiments show the evolution of crystal structure of the active layer films. In combination with absorption measurements in the visible and ultraviolet regime as well as the testing of solar cells, the function-morphology relationships are investigated. Furthermore the motivation and challenges of such an experimental set-up are highlighted. These results contribute to the basic understanding of the printing process of conducting thin films and are of intrinsic importance for the upscaling of organic solar cell production.

[1] Fraunhofer-Institut für Solare Energiesysteme ISE, press information 17/10 of June, 17th 2010

[2] R. R. Søndergaard et al., Journal of Polymer Science, 51 (2012), 16-34

[3] G. J. Hedley et al., Nature Communications, 4 (2013), 1-10

[4] P. Müller-Buschbaum, Advanced Materials (2014), 1-18

Block copolymer based membrane for lithium ion micro batteries

Majid Rasool^{a*}, Ezzeldin Metwalli^a, Hans Beyer^b, Anna Eberle^b, Hubert A. Gasteiger^b, Peter Müller-Buschbaum^a

^a Chair for Functional Materials, Physics Department

^b Chair for Technical Electrochemistry, Department of Chemistry

*majid.rasool@ph.tum.de

In the light of an increasing demand on power sources for microdevices, the micro-scaled lithium based membranes paves the way for new opportunities regarding design and application. The morphology of lithium ion-polymer hybrid films [1] based on P(S-b-EO) block copolymer (BC) electrolyte is investigated using small angle x-ray scattering (SAXS). Additionally, lithium containing BC films are sandwiched between two metal electrodes and the film conductivity at different temperatures and salt concentrations is measured using impedance spectroscopy. The current block copolymer electrolyte consists of both conductive lithium containing

PEO domains as well as mechanically stable glassy polystyrene domains. Lithium ion incorporation is found to inhibit the crystallization of PEO block. A progressive Ionic conductivity enhancement is observed with increasing salt concentration. The correlation between the morphology and ionic conductivity of the current lithium ion-polymer hybrid BC films is employed to put an insight into the mechanisms responsible for the conduction of lithium ions in these systems.

[1] E. Metwalli, et al., *Macromol. Chem. Phys.* 212, 1742 (2011).

On Reducing the Communication Requirements for EV Charging with Vehicle-Originating-Signals

Jose Victor del Razo Sarmina^{a*}, Christoph Goebel^a, Hans-Arno Jacobsen^a

^a I-13 Middleware and Applications, Computer Science

* victor.del-razo-sarmina@tum.de

To keep the electric grid stable, power supply and demand have to be balanced at all times. To date, this balance is preserved by dispatching generators to match a given demand. As the share of energy from renewable sources like wind and solar continues to increase, demand-side management and energy storage are becoming more important. Controlling flexible loads, in particular, could help to achieve the ambitious renewable integration targets set by different countries.

The Vehicle-Originating-Signals (VOS) approach enables an aggregator to control how a fleet of electric vehicles (EV) charges in order to follow an arbitrary power profile. This approach, however, relies on bi-directional communication between EVs and the aggregator on every time step. Although lower than a per-iteration message exchange that some distributed optimization mechanisms require, it still represents an additional load in the communications network. This load increase becomes more significant as the number of EVs and the granularity of the control intervals (i.e., shorter time steps) continue to grow.

This work presents a method to further reduce the communication requirements of the VOS approach by minimizing the number of messages exchanged between the EVs and the aggregator. We also evaluate the method's performance with respect to the original VOS approach and discuss its trade-offs and challenges.

Our contribution can be summarized as follows: i. a method to reduce the frequency of messages sent by EVs by incorporating the combination of future values

on a single message, ii. a method to reduce the number of messages sent by the aggregator by introducing a single broadcast set point message as opposed to dedicated messages to each EV, iii. an analysis of challenges and requirements together with a solution proposal for combining the two methods above, and iv. a quantified analysis of the trade-off between reduction in number of messages, increase in message size, additional retransmission requirements and performance.

The VOS approach can be generalized to different loads and objectives. For the evaluation, we use a load leveling scenario based on electricity demand, solar generation, and car mobility data from Munich, Germany.

Our results show that it is possible to significantly reduce the number of messages with a marginal impact on the algorithm's performance. The number of messages sent by the EVs can be reduced in frequency by grouping combination of future values within a single message. The message size, however, increases accordingly. The number of messages sent by the aggregator to EVs can be reduced to a single broadcast message per time step. The counter effect is a moderate increase in uncertainty. In addition, it is possible to combine both methods. This requires the implementation of a retransmission protocol with a marginal increase on the total number of messages with respect to the savings potential of the single methods. These improvements contribute towards more network-friendly solutions for smart EV charging.

Will Electric Vehicles Overload the Grid? A solution using Charging Control based on Dynamic Budgets

Jose Rivera^{a*}, Christoph Goebel^a, Hans-Arno Jacobsen^a

^a Application and Middleware Systems, Department of Informatics
*j.rivera@tum.de

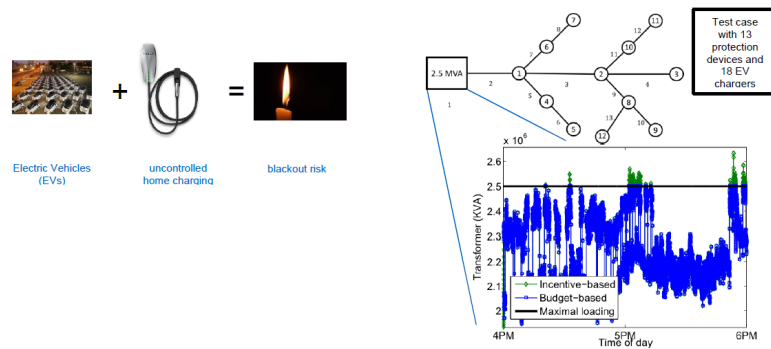

The current power distribution infrastructure cannot handle the significant load increase caused by the introduction of large EV fleets: A typical household consumes an average 2 kW, while home EV chargers that can charge with up to 22 kW can already be purchased. Since a 630 kVA transformer serving 250 households can handle an average load of up to 2 kW per house, we can see that the integration of EVs would exceed the capacity of the grid. One solution to this problem is to upgrade the distribution grid in order to handle the load increase. This, however, comes at a huge cost and would slow down EV adoption. A more practicable solution is to use Information and Communication Technologies (ICT) to control EV charging. The challenge in this approach is the large number of expected EVs and their unknown spatial distribution. Furthermore, the distribution grid's state is highly dynamic and, if renewable energy is present, difficult to predict. Thus, there is growing interest in developing a distributed system for the control of EV charging, that can adapt quickly to the fast dynamics of the grid, allows for local decisions of the individual devices and optimizes the global operation of the whole system. We propose a novel distributed algorithm for real-time EV charging control considering grid constraints. We formulate the problem like a Network Utility Maximization (NUM) problem. The goal herein is to maximize the utility of the EV chargers considering their individual constraints and the constraints of the grid for a particular state of the distribution system. The standard approach for solving NUM problems relies on using dual decomposition and subgradients methods, which through a dual price exchange mechanism yields algorithms that operate on the basis

of local information. The drawback of the dual decomposition approach is that its iteration results are only feasible at optimality, i.e., the control values can only be used on convergence. In real-time EV charging control, a grid overload can only be avoided if we are able to react within milliseconds, to avoid the triggering of protection devices. Thus, EV charging is a time critical application, where the iterative process of the optimization algorithm may need to be stopped before optimality is reached. Furthermore, the produced results should be feasible on each iteration (anytime property). Anytime algorithms are algorithms that return a feasible solution for any allocation of computation time, and are expected to return better answers when given more time. Our approach to solving this problem is based on the notion of dynamic budgets defined by the protection devices and allocated to each EV charger. Given the system's current state, we solve EV charging as a NUM problem in a distributed manner and obtain closed form expressions for computations performed by EV chargers and protection devices. In this work, we analyze the convergence of this approach for synchronous and asynchronous execution. Beyond this, we evaluate our approach using real data and show its advantages against the standard dual decomposition approach: Our proposed algorithm converges faster to the optimal result and is more robust with regard to parameterization. Furthermore, it is capable of yielding feasible, albeit suboptimal, control values anytime. Given the system's current state, the different devices perform computations using only their local information and exchange messages to reach the optimal operation point for the whole system.

Novel thermoelectric films based on polymer-nanoparticle composite

Nitin Saxena^{a*}, Peter Müller-Buschbaum^a

^a Institut für Funktionelle Materialien, Physik Department

*nitin.saxena@ph.tum.de

$$ZT = \frac{\sigma S^2}{\kappa}$$

Thermoelectric materials have gained increased attention by the scientific community over the past years, due to a high interest in renewable, sustainable and environment-friendly technologies for energy generation. A significant part of the solar spectrum reaches the surface of the earth in the form of infrared light, which does not allow for energy generation using solar cells to a large extent. Thermoelectric devices can be promising for applications such as waste heat recovery in heat engines or possibly coatings for house walls or windows. In a thermoelectric material, a temperature difference is applied to both ends. This leads to a change in the distribution of charge carriers through a flux from the hot to the cold side, depending on the electrical conductivity of the material. In order to maintain the resulting voltage, it is necessary to have a sufficiently low thermal conductivity, which in turn prevents the propagation of phonons and heat and thus the thermal equilibration of the material. A measure for the usability of a thermoelectric material is the so-called figure of merit ZT, seen in the equation given below. Sigma describes the electrical conductivity, S represents the

Seebeck coefficient or thermopower of the material and Kappa the thermal conductivity. Sigma*S² is also often referred to as the power factor in literature. So far, thermoelectric materials mostly comprised inorganic components, such as bismuth and tellurium. Although these materials show high figures of merit, they suffer from high production costs, laborious procedures for reducing the thermal conductivity through nanostructuring, and environmental concerns because of potential toxicity of the components and/or low abundance. These factors have inhibited a large scale implementation of such technologies. We present a novel hybrid approach for making thermoelectric films by combining the conductive polymer blend PEDOT:PSS with an additional inorganic component. This approach is especially appealing because of the high tailorability of polymer morphologies, the comparatively high availability of polymer materials and the possibility for solution-based processing at ambient conditions. We aim for the increase of the state-of-the-art ZT-values of polymer-based thermoelectrics with this new approach.

Modeling and control of wind turbine systems with Permanent-Magnet Synchronous Generators (PMSG) and Doubly Fed Induction Generators (DFIG)

Korbinian Schechner^{a*}, Christian Dirscherl^a, Christoph M. Hackl^a

^a CRES, MSE

*korbinian.schechner@tum.de

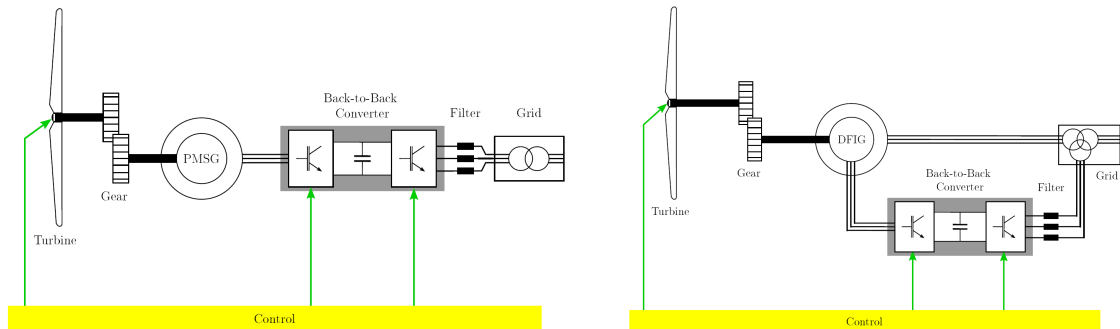

Wind energy is driver of the Energiewende [1]. With an installed nominal capacity of 31,156 MW, wind turbines produced 46,000 GWh electrical power in 2012 in Germany [1]. So wind energy provided 7.7 % of Germany's electrical power demand in 2012 [1]. Moreover, predictions tell a further increase of the installed nominal capacity of wind energy until 2030 beyond the annual peak load [2]. Therefore it is becoming more and more important to understand and train young engineers how wind turbine systems work and in particular, how they can be controlled to comply with grid code requirements (i.e. low voltage ride through) [3]. In this poster the modeling and control of wind turbine systems with Permanent-Magnet Synchronous Generators (PMSG) and Doubly Fed Induction Generators (DFIG) are introduced. At first the structure of the wind turbine systems is presented for each generator topology. The main difference between these two generator types is that the stator of the PMSG is linked via a full-size back-to-back-converter to the power grid (transformer included) (see Fig. 1) whereas the stator of the DFIG is directly coupled to the power grid and the reduced-size back-to-back-converter is installed between the rotor of the DFIG and the power grid (see Fig. 2). Figure 1: Wind turbine system with Permanent-Magnet Synchronous Generator (PMSG). Our modeling focuses on the precise modeling of the electrical components of the wind turbine system (generator, back-to-back-converter, grid filter and power grid) and their interaction. The filter is modeled by a RL-filter and the power grid is assumed to be an ideal symmetrical power supply. The modeling of the mechanical part of the wind turbine system com-

prises gear box and wind turbine. Thereby the amount of extractable power from the wind is characterized by a nonlinear power coefficient which depends on wind speed, turbine speed and pitch angle. Figure 2: Wind turbine system with Doubly Fed Induction Generator (DFIG). The main control tasks are to control (i) the turbine (rotor) speed, (ii) the DC-link voltage of the back-to-back converter and (iii) the reactive power exchanged with the power grid. These tasks are achieved by an intelligent selection of the switching states of the back-to-back-converter. The foci of the poster are on control strategies for rotor speed control and for DC-link voltage control which are both nonlinear problems. This poster discusses a nonlinear control strategy for rotor speed control and two control strategies for DC-link voltage control. For DC-link control, a nonlinear control strategy using input-output linearization and a linear control strategy using linearization around an operating point are presented. Models of the wind turbine systems and their control systems are implemented in Matlab/Simulink. The control performances of the wind turbine systems with PMSG and DFIG are illustrated and compared by simulation results.

[1] Fraunhofer-Institut für Windenergie und Energiesystemtechnik (IWES), Windenergiereport Deutschland 2012“, 2012

[2] Deutsche Energie-Agentur GmbH (dena), Ausbau- und Innovationsbedarf der Stromverteilnetze in Deutschland bis 2030, 2012

[3] M. Tsili, S. Papathanassiou, A review of grid code technical requirements for wind farms, In IET Renewable Power Generation, Vol.3, 2009, pp. 308-332

Wind Energy at Garching - Open source wind park planning

Andrea Schnabl^{a*}

^a Lehrstuhl für Windenergie, Fakultät für Maschinenwesen

*andrea.schnabl@t-online.de

Introduction Wind energy is one of the most significant forms of renewable energy in Germany. Many of the best sites in northern Germany have already been utilized, but in order to reach the stated government target of 80% power from renewables in 2050, all potential sites should be investigated, including those in Bavaria [1]. The goal of the project is to develop an estimate for the wind resource in Garching using open source wind park planning and GIS software and publicly available data. The results are an accurate analysis of the wind energy potential and an estimate of the cost of energy from wind turbine produced electricity in Garching. Tools Using open source programs has two major advantages: the code with the underlying algorithms can be reviewed and the method can be used by everyone. This project uses an open source wind park planning software tool to calculate the wind turbine production data [2]. The AWS OpenWind can be used to plan single turbines or wind parks including wake losses that have to be taken into account for park power optimization. OpenWind offers several methods to include the wake effects of up-wind turbines on the down-wind ones [2]. Along with the aero, mechanical and electrical engineering aspects of wind turbines, this project involves disciplines, including topography, cartography and meteorology. The required geographical information consists of data for elevation, buildings, water bodies, roads, power lines and areas with specific usage or vegetation. For Germany and Bavaria it can be obtained online from the Bundesamt für Kartographie und Geodäsie and the Bayerische Vermessungsverwaltung. The editing of the geographical information is done in open source QGIS [3]. Method In the course of a wind park planning process, the location is usually refined while the project progresses, starting with a wind atlas, eventually leading to a detailed monitoring of the actual wind conditions with an installed met mast. The siting procedure follows the

Wind Resource Assessment Handbook using the GIS data and AWS OpenWind software [4]: a) preliminary screening of a relatively large area using existing wind data sources and topographic indicators to determine promising sites b) survey of the possible sites and ranking c) construction of a meteorological tower to measure wind speed, wind direction and temperature for at least one year (determine diurnal and seasonal fluctuations) d) validation with corresponding long-term reference data. Garching has the advantage of an already installed met mast, whose data can be obtained from the Meteorologisches Institut München (LMU). If the height of the met mast and the hub height do not correspond, the wind speed has to be adapted according to a logarithmic or power law, by taking into account the roughness of the surrounding terrain. The simulation of the performance of the wind turbines is executed in OpenWind. A combination of the wind data and the elevation gives a wind map for the specific site. The remaining geographical information is used to restrict the area based on terrain, federal and regional laws (distance regulations). The cost of energy can then be calculated using an estimation of the turbine cost [5]. Due to the proximity to the Fröttmaning wind turbine and expected site of a second Stadtwerke München wind turbine, results of the analysis should provide insight to the economic feasibility of wind energy near the München metropolitan area.

[1] Bundesministeriums der Justiz und für Verbraucherschutz, Gesetz für den Vorrang Erneuerbarer Energien (Erneuerbare-Energien-Gesetz - EEG). 2008.

[2] AWS TruePower, OPENWIND THEORETICAL BASIS AND VALIDATION V1.3. April 2010.

[3] QGIS, QGIS Benutzerhandbuch 2.0.

[4] AWS Scientific/NREL, Wind Resource Handbook. April 1997.

[5] Fingersh L, Hand, M., Laxson, A. Wind Turbine Design Cost and Scaling Model. Dec 2006.

Morphology evolution of TiO₂ nanostructures by the introduction of anatase nanoparticles

Lin Song^{a*}, Volker Körstgens^a, Daniel Mosegui Gonzalez^a, Yuan Yao^a, Norma Minar^b, Dina Fattakhova-Rohlfing^b, Peng Zhang^c, Stephan Roth^c, Peter Müller-Buschbaum^a

^aLehrstuhl für Funktionelle Materialien, Physik Department

^bAdvanced Materials Science, Department of Chemistry and Center for Nanoscience

^cPETRA III, DESY

*lin.song@ph.tum.de

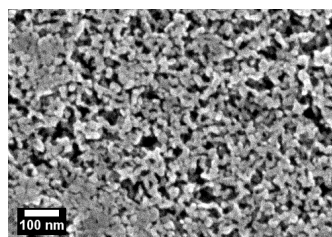
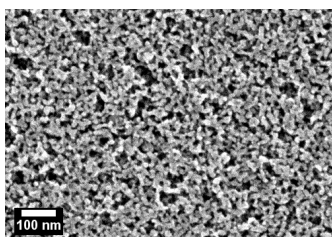
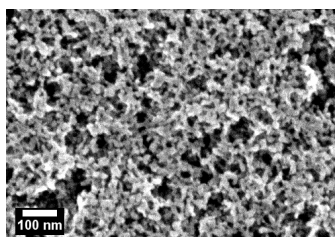

Nanostructured titania thin films have been widely used in a variety of applications such as photovoltaics, photocatalysis, and gas sensing. The optical, electrical, and catalytic properties of TiO₂ could be tuned by its morphology, crystallinity, and particle size. Titania, especially its anatase polymorph, has resulted in a fast upward trend in the field of hybrid solar cell, which consists of conjugated polymers and n-type inorganic nanocrystals. For solar cell applications, a large surface-to-volume ratio of the inorganic semiconductor is desirable, since the morphology influences charge carrier transport routes and the excitation dissociation which occurs at the interface of the inorganic and the organic parts, therewith the probabilities of electron-hole recombination. As a result, well-structured anatase titania favours photocatalytic activity. In recent years, the generalized technique for the synthesis of porous and nanocrystallized titania films is the sol-gel method in

combination with block copolymer templating, which enables the titania films to possess unique and novel mechanical, optical, and electrical properties. To get better crystallinity and more homogeneous distribution of nanocrystal size, in the present investigation we introduce different amounts of customer-made nanocrystallized anatase particles into our block-copolymer-templated sol-gel system. All the SEM images demonstrate porous sponge-like morphologies, irrespective of the different amounts of anatase nanoparticles introduced. However, pore sizes are different and even some clusters appear when the fraction of titania nanoparticles reaches 70%. To investigate the structure information inside the films grazing incidence small angle x-ray scattering (GISAXS) is applied. From fitting these data it is observed that the diameter of the pores shrinks with increasing of amount of nanoparticles.

Optimization of Distribution Transformer Energy Management System with Stationary Battery and Electric Vehicle Charger

Parinya Sonsaard^{a*}, Johannes Dorfner^b, Thomas Hamacher^b

^a Institute of Information Computer and Communication Technology, Sirindhorn International Institute of Technology

^b Institute for Renewable and Sustainable Energy Systems, Electrical Engineering and Information Technology

*parinya.sonsaard@gmail.com

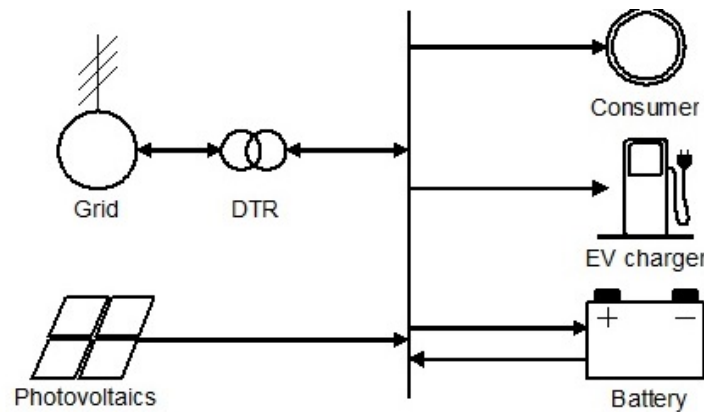

Nowadays environmental concerns such as global warming and rise of fossil fuel prices have led to alterations in the configuration of power systems. New energy resources such as distributed generation (DGs), renewable energy resources (REs), and high-power batteries began to be connected to distribution grids. Electric vehicles (EVs) will charge their batteries at homes. The increasing electricity demand at home due to the increasing EVs charging load can overload and damage existing distribution grid or distribution transformer (DTR). The increasing of REs at DTR it will be reducing the utility's revenue it having to optimize the fuel cost. In this study, we focus on the optimization of the DTR load energy management system (TEMS) subject to constraints of DTR such as its loading, and cost from any sources. DTR is the utility transformer, call distribution transformer, to step down a medium voltage level into low voltage level suitable for connecting to customers, its install distributed in the utility

distribution system. The DTR serves electrical energy to many customer loads. The optimization of DTR, the objective is to minimize the total cost, subject to base load and EVs home charger load. The total cost, including investment cost for new DTR, operation cost, maintenance cost, fuel cost, and revenue is optimized. The benefits of this study are, a cost-minimal investment and scheduling strategy for DTR and an optional stationary high-power battery, the customer can use the base load and the EVs home charger that they want at low cost. Finally, when the utilities using optimization and control algorithm at DTRs. The utilities will get benefits to connect from multiple sources, get more revenue, lower operation and maintenance cost, and less investment new DTR. The customer will satisfy the smarter distribution grid system that they can fully charge EVs at low cost at home. Keywords: transformer energy management system (TEMS), electric vehicle (EV), smart grid infrastructure.

Hierarchically structured titania films for efficient light harvesting in dye-sensitized solar cells

Bo Su^{a*}, Yichuan Rui^{a*}, Martin A. Niedermeier^{a*}, Peter Müller-Buschbaum^a

^a E13 Lehrstuhl für Funktionelle Materialien, Physik Department

*bo.su@ph.tum.de

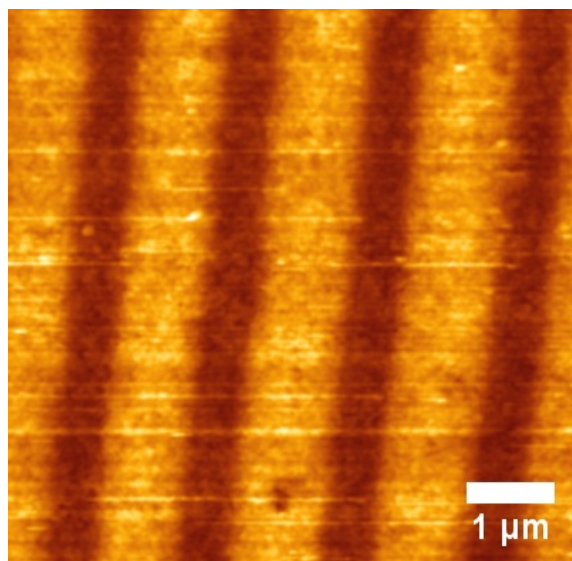
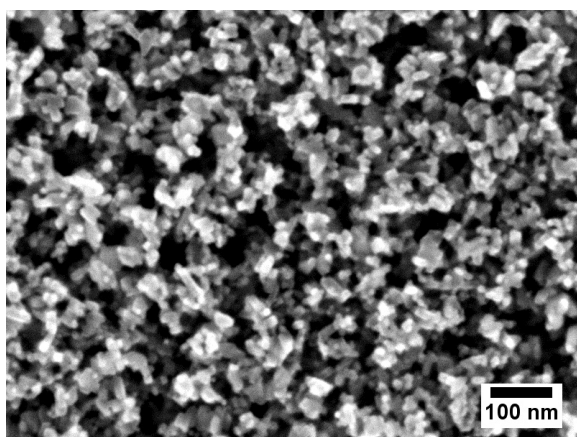

Due to high surface to volume ratio and their bicontinuous morphology, foam-like nanostructures are becoming more interesting in photovoltaics. To improve the power conversion efficiency, the light-trapping strategy is widely used in dye-sensitized solar cells (DSSCs) and organic photovoltaics (OPVs). In our study, we demonstrate hierarchically structured titania films, which are made by sol-gel chemistry and soft-molding method, with an additional superstructure in the sub-micrometer range. The master is prepared by photolithography. Then replica molds are made from the ma-

ster with poly(dimethyl siloxane) (PDMS). Finally, the structured titania films are prepared by PDMS molds. A fairly high level of control over the final morphology is reached via this route. The films are typically prepared via spin-coating, followed by a calcination step to remove the polymer template and obtain crystalline titania. The morphology of these films is characterized with SEM and AFM. The optical properties are determined by UV/Vis spectroscopy and the photocurrent-voltage characteristics of DSSCs are measured.

OEMS Study on the reactivity of anode material Li₁₅Si₄ with carbonate electrolyte

Lorenzo Toffoletti^{a*}, Stefano Meini^b, Hubert Gasteiger^b, Thomas F. Fässler^a

^a Chair of Inorganic Chemistry with Focus on New Materials, Department of Chemistry

^b Chair of Technical Electrochemistry, Department of Chemistry

*lorenzo.toffoletti@mytum.de

Due to its extremely high theoretical specific capacity, silicon is widely considered the most promising candidate to substitute graphite as anode material for Li-ion batteries. A system which is currently drawing a lot of attention is the Silicon-Sulfur Li-ion battery, which in one of its configurations appears as a Li_xSi-S device. In order to use the nowadays highly developed Sulfur cathodes, lithium silicide electrodes have to be developed as well. However, the reactivity of these materials with other battery components (e.g., the electrolyte solution) has not yet been investigated. In this work the reac-

tivity of Li₁₅Si₄-containing electrodes towards an alkyl carbonate-based electrolyte is studied by means of On-line Electrochemical Mass Spectrometry (OEMS). By monitoring the gas evolution of ethylene it was possible to get fundamental understanding of the reactivity of the lithium silicide anode material with the electrolyte solution. It was found that the electrolyte reacts violently at the Li₁₅Si₄-electrode surface, giving rise to a very exothermic reaction and a fast ethylene evolution. The role played by the total electrode surface area was as well thoroughly investigated.

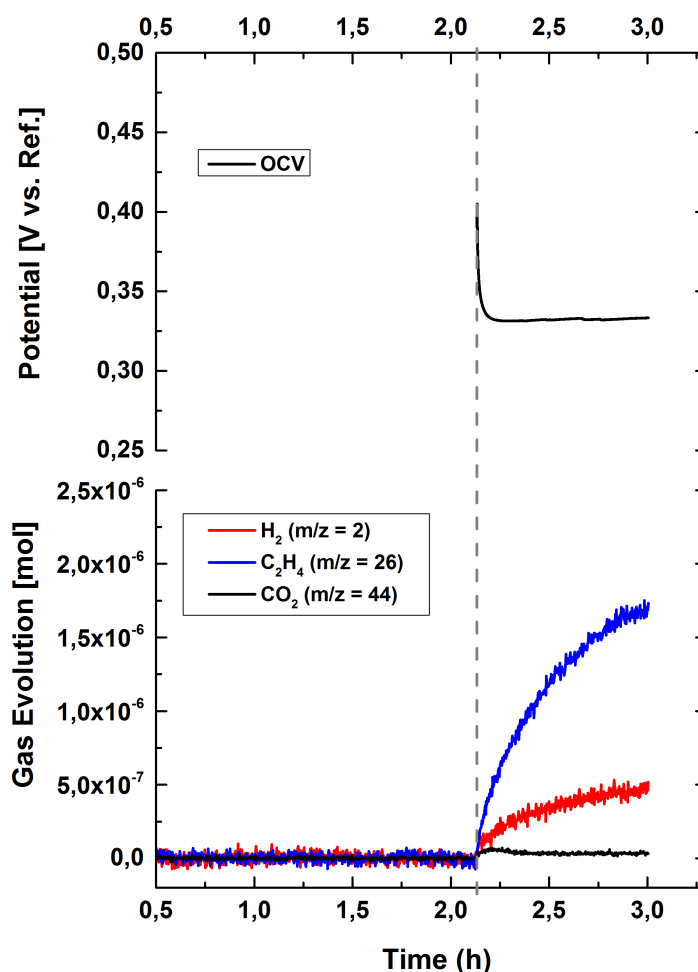

InCharge - Innovative. Intelligent.

Markus Wagner^{a*}, Timo Muntz^a, Andreas Schneider^a, Richard Raßhofer^a

^aLehrstuhl für Energiewirtschaft und Anwendungstechnik, Fakultät für Elektrotechnik und Informationstechnik

*markus.wagner@tum.de



Germany aims to be one of the leading countries in the energy and traffic sector. Everyone is talking about Keywords like sustainability, efficiency and innovative technologies in electro mobility these days. Therefore students from different academic backgrounds developed an intelligent charging station with help from the Lehrstuhl für Energiewirtschaft und Anwendungstechnik at TU in their InCharge project. This project aims to gather practical experience for an intelligent charging infrastructure. The charging is based on algorithm which controls the charging times depending on the electricity prices from the energy market (EEX). In-

itiated in December 2012 the student managed project provides a prototype for an intelligent charging station which is accessible via Touchscreen and Android-App. The prototype is state of the art charging technology with a one-phase (Typ 1) and a three-phase connector (Typ 2). The maximum charging capacity is 22 kW and the maximum charging current is 32 A. The charging process is monitored with a smart meter and evaluated in an internal computer. Further steps will be the implication of an NFC based payment method and on the long run a newly constructed optimized charging station InCharge 2.0.

An overview of life cycle assessment and nearly zero-energy buildings in Germany

Markus Weißenberger^{a*}, Werner Jensch^a, Werner Lang^b

^a Building Services Engineering and Energy Efficiency, Buildings Services Engineering,
Munich University of Applied Sciences

^b Technische Universität München

*markus.weissenberger@hm.edu

This poster presents the historical development and background of life cycle assessment and nearly zero-energy buildings in Germany. In order to plan and build suitably for the future, it is an advantage to have an historical overview about the topic at hand. The life cycle assessment, sometimes called life cycle analysis, is a tool to identify the potential environmental impact of individual materials, whole products or complete buildings. Accordingly, every resource demand of the life cycle of elements is accounted for, from construction through use to disposal (from cradle to grave). Given that the final energy demand during the phase of utilization has steadily fallen, the impact of construction and disposal remains respectively high in terms of the life cycle. This is the case presently in new and modernized buildings, as well as predicted for future-built buildings with low operational energy demand. Additional to EU-guidelines, only nearly zero-energy build-

ings must be built beginning in 2021. These buildings shall have a very low energy demand. This research is based on a review and analysis of the relevant literature shows that the basic idea to consider the energy and material flows holistically goes back to 1884. However, the current applied methodology from life cycle assessment (ISO 14040ff), began in the 1970s. The first requirement for minimum thermal insulation was formulated in Germany in 1934. Nevertheless, since 1977 the energy construction standard has constantly developed and the newest German regulation for energy saving (EnEV 2014) will be implemented this year, and will be tightened even further in 2016. The findings indicate that life cycle assessment has been established as a tool and very low operational energy demand of buildings becoming increasingly common. Hence, the next essential step is to consider the life cycle view of nearly zero-energy buildings.

Flexible hybrid polymer/titania films prepared via low temperature route

Tobias Widmann^{a*}, Weijia Wang^a, Lin Song^a, Peter Müller-Buschbaum^a

^a Lehrstuhl für Funktionelle Materialien, Physik Department

*tobias.widmann@ph.tum.de

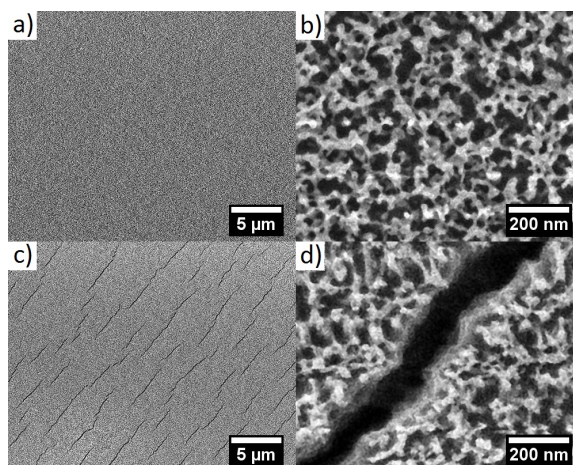
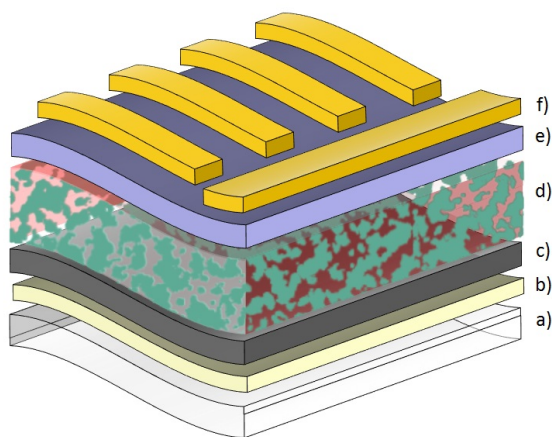

For the future energy supply, photovoltaics are envisaged to have a growing contribution. Today, typical solar cells are based on inorganic semiconductors and most commonly used is silicon. However the developments on conducting polymers opened a new vast research field of organic photovoltaic solar cells. These solar cells benefit from the advantageous properties of the polymers and offer new possibilities such as the large scale roll-to-roll production, cheap routes to highly efficient solar cells and the production on flexible substrates [1]. Flexible solar cells are already used as for example integrated in cloth, bags or as mobile devices like solar panels for battery charging. Hybrid solar cells combine both advantages of inorganic semiconductors and conducting polymers. Titanium dioxide (TiO₂) is a widely used and investigated metal-oxide semiconductor for these hybrid solar cells. Efficiencies up to 2.8 % have been reported using TiO₂ with a porous structure as acceptor and poly(3-hexylthiophene) (P3HT) as the donor materials [2]. However, in order to obtain the TiO₂ anatase phase, typically a high temperature calcination step is performed on the film. This use of high temperatures limits the application on flexible polymer substrates such as for example PET. Hence, a low temperature route that provides good crystallinity for TiO₂ films is necessary. Moreover, a crystalline metal-oxide layer has no innate flexibility. A potential way to overcome these problems is to use TiO₂

film with a high porosity to provide it with sponge like semi-flexible properties. In the present work, this is achieved via a sol-gel process with the help of the novel titania precursor named ethylene glycol modified titanate (EGMT) and a structure directing copolymer poly(styrene-block-ethylene oxide) (P(S-b-EO)) [3]. By micro-phase separation the polymer forms a template where the EGMT is selectively incorporated into the PEO block. Spin coating of the sol-gel leads to a highly porous nanostructured film with a thickness of around 200 nm. The extraction of P(S-b-EO) is done by O₂-plasma. Then the porous TiO₂ film is backfilled with P3HT. All the steps are performed at temperatures below 100°C. To investigate the flexibility of the hybrid thin films, a custom-made bending test is performed on the porous TiO₂ films and the hybrid films. Cyclic bending of the films up to several thousand times is done. Crack formation and propagation on the films are observed with the optical microscope and the scanning electron microscope. The crack depth is probed with atomic force microscopy.

[1] Fraunhofer-Institut für Solare Energiesysteme ISE, Flyer: Organic Solar Cells (2013)

[2] A. Abrusci et al., Energy & Environmental Science 4 (2011) 3051-3058

[3] M. Rawolle et al., ChemPhysChem 13 (2012) 2412 - 2417

Power-to-Gas - Mislead vision, realistic hope for solving the storage problem or even substitute for fossil fuels?

J. Winklmaier^{a*}, A. Drexler^a, T. Hartmann^a, T. Hamacher^a

^aLehrstuhl für Erneuerbare und Nachhaltige Energiesysteme

*Johannes.Winklmaier@tum.de

Besides new flexible power plants, improved demand side management and an extended and smarter transmission grid, new technology concepts for power storages are needed in order to realize the Energiewende in Germany. Traditional systems like hydroelectric pumped storages have a rather small and limited potential in most European countries like Germany compared to the needed storage capacities. The same holds for the idea to use electric vehicles as temporary power storages. Even if 100% of all cars in Germany were driven by electric power trains, they would provide less than 10% of the necessary storage demand identified in future scenarios with 80% renewables. Considering the existing transmission grid and storages for natural gas in most world regions, the Power-to-Gas technology is an interesting option in this context. For instance, today's gas grid in Germany would already be able to satisfy the assumed demand for power storage in 2050. Also decentralized storage close to wind parks or solar farms would be possible with just minor improvement of the existing infrastructure. Moreover, various process end products are possible ? hydrogen, heat, natu-

ral gas, power, LNG or Synfuels ? opening the naming to Power-to-X (P2X). That allows completely new concepts for the manufacturing of sustainable products out of renewable power.

Past events like Fukushima and the Fracking Rush in the U.S. had significant impact on both the worldwide power and fossil resource markets. The future dynamics of these markets are important for the profitability of P2X. Hence, in order to analyze the economic and technological potential of the Power-to-Gas process, all involved markets are studied with special attention on their mutual interaction. Therefore, a combined model considering all involved markets and significant processes is developed. This model allows to analyze the use of the P2X technology as power storage on the one side, but also as a producer for renewable resources and especially fuels like LNG and Synfuels on the other side.

This work is part of the TUM Seed-Funding Project *Power-to-Gas* which is funded by the Munich School of Engineering.

NOTES:

NOTES:

Organizers of the Colloquium:

Maximilian Blume
Angela Brunnbauer
Dr. Cornelia Gotterbarm
Dr. Isabell Nemeth
Dr. Martine Philipp
Benjamin Reuter
Jochen Stopper

Editor:

Prof. Dr. rer. nat. Thomas Hamacher
MSE - Munich School of Engineering
Bolzmannstr. 17
85748 Garching
<http://www.mse.tum.de>

Print:

printy - Digitaldruck & Kopierservice
Bolzmannstr. 15
85748 Garching
<http://www.printy.de>

Number of Copies:

225 Pieces

Date of Publication:

July 2014

Download:

<http://mediatum.ub.tum.de/node?id=1219491>
User name: MSEcolloquium2014/4
Password: energy@TUM2014

urn:nbn:de:bvb:91-epub-20140528-1219491-0-1



CPG Center for Power Generation

 Science Center for Electromobility

NRG Network for Renewable Energy

Zentrum für nachhaltiges Bauen **TUM**