

Monitoring of wide-span timber roof structures - development of a monitoring system

**Robert Pawlowski
Dr.-Ing.**

**Klaudius Henke
Dipl.-Ing.**

**Heinrich Kreuzinger
Univ.-Prof. Dr.-Ing.**

**Stefan Winter
Univ.-Prof. Dr.-Ing.**

**Technische Universität München, Chair of Timber Design and Building Construction
Munich, Germany**

**Peter Schregle
Dipl.-Ing.**

**Impuls computergestützte Bildanalyse GmbH
Gilching, Germany**

Summary

This paper focuses on ways of employing digital image processing in the monitoring of buildings to gauge deformations in wide-span timber roof structures in conjunction with the electronic measuring of snow loads. The practical implementation of digital image processing is introduced and discussed using a pilot project for a gym in Bavaria as an example.

1. Introduction

This topic came into the spotlight with the collapse of the roof of the ice rink in Bad Reichenhall on 2.1.2006 and the extensive research that followed.

But even if a building has been erected according to the regulations, a gap can open up over the years when regulations are changed. A building, for example, that has been built according to German snow loads standard DIN 1055-5:1975-06 no longer meets the standard since the DIN was changed in 2005 and replaced by DIN 1055-5:2005-07, which has been obligatory since 2007-01-01. To begin with, the building can still be operated under the right of continuity. But at the latest when this right expires (for example, when significant modifications to the building structure are undertaken), the building has to be adapted to the up-to-date standard. Normally interventions in the building structure are unavoidable in this case, which often incurs technical difficulties and high costs. At this point, monitoring systems offer an alternative. As far as national law allows, monitoring can to a certain extent replace the reinforcement of the building structure.

This suggests more intensive research in the monitoring of structures, especially wide-span timber structures. The goal is a simple, robust and redundant monitoring system for wide-span timber structures. It will combine traditional methods (such as on-site inspection by qualified specialists) with new technical developments like digital photography, snow load measuring systems and fast, automatic data transmission and use of the internet. This research is to be carried out by an interdisciplinary team.

2. Monitoring design

2.1 Design features

Figure 1 depicts the aspects which are of relevance for designing monitoring systems.

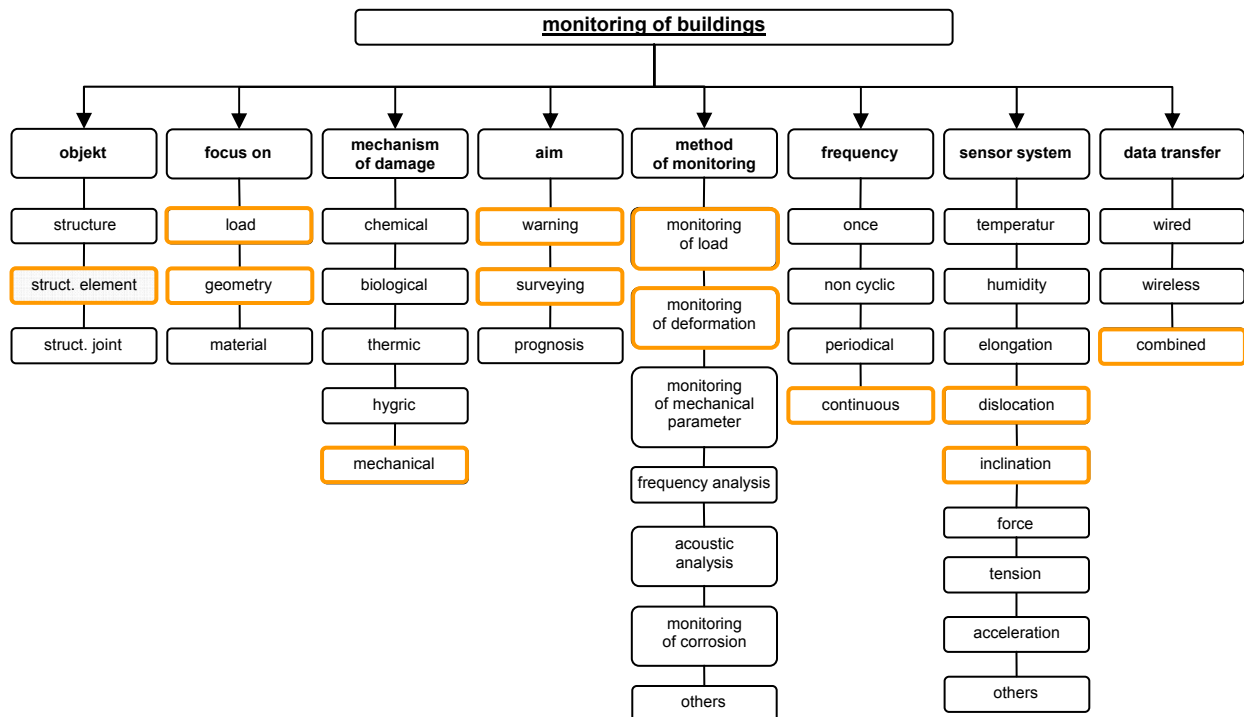

Fig. 1 Monitoring systematics

2.2 Measuring snow loads

Snow loads can be measured either manually or automatically. The automatic methods can be subdivided into the following categories:

- Snow cushion systems: Containers filled with glycol antifreeze. The weight of the snow lying on top of the cushion causes hydrostatic pressure to build up inside the cushion, and this is recorded with the help of pressure sensors.
- Optical surface pressure sensors. It is possible to determine the pressure load incurred by the layer of snow by recording the visual properties of fibre-optic light guides embedded in sensor pads.
- Surface balances. The snow load is determined directly by weighing.

It has to be mentioned, that calibration of this systems is up-to-date insufficient.

2.3 Measuring deformation

There are a number of different systems for measuring structural deformations. Robotic tachymetry is a particularly successful method employed in many areas of structural engineering. Simple light barriers and laser distance gauges are sometimes used, as well. These systems are not discussed at greater depth. Some of them, as in the case of robotic tachymetry, are extremely costly. Other systems are not suitable for continual measuring tasks or are difficult to set up in a building when it is in operation. Against this backdrop we hit upon the idea of transferring industrial image processing methods, as used on production lines in industrial plants for quality control purposes, to structural engineering. These systems combine a high level of accuracy in measuring objects in motion with a low initial outlay. Since they are primarily configured for monitoring small objects under workshop conditions (such as constant light), however, they first need to be modified for deployment in buildings that are in use. Accomplishing this step is the aim of this project.

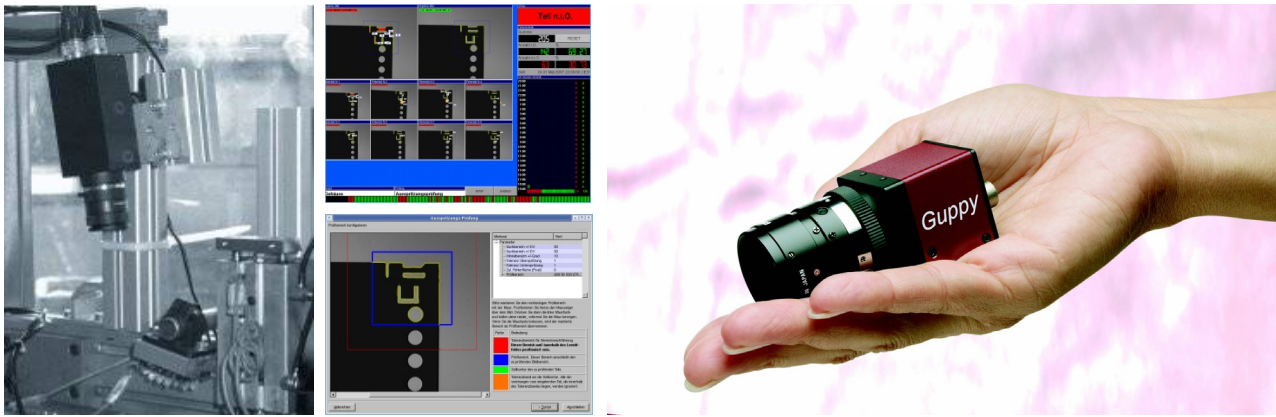

Fig. 2 Digital image processing

3. Pilot project - gymnasium in Bavaria

Within the context of the pilot project a monitoring system based on industrial image processing technology is under development for a gymnasium in Bavaria.

3.1 System, materials, loads

The outer dimensions of the gymnasium are: $W / L / H = 31.55 / 46.08 / 13.00$ m.

The roof structure of the gym consists of the following supports:

- Roof decking, Pos. H1:
Roofing slabs made of particle boards (FPP) according to DIN 68763, thickness $d = 38$ mm.
- Auxiliary beams, Pos. H2:
Glulam BS14 (GL28c), cross-sectional dimensions $W / H = 145 / 650$ to 1400 mm, span (single span girder) $L = 13.01$ to 14.20 m, axial distance $e = 1.25$ m.
- Main beams, Pos. H3:
Glulam BS14 (GL28c), two-beam cross-sectional dimensions $W / H = 2 \times 300 / 2650$ mm, span (single span girder) $L = 31.25$ m.

The operative snow load has been significantly increased since 1.1.2007:

- Snow load to DIN 1055-5:1975-06 (valid until 2006-12-31): $s_0 = 1,50$ kN/m²
- Snow load to DIN 1055-5:2005-07 (valid since 2007-01-01): $s_k = 3,78$ kN/m²



Fig. 3 Gymnasium in Bavaria, Germany

Längsschnitt durch die Hauptträger:

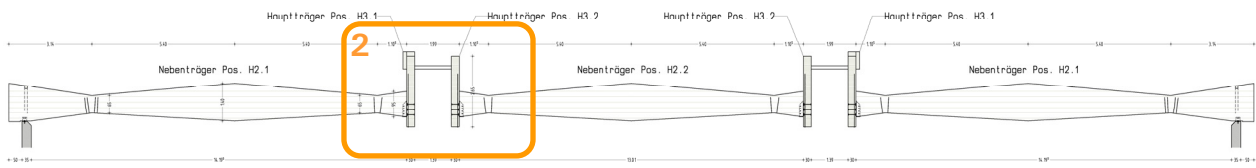

1 Querschnitt entlang des Hauptträgers:

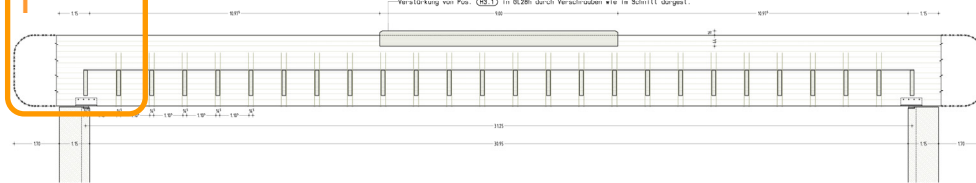

Fig. 4 Gymnasium in Bavaria, Germany – longitudinal and cross-sections indicating details 1 and 2 described below

3.2 Load-bearing capacity of the roof structure

Taking into account the new snow loads according to DIN 1055-5:2005-07 of $s_k = 3.78 \text{ kN/m}^2$, the following operating ratios apply to the most important features of the roof structure of the gym:

- Main beam support:
It is not possible to verify the support for the main beam (Pos. H 3.1) according to DIN 1052:2004-08. The operating ratio on the support according to DIN 1052:2004-08 taking the drift pins present in the joint into account (4 pins $\varnothing 20 \text{ mm}$, S 235) is $\eta = 1.60 > 1.00!$
- Main beams (Pos. H 3.1 and H 3.2):
The operating ratio of the main beam for the full snow load on the roof and on the high beams Pos. H 3 is $1.09 > 1.00$.
- Auxiliary beams (Pos. H 2.1 and H 2.2):
The operating ratio of the auxiliary beam is $\eta = 1.00$.

This means that the load-bearing capacity of the roof structure of the gym is inadequate for the snow loads applicable in Germany since 1.1.2007.

1 Auflagerdetail Hauptträger Pos. H3

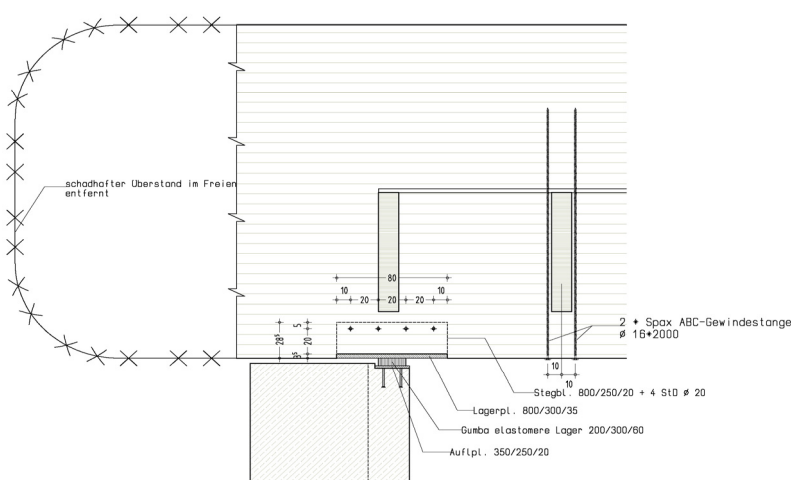

Fig. 5 Main beam Pos. H3 – detail of support

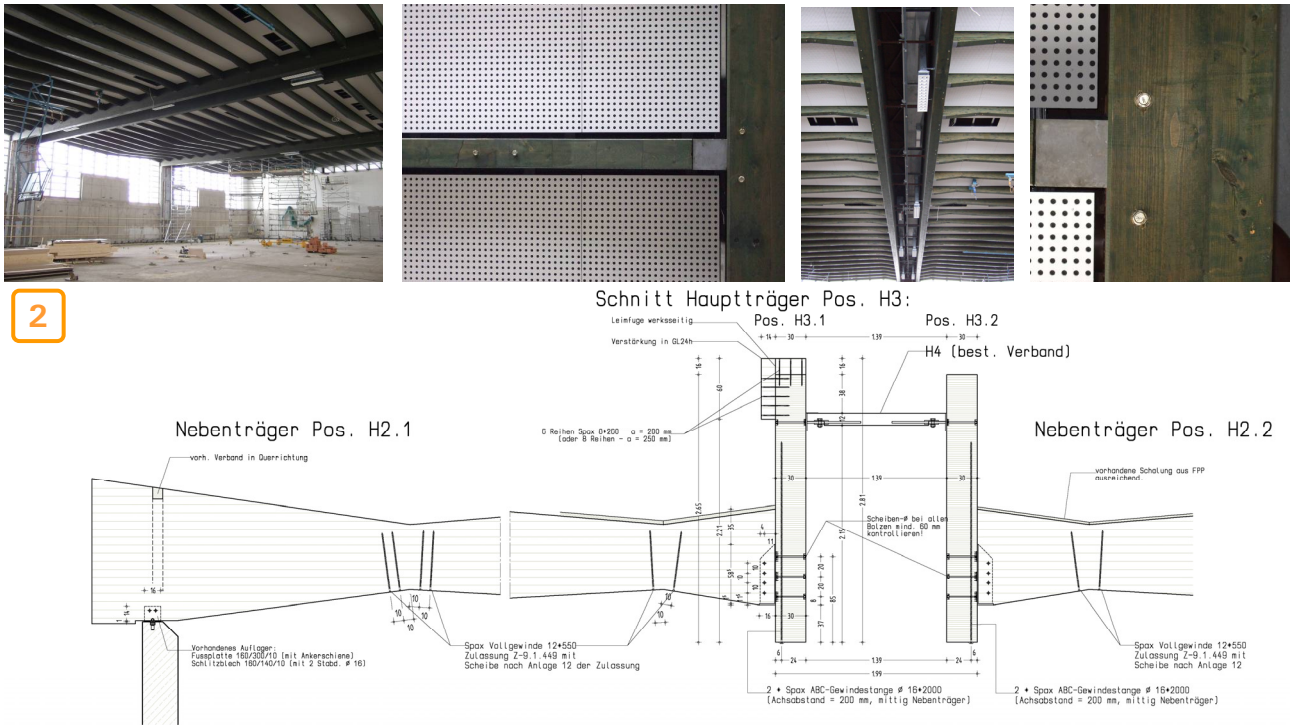
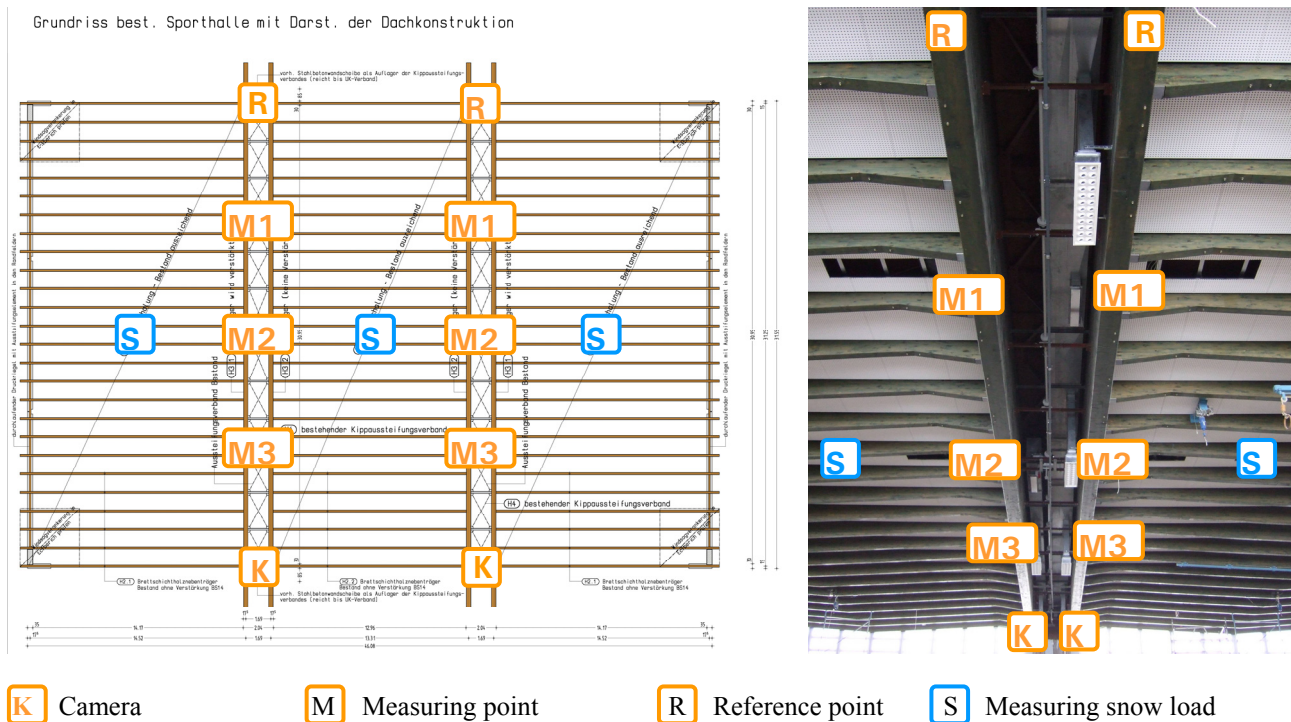

Fig. 6 Main beam Pos. H3 – cross-section with connecting auxiliary beam Pos. H3

3.3 Monitoring system for the gymnasium in Bavaria

In order to determine the actual structural safety situation reliably, a monitoring system is developed for the roof structure of the gym. To this end, a perpetual, electronic measuring system is employed to keep track of the snow load, coupled with an electronic monitoring system for measuring deformations in the roof support based on digital image processing.



K Camera **M** Measuring point **R** Reference point **S** Measuring snow load

Fig. 7 Gymnasium in Bavaria – monitoring system

The monitoring system comprises the following main components:

- Snow load measuring device (S)
- Camera units (K) consisting of two digital cameras connected with one another, one of these cameras being fitted with a processor.
- Measuring points (M), light-emitting diodes (LED)
- Reference points (R), light-emitting diodes (LED)

The aforementioned monitoring system is supported by additional, inexpensive components like laser distance gauges and light barriers to increase the redundancy of the monitoring system close to the boundary condition level for structural safety.

3.3.1 Measuring snow loads

Snow loads are measured automatically using snow load measuring cushions mounted on the roof of the gym. The recorded data are transferred directly via the Internet to our research department at the Technische Universität München. The accuracy of the results is checked by means of regular manual measurements using a snow measuring cylinder.

3.3.2 Measuring deformations

Deformations are measured on the basis of digital image processing. The required camera unit (K) comprises a camera (K1) with an integrated processor (matrix-vision, mvBlueCougar-P, lens with 100 mm focal length and triple converter, fixed aperture, picture frequency of up to 30 images per second) and a camera (K2) without an integrated processor (matrix-vision, mvBlueFox, lens with 100 to 150 mm focal length without converter, self-adjusting aperture and exposure meter). The "smart" camera (K1) functions in the infrared zone and captures images covering an area of about 300 x 400 mm in the middle of the main beam. Its purpose is to record any vertical or horizontal shifting of the measuring points, which are clearly marked by the LED's (M1, M2, M3). To reduce the influence of imperfections in the assembly work and any possible operating inaccuracies, the measuring points (M) always relate to a fixed point of reference (R), which is mounted within the camera's line of vision but outside the movable roof structure area. Since the photos are taken by the camera (K1) within the infrared range and the camera is also equipped with a daylight filter, the quality of the images is not affected by lighting conditions in the gym. The camera can be operated with a fixed aperture during the daytime and the night-time. The size of the aperture only has to be aligned to the brightness of the LED's. The images captured by the smart camera (K1) are capable of detecting movements at the points marked by the LED's, down to a millimetre. The picture frequency and data storage rate are regulated by the results: i.e. the number of images required per unit of time depends on the speed and the extent of the sagging as well as the weight of the snow load and the increase in the amount of snow.

Since the information on the images taken in the infrared zone is masked out in the visible light range, another camera (K2), without an integrated processor, is connected to the "smart" camera (K1) for taking images in the visible light range. In order to take informative pictures even in the event of the roof structure collapsing, however, a lens with a shorter focal length is used in this case. The images can be triggered at a frequency of up to 30 pictures per second. The changing light conditions between the day and night are offset by a variable lens, automatic exposure metering and artificial light.

The LED's used here are conventional light diodes with a diameter of 3 mm and 5 mm respectively. They have a lifespan of over 100,000 hours (about 11½ years of continuous light).

Preliminary tests, simulating the actual layout of the measuring points, were carried out at the Technische Universität München to check and agree on the camera optic. One measuring point (M) in the form of a LED was positioned at a distance of 15 m according to the location of the measuring point (M2) and moved vertically. A second LED was positioned 30 m away by way of a reference point (R). It was possible to identify the shift in the location of the measuring point (M) with an accuracy to within a matter of millimetres. In addition, to estimate the influence of any misalignment

of the measuring points, the LED's were twisted horizontally. Since angular deviations do not lead to a change in the position of the measuring or reference points and merely cause a reduction in the luminous intensity of these points, tolerances of up to 15 degrees can be accepted without any serious deterioration in the results. Figure 10D clearly shows that the measurements in the infrared range are ideal for accurately determining the position of individual LED's. Figure 9 shows the measuring system's resilience to deviations in the alignment of the LED's.

Figures 8 and 9 depict the aforementioned results of the preliminary tests at the Technische Universität München:

A) Daytime image taken within the spectrum of visible light (without daylight filter, with infrared filter), powerful source of front light, closed aperture, relevant for camera (K2).

B) Image taken in very dim light (simulating light conditions at night-time within the spectrum of visible light, without daylight filter, with infrared filter), open aperture, relevant for camera (K2).

C) Image taken within the infrared range (without infrared filter), open aperture, relevant for camera (K1).

D) Image taken within the infrared range (without infrared filter), closed aperture, relevant for camera (K1). It is possible to locate the position of the LED's to within a millimetre.

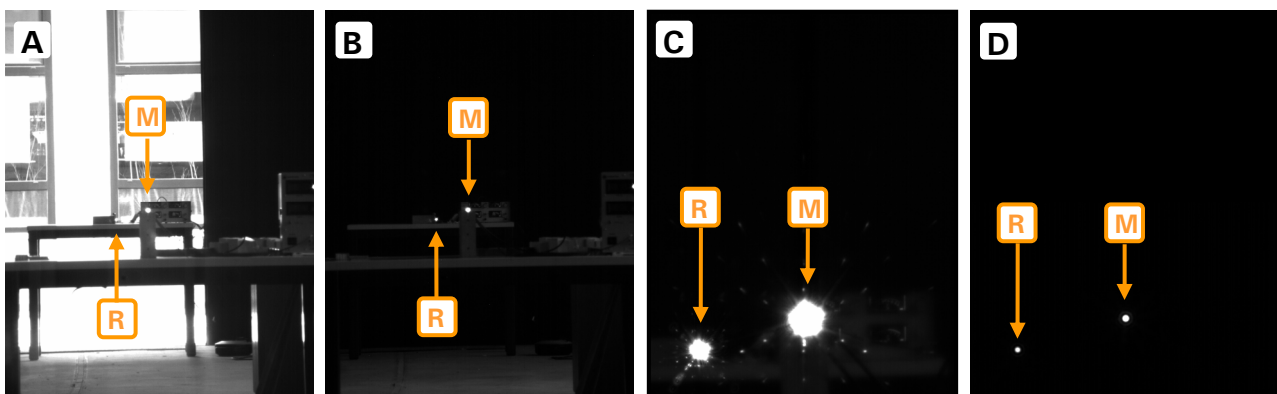

Fig. 8 Preliminary tests: camera view by using different filter and aperture

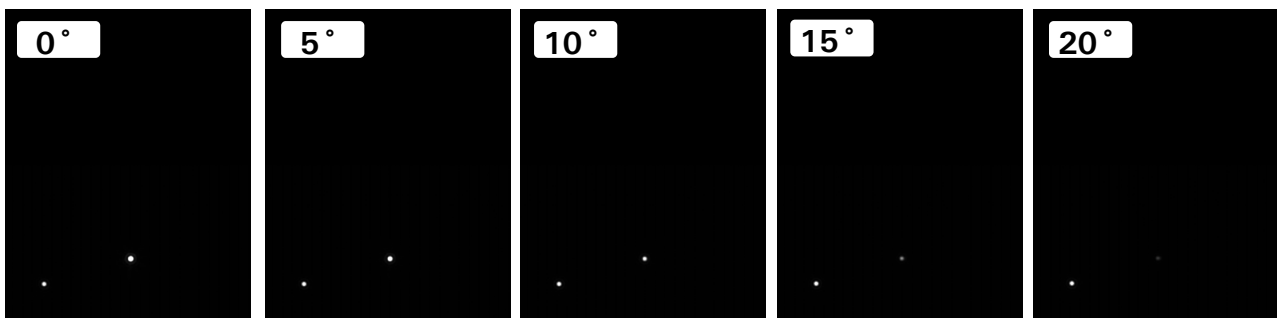

Fig. 9 Images with misaligned LED (M)s, angle of deviation from the camera axis – LED: 0°, 5°, 10°, 15° and 20°

Based on these preliminary trials, a deformation monitoring system has been developed for the gym in Bavaria – see structural diagram in Figure 10. The position of the measuring points (M1), (M2), (M3) in the output image is used to determine the deformed geometry of the main beam Pos. H3. Together with the snow loads that are recorded at the same time, it is possible to ascertain the actual load-carrying behaviour of the main beam and compare it with the static model calculation that was conducted beforehand. By defining deformation limits according to the amount of physical strain the roof structure is subjected to, it is possible to devise a system of alarm levels for the use of the gym.

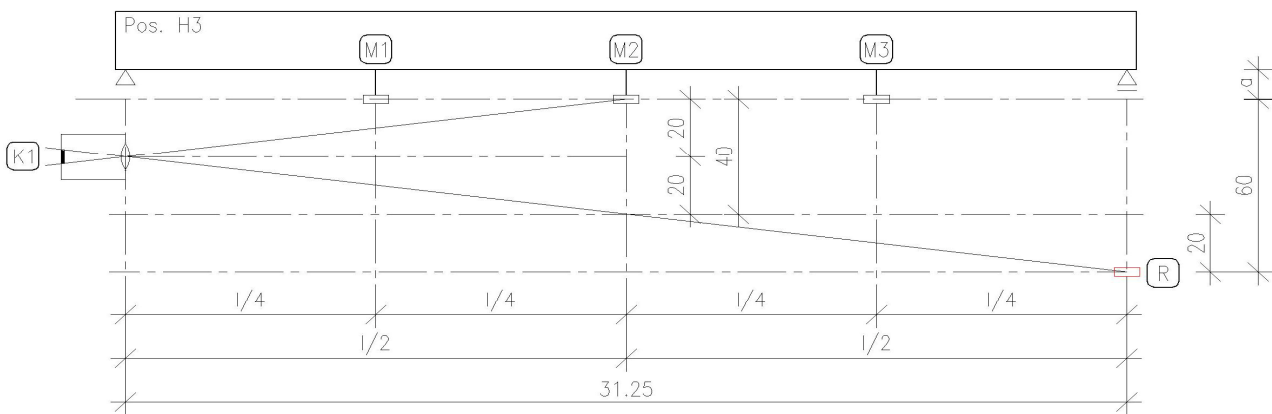

Fig. 10 Monitoring – diagram of system – elevation

3.4 Data transfer

The data resulting from measuring the snow load and deformation are transferred by cable connection via Ethernet to a conventional computer located in the installations room of the gym. From there the data is forwarded via the Internet to a server of the Technische Universität München. An emergency power supply ensures an uninterrupted functioning of the monitoring system.

4. Discussion and conclusions

The system, based on digital image processing, which is employed here in connection with the measurement of snow loads, displays the following characteristics:

- continual measurement of the snow load and deformations,
- fast identification of the load-bearing behaviour depending on the snow load,
- it is possible to determine existing load-bearing reserves,
- graphic imaging process: disturbances (such as ball-throwing) are recognised,
- clear portrayal of results,
- independent of light in the infrared range (suitable for unrestricted day and night operation),
- high precision
- existing redundancy
- restricted but adequate number of measuring points
- much more economical than tachymetry

5. Acknowledgements

Landratsamt Garmisch-Partenkirchen, Bavaria, Germany

6. References

- [1] Winter, S., “Der Einsturz der Sporthalle in Bad Reichenhall und was man daraus lernen muss”, *Zuschnitt*, Vol. 25, March 1994, p. 17.
- [2] Heisig, F., *Bauwerksmonitoring – Methoden der kontinuierlichen Überwachung von Bauwerken*, Diplomarbeit, Lehrstuhl für Holzbau und Baukonstruktion, Technische Universität München, September 2007.