

Technische Universität München  
Fakultät für Architektur



Study on  
Computer-Aided Design Support  
of Traditional Architectural Theories

By  
Seung Yeon Choo

- 
- Institut für Entwerfen und Gestalten
    - Lehrstuhl für Grundlagen der Gestaltung und Darstellung, Prof. Rudolf Wienands
  - Institut für Entwerfen und Bautechnik
    - Fachgebiet CAAD, Prof. Richard Junge

**Technische Universität München**

Institut für Entwerfen und Gestalten  
(Lehrstuhl für Grundlagen der Gestaltung und Darstellung)  
Institut für Entwerfen und Bautechnik  
(Fachgebiet CAAD)

**Study on Computer-Aided Design Support  
of Traditional Architectural Theories**

Seung Yeon Choo

Vollständiger Abdruck der von der Fakultät für Architektur  
der Technischen Universität München zur Erlangung des  
akademischen Grades

**eines Doktor-Ingenieurs**

genehmigten Dissertation.

Vorsitzender : Univ.-Prof. Dr. phil. Norbert Huse

Prüfer der Dissertation :

1. Univ.-Prof. Richard Junge

2. Univ.-Prof. Dr.-Ing. Rudolf Wienands

Die Dissertation wurde am 01.12.2003 bei der  
Technischen Universität München eingereicht und durch  
die Fakultät für Architektur am 26.01.2004  
angenommen.



## Acknowledgement

This thesis was carried out with the invaluable aid of Prof. Rudolf Wienands and Prof. Richard Junge of the Department of Architecture at the Munich University of Technology.

Prof. Wienands has supported me with valuable advice on the section concerning traditional architectural theories and Prof. Junge on the section dealing with the computer-aided architectural design and product information models. I would like to deeply thank them for all the support they have given me, and for the fact that they agreed to take over the tutorship of my doctoral thesis.

I would also like to thank the assistants of Prof. Junge, Dipl.-Ing. Roland Göttig and Dipl.-Ing. Stefan Kaufmann, for their friendship and the advice on multimedia.

In particular, I am very grateful for the financial support I have received through a grant from the "Konrad-Adenauer-Stiftung" for all the periods of my work. I will always have good impressions of Germany, owing to the kindness and the help of Prof. Fritz, the Gleixner's family and the Nicolodi's family; I thank you all.

However, carrying out my thesis would not have been possible without additional help from my parents, my wife (Young-Jin Lee) and Prof. Sun-Nam Yu, which I appreciate very much. Finally, one of the best experiences that I had during this period was the birth of my son, Sanghun Choo, who provided an additional and joyful dimension to my life's mission.

I would like to express my gratitude to all of them and especially the God who always helps me when I suffer spiritually.



## Abstract (eng.)

The research presented in this thesis describes a computer-aided design support of traditional architectural theories.

Traditional architectural theories in western architecture have been considered as a basis for answering the fundamental questions of architecture: proportion, symmetry, colour, harmony and so on. In particular, the aesthetic aspect of these theories has been one of many important architectural aspects, and which is concerned with the field of architecture in determining the beauty of architectural form. The most significant role of the traditional theories in architecture is to maintain unity, to avoid chaos and then to achieve harmony in a design, using some specific design principles.

However, current technology-guided constructions tend to neglect often the importance of these theories due to the standardization of building elements, due to mechanically-prepared construction and the reducing completion costs, etc.

Thus, this research proposes a design support system as a design assistant that gives an intelligent advice on architectural design, using analytical design- and ordering-principles of traditional theories for the optimization of the architectural design from the aesthetic perspective.

To evaluate the aesthetic quality of an architectural design, this system is implemented in the AutoCAD environment, using the AutoLISP. It is applied so as to explain and develop aesthetic qualities of a design. Designs proposed by this system include optimum designs, which are based on the traditional architectural theories, and new ones which can be

in future connected to information models. To do this, the definition of information about building elements is accomplished by using the neutral format EXPRESS and EXPRESS-G for such application systems.

The results of the application system are presented, such as the easily generating and quickly conceptualising of an object model, the checking of the aesthetic value of the design during the various design phases, the helping to find direction during rational searching for a solution. The user can easily appreciate the usefulness of the proposed system as a set of tools for searching for rational architectural aesthetics and formal solutions at different design-stages.

It is to be hoped that a new "traditional" fundamental of architecture, such as the proposed system, incorporating CAAD systems, will find its place among new technological methods in the AEC industry and so help to bridge the gap between the value of traditional architecture and CAAD systems.



## Abstract (ger.)

Diese Dissertation befasst sich mit der Untersuchung von Anwendungsmöglichkeiten der traditionellen Gestaltungstheorien, wie z.B. Harmonie, Proportion, Takt und Rhythmus, Farbenlehre, und deren Implementierung in CAAD-Systeme. Allgemeines Ziel der Arbeit ist es, an einigen Beispielen Möglichkeiten zu zeigen, wie die Quantifizierung von Qualität mit Hilfe von CAAD-Unterstützung erfolgen könnte.

Traditionelle Architekturtheorien zielen oft darauf ab, eine gestalterische Einheit zu erzeugen, das Chaos zu vermeiden und „Harmonie“ zu erzeugen. Im Besonderen benutzt die sogenannte „Ästhetik“ oder Bestimmung der Schönheit von Architekturformen immer wieder bestimmte Ordnungsprinzipien, Ähnlichkeiten und oder Kontraste, um ein spannungsvolles Verhältnis von Ordnung und Chaos, von Gleichartigkeiten und Verschiedenartigkeiten zu erzeugen. Seit Jahrhunderten, scheiterten, vielen Gestaltungstheorien wie Farb- und Harmonie-Lehre, Proportions- und andere Ordnungs-Systeme am Problem der großen Zahl – d.h. der nicht mehr praktikablen viel zu komplizierten Zahlreichen oder Verhältnisgleichungen.

Seit kurzen erst gibt es Computer bei der Planung und gestalterischen Kontrolle für problemlose Bewältigung komplizierter Zahlenwerke hinter den Gestaltungstheorien. Gegenwärtig rücken durch Computerbasierte Methoden und durch die Standardisierung von Bauten und Bauteilen, sowie durch die Maschinengesteuerten Fertigungstechniken zur Reduzierung von Baukosten, etc., die ästhetischen Aspekte der Baugestaltung in den Hintergrund.

Daher wird ein Computerunterstütztes Entwurfssystem in dieser Dissertation vorgeschlagen, der die Qualität der architektonischen Gestaltung überprüft und, unter Verwendung analytischer Ordnungsprinzipien der traditionellen Architekturtheorien, optimiert.

Um die Qualität der Gestaltung im Entwurfsprozess zu evaluieren, wird jedes Gestaltungsprinzip mit Hilfe der Programmiersprache AutoLISP in die AutoCAD-Umgebung implementiert. Dieses System schlägt dann dem Benutzer einige dieser auf traditionellen Architekturtheorien basierende Alternativen vor. Es sieht darüber hinaus die Implementierung in Bauteilbasierte Gebäudemodelle vor. Dafür werden die Informationen der Bauteile mit dem neutralen Format EXPRESS und EXPRESS-G für solche Systeme definiert.

Der hier entwickelte Entwurfsassistent ist in der Lage, einfach und schnell abstrakte Objektmodelle zu generieren, und deren gestalterische Qualität zu prüfen, zu variieren und zu optimieren. Er soll dem Benutzer bei der komplexen Suche nach ästhetisch ansprechenden Lösungen in den verschiedenen Entwurfsphasen helfen.

Es ist zu hoffen, dass neue „traditionelle“ Gestaltungsmethoden, wie das vorgeschlagene System, in den Computerbasierten Planungsprozess der Bauindustrie Eingang finden wird und helfen kann, eine Brücke zwischen traditioneller Architektur und CAAD Systemen zu schlagen.



# Contents

---

## **1. Introduction**

---

- 1.1 Motivation**
- 1.2 Objective and Scope of the Research**
- 1.3 Structure of the Thesis**

---

## **2. Importance of Traditional Architectural Theories in Contemporary Architecture**

---

- 2.1 What is Aesthetics in Architecture?**
- 2.2 Role of Multimedia in Contemporary Architecture**
- 2.3 Development of CAD and CAAD**
- 2.4 Increasing Demand for Classic Architectural Theories in Design and Construction**

---

## **3. Analysis of Design and Ordering Principles in Architecture**

---

- 3.1 Design Control using the Ordering System of Architecture**
  - 3.1.1 Axes and Grids
  - 3.1.2 Symmetry and Proportion
  - 3.1.3 Rhythm and Balance
- 3.2 Colour Theory of Architecture**
  - 3.2.1 Overview of Colour Characteristics
  - 3.2.2 Colour Contrasts
  - 3.2.3 Psychological Effect of Colour on Architectural Space
  - 3.2.4 Colour Harmony



### **3.3 Design Principles of Formal Ordering for Harmonious Architecture**

3.3.1 Unity through Similarity

3.3.2 Ordered Complexity

3.3.3 Summary

---

## **4. Information Modelling for Integration of Design Applications**

---

### **4.1 Information Modelling**

4.1.1 What is an Information Model?

4.1.2 Methods of Information Exchange

4.1.3 Information Model Format

### **4.2 Standard for the Exchange of Product Model Data (STEP) as Basic Integrated Information Model**

4.2.1 Structure of STEP

4.2.2 STEP Information Models

### **4.3 EXPRESS**

4.3.1 History of EXPRESS

4.3.2 EXPRESS Dialects

4.3.3 EXPRESS Language Concepts

4.3.4 Application of EXPRESS in Other Standards

### **4.4 Industry Foundation Classes (IFC)**

4.4.1 Background and Structure of IFC

4.4.2 IFC Releases History

4.4.3 Modern Perspective of IFC

### **4.5 Information Modelling of a Façade**

4.5.1 Real- and Abstract-World in an Information Model

4.5.2 Information Data Model of a Façade

---

## **5. Application Design Modelling of the Architectural Principles in the AutoCAD Environment**

---

- 5.1 Design Process and the Application Model**
- 5.2 Basic Mechanism and Structure of the Programme**
  - 5.2.1 Basic Mechanism of the Programme
  - 5.2.2 Structure of the Programme
- 5.3 Schema and Process of Information Model**
  - 5.3.1 Conceptual Schema in Information Model
  - 5.3.2 Process for the Development of Information Model
- 5.4 Sub-Systems for Aesthetic Measurement**
  - 5.4.1 Subsystem of Musical Rhythm between Windows
  - 5.4.2 Subsystem of Musical Proportion
  - 5.4.3 Subsystem of Harmonious Relationship between Columns and Spacing
  - 5.4.4 Subsystem of Harmonious Proportion
  - 5.4.5 Subsystem of Mass Modelling for Optimization of Three Dimensions
  - 5.4.6 Subsystem of Diagonal Regulating Lines
- 5.5 Testing the Developed Methods**
  - 5.5.1 Diagonal Regulating Lines
  - 5.5.2 Harmonious Proportion
  - 5.5.3 Musical Proportion
  - 5.5.4 Harmonious Relationship between Columns and Spacing
- 5.6 Discussion**

---

## **6. Conclusion**

---

Bibliography



## List of Figures

Fig.1	An example of Shape Grammars by George Stiny .....	1
Fig.2	An example of Shape Grammars by William J. Mitchell .....	2
Fig.3	Computational alternative plan-studies in the Palladian style by William J. Mitchell ..	2
Fig.4	Technical structure of architecture in the IFC2x of IAI .....	4
Fig.5	Le Corbusier's Modulor .....	5
Fig.6	Vitruvius' Ten Books on Architecture .....	11
Fig.7	Gustav Fechner, shape preference experiment using a set of ten cards .....	12
Fig.8	NOX architects, Beachness, Noordwijk ....	16
Fig.9	Günter Behnisch, Theatre- and Concert-Hall, Bristol, 1998 .....	16
Fig.10	Frank Gehry, View and the digitized plan of the curved surfaces based on the computer controlled milling in the Disney Concert Hall, L.A., 2003 .....	16
Fig.11	Peter Eisenman, Glass model of "Haus Immendorff", 1993 .....	17
Fig.12	Peter Eisenman, Computer drawing of wire frame .....	17
Fig.13	Peter Eisenman, Computer study of building skin .....	17
Fig.14	William J. Mitchell, Illuminating Clay .....	18
Fig.15	Real columns and computer modelling of columns in the St. Familia Cathedral ...	18
Fig.16	Nicholas Grimshaw, View of the Biomes, 1998 .....	18
Fig.17	Buckminster Fuller, Union Tank Car Dome at Baton Rouge, Louisiana, 1959 .....	19

Fig.18	Frei Otto, Roof structure of a baths-facility in Borkum, 1966 .....	19
Fig.19	Nicholas Grimshaw, Analysis of structure of the Biomes using a computer .....	19
Fig.20	Process of a car-modelling with SKETCHPAD .....	21
Fig.21	Column of extrusion in the 2½D-system ....	22
Fig.22	Clipping in the 2½D-system .....	22
Fig.23	New function for construction .....	22
Fig.24	IBM 1620 .....	23
Fig.25	HP 9845 .....	23
Fig.26	Axis of Parthenon, Athens, Greece .....	27
Fig.27	Axes of Villa Rotonda, Palladio .....	28
Fig.28	Grid of chessboard .....	29
Fig.29	Grid in the Villa Medici .....	29
Fig.30	Folie-plan in La Villette, Paris .....	30
Fig.31	Symmetrical plan of Parthenon .....	31
Fig.32	Example of bilateral- and radial-symmetry .....	31
Fig.33	Number series in Timaeus .....	33
Fig.34	Module of Parthenon .....	33
Fig.35	Triglyphs and Metopes .....	33
Fig.36	Human proportion, Leonardo da Vinci ....	34
Fig.37	Square root proportion .....	34
Fig.38	Andrea Palladio, Recommended plan-shapes for rooms .....	35
Fig.39	Ratios of Golden Section .....	35
Fig.40	Golden proportion in the façade of Parthenon .....	35
Fig.41	Divisions for the relationship showing musical proportions .....	36
Fig.42	Integer series of musical proportion .....	37
Fig.43	Musical consonance between the sequences 6, 8, 9, 12 .....	37
Fig.44	Floor-plan and analysis of proportion system in Villa Malcontenta .....	38

Fig.45	Blue- and red-series in Modulor .....	40
Fig.46	Single and double bisections of a line AB according to the Golden Section .....	41
Fig.47	Single and double bisection of a line AB according to the Plastic Number .....	41
Fig.48	The order of size embraces seven consecutive types contained within eight measurements .....	42
Fig.49	Relationship between the measurements	44
Fig.50	Two dimensional diagram of measurements of the Plastic Number ....	44
Fig.51	Three dimensional illustration of measurements of the Plastic Number ....	45
Fig.52	View of the square of Telc, Czech Republic .....	48
Fig.53	Analysis of façade of Telc .....	49
Fig.54	Rhythm used by Le Corbusier in the La Tourette .....	49
Fig.55	Rhythm used by Le Corbusier in the Visual Arts .....	49
Fig.56	Colour always dominates form .....	52
Fig.57	Balance through colour contrast .....	52
Fig.58	Balance through form .....	53
Fig.59	Balance through text .....	53
Fig.60	Ford Foundation Building .....	53
Fig.61	Balance through position .....	53
Fig.62	Piet Mondrian's sketch concerning balance .....	54
Fig.63	Balance in the Pantheon of Liberty and Democracy by Oscar Niemeyer .....	54
Fig.64	Intensities of Green .....	56
Fig.65	Value scale .....	56
Fig.66	Six-colour wheel .....	58
Fig.67	Twelve-colour wheel .....	58
Fig.68	Twentyfour-colour wheel .....	58
Fig.69	Contrast of hue .....	59

Fig.70	Strong light-dark contrast .....	60
Fig.71	Examples of light-dark contrast .....	60
Fig.72	The first and standard warm-cold colour diagram .....	60
Fig.73	Strong visual impact of the cool background, by using cold-warm contrast .....	61
Fig.74	The mix of each complementary colour	61
Fig.75	An example of complementary contrast	62
Fig.76	Examples of size contrast .....	62
Fig.77	Applications of Goethe's size contrast ....	63
Fig.78	Size contrast in a façade .....	63
Fig.79	Simultaneous contrast relating to size .....	63
Fig.80	Colour shift in a simultaneous lightness contrast .....	64
Fig.81	Colour shift in a simultaneous chroma contrast .....	64
Fig.82	Colour shift in a simultaneous hue contrast .....	64
Fig.83	Colour diagram and effects of saturation contrast .....	65
Fig.84	Real and Sensitivity Axes .....	65
Fig.85	Shift of Sensitivity Axis by colour contrasts	66
Fig.86	Shift of Sensitivity Axis by the lightness of colour .....	66
Fig.87	Colour schema and colour effect .....	67
Fig.88	Spatial effect using colour accent .....	68
Fig.89	Spatial effect by colour intensity .....	68
Fig.90	Spatial effect by colour tone .....	69
Fig.91	Guidance of walking path by colour accent .....	69
Fig.92	Guidance of walking path by colour tones .....	69
Fig.93	Guidance of walking path by colour intensity .....	69
Fig.94	Colour triads 1 .....	71

Fig.95	Colour triads 2 .....	72
Fig.96	Colour diagrams of primary colour harmony .....	74
Fig.97	Group of large elements and group of small elements .....	78
Fig.98	View of an old city in Stockholm .....	78
Fig.99	Similarity of form, scale and proportion	79
Fig.100	Richard Meier, Front Entrance of MACBA .....	80
Fig.101	Chaos between colours .....	80
Fig.102	Unity between colours .....	80
Fig.103	New City Hall in Bensberg, Germany .....	81
Fig.104	Similarity between various scales .....	82
Fig.105	Similarity between various textures .....	82
Fig.106	Similarity between various colours .....	83
Fig.107	Similarity between various conditions .....	83
Fig.108	View of the Willits House .....	85
Fig.109	Access axis in the Willits House .....	86
Fig.110	View of the Philharmonic Concert Hall, Berlin .....	86
Fig.111	Access Axis in the Philharmonic Concert Hall, Berlin .....	86
Fig.112	Main façade of Farnese Palace, Rome	86
Fig.113	View of the La Tourette .....	87
Fig.114	Three components of rhythm in the La Tourette .....	87
Fig.115	Complexity in checkerboard .....	88
Fig.116	Complexity in San Lorenzo .....	89
Fig.117	Relationship between the elements of formal aesthetics .....	90
Fig.118	Three kinds of data exchange .....	93
Fig.119	Example of IGES file .....	95
Fig.120	Example of SET file .....	95
Fig.121	EXPRESS and EXPRESS-G relationship .....	106
Fig.122	Overview of the EXPRESS-G notation .....	106

Fig.123	Evolution of 2D graphics into object- Integrated models .....	110
Fig.124	An interpretation of IFC2.0, showing a subset with focus on the IfcBuildingElement .....	111
Fig.125	Modules within the IFC Architecture ...	112
Fig.126	New processes in Release2.0 .....	114
Fig.127	New processes in Release3.0 .....	114
Fig.128	Purpose of information models .....	117
Fig.129	An abstraction of the real-world .....	118
Fig.130	The representation of a door is illustrated on the left as a layered CAD drawing and on the right as an example of an information model ....	118
Fig.131	IfcPositiveLengthMeasure in the IFC2x	120
Fig.132	IfcObjectPlacement in the IFC2x .....	121
Fig.133	The information structure for a structural layer .....	122
Fig.134	The information structure for an opening .....	123
Fig.135	The information structure for a surface	123
Fig.136	The information structure for a column	124
Fig.137	The overall EXPRESS-G diagram of the façade .....	125
Fig.138	Derivation path of Queen Anne house by Ulrich Flemming .....	126
Fig.139	Conceptual schema of a façade ....	135
Fig.140	Musical tone and corresponding Hz. ..	139
Fig.141	Musical structure and ratios .....	140
Fig.142	Proportion of a rectangle .....	144
Fig.143	View of St. Ursula .....	148
Fig.144	The diagonal regulating lines of the floor-plan in St. Ursula .....	149
Fig.145	Proportion recommended by Kayser .	150
Fig.146	Harmony through repetition of the fundamental diagonal lines .....	151



Fig.147	Floor-plan of an elementary school .....	151
Fig.148	Optimization of the floor-plan using the diagonal regulating lines .....	152
Fig.149	A façade of a building .....	153
Fig.150	Position of elements in a façade .....	153
Fig.151	Result after using the programme .....	153
Fig.152	Monotonous placement of columns ....	154
Fig.153	Rhythmic placement of columns after using the programme .....	154
Fig.154	View from the Hofstallgasse, Salzburg ...	155
Fig.155	Model photo of the museum .....	155
Fig.156	The east façade of the museum in Salzburg .....	155
Fig.157	Applying the music to the east, west, south and north façade .....	156
Fig.158	Original elevation of a building .....	158
Fig.159	Alternative thickness of the columns ....	158
Fig.160	Result after using the programme .....	158
Fig.161	Interior of a room .....	159
Fig.162	Recommended series of the Plastic Number in the interior of the room .....	159
Fig.163	Element relationship between object- based and non object-based CAD system .....	161
Fig.164	Collaboration today .....	165

## List of Tables

Table 1	Definitions of Aesthetics .....	13
Table 2	Types of computer-use in architecture .....	20
Table 3	Alberti's recommended proportions for each area .....	38
Table 4	System I , II , III .....	43
Table 5	System I , II , I a .....	43
Table 6	System II , III, II a .....	43
Table 7	A measurement-system for the ancient temple columns .....	46
Table 8	Five types of orders and the corresponding ratios according to the Plastic Number .....	47
Table 9	Different symmetrical time-rhythms ..	51
Table 10	Six basic types of colour by Paul Renner .....	73
Table 11	Fourteen types of relationships for achieving harmony within a group of buildings .....	84
Table 12	History of the national standardization of information exchange formats .....	96
Table 13	List of AP's .....	99
Table 14	Description of Ap's .....	101
Table 15	List of IR's .....	102
Table 16	EXPRESS dialects within ISO10303 .....	107
Table 17	Design process and use of the application system .....	130
Table 18	Example of AutoLISP programme .....	131
Table 19	Process diagram of the information model .....	137



## Index of Abbreviations

<b>AAM</b>	Application Activity Model
<b>AEC</b>	Architecture, Engineering and Construction
<b>AIC</b>	Application Integrated Construct
<b>AIM</b>	Application Interpreted Model
<b>AP</b>	Application Protocol (in the context of STEP)
<b>API</b>	Application Programming Interface
<b>ARM</b>	Application Reference Model
<b>CAAD</b>	Computer-Aided Architectural Design
<b>CAD</b>	Computer-Aided Design or Drawing
<b>CFI</b>	CAD Framework Initiative
<b>CORBA</b>	Common Object Request Broker Architecture
<b>DICE</b>	DARPA Initiative in Concurrent Engineering
<b>ER</b>	Entity-Relationship (Semantic data modelling language by Chen)
<b>FM</b>	Facility Management
<b>IAI</b>	International Alliance for Interoperability
<b>IDEF</b>	ICAM DEFinition Language
<b>IDL</b>	Interface Description Language
<b>IFC</b>	Industry Foundation Classes
<b>IR</b>	Integrated Resource
<b>ISO</b>	International Standards Organization
<b>IT</b>	Information technology
<b>NIAM</b>	Nijssen Information Analysis Method, A graphical information modelling language
<b>NIIP</b>	National Industrial Information Infrastructure Protocols
<b>OMG</b>	Object Management Group
<b>PDM</b>	Product Data Model
<b>POSC</b>	Petrotechnical Open Software Corporaton
<b>SDAI</b>	Standard Data Access Interface

<b>SPF</b>	STEP Physical File
<b>STEP</b>	STandard for the Exchange of Product model data
<b>VRML</b>	Virtual Reality Modelling Language

Man becomes an abstraction when he shuts his eyes  
and becomes absorbed in all the possibilities.  
If he builds, he does so with his eyes open;  
he looks with his eyes. Architecture is judged  
by eyes that see, by the head that turns,  
and the legs that walk.

- Le Corbusier

# 1. CHAPTER

## Introduction

---

### 1.1 Motivation

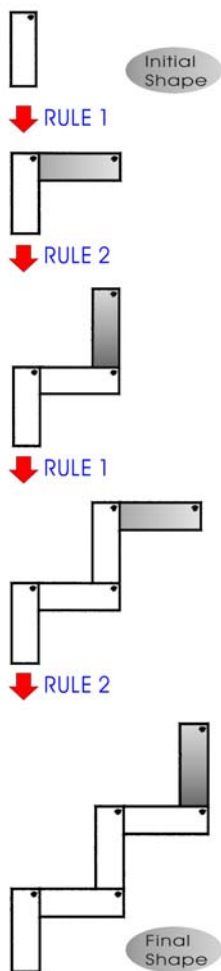

Fig.1 An example of Shape Grammars by George Stiny

Today, architectural design tasks are supported by means of computers. The main reason for this is that designing is a problem-solving process including aesthetic, functional and structural aspects, which require a dynamic way of handling information involved in the design process. Since the 1960s, computers have been enthusiastically embraced. Nicholas Negroponte, in his book “The Architecture Machine <sup>1</sup>”, discussed theories and ideas for the use of artificial intelligence in architecture, investigating the possible relationships between architect and machine, including that of a partnership, in which the machine and the architect would learn and grow from their interaction. The computer has been considered an integral part of the design process, and the discipline of architecture as a whole, revolutionizing its methods.

Efforts in computational design are largely characterized by two methods.<sup>2</sup> One method focuses on the design of a system of production and analysis, such as grammars, syntaxes, and similarly-defined languages. The other method tends to focus on the adaptation and the evolution, along with the related processes of complexity, self-organization and

---

<sup>1</sup> Nicholas Negroponte, *The Architecture Machine – Toward a more Human Environment*, The MIT Press, Cambridge, 1970

<sup>2</sup> Benjamin Loomis, *SGGA-A user-driven genetic algorithm for evolving non-deterministic shape grammars*, Working paper, MIT, 2000, p.2

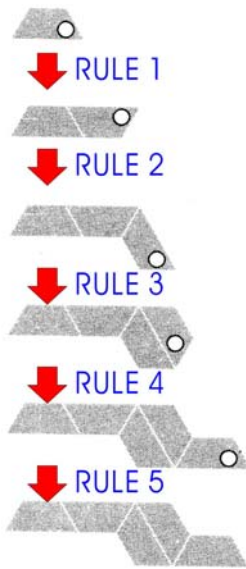

Fig.2 An example of Shape Grammars by William J. Mitchell

emergence. Among the works in each trend of thought about computational design methods, shape-grammars and genetic algorithms stand out as being the most best established fields in this research.

Shape grammars are mathematical devices by which designs can be created according to rules. They have been proved to be capable of producing a complex and meaningful design language, as exemplified by the Palladian, Prairie and Queen Anne house-grammars and are theoretically capable of producing any design. Shape grammars are useful in generating new designs. So, they can be applied to analyze and interpret existing works of architecture. This approach is developed in the work of George Stiny, William J. Mitchell, Ulrich Flemming and others.<sup>3</sup>

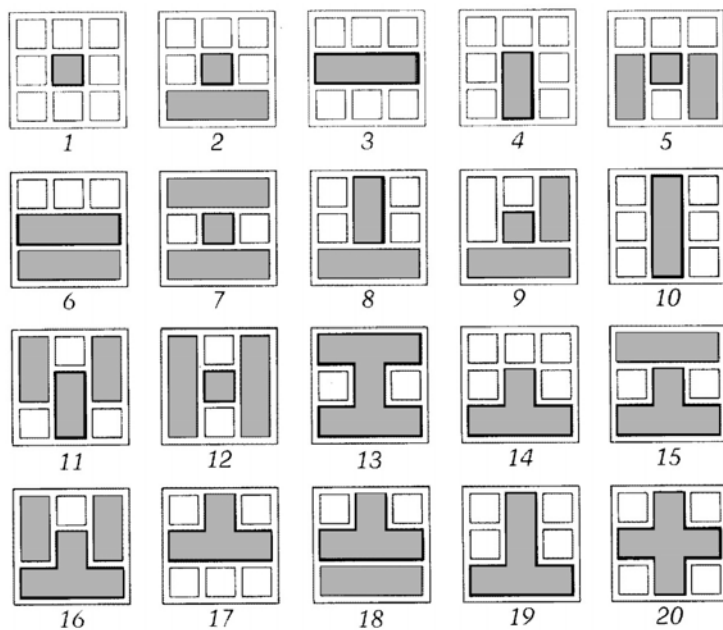

Fig.3 Computational alternative plan-studies in the Palladian style by William J. Mitchell

Genetic algorithms are a search and optimization technique which works based on evolutionary principle of natural chromosomes. Specially, the evolution of chromosomes due

<sup>3</sup> See the book "The Electronic Design Studio" by Malcolm McCullough, William J. Mitchell and Patrick Purcell, The MIT Press, Cambridge, 1990

to the action of crossover and mutation and natural selection of chromosomes based on Darwin's survival-of-the-fittest principles are all artificially simulated to constitute a robust search and optimization procedure. In architecture, genetic algorithms are recognized as a powerful problem-solving method, with a wide range of theorems and applications which suggest their optimality for solving many types of problems.

Despite the significant body of knowledge currently available in these areas, these models have rarely produced practical software solutions for the AEC (Architecture, Engineering and Construction) industry, because most of the already-developed systems were primarily experimental research-prototypes that could not gain the interest of the industry.

Parallel to these efforts, another line of research was focussing on the product modelling of AEC objects. Today's modern communication technologies (Internet, Intranet, ISDN etc.) offer many possibilities for computer-based concurrent engineering. In order to use these technologies effectively, there has to be a holistic and unified product model providing the underlying semantics.<sup>4</sup> In this case, the product model plays a significant role in proposing the semantic based data-exchange. Product modelling is an acknowledged method of describing the specific definitions of very complex products.

The starting point of its development was in the 1970s. Since its initial development, including GLIDE and BDS, the fundamental structure of the product model has become clearer through the further development of the next generation, such as Expert System in the 1980s.<sup>5</sup> The product model evolved into a separate research-line within the AEC/IT

---

<sup>4</sup> Richard Junge, Rasso Steinmann and Klaus Beetz, A Dynamic Product Model-A base for distributed applications in the CAAD futures 1997, Kluwer Academic Publishers, Dordrecht, 1997, p.618

<sup>5</sup> Richard Junge and Thomas Liebich, Product Data Model for Interoperability in an Distributed Environment in CAAD futures 1997, Kluwer Academic Publishers, Dordrecht, 1997, p.574



(Information Technology) community that primarily focussed on the use of standard data models to facilitate systems integration and interoperability. In particular, this area was studied as part of the IAI (International Alliance for Interoperability) approach; that is, Industry Foundation Classes (IFC). Several data models for AEC objects were proposed by the IFC.

Fig.4 Technical structure of architecture in the IFC2x of IAI

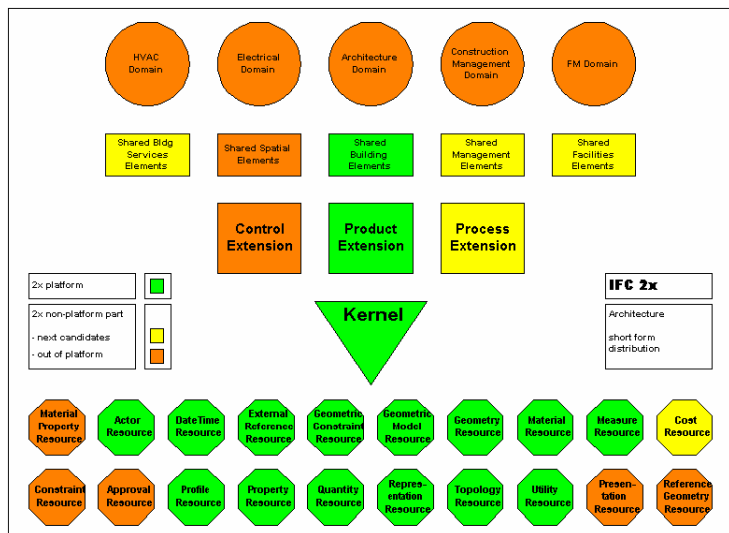

In spite of the developments in these areas of research, the commercial applications used in the architectural office have mainly focused on CAD<sup>6</sup> as a production-drafting tool. At present, most designers use computers in various aspects of the profession, from drafting to data processing operations, but very few think of the computer as a design medium. Furthermore, there seems to be a lack of relation to “aesthetic” aspects of a design in the above mentioned research projects; these were concerned with generating and analyzing designs, producing analogous plans of famous architects and data exchange, in which there are no considerations of “quality assessment of design qualities (Quantifizierung von Qualitäten der Gestaltung)”. The aesthetic aspect of an architectural design has always been

<sup>6</sup> The definition and history of CAD is described in Chapter 2.

one of many design aspects that have to be considered in an architectural problem. Moreover, many studies have been done on architectural theories since ancient times, especially theories of “proportion and harmony”, which are concerned with the most important principles for determining the beauty of an architectural form.

No tools seem to exist that can compete with these traditional ways of designing. Therefore, this research proposes a design support system as computer-aided design assistant that evaluates and aids an architectural design, using analytical design and ordering principles of traditional architectural theories on the optimization of the planning of architectural design from the aesthetic perspective. The model we present takes a designer’s approach, and is about practical synthesis and gains in understanding rather than strict adherence to theoretical possibilities.

---

## 1.2 Objective and Scope of the Research

The objective of this dissertation is to search out the fundamental design principles from traditional architectural theories first and then to develop the application system of those principles in the computer-aided architectural design world, along with the information model such as STEP or IFC, for object-orientated information concept and for data exchange between different CAD systems.

As the first stage of this thesis, the analysis of the fundamental design principles in architecture is an essential prerequisite to both wider understanding of complex designs and to the evaluation of aesthetic qualities. There are many ideas about what the fundamental principles of design are, from the ancient Vitruvius architectural theory to Le Corbusier’s one. Through the survey of these ideas, the important aspects of architecture can be roughly divided into

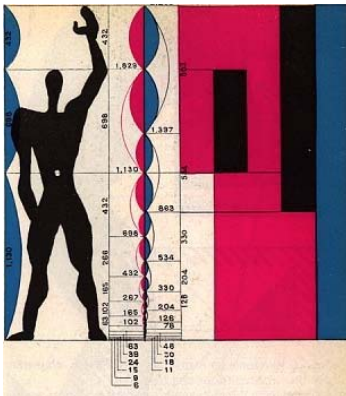

Fig.5 Le Corbusier's Modulor

three categories: visual satisfaction and suitability for intended uses, including the constructability. Certainly, an architect has to perform his duty as an artist, to make the building look “visually satisfying”. No doubt “suitability for intended uses” and “constructability” deal with functional and structural aspects of building design.

The architect is responsible for designing the building “visually”, “functionally” and “stably”. In particular, this research describes the aspect of visual satisfaction rather than functionality and constructability of architecture, as it is beyond the scope of this thesis to investigate all the intricacies of both cases.

The second stage of this thesis is the translation of design principles to CAAD-language. The design principles based on the CAAD technology need to be considered, in order to optimize the aesthetic quality of an architectural design in a CAAD system. To do this, it must be assumed that the creative design, which depends on a human’s own spiritual capability, lies with the designer himself. The proposed design model in this research focuses on the premise that the computer only assists aesthetic tasks of a design, while producing the alternative optimum designs and then helping a designer to improve the planning; that is, it has been developed under the concept “computer as design assistant”; the users, for example, architects or architectural students can communicate and improve the design from the early phases, such as sketches to the end of the designs with their own computers.

The system that will be described in this thesis is based on the use of analytical design principles. In this analysis, the aesthetic evaluation relies on principles of harmony, proportion, rhythm, musical proportion and so on.

This design support system gives an outline of a new approach to linking a human’s decision-making process of a

design to an intelligent use of commercial CAD-applications through the medium of the information model of the IAI that is a developed method for facilitating the exchange of information (i.e., data and meaning in context).

The proposed system is a development programme for CAAD, which can be extended to a product model, and consists of the following: firstly, a survey of the most important concept of information modelling technology is provided and the concepts are illustrated by describing the design and implementation of the information model with the neutral format language "EXPRESS/EXPREE-G" in this section.

Secondly, it is demonstrated how design qualities are integrated and developed under the information modelling concept automatically. For implementation, this model is written as a plug-in to AutoCAD using AutoLISP. It is a dialect of the LISP programming language which includes some scripting capabilities so as to access AutoCAD's built-in commands.

In the end, architects can benefit from being conscious of advising and testing of operations of this design model during compositional and aesthetic development and during data exchange associated with the information model. The advantage of operating with programmed aesthetic concepts in this way is that they provide architects with an explicit method, not only for helping to simplify the human's decision-making process of complex designs, but also for the easy refinement of geometrical and spatial structures of designs.

---

### **1.3 Structure of the Thesis**

Chapter 1 gives an introduction to the thesis by describing current trends in the computational design, including the information models of the IAI in architecture, and problems addressed. Additionally, this chapter describes the aims and

scope of the research.

Chapter 2 describes the concept of aesthetics in architecture, which will be used as the theoretical outline for evaluating a design quality, and the role of multimedia in contemporary architecture. Multimedia not only empowers our imagination, but also provides opportunities for verisimilitude to support decision-making. In addition, the importance of traditional architectural theories that are a solution to increasing aesthetic expectations of clients, incorporating CAAD programmes, is discussed so as to keep up with the current international situation in architecture.

Chapter 3 presents analytical fundamentals of architecture; formal ordering-systems, colour harmonies and design principles. In architectural design, the use of design and ordering-systems can be apparent immediately by just looking at a design, although the final design is complex. At this point, it is crucial to find a formal methodology, which can clearly elucidate different levels of the use of these systems. This chapter describes different kinds of design- and ordering-principles, which can be applied to the CAAD system.

Chapter 4 presents an information model for integration of design models, which will be implemented in the AutoCAD environment, using the neutral format language "EXPRESS/EXPRESS-G". This model has as its objective the development of theoretical foundations and methods of the design principles e.g. aesthetic properties with the framework of STEP technology.

Chapter 5 describes the application design support system where the theories of previous chapters have been evaluated. This chapter consists mainly of formulas for aesthetic measurement, basic programme mechanisms and process, and application tests of the design system.

This model is described with regards to how the proposed design principles are implemented in the AutoCAD system and how easily a designer can improve the design.

Chapter 6 presents the main results of the application design model and the final conclusion. It also formulates some recommendations for practical applications and future research.

## 2. CHAPTER

# Importance of Traditional Architectural Theories in Contemporary Architecture

---

### 2.1 What is Aesthetics in Architecture?

The word “aesthetics”, which is frequently used by architects, must be understood in its fullest meaning. We all have our personal whims and fancies and our preferences seem to depend on our aesthetic tastes. Even almost whimsical and sensitive decisions are the result of an innate aesthetic process. The definition of aesthetics has existed for over 2000 years. The meaning of aesthetics varies according to each period. We can summarize the definition of aesthetics from ancient times as follows:

Plato (427-347 B.C.) divided aesthetics into two fields: natural and customary aesthetics. Natural is from geometry, consisting of uniformity and proportion. Customary aesthetics is begotten by the reaction of our senses to those objects which are usually pleasing to us for other reasons, for instant, familiarity, or particularly inclination both of which breed a love of things not in themselves lovely.<sup>7</sup> Aristotle (384-422 B.C.) subjectified aesthetics. According to his theory, architecture is an expression of mathematical aesthetics and is created incorporating a harmony, symmetry and order.<sup>8</sup>

---

<sup>7</sup> P.H.Scholfield, *The Theory of Proportion in Architecture*, Cambridge University Press, London, 1958, p.76

<sup>8</sup> Thomas Thilo, *Klassische chinesische Baukunst – Strukturprinzipien und soziale Funktion*, Edition Tusch, Wien, 1977, p.220



Fig.6 Vitruvius' Ten Books on Architecture

Vitruvius (about 100 B.C.) saw the aesthetics in *eurhythmia* and *symmetry* and determined it as a relation between separate parts and the whole, so that nothing can be changed in an organism which is complete and perfect; that is, aesthetics is achieved when a building has a pleasant and agreeable appearance, and when the symmetry of the components has been correctly calculated.<sup>9</sup> He formulated the definition of symmetry with regard to the then current sense of proportion. Plotin (205-270) described aesthetics as the source of spirit that can be experienced sensually, and Augustinus (354-430) regarded aesthetics as numbers; that is, numbers are recognized in a certain form.<sup>10</sup>

The meaning of aesthetics can be summarized during the Renaissance as follows, in Leon Battista Alberti's (1404-1472) classic definition:

*I shall define Aesthetics to be a harmony of all the parts in whatsoever subject it appears, fitted together with such proportion and connexion that nothing could be added, diminished or altered, but for the worse...*<sup>11</sup>

He described aesthetics as an agreement between the harmony of the parts and the total, in accordance with numbers, proportion and order.<sup>12</sup> Andrea Palladio (1508-1580) stood by Vitruvius' theory that aesthetics should be combined with function and construction of a building. His definition of aesthetics was based on Alberti's: aesthetics originates in the beauty of a form and in the analogy of the total with the single parts. For Palladio, aesthetics is not an abstract definition, but concretely experienced in connection

---

<sup>9</sup> Rudolf Arnheim, *Die Dynamik der architektonischen Form*, Köln, 1980, p.152

<sup>10</sup> Paul von Naredi-Rainer, *Architektur und Harmonie*, Köln, 1982, p.16

<sup>11</sup> Leon Battista Alberti, *The Ten Books of Architecture*, The 1755 Leoni Edition, Dover Publication, New York, 1986, p.113

<sup>12</sup> Paul von Naredi-Rainer, *op.cit.*, p.23



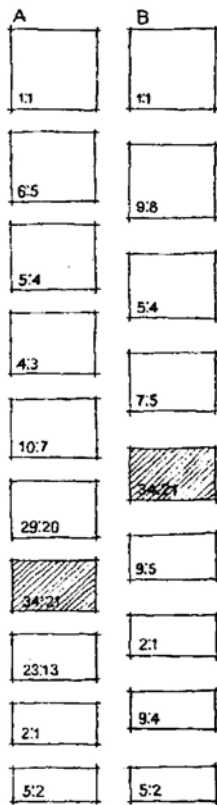

Fig.7 Gustav Fechner, shape preference experiment using a set of ten cards

with architecture.

The term “aesthetics” became even more subjectified from the 18<sup>th</sup> century onwards; subjective elements play at least some part in determining our sense of beauty.<sup>13</sup> Subjective words such as taste, feeling and perception were incorporated into the meaning of aesthetics. For instance, Immanuel Kant (1724-1802) was convinced that taste alone was capable of judging aesthetics. George Friedrich Wilhelm Hegel (1770-1831) distinguished between natural aesthetics (Naturschönheit) and artificial aesthetic (Kunstschönheit), following Plato’s and Kant’s opinions.<sup>14</sup> According to Hegel, perception of artificial aesthetics is not innate within people, but has to be learned. Gustav Fechner (1801-1887) attempted to formulate and qualify the relationship between charm as aesthetic information and its absorption by the observer.<sup>15</sup> In this way, perception became a scientific discipline.

Aesthetic ideals, for example aesthetics of nature and geometry, first became apparent to Frank Lloyd Wright and Le Corbusier: the former derived his definition of aesthetics from nature, especially from organic architecture, and the latter, as an advocate of modern technology from forms of modern engineering products. Le Corbusier’s work is unified by a mutual basis in numbers. His proposed aesthetics of architecture is made clear in the opening words of *Towards a New Architecture*:

*The Engineer’s Aesthetics, and Architecture, are two things that march together and follow one from the other: the one*

<sup>13</sup> P.H.Scholfield, op.cit., p.p.75-76

<sup>14</sup> George F.W. Hegel, *Einleitung in die Ästhetik*, München, 1967, p.20

<sup>15</sup> Fechner used a set of ten cards for shape preference experiment. As shown in Fig.7, the hatched shapes are approximately a  $\emptyset$  rectangle which were chosen by the great number of subjects. His series A is compared with an alternative series B, in which the  $\emptyset$  rectangle is shown to be roughly the geometric mean between the extremes.

*being now at its full height, the other in an unhappy state of retrogression. The Engineer, inspired by the law of Economy and governed by mathematical calculation puts us in accord with universal law. He achieves harmony.*<sup>16</sup>

The change in definition of aesthetics is summarized in Table 1:

Table 1  
Definitions of Aesthetics

Period	Author	Key to aesthetics definition
Ancient	Plato	Natural and customary beauty
	Aristotle	Mathematical beauty: Harmony, Symmetry, Order
	Vitruvius	Symmetry (Proportion)
	Plotin	Sensual experience
	Augustinus	Numbers
Renaissance	Leon Battista Alberti	Harmony of number, proportion and order
	Andrea Palladio	Harmony
18 Century	Immanuel Kant	Personal preference
	George F.W. Hegel	Natural beauty and Artificial beauty
	Gustav Fechner	Satisfaction of human perception
Modern	Frank Lloyd Wright	Organic beauty
	Le Corbusier	Engineering beauty, Mechanical beauty

As we see in Table 1, the meaning and concept of aesthetics has changed over time and differed between each culture. However, common factors among main key aesthetic points are found; that is, harmony and order.

In his book "Architecture and the human Dimension", Peter F. Smith regarded harmony as proportion<sup>17</sup>. Palladio and Alberti also proposed the harmonious relationship between number, proportion and order for architectural aesthetics. V. Cousin noticed in 1953 that aesthetics is not achieved by regularity and conformity, but by using the following opposite qualities:

<sup>16</sup> Le Corbusier, translated by Frederick Etchells, Towards a New Architecture, Dover Publication, New York, 1986, p.1

<sup>17</sup> Peter F. Smith, Architecture and the human Dimension, George Godwin Limited, London, 1979, p.11

unity and complexity. R. Padovan argued in his book "Proportion" that the elimination of complexity tends towards disorder and the absence of order is not complexity but confusion. He noticed, additionally, the relationship between order and complexity that just as order needs complexity to become manifest, complexity needs order to become intelligible.<sup>18</sup>

This relationship is also described in P. Smith's and J.K.Grütter's book as having the same meaning; P. Smith regarded this relationship as an example of the second order aesthetics and Grütter described the relationship as the tension between order and complexity<sup>19</sup> (Spannung zwischen Ordnung und Komplexität).

---

## 2.2 Role of Multimedia in Contemporary Architecture

Computer and telecommunications have revolutionized traditional perceptions of space and time. The concept of multimedia has begun to play a significant role in designs.

The move toward virtual worlds in the multimedia of today is accelerating and there is increasing evidence of their commercial viability. VRML (Virtual Reality Modelling Language) has become, almost overnight, a de facto standard for the modelling and publishing of three dimensional projects, which can be experienced in real-time over the Internet.<sup>20</sup>

The cyberspace created by using multimedia has been increasingly used in the media to denote a digital world which exists in contrast to the physical one.<sup>21</sup>

The modification in the architectural world induced by

---

<sup>18</sup> Richard Padovan, Proportion – Science, Philosophy, Architecture, E&FN Spon, London and New York, 1999, p.p.40-41

<sup>19</sup> Jörg Kurt Grütter, Ästhetik der Architektur – Grundlagen der Architektur-Wahrnehmung, Kohlhammer, Berlin, 1987. p.153

<sup>20</sup> Eden Muir and Rory O'Neill, Architecture of Digital Space in [www.arch.columbia.edu/DDL/research/ddl.human.html](http://www.arch.columbia.edu/DDL/research/ddl.human.html) (1995)

<sup>21</sup> Daniel Bertol, Visualizing with CAD, Springer-Verlag, New York, 1994, p.XX

computers is part of a radical societal change. Its scale is comparable with industrialization, the invention of the letterpress, of the electric light, of the phone or the railroad.

A survey in 1995 indicated that 36% of Americans' homes were equipped with computers and 18% with modems ready to be connected to the "Net".<sup>22</sup> These numbers will continue to rise, as prices fall for computers and digital services, leading us towards an era of ubiquitously networked computing. It is estimated that the US online population will reach about 210 million by 2004. That is half of the number of global users. In contrast to earlier revolutions, the Internet exercises global influence and it will build upon this precedent, inasmuch as it continues to change business, political and cultural communication. There has been as good as no public debate over the potential and future direction of digital architecture; one hears even less about the possible effects on the form of our buildings. Although eloquent critics like William Mitchell have courageously tried to analyse this phenomenon, there is still a lack of explanations which outline a coherent vision of the current radical changes taking place in our built-up environment.<sup>23</sup> This radical change in the concept of architecture is happening in the area of architectural space, that intangible principle medium so familiar to the architect, the careful, creative formation of which so differentiates his work from that of the construction-engineer. The computer has brought along with this a fundamental reassessment of space and time, where the change from a pre-industrial state to the above mentioned cyberspace has occurred in around a hundred years.

As an example, Behnisch's architectural-office in Stuttgart represents one extreme position, in which it defines the computer as merely an aid in traditional design-planning.

---

<sup>22</sup> LA Times, Oct.17, 1995

<sup>23</sup> James Steele, *Architektur und Computer – Planung und Konstruktion im digitalen Zeitalter*, Verlag Callway, München, 2001, p.8



Fig.8 NOX architects, Beachness, Noordwijk



Fig.9 Günter Behnisch, Theatre- and Concert-Hall, Bristol, 1998

Behnisch argues that his office normally works with standard architectural models and thus only uses AutoCAD for routine tasks, such as the drawing of plans and the compilation of technical studies. This leads to clearly distinguishable patterns of repetition in conceptualisation, in contrast to individual designs created using a computer, such as NOX's Beachness Project in Fig.8.<sup>24</sup>

Behnisch's office won a bid for a theatre- and concert-hall in Bristol harbour in 1996. The design illustrates well Behnisch's credo. Here, too, we can easily see limitations in the design. It is made clear how important real models were for the building's shape, which were then checked and revised with the help of appropriate software, in this case regarding the acoustics of the concert hall.

Frank Gehry presents various ways of using digital tools to achieve design goals. The physical model precedes the virtual model for him. When designing L.A.'s Disney Concert Hall, models were built, laser-scanned, and brought into CATIA software for analysis and refinement of the design. In particular, the stone cladding for the Concert Hall was developed with computers, using CATIA both for design and cost control.<sup>25</sup>

Fig.10 Frank Gehry, View (left) and the digitized plan (right) of the curved surfaces based on the computer controlled milling in the Disney Concert Hall, L.A., 2003

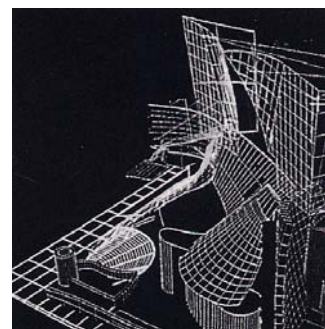

The project benefited from greater acceptance of computing in design when it was restarted, post-Bilbao, in 1997 and

<sup>24</sup> Ibid., p.73

<sup>25</sup> Annette LeCuyer, Designs on the computer in ARCH+, September 1995, p.80

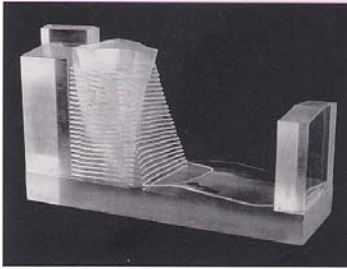

Fig.11 Peter Eisenman, Glass model of "Haus Immendorff", 1993

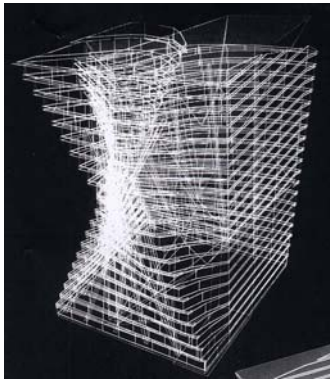

Fig.12 Peter Eisenman, Computer drawing of wire frame



Fig.13 Peter Eisenman, Computer study of building skin

finished in 2003. The Concert Hall, with its demanding seismic and acoustical requirements, is so complex that a 4D-CAD visualization tool was developed by Disney and Stanford University to show its erection sequence over time. Gehry used the 4D model to identify and correct construction problems before they occurred.

While the use of the computer by Gehry is primarily concerned with surfaces, Peter Eisenman uses the computer to explore more dynamic, unpredictable system of organization.

He uses Form Z Macintosh software to generate natural phenomena such as waves, quasi-crystals and slime moulds, all of which, in his terms, have no a priori knowledge or contingencies.<sup>26</sup> As shown in Fig.11, the starting point of his project "Haus Immendorff" in Düsseldorf, Germany, is a cube deformed by solution waves<sup>27</sup>, a dynamic system bordering on chaos. For Eisenman, the solution analogy for the deformation of the cube has produced outer and inner volumes whose surfaces intersect as they twist vertically, forming a vortex-like cone of space. The form could not have been foreseen but was discovered only through the use of a computer. The use of AutoCAD and Form-Z creates inner and outer volumes which are formed by the non-linear interaction of solitary waves twisting vertically, as shown in Fig.13.

William J. Mitchell is exploring design tools with unique interfaces; one of the most intriguing is called Illuminating Clay, which lets designers analyze free form clay models. The model's geometry is captured in real time with a laser scanner; using this information, computer simulations of conditions such as shadow casting, land erosion, or visibility

<sup>26</sup> Ibid., p.p.80-81

<sup>27</sup> Solitary waves are physical phenomena that occur seemingly at random, but are caused by measurable physical factors such as abrupt changes in depth or subterranean seismic patterns in water.

Fig.14 William J. Mitchell, Illuminating Clay

are calculated and projected back onto the clay model.<sup>28</sup>

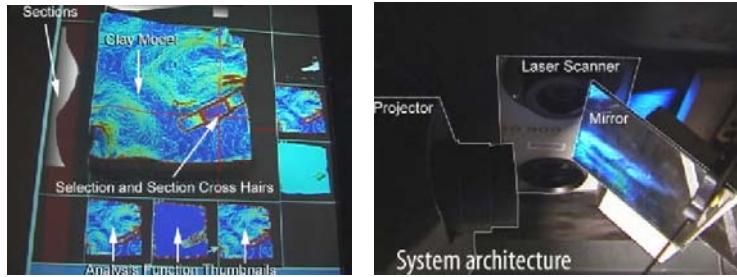

Mark Burry has been involved in completing the construction of Antonio Gaudi's Sagrada Familia Cathedral in Barcelona since the 1970s. Construction began on the church in 1889, but it was unfinished when Gaudi died in 1926. The design's documentation was incomplete, because many of the 1:10 scale plaster models he left behind were destroyed in the 1930s. Burry has taken photos, drawings, and surviving shards of the models and analyzed them with parametric design software to fill in the missing gaps. The software was essential for resolving the complex geometries that Gaudi had conceived. The left-hand picture in Fig.15 illustrates a column from the Cathedral. Computer modelling illustrates the development of a single eight-sided column, as shown in the right-hand picture in Fig.15:

Fig.15 Real columns and computer modelling of columns in the St. Familia Cathedral

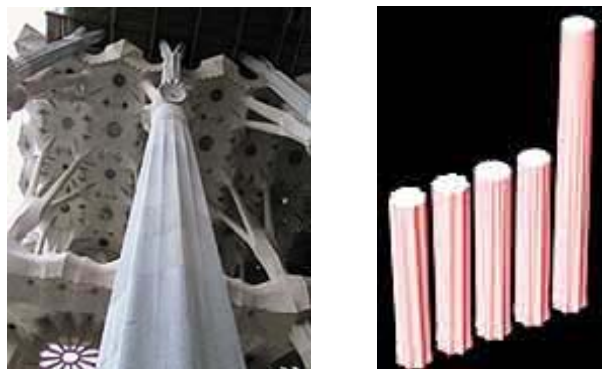

Fig.16 Nicholas Grimshaw, View of the Biomes, 1998

In Nicholas Grimshaw's giant bubble-like Biomes of the Eden Project in Cornwall, England, the main focus is on the geodesic domes, which Buckminster Fuller and Frei Otto had earlier developed, as shown in Fig.17 and 18.

<sup>28</sup> See the <http://www.descomp.mit.edu> (2003) for further information.





Fig.17 Buckminster Fuller, Union Tank Car Dome at Baton Rouge, Louisiana, 1959



Fig.18 Frei Otto, Roof structure of a baths-facility in Borkum, 1966

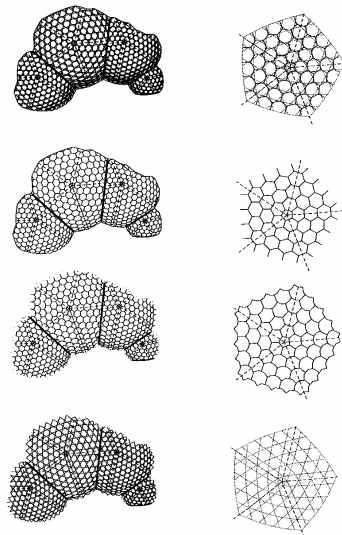

Fig.19 Nicholas Grimshaw, Analysis of structure of biomes using a computer

The great advantage of these is that the load is transferred to the ground not in the point-forming way, as is normal in such construction, but in the line-forming way. In this case, specially developed computer programmes were needed to optimize the geometry of the steel grid shells so that a consistent flow of forces could be guaranteed at all points on the grid. Here, 3-D programmes and finite element software not only make it possible to examine the way the load-bearing structure works and optimize this, but also establish dimensions for the individual components and carry out non-linear calculations. In the same way, the building's stability under different stresses can be simulated, and thus predicted, by using computer programmes of this kind. Tension and distortion diagrams using different colours for different forces also use the computer monitor to illustrate the characteristics of the structure.

There is a tendency in contemporary architecture, as can be seen above, to aid architectural designs, regarding form-making, structural- and acoustic-analysis and problem-solving with the help of multimedia, such as various computer-graphics and CAD-software. Generally, the advantages of computer-aided designs are the following:

- *The computer has made possible new modes of expression.*
- *With a computer, one can exploit to the maximum the potential of virtual space.*
- *Use of the computer has undoubtedly shortened planning-phases. Thus, building-costs can be reduced.*
- *New design ideas can be explored directly by manipulating three-dimensional objects or spaces, without translating them into two-dimensional drawings.*
- *Designs can be developed as a collaborative work, sharing design information and exchanging comments through networks, which has become quite an important*



*process in a practical world.*<sup>29</sup>

- *An increased number of design alternatives can be generated.*

All the uses of computers in architecture can not be described here, since these uses are quite varied and then differ according to the goal of a design. In the above mentioned cases, specific types of computer-use can be summarized in the following table:

Table 2 Types of computer-use in architecture

Types of computer-use	Architect
Conceptual initial, exploration of more dynamic and unpredictable forms	Peter Eisenman
Transformation of an idea into physical reality for achieving design goal	Frank Gehry
Standard tool which has replaced traditional design planning, tool for acoustic effects	Günter Behnisch
Analysis of free form clay models	William J. Mitchell
Analysis of existing objects and exploration of objects involved	Mark Burry
Structural analysis	Nicholas Grimshaw

---

<sup>29</sup> Detailed content of this will be discussed in Chapter 4.

---

## 2.3 Development of CAD and CAAD

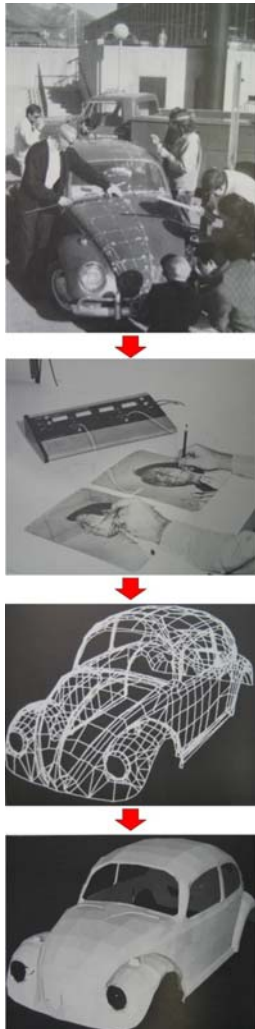

Fig.20 Process of a car modelling with SKETCHPAD

The first CAD (Computer-Aided Drafting or Design) tools were developed and used in the field of engineering, such as mechanical engineering or aerospace engineering. In 1960, Ivan Sutherland used the TX-2 computer developed at MIT's Lincoln Laboratory to produce a project called "SKETCHPAD", which is now considered as having been the first step towards the CAD industry. The concept of "SKETCHPAD", though written about forty years ago, which has been applied to many techniques, is still important today.<sup>30</sup> It allowed an engineer to generate designs by sitting at an interactive graphics terminal, and manipulating objects displayed on the screen by use of a light-pen and a keyboard. The presentation of SKETCHPAD at the 1963 Spring Joint Computer Conference, and showings of a film on the system generated interest among many engineers in the potentials of computer-aided design.<sup>31</sup>

In the late 1960s, some of the architects saw the importance and the necessity of these tools for their work. However, these tools were not directed at the needs of designers and architects. They were isolated from architectural practice.

In the 1970s, CAD was an electronic version of the drawing board and mostly 2D-orientated. This tool used simple algorithms to display patterns of lines in two dimensions. As the need for and the use of CAD have gradually grown, CAD tools have developed for architects and designers since 1980.<sup>32</sup> In Germany between 1982 and 1983, it played an important role in both construction firms and design studios. There was a CAD-model called "2½D", which generally referred to the modelling of surfaces through x, y, and other attribute values.

---

<sup>30</sup> J.A.N. Lee, International Biographical Dictionary of Computer Pioneers, Fitzroy Dearborn Publishers, London, 1995, p.653

<sup>31</sup> William J. Mitchell, Computer-Aided Architectural Design, Van Nostrand Reinhold Company, New York, 1977, p.p.14-15

<sup>32</sup> Sevil Sariyildiz, Improving CAAD by Applying Integrated Design Support Systems and New Design Methodologies in CAAD futures 1997, Kluwer Academic Publishers, Dordrecht, 1997, p.152

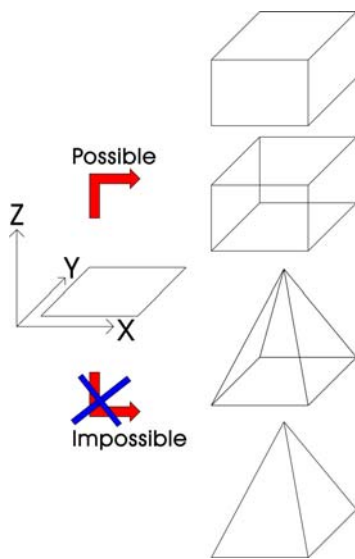

Fig.21 Volume of extrusion in the 2½D-system

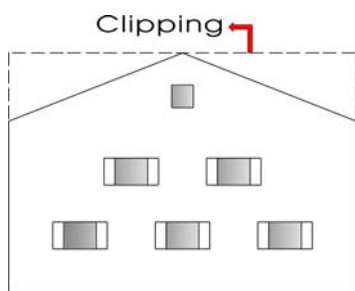

Fig.22 Clipping in the 2½D-system

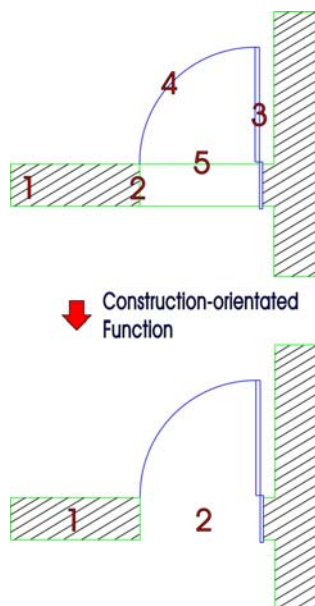

Fig.23 New function for construction

As shown in Fig.21, the 2½D offered users the opportunity of drawing their geometric objects simply, but only those with right-angles, so that this system could not provide free surfaces for forms, as most three dimensional objects are created by “volume of extrusion” or “sweep geometry” in this system; only simple geometry could be drawn. However, relatively complex shapes could be created through “clipping”, as shown in Fig.22.

In the mid 1980s, the first three CAD systems that were orientated to architects’ professions, such as RIBCON of RIB GmbH, SPEEDIKON of IEZ AG and Bott-Bauset of BOTT, began to lead to the systematic application of computing for the German building industry; Fig.23 illustrates a new function concept for construction when designing a door. In those days, the high-tech calculating machine was the IBM 1620 (capability 12.6Kb) which cost about 1.2 million DM (Deutsche Mark/German marks)<sup>33</sup>, and the HP 9845 computer which was one of the largest of HP’s 98xx series. In particular, CAAD was rapidly developed for the ACE industry and reached a new level of quality. The respective meanings of CAD and CAAD became differentiated. Both terms “CAD” and “CAAD” differ by one letter “A”, which stands for “architectural”.

CAD = CA (Computer Aided)-Drafting or CA-Design

CAAD = CA (Computer Aided) Architectural Design

Traditional CAD was and is the assistant to a draftsman. However, CAAD plays a significant role as a tool for solving design problems in architecture or for deriving a new architectural solution. This means that CAD and CAAD are different activities; in other words, the word “architectural” in CAAD denotes something intelligent and special, not only the sum of lines or volume in CAD. Nowadays, there are CAAD systems valuable which are suitable for various building

<sup>33</sup> <http://www.rib.de/unternehmen/historie/> (2003)



Fig.24 IBM 1620



Fig.25 HP 9845

performance calculations and evaluation tools. Presentation has also been dramatically improved. For example, wire frames and flat-shaded images are replaced by very realistic, interactive, virtual-reality models giving both clients as well as designers a much better understanding of the consequences of design decisions.

Through the dazzling development of CAD systems between the 1980s and 1990s, current CAD systems, such as Allplan, ArchiCAD, AutoCAD/Architectural Desktop and MicroStation, are not only building element based, but also offer the IFC<sup>34</sup> exchange capability.

Along with the development of CAD, CAAD was introduced in the 1950s to assist designers in assessing the optimisation of their creations. It was and is a process in which architectural designs are created using a computer. The process of designing buildings continues to use habitual, manual methods, but at certain points along the design process quantities are measured manually and fed into computer programs that can analyse them. The results are then applied manually to the evolving design.<sup>35</sup> An attempt at evolving a design in CAAD can be largely divided into two categories. One defines grammar rules about how design has to be and creates one or even a hundred solutions to choose from.<sup>36</sup> Another approach is the analysis of existing designs to derive new solutions similar to the ones in the data base.<sup>37</sup> This research proves that the emphasis in CAAD has shifted from developing better engineering analysis programmes to finding modes for bringing the emerging design solution to the

<sup>34</sup> The concrete details about IFC are described in Chapter 4.

<sup>35</sup> See M.J.Mitchell's article "Computer-aided architectural design", Van Nostrand Reinhold, New York, 1977

<sup>36</sup> See Shih S.G. and G.Schmitt's article "The Use of Postinterpretation for Grammar-Based Generative Systems" in Proceedings, International Workshop on Formal Design Methods for CAD, 1993

<sup>37</sup> See U.Flemming's article "Case-based design in the SEED system" in Knowledge-Based Computer-Aided Architectural Design, 1994

computer; computational representation of buildings now takes centre stage. The latest CAAD systems are based on product modelling concepts using object-orientated techniques.

---

## **2.4 Increasing Demand for Traditional Architectural Theories in Design and Construction**

The building-industry is suffering from the high total-costs of its structurally non-dimensional products, which are relatively minimally automated, computer-aided and, now as before, highly manual-labour orientated; these are wage-intensive products. Efforts to improve architectural design and simultaneously to reduce building and completion costs through comprehensive mechanical and computational technology have met with little success in the past, as has been the case in other branches of the economy.

Construction using computerised design-programmes has great advantages in the two branches of design and construction in architecture. In the design aspect, the computational programmes such as multimedia not only empower our imagination, but also provide opportunities for verisimilitude to support decision-making and for shortening planning-phases.

In the construction aspect, this also has a lot of advantages, such as shorter building-time, greater precision (higher security standards for walls, greater strength in concrete), continuous machine capacity, resistance to the weather, dry construction-sites, the solving of complex details and surface cleaning by stationary saw- and planning-apparatus.

Along with this a problem arises: new elements in mechanically-prepared construction often appear unformed, due to soulless machinery. In other words, building, too, should meet aesthetic expectations. Technology-guided

construction has so far been unable to do justice to customers' needs concerning flexibility and appropriate aesthetic form.

The main problem lies in its lack of product variety and inadequate observation of formal aesthetics, which is caused by the use of rigid, inflexible shaping-tools. Due to its flexibility and technological potential, a useful computational tool today can bring about a turnaround in formal restrictions imposed by these rigid shaping-tools.

A new traditional fundamental of architecture, incorporating CAAD programmes, could find its place among the new methods of production-technology used by the construction industry and so help to bridge the gap between itself and the values of traditional architecture and its famous teachers, such as Pythagoras, Vitruvius, Leon Battista Alberti, Andrea Palladio, August Thiersch, Paul Renner, Le Corbusier, etc.

## 3. CHAPTER

# Analysis of Design and Ordering Principles of Architecture

---

### 3.1 Design Control using the Ordering System of Architecture

Throughout the history of architecture, there has been a quest for an ordering system that facilitates the technical and aesthetic requirements of a design. Such a system would have to ensure repetition of a few key ratios throughout the design, have additional properties that would enable the whole to equal the sum of its parts, and be computationally applicable; in other words, to be adaptable to the architect's technical means. Architecture consists of various elements. The relationship between these elements is regulated in a specific way; that is, by the ordering system of architecture. This system can be very simple and clear, but also complex. Max Bense, who is the founder of "Information Aesthetics", divided orders in a design into three categories: chaos, structure and gestalt.<sup>38</sup> According to his theory, total chaos arises where there is not any observed order that governs the relationship between the elements. The perception of structure is concerned with a regular order. Structural framework plays an important role when recognizing regular forms.

As Max Bense argued, the role of some orders is of importance in a design. The order of the elements is subject

---

<sup>38</sup> Max Bense, Einführung in die informationstheoretische Ästhetik – Grundlegung und Anwendung in der Texttheorie, Rowohlt Taschenbuch Verlag, Reinbeck bei Hamburg, 1969, p.36

to a fundamental rule: the more the degree of arrangement increases and the more complex it becomes, the more the information content reaching the eyes decreases. This basic rule comes from the aesthetic knowledge of former generations of architects, because they always attempted to create conscious beauty in their architectural works with the aid of this arrangement. For example, previous architects strove to achieve the appropriate balance between arrangement and chaos in designing a building, applying this basic knowledge. In order to satisfy human expectations, the functionality and the construction of a building are alone not often sufficient, along with these aesthetic expectations should be met, such as an arrangement of openings in a façade or optimal dimension of a building- and courtyard-size.<sup>39</sup> The specific ordering-system can help to avoid chaos in a design. This basic ordering system is as follows:

- *Axes and Grids*
- *Symmetry and Proportion*
- *Rhythm and Balance*

---

### 3.1.1 Axes and Grids

---

#### 3.1.1.1 Axes

The use of axes is the most elementary means of organizing forms and spaces in architecture.<sup>40</sup> The imposition of a major and a minor axis on a plan is a natural corollary to imposing three dimensions on objects in a space, in order to facilitate our perception of form.

As shown in Fig.26, the floor-plan of the Parthenon is the best

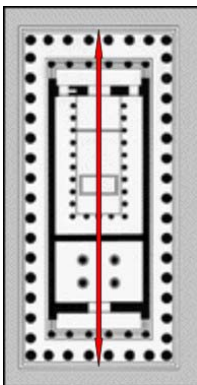

Fig.26 Axis of Parthenon, Athens, Greece

---

<sup>39</sup> Rudolf Wienands, *Grundlagen der Gestaltung zu Bau und Stadtbau*, Birkhäuser, Basel, 1985, p.105

<sup>40</sup> Francis D.K.Ching, *Architecture: Form, Space & Order*, Van Nostrand Reinhold Company, New York, 1979, p.334



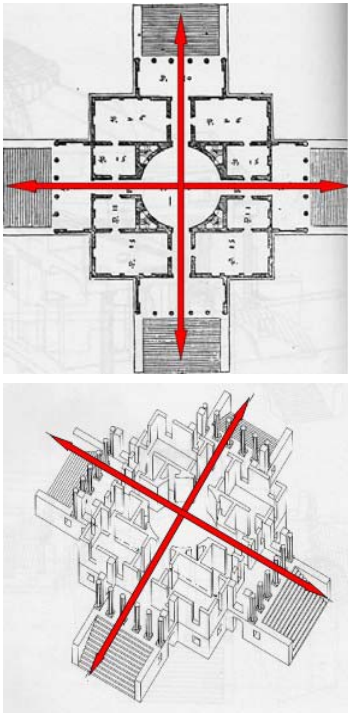

Fig.27 Axes of Villa Rotonda, Palladio

example of a floor plan based on a single axis, as the use of an axis is a method for ordering the complex functions of a building and directing the movement of a person through those spaces. Spaces or forms are placed either along the line or on either side of the line. Often, the forms on one side are equally balanced in size or shape by the forms on the other side, resulting in a symmetrical plan.

Fig.27 shows architectural axes of Palladio's Villa Rotonda, which establish a symmetrical arrangement of forms and spaces.

For Juan Guadet at the beginning of the century, "symmetrical disposition about axes was unquestioned", and Le Corbusier stated clearly that "The axis is the regulator of architecture . . . architecture is based on axes".<sup>41</sup> In short, an axis plays an important role in the dimensional arrangement of elements in an architectural design; that is, it plays a basic role as an ordering system of architecture. Additionally, it helps to avoid arbitrary positioning and produces an ordered relationship between scattered elements. At this point, it must be noted that the more symmetrical the components of a plan are, the simpler the axis should be that is placed in this plan<sup>42</sup>, in order to achieve unity within the plan. We should also remember that axis, the symmetrical layout of the elements of a building, is not merely an overall aesthetic principle, but also a sound structural one.<sup>43</sup>

---

### 3.1.1.2 Grids

One of the oldest tools for creating order is the grid. Working

---

<sup>41</sup> David Smith Capon, *Architectural Theory Volume Two – Le Corbusier's Legacy*, John Wiley&Sons, Chichester, 1999, p.p.54-55

<sup>42</sup> Rudolf Wienands, *op.cit.*, p.106

<sup>43</sup> Jürgen Joedicke, *Raum und Form in der Architektur – Über den behutsamen Umgang mit der Vergangenheit*, Karl Krämer Verlag, Stuttgart, 1985, p.46

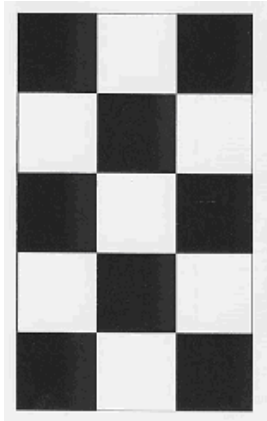

Fig.28 Grid of chessboard

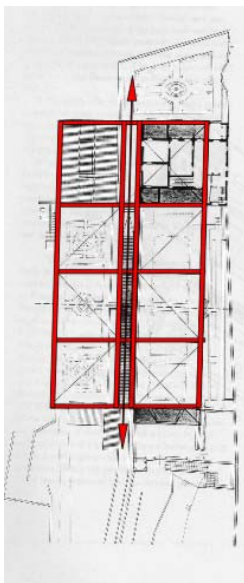

Fig.29 Grid in the Villa Medici

with the grid has been criticised by a lot of architects. It produces results that are stifling, rigid and non-creative. However, the grid can produce interesting images and compositions if used in a sophisticated manner. As shown in Fig.28, the chessboard is probably the best example of a grid. Though essentially a repetitive and monotonous pattern, the alternating black and white units increase visual interest.

Any composition can be analysed diagrammatically, using a grid structure. This will help in defining the actual subject of the composition, while simultaneously identifying the other elements complementing it, and will also help in understanding the relative positions of the various elements and objects. Thus, our eyes are drawn to the thing nearest to us in the composition and travel down to the one farthest from us. The zones of interest in the composition are also easily distinguished.

A grid determines the orientation of a plan, in a geometric and ordered manner. It is most often repetitive and gives regular intervals to the organization of the floor plan of a piece of architecture, as shown in Fig.29. The vertical and horizontal grid lines can change direction, assuming any angle, to create a more dynamic directional grid, which can be further divided to form the more complex triangular grid.

Variations on a simple grid tend to make compositions more dynamic, since pure repetition tends to become monotonous. The squares in a simple grid can be divided into smaller, more complex areas - however, even these smaller shapes must be equal in size and shape. A shift- or drop-grid is achieved by shifting alternate rows of a simple grid - up or down, or from side to side, usually by a uniform distance, although the rows may also be shifted non-uniformly. As an example, Tschumi used a grid to govern the composition of his entire complex park design "La Villet".

Fig.30 Folie-plan in La Villet, Paris

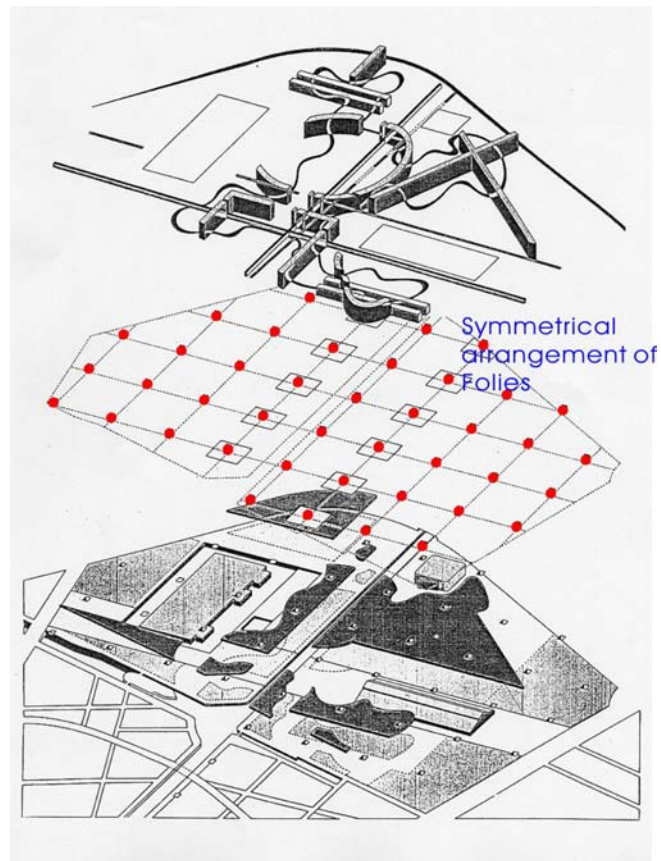

---

### 3.1.2 Symmetry and Proportion

---

#### 3.1.2.1 Symmetry

Ordered designs are frequently encountered in art and architecture. The underlying structure of their spatial logic may be analysed with regard to the use of symmetrical principles. In some architectural designs, the use of symmetry may be apparent immediately by merely looking at designs, although the final design is seemingly asymmetrical; or various symmetries are manifested in the different parts of a design, yet not immediately recognizable despite an almost obsessive concern for symmetry. We are all aware that classical architecture was dominated by symmetry.

Furthermore, the concept of symmetry underwent a rapid evolution during the Renaissance. Symmetry's original meaning was closer to the concept of commensuration or correspondence in measurement, and related more to proportion than to the modern concept of symmetry. Vitruvius often employed this term along with the concept of proportion, as in the phrase "symmetrical proportions". When symmetry took on its current meaning "the word's ancient association with "beautiful" probably strengthened the idea that a design with two identical halves was more beautiful than one without".<sup>44</sup>

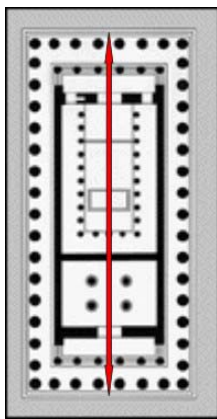

Fig.31 Symmetrical plan of Parthenon

As shown in Fig.31, the plan of the Parthenon is a good example of symmetry because it demonstrates correspondence in size, shape and position of parts on opposite sides of a dividing line or axis.

There are basically two types of symmetry: bilateral- and radial-symmetry. Bilateral symmetry refers to the balancing and arrangement of equivalent elements about a common axis. Radial symmetry consists of equivalent elements balanced about two or more axes that intersect at a central point.<sup>45</sup>

Using this method of giving form, in other words the flexible placing of rigidly symmetrical parts worked out to the last detail, achieves a maximum of utility and functionality, specifically through the interchangeability and replace ability of the parts. A sole element can be completely dispensed with, altered or reconstructed without disturbing the integrity of the whole.

In short, symmetry is the correspondence in size, shape and position of parts on opposite sides of a dividing line or axis. If a line is drawn across the axis, either in plan or in elevation, one half of the building can be reproduced as a mirror image of the other half. Use of symmetry is one method for creating

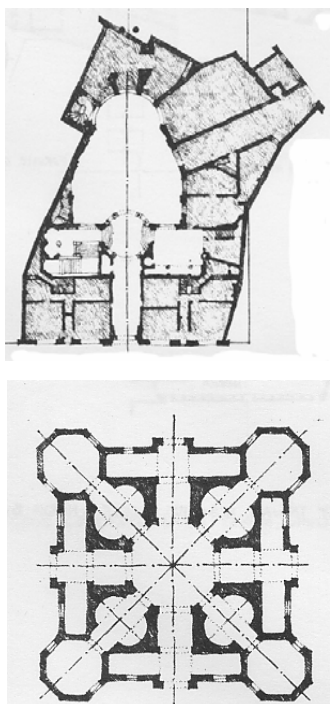

Fig.32 Example of bilateral- (above) and radial-symmetry (bottom)

<sup>44</sup> Stephen R. Wassell, *The Mathematics of Palladio's Villas*, NEXUS II - Architecture and Mathematics, Edizioni Dell'erba, Italy, 1999, p.183

<sup>45</sup> Francis D.K.Ching, *op.cit.*, p.342

a sense of balance.

---

### 3.1.2.2 Proportion

The term “proportion” is defined as “the equality of two ratios”. It also refers to “the relation of one part to another or to the whole”. For example, a room that is three meters wide by four meters long has a ratio of 3 to 4.

In his book “The Theory of Proportion in Architecture”, P.H.Scholfield discusses three systems of architectural proportion that meet the following requirements: the system of musical proportions used during the Renaissance developed by Leon Battista Alberti, another system used during Roman times, and the “Modulor” of the twentieth-century architect, Le Corbusier. Along with these, we will describe Van der Laan’s proportional system, “The Plastic Number”. Of these, the first two were already known, in principle, to the ancient Greeks, while the last two are relatively modern ideas.

#### ① Ancient Greek and Roman proportional systems

Ancient Greek proportional systems were characterized by mathematical ratios, but were then carefully adjusted to compensate for optical illusions. Pythagoras discovered that the consonance of the Greek musical system could be expressed by the simple numerical progression, 1:2:3:4, and their ratios, 1:2, 1:3, 2:3, 3:4. Furthermore, another Pythagorean expounded the theory of proportion – the three means: arithmetic, geometric, and harmonic.<sup>46</sup> Plato was more Pythagorean than Pythagoras, for the conviction that nature is precisely ordered to a mathematical rationale was

---

<sup>46</sup> The arithmetic mean is the middle term between two others that exceeds the one term by as much as it is itself exceeded by the other. The geometric mean is the middle term between two others that has the same ratio to the one term as the other has to itself. The harmonic mean is the middle term between two others that exceeds the one term and is exceeded by the other by the same proportion of each term.

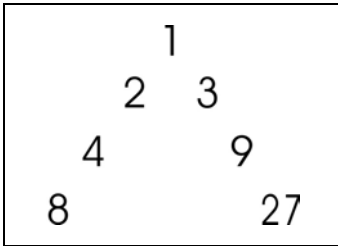

Fig.33 Number series in Timaeus

given greater significance by the Platonic belief in the supreme power of human intelligence. The “Timaeus” in his book is a formal embodiment of much of the Pythagorean/Platonic number-cosmology.

To describe the material and structure of the harmony of the numbers 1, 2, 3, 4, 9, 8, and 27, which is the combination of the squares and cubes of the double and triple proportions, we start from unity, that is, the two geometrical progressions 1, 2, 4, 8, and 1, 3, 9, 27. These numbers, often drawn in the Lambda arrangement, contain in their ratios all the actual musical consonances as well as the divine harmony of proportion. This relationship led the Greeks to believe that they had found the key to the mysterious harmony that pervaded the universe.

The other characteristic of the Greek proportional system is the use of the module. The dimensions of a Greek temple are based on the radius of its module. Hence, one could construct an entire temple based on one part and the ratio.

The use of a module was a common dimensional measurement used to design a building in those days. Vitruvius also explained its use<sup>47</sup>: he insisted that symmetry may be calculated from the thickness of a column, from a triglyph, or even from a module, in the case of temples. A.M. Bulckens analysed the Parthenon according to a module and found that the size of its module is equal to the width of a triglyph, and the width of a metope is 1.5 times the width of a triglyph.<sup>48</sup>

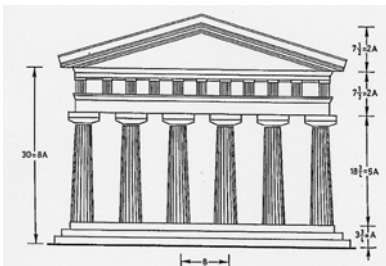
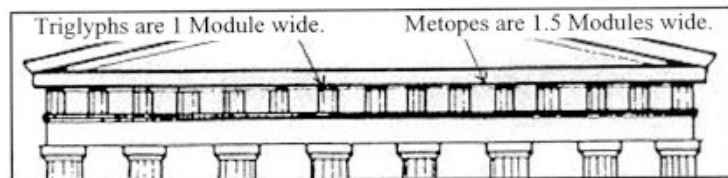

Fig.34 Module of Parthenon

Fig.35 Triglyphs and Metopes



<sup>47</sup> P.H.Scholfield. op.cit., p.24

<sup>48</sup> See A.M.Bulckens’ “The Parthenon’s Symmetry”, ISIS-Symmetry, Sydney, 2001

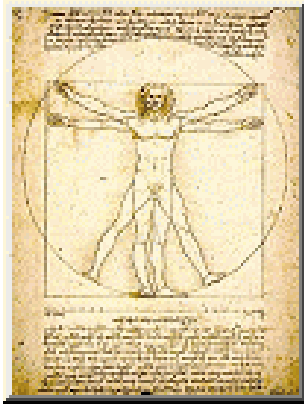

Fig.36 Human proportion, Leonardo da Vinci,

### ② Renaissance proportional systems

Renaissance ideals in art and architecture included order, unity, harmony of proportion, clarity, simplicity, balance and symmetry. Using these principles, Renaissance building became somewhat lighter and more graceful than previous architectural constructions. In particular, proportional systems were used to imitate, though with some exceptions, the ancient Greek approach in the Renaissance. The main source of the Renaissance theory of proportion was Vitruvius<sup>49</sup> and the proportions used by Renaissance architects were musical proportion, golden proportion and proportion of the human figure. For instance, Leonardo da Vinci offered intensely detailed descriptions of the human form, proposing new interrelationships between the circle, square and human body. During this period, the golden proportion was understood to a much greater extent than before, due to the work of Fibonacci and musical proportion was pervaded by the fact that from the beginning Alberti himself expounded musical theory in architecture.

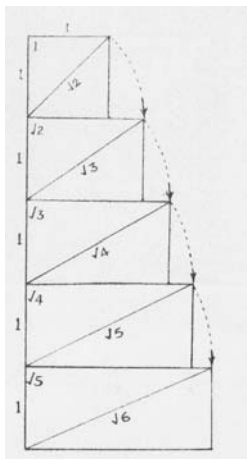

Fig.37 Square root proportion

### ③ Square root proportional systems

Root proportions, which each possess their own individual characteristics, are best explained first in diagrammatic form. Fig.37 shows the simple geometric generation of root rectangles ( $\sqrt{2}=1.4142$ ,  $\sqrt{3}=1.732$ ,  $\sqrt{4}$ , and  $\sqrt{5}=2.236$ ) from the original unity of the square.

In particular, the use of the  $\sqrt{2}$  rectangle is very common in architectural proportion. It turns up from time to time in the Renaissance. Palladio included the  $\sqrt{2}$  rectangle in the list of seven shapes which he recommended for the plans of rooms.<sup>50</sup> He showed seven examples of vaulted rooms, with as plan-shapes the circle, the square, the square-and-a-half, the square-and-a-third, the square-and-two-thirds, the double square, and finally a  $\sqrt{2}$  rectangle with its length equal to the

<sup>49</sup> P.H.Scholfield, op.cit., p.34

<sup>50</sup> Ibid., p.50



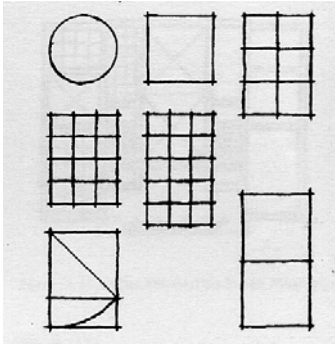

Fig.38 Andrea Palladio,  
Recommended plan-shapes  
for rooms

$0.318:0.618 = 0.618:1.0$ $0.236:0.318 = 0.318:0.618$ $0.145:0.236 = 0.236:0.381$ etc.
--

Fig.39 Ratios of Golden Section

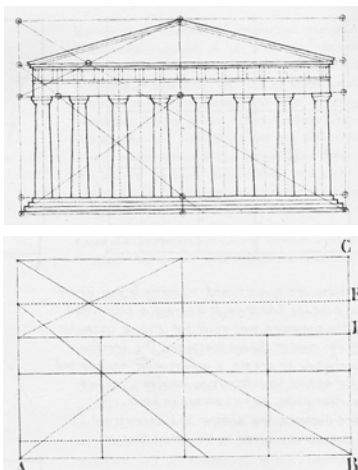

Fig.40 Golden proportion in the  
façade of Parthenon

diagonal of the square on its shorter side.<sup>51</sup>

This occurrence of the  $\sqrt{2}$  rectangle has been discussed by various theorists in different ways. Legh tried to explain the occurrence of the square root of two in Vitruvius as an approximation to the simple ratio 7:5. However, Professor Wittkower suggested that “it is probably true to say that neither Palladio nor any other Renaissance architect ever, in practice, used irrational proportion”.<sup>52</sup>

#### ④ Golden proportion system

The charm of the golden proportion, also called the Divine Proportion, is that the ratio of the smaller part to the larger part is equivalent to the ratio of the larger part to the whole, for example,  $0.318:0.618 = 0.618:1.0$

It has some remarkable algebraic and geometric properties that account for its existence in architecture. Because the relationship of the golden proportion is maintained in the ratio of the smaller to larger sections, it is possible to establish a continuing golden proportion by taking the larger section of each proportion and letting that be the next proportion, as in the ratios on the left.

The beauty of the golden proportion can be best appreciated by the fact that its rectangle subdivides into a square and another, smaller golden proportion rectangle. This process can be continued ad infinitum and similarly inversed by adding a square over the longer side of a golden proportion rectangle, thus establishing a proportional relationship over the entire imaginable scale of human artifacts.

Fig.40 illustrates the use of the golden proportion for the façade of the Parthenon. It is interesting to note that while this analysis begins by fitting the façade into a golden rectangle; each rectangle, which is created according to the golden

<sup>51</sup> Richard Padovan, op.cit., p.233

<sup>52</sup> P.H.Scholfield, op.cit., p.51



proportion, affects the façade's dimensions and distribution of elements:  $AB:BC :: BC:BD :: BD:CD :: CD:CE = 0.618$

Although the golden proportion is nowadays the most popular key to good proportion, it is seldom that any attempt is made to compare its merits with those of its rivals. Why? It may be possible to give the reason for this as the fact that architects experience inconvenience when using the golden proportion in their designs. It may also be not easy to apply it to the design by hand, using a calculator or existing CAD system used only as a drawing tool. However, if a CAAD system existed which could help to apply the golden proportion to the design easily, the above mentioned limitation would be removed. Its application will be described in Chapter 5.

#### ⑤ Musical proportion

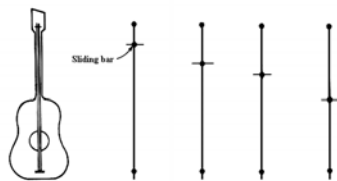

Fig.41 Divisions for the relationship showing musical proportions

In the western world, some of the earliest known reflections on music are those of the Pythagoreans, which date to the sixth century B.C. Music was defined in terms of ratios – the science of relative numbers or numbers in ratio.<sup>53</sup> For a Pythagorean, the blending of two musical tones into a harmony, known as the Perfect Fifth, is a manifestation of the harmonious blending of two qualities of number, 2:3. In this sense, the term “ratio” refers to a harmony that relates to the various melodic and harmonic relationships by which tones fit together.<sup>54</sup> As shown in Fig.41, a sliding bridge on a monochord divides the string length representing the fundamental tone into segments corresponding to musical fifth (2:3), fourth (3:4) and octave (1:2).

In that these relationships are directly determined by numeral ratio, it is proper to begin with an analysis of how musical harmony can be applied to architecture. As a survey of architectural history shows, there was a long tradition of

<sup>53</sup> Allen A. Dorfman, A theory of form and proportion in music, University of California, Los Angeles, 1986, p.26

<sup>54</sup> Edward A. Lippman, Musical thought in ancient Greece, Columbia University Press, New York and London, 1964, p.p.1-3

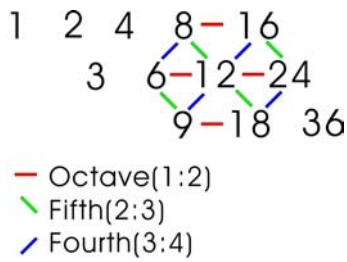
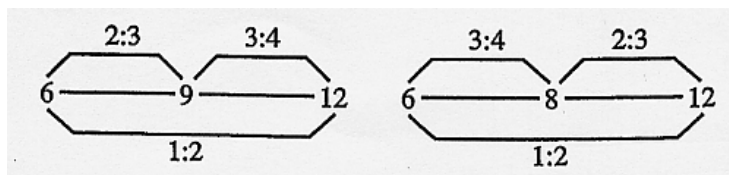

Fig.42 Integer series of musical proportion

combining architecture and music. For instance, as mentioned above, the foundation of the Greek musical system was expressed by the progression 1, 2, 3, 4, .... In the opinion of Plato, the basis of harmony and the cosmos are the progressions: 1, 2, 4, 8 and 1, 3, 9, 27. Additional integer series made up of the arithmetic means of adjacent numbers can be described as in the following Fig.42.

These integer series show that the ratio of successive terms in the horizontal direction is in the octave ratio, while the left-leaning diagonal represents the musical fifth ratio and the right-leaning diagonal exhibits the musical fourth ratio. As a result of these relationships, any sequence that includes the arithmetic and harmonic means of its endpoints ensures a repetition of ratio as illustrated by the sequence 6, 8, 9, 12.

Fig.43 Musical consonance between the sequences 6, 8, 9, 12



Alberti and Brunelleschi designed buildings on the basis of proportional relations derived from these musical harmonics. During the Italian Renaissance, especially, Alberti and Palladio developed a system of architectural proportion based on proportions inherent in the musical scale. Alberti compiled a list of the ratios between the lengths and sides of rooms. These consist of the ratios 1:1, 2:3 and 3:4 for short rooms, 2:1, 4:9 and 9:16 for medium rooms, and 3:1, 3:8 and 4:1 for long rooms. The following Table 3 gives the musical intervals to which these ratios correspond:

Table 3 Alberti's recommended proportions for each area

Ratio	Musical Interval	Diagram			Areas
1:1	Unison	1:1	4:3	3:2	Short rooms
4:3	Fourth				
3:2	Fifth				
16:9	Octave	16:9	2:1	9:4	Medium rooms
2:1					
9:4					
8:3	Eleventh	8:3	3:1	4:1	Long rooms
3:1	Twelfth				
4:1	Fifteenth				

All of the ratios correspond to musical consonances except two, 16:9 and 9:4, which are equal respectively to  $(4:3)^2$  and  $(3:2)^2$ . Fig.44 proves that Palladio used musical ratios in the proportioning of his buildings. Each proportion used in the floor plan of Villa Malcontenta corresponds to those proportions that Alberti proposed.

Fig.44 Floor-plan and analysis of proportion system in Villa Malcontenta

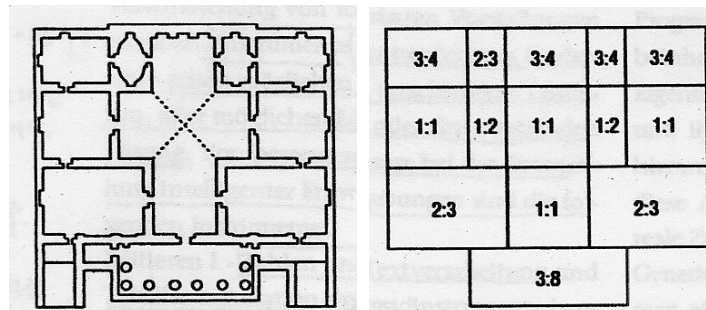

This musical theory of architectural proportion seems to have originated in the sixteenth century, and has continued up to

the present day.<sup>55</sup>

One of the most dominant proportions used by Renaissance architects was the musical theory of proportion, which Professor Wittkower dealt with and which Alberti himself had originated.<sup>56</sup> The musical analogy starts with the fact that groups of notes in music produced, for instance, by strings whose lengths are simply commensurable please the ears. It has been discussed as “the value of musical proportion in architecture”. Perrault was attracted to this theory by the fact that the ear is not able to pass on to the mind any information about mathematical ratios at all.<sup>57</sup> Actually, there is no foundation at all for any analogy between proportion in architecture and harmony in music. However, if we decide that the aim of proportion is the repetition of shapes and ratios in order to create unity in a design, it becomes a comparatively elementary matter to explain the value of musical proportion.

### ⑥ The Modulor

The Twentieth Century architect to most frequently use a proportional system was Le Corbusier. The Modulor is the proportioning system developed by Le Corbusier based on the Fibonacci Series: 1, 1, 2, 3, 5, 8, 13. He believed these proportions to be evident in the human body. The Fibonacci Series is also the closest approximation in whole numbers to the golden proportion. The Modulor in Le Corbusier's story combines square and Golden Sections, but as a result it does not offer anything other than a modular system. From a blue series of numbers (Golden Section of the total height of a human being) and a red series (height of the navel) results a sequence of measurements from 27 cm to 226 cm (and then much more) in increments of 27 and 16.

---

<sup>55</sup> P.H.Scholfield, op.cit., p.36

<sup>56</sup> Ibid., p.39

<sup>57</sup> Ibid., p.72.

Fig.45 Blue- and red-series in Modulor

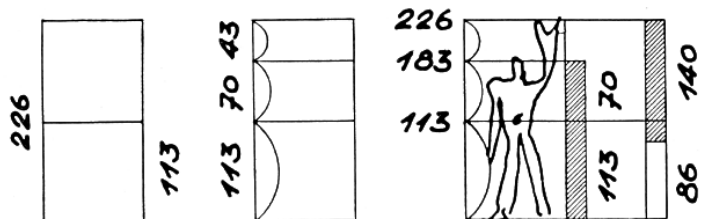

Le Corbusier used this Modulor system in his designs for Unité d'Habitation at Marseilles, Chapel at Ronchamp, the monastery at La Tourette, and the city of Chandigarh. For instance, he himself called his Unité d'Habitation a demonstration of his Modulor system. Indeed the actual measurements differed considerably from the theory: actual length 140 m, instead of Modulor length 139.01 m; width 24 m, Modulor width 25.07 m; height 56 m, Modulor height 53.10 m . Le Corbusier hoped this Modulor system would become an international methodology that would serve as a guide in the design process. Its purpose was to maintain the human scale everywhere. However, his hopes were little realised because of the limitations of the Modulor. For example, Le Corbusier, in designing large buildings like the Marseilles Unité d'Habitation, applied the system only to a restricted range of smaller elements like the interiors of the apartment, and not to the structure as a whole.<sup>58</sup>

### ⑦ The Plastic Number

The Plastic Number, discovered by Dom Hans van der Laan (1904-1991) differs from all previous systems of architectural proportions in several fundamental ways. His hypothesis of architectural proportion comes from the fact that the aesthetics of proportion is not concerned with mathematical relationships, but with clarity of perception, so that his basic ratios, approximately 3:4 and 1:7, are determined by the lower and upper limits of our normal ability to perceive differences in

<sup>58</sup> Richard Padovan, Dom Hans Van der Laan: Modern Primitive, Architectura&Natura Press, Rotterdam, 1994, p.244

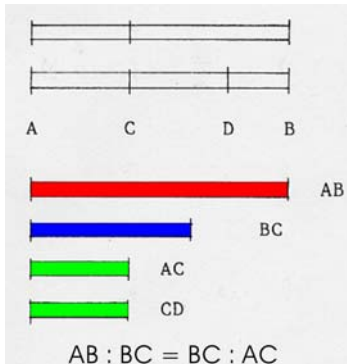

Fig.46 Single and double bisections of a line AB according to the Golden Section

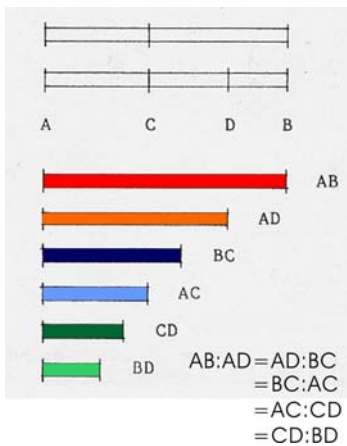

Fig.47 Single and double bisections of a line AB according to the Plastic Number

size among three-dimensional objects.<sup>59</sup> The smaller range or “margin<sup>60</sup>” delimits what Van der Laan called the “type of size”<sup>61</sup>, and the larger range the “order of size”.

The Plastic Number is comparable with the Golden Section. As shown in Fig.46, the Golden Proportion used by Le Corbusier binds only three consecutive measurements: the whole and its two parts. According to Van der Laan’s theory, the Golden Section has the great disadvantage that a second division within that ratio produces a measurement identical to the smaller part resulting from the first part. Therefore, it gives no sufficient basis for a series of proportional relationships. In order to compensate for this disadvantage, he proposed a proportion between the parts so that when the larger part is again divided, the ratio of the new larger part to the original smaller part equals that between the original parts, as shown in Fig.47. It is similar to the Fibonacci series in that an additive progression tends towards the Golden Section, but is different in that the latter largest measurement of any three consecutive measurements equals the sum of the two smallest. The relationships between the various measurements are illustrated in the following diagram<sup>62</sup>:

<sup>59</sup> Thirty-six pebbles were used to derive these limits. In sieving gravel, the limits of each grade are set by the size of the mesh. A sieve with an opening of a given size lets through all the gravel of a smaller size, but retains the larger stones. At this point, each opening size of the sieve determines the lower and the upper limits.

<sup>60</sup> The margin determines the limits within which sizes are equally large.

<sup>61</sup> Van der Laan expressed the type of size as follows: within the limit of a type of size we call all concrete measure identical.

<sup>62</sup> The eight measurements consist of pairs, by the names whole, part, piece and element – each of these has a minor and a major component. Hence, 1 is called the minor element, 2 the major element, 3 the minor piece, 4 the major piece, 5 the minor part, 6 the major part, 7 the minor whole and 8 the major whole in the diagram.

Fig.48 The order of size embraces seven consecutive types contained within eight measurements

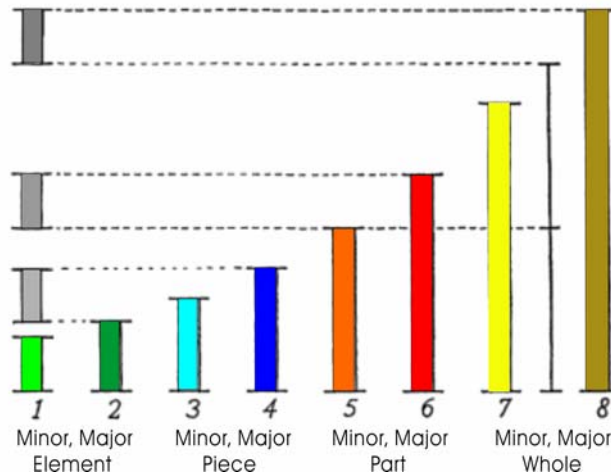

These ratios, seven in number, are expressed in terms of the relationship between the smallest measurement and the other seven. In this diagram, the minor element acts as a unit, so the ratio to it of the other measurements presents itself as a number. For instance, the major and minor parts have the same proportion to the minor element as the major and minor wholes have to the minor piece; they are therefore expressed by the ratio 4:3.<sup>63</sup> The major whole, being the sum of the major and minor parts, is expressed as the number seven. Thus, the system's eight measurements are expressed in relation to the minor element, the unit, as the following numbers:

minor element	1	minor part	3
major element	4/3	major part	4
minor piece	7/4	minor whole	16/3
major piece	7/3	major whole	7

Conversely, the measurements can also be regarded as parts of the major whole:

<sup>63</sup> The source for this ratio comes from is well described in Van der Laan's book "Architectonic Space: Fifteen lessons on the disposition of the human habitat", translated by Richard Padovan, E.J.Brill, Leiden, 1983, p.p.84-87

minor element 1/17    minor part 3/7  
 major element 3/16    major part 4/7  
 minor piece 1/4    minor whole 3/4  
 major piece 1/3    major whole 1

When the minor element of system I is given as the value 100, the value for system II and III can be derived from the relationships between the various measurements<sup>64</sup>.

Table 4 System I, II, III

Systems	elements		pieces		parts		wholes	
I	100	132 1/2	175 1/2	232 1/2	308	408	540 1/2	716
II	14	18 1/2	24 1/2	32 1/2	43	57	75 1/2	100
III	2	2 1/2	3 1/2	4 1/2	6	8	10 1/2	14

Numerical values for the measurements of two consecutive derived systems, I a and II a, can be established, taking into account the small quanta from the lower systems. To obtain these values, each authentic measurement is subtracted from its corresponding measurement from the system below:

Table 5 System I, II, I a

Systems	elements		pieces		parts		wholes	
I	100	132 1/2	175 1/2	232 1/2	308	408	540 1/2	716
II	14	18 1/2	24 1/2	32 1/2	43	57	75 1/2	100
I a	86	114	151	200	265	351	465	616

Table 6 System II, III, II a

Systems	elements		pieces		parts		wholes	
II	14	18 1/2	24 1/2	32 1/2	43	57	75 1/2	100
III	2	2 1/2	3 1/2	4 1/2	6	8	10 1/2	14
II a	12	16	21	28	37	49	65	86

The numerically deduced progressions are, in general, sufficient for the application of the measure-systems to the linear dimensions of square forms in architecture.

<sup>64</sup> The concrete content and relationships of three measurement-systems is well described in the same book by Van der Laan on pages 88-98.



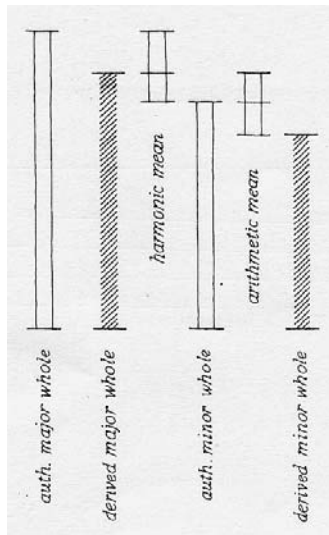

Fig.49 Relationships between the measurements

If one measurement were to be derived from the original eight authentic systems, eight new derived systems would arise, from which either the breadth or the length could be derived. For instance, the numerical values for a length of 716 are described as above in Table 5. The number 716 represents the composition of the major whole, which we regard as the sum of 700, 14 and 2; in other words, seven times the minor element (7x100) plus the minor element from the system in which 100 is the major whole (14), plus the minor element from the lower system in which 14 is the major whole (2).

The measurements derived from these systems have harmonious relationships with each other. For example, the derived major whole (system 1 a) is the harmonic mean between the authentic major and minor wholes and the latter is the arithmetic mean between the derived major and minor whole, as shown in Fig.49.

This relationship can be extended to a systematic arrangement as a large, two dimensional, right-angled triangle, also including three dimensions:

Fig.50 Two dimensional diagram of measurements of the Plastic Number

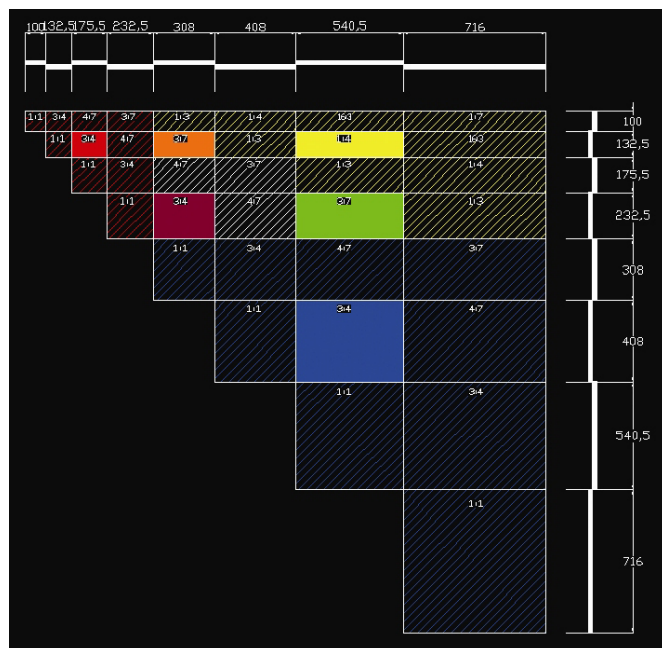
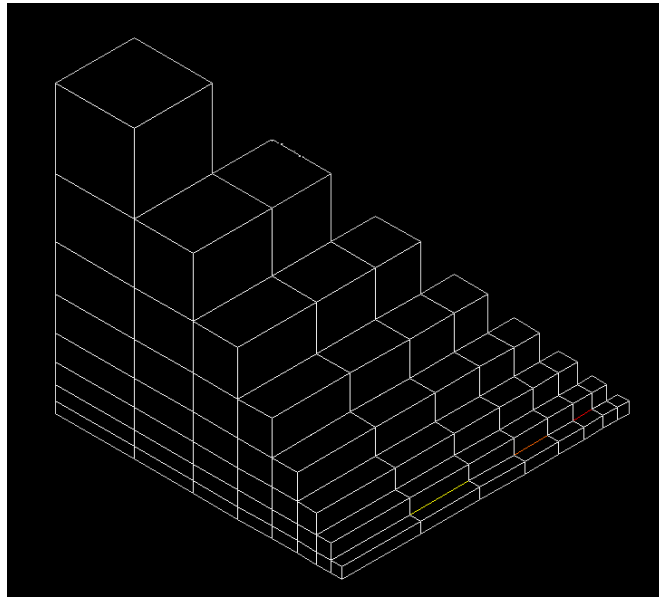

Fig.51 Three dimensional illustration of measurements of the Plastic Number



These relationships can be translated into superimposed ratios between the measurements of a system. The ancients always based the column-spacings of their temples on fixed ratios. Throughout Vitruvius' "The Ten Books", the forms of buildings are described mathematically, in terms of numerical relationships. He specified five types, with specific ratio of column thickness to intercolumniation, which were measured between faces of columns, not centre to centre, and to column height.<sup>65</sup> In the case of the Pychnostyle, the ratio of the column-interval, measured centre-to-centre, to the diameter is equal to that between the derived minor part to the minor element, 265:100. The ratio of the Systyle is 308:100, in other words that between the minor part and the minor element. Eustyle is 351:100 (the derived major part to the minor element), Diastyle 408:100 (the major part to the minor element) and Araeostyle 465:100 (the derived minor whole to the minor element). Given a numerical value of 100 for the column interval, the value for the diameters is given within the measurement of the previously mentioned system, as shown

---

<sup>65</sup> Heiner Knell, Vitruvius Architekturtheorie – Versuch einer Interpretation, Wissenschaftliche Buchgesellschaft, Darmstadt, 1985, p.p.76-77

in Table 7.<sup>66</sup>

Table 7 A measurement-system for the ancient temple columns

Systems	elements		pieces		parts		wholes	
					Systyle	Diastyle		
I	100	<del>132 1/2</del>	<del>175 1/2</del>	<del>232 1/2</del>	308	408	540 1/2	716
II	14	18 1/2	24 1/2	32 1/2	43	57	75 1/2	100
I a	86	114	151	200	265	351	465	616

Pycnostyle      Eustyle      Araeostyle

These ratios analysed by Vitruvius in the ancient temples can be transformed into simple integer ones as in the following Table 8. (d: diameter, i.c.: intercolumniation, h: column height) The great merit of Van der Laan's proportion system lies not in the details of its mathematics, but rather in the broad concepts of types and orders of size. For this reason, each measurement in his system is conceived as "about so large": very flexible. They can be given a length in metres, centimetres, millimetres or even feet and inches, according to need.<sup>67</sup>

<sup>66</sup> Van der Laan, op.cit., p.p.139-141

<sup>67</sup> Ibid., p.100

Table 8 Five types of orders and the corresponding ratios according to the Plastic Number

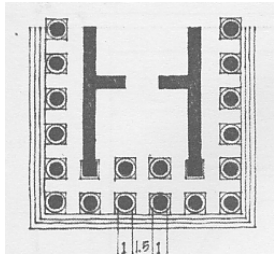
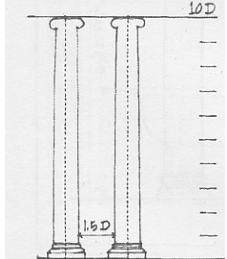
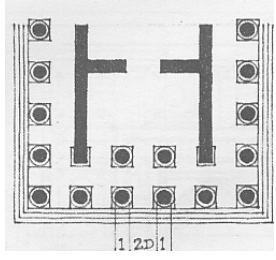
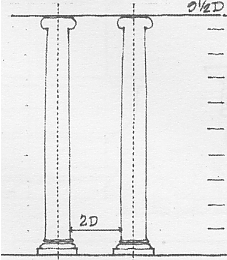
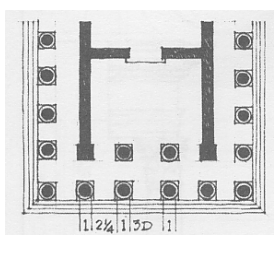
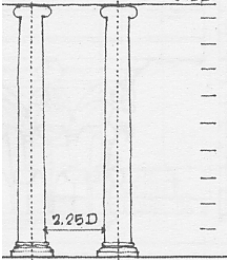
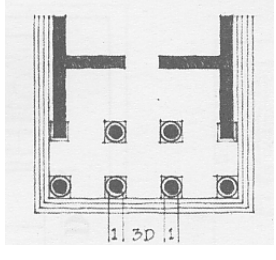
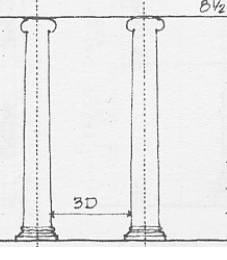
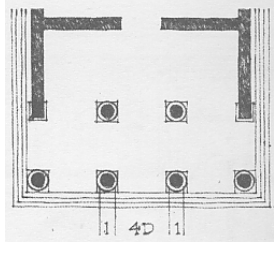
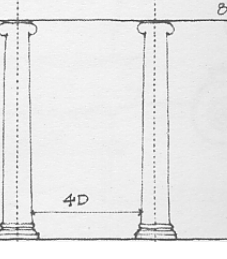
Type	Ratio (d:i.c.)	Diagram	Ratio (d:h)	Diagram
Pycnostyle	2:3		1:10	
Systyle	1:2		2:19	
Eustyle	4:9		2:19	
Diastyle	1:3		2:17	
Aræostyle	1:4		1:8	

---

### 3.1.3 Rhythm and Balance

---

#### 3.1.3.1 Rhythm

Perceptionally, the human mind possesses an intrinsic tendency to group random phenomena into rhythmic patterns. For example, a six digit telephone number is invariably remembered either as three groups of two or two groups of three. This “rhythm demand” has arisen for two reasons. First, it helps in the organization and management of data, assisting both memory storage and recall. Secondly, rhythm is undoubtedly a source of satisfaction in its own right.<sup>68</sup>

Rhythm refers to the regular or harmonious recurrence of lines, shapes, forms, or colours. It incorporates the fundamental notion of repetition as a device for organizing forms and spaces in architecture. Therefore, the principle “rhythm” is basically related to movement and repetition of the elements of architecture.<sup>69</sup> Architecture has demonstrated every variation in the management of rhythm from ancient times to today. Medieval cathedral builders were expert at integrating numerous rhythms of different frequency. Renaissance architects achieved a high level of complexity in the deployment of rhythm, invariably within the constraints of the classical rules of measurement and proportion. In the square at Telc in Czech Republic, built during the 16<sup>th</sup> Century, the rhythm of arcades (A-A-A-A) and windows (B-B-B-C-B-B-B-C) is slightly disrupted towards the base by the house units, while the rhythm of the roofs (D-D-D-D, d-d-d-d) reestablishes the unity of each house. These horizontal sections consist of three types: the uniform rhythm of the arcades and roofs, and the asymmetrical one of the windows.



Fig.52 View of the square of Telc, Czech Republic

---

<sup>68</sup> Peter F. Smith, op.cit., p.24

<sup>69</sup> David A. Lauer, Design Basics, Holt, Reinhart and Winston, New York, 1979, p.141

Fig.53 Analysis of façade of Telc

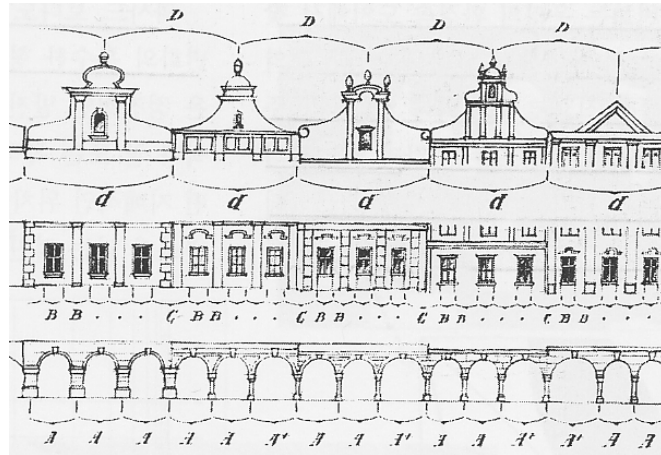

Above all, Le Corbusier, in his later buildings, employed rhythm in a vigorous manner. At the monastery of La Tourette, optical balance is maintained by the combination of the vertical and horizontal rhythm, although externally the building is heavy; at this point, the vertical rhythm is dependent on the density of vertical surface of the wall sections.

Fig.54 Rhythm used by Le Corbusier in the La Tourette

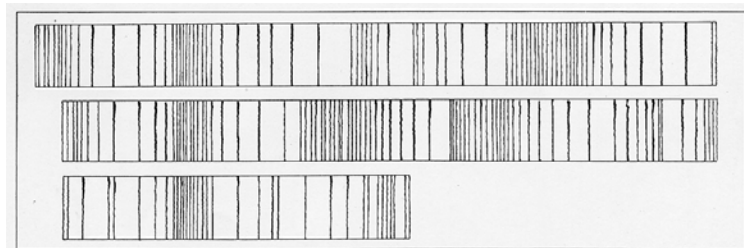

Additionally, Le Corbusier added a vertical rhythm of alternate wide and narrow divisions in the Carpenter Centre for the Visual Arts, as shown in Fig.55.



Fig.55 Rhythm used by Le Corbusier in the Visual Arts



This rhythm is divided generally into two categories: even and odd rhythm. A very common symmetry is even rhythm such as 3, 5 or 7 time.<sup>70</sup> Above all, the use of 3, 5, 7 time is of greatest importance in the grouping of buildings. 3, 5, 7 time rhythm brings together and gives focus, thereby creating a considerably stronger impression of a form, moreso than 4,6,8 time rhythm, which continually threatens to break down into

<sup>70</sup> Rudolf Wienands, op.cit., p.p.105-114

two or more parts; the latter permits a gap to exist within a maximum of two sequences of elements, for the creation of an axis of symmetry.

In short, odd rhythm, such as 3, 5 or 7 time, always has the power to determine symmetry through its centre axis. This element “rhythm” alone can not achieve unity in a design. However, it contributes significantly to empowering the existing ordering principle. Representative kinds of different symmetrical time-rhythms in architecture are described as the following Table 9:

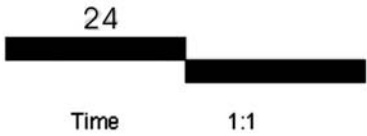
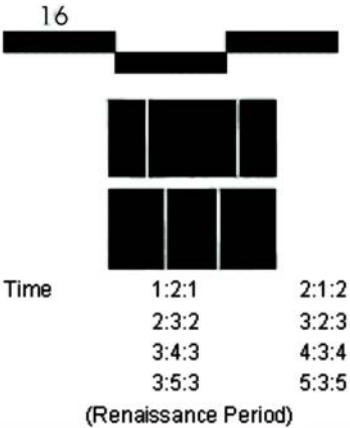
Table 9 Different symmetrical time-rhythms

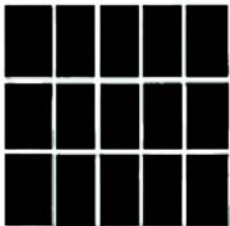
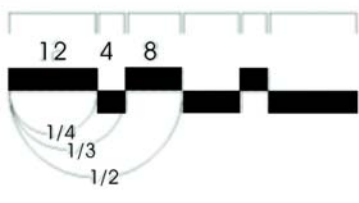
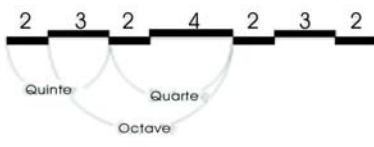
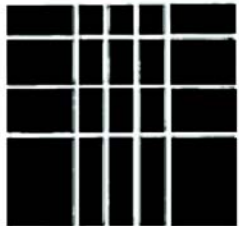
2 time - Rhythm	3 time - Rhythm
 <p>24</p> <p>Time 1:1</p>	 <p>16</p> <p>Time 1:2:1 2:1:2 2:3:2 3:2:3 3:4:3 4:3:4 3:5:3 5:3:5</p> <p>(Renaissance Period)</p>
4 time - Rhythm	5 time - Rhythm
 <p>12</p>	 <p>Time 10:3:9:3:10 2:1:2:1:2</p> <p>(R.Schindler, Le Corbusier)</p>
6 time - Rhythm	7 time - Rhythm
 <p>12 4 8</p> <p>Time 3:1:2:2:1:3</p> <p>(R.Schindler)</p>	 <p>2 3 2 4 2 3 2</p> <p>Time 2:3:2:4:2:3:2 1:1.5:1:2:1:1.5:1</p> <p>(Symmetrical musical rhythm)</p>
Combination	
	



---

### 3.1.3.2 Balance

Balance is a universal aim of composition and involves some sort of equal distribution of visual weight.<sup>71</sup> In assessing pictorial balance, we always assume that there is a central, vertical axis and usually expect to see some kind of equal weight distribution on either side. This axis functions like the fulcrum on a scale or seesaw, and the two sides should achieve a sense of equilibrium. When this equilibrium is not present, a certain vague uneasiness or dissatisfaction results within us. We feel a need to rearrange the elements, in the same way that we automatically straighten a picture on the wall or a dangerously tilting ladder.<sup>72</sup>

The balance that this author will describe here differs from common balance, which merely repeats an element in a mirror image and corresponds to symmetry. In this balance, more subtle factors are involved in attempting to balance dissimilar items. This is based on equal visual attractiveness; dissimilar objects that are equally interesting to the eye. In this case, it is generally achieved in the three ways: through colour contrasts, through form and texture and through position.



Fig.56 Colour always dominates form

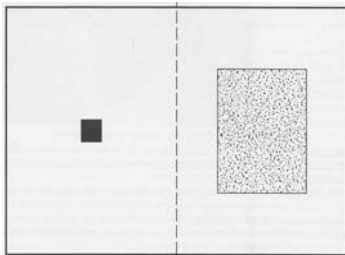

Fig.57 Balance through colour contrast

#### ① Balance through Colour Contrasts

Colour always dominates form.<sup>73</sup> This means that two or more of the same forms can be regarded as other forms depending on the use of colour. Thus, it is possible to presume that a visual balance of design can be achieved by colour. Here, one element that attracts our attention is value difference, a contrast of light and dark. Fig.57 illustrates that black against white is a stronger contrast than grey against white; therefore, a smaller amount of black is needed to visually balance a larger amount of grey.<sup>74</sup>

---

<sup>71</sup> David A. Lauer, op.cit., p.38

<sup>72</sup> Ibid., p. 36

<sup>73</sup> Rudolf Wienands, op.cit., p.180

<sup>74</sup> David A. Lauer, op.cit., p.48

The other colour contrasts, such as that of hue, of cold and warm, contrast of saturation, complementary contrast, size contrast and simultaneous colour contrast, can be applied in the same way. These other contrasts are described in the section 3.2.

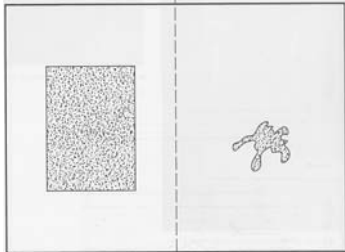

Fig.58 Balance through form

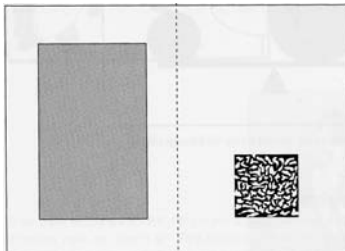

Fig.59 Balance through text



Fig.60 Ford Foundation Building

### ② Balance through Form and Texture

Fig.58 illustrates balance through form. Here the two elements are exactly the same colour, have exactly the same value and texture. The only difference is in their form. The smaller form attracts the eye because of its more complicated contours. Though small, it is equally as interesting as the much larger, but less interesting, rectangle.

Any visual texture having a variegated dark and light pattern holds more interest for the eye than a smooth, untextured surface. Fig.59 illustrates this idea: the smaller, rough-textured area balances the larger, basically untextured area.<sup>75</sup>

This principle can be applied to an architectural design. The Ford Foundation Building in Fig.60 is an example of this. The visual weight and attraction of the two sides are balanced by using very different elements and materials. The strong, simple, rectangular areas of brown granite on the left are visually balanced by the lighter but more intricate window pattern of reflecting glass on the right. This change and contrast provides visual interest and excitement.

### ③ Balance through Position

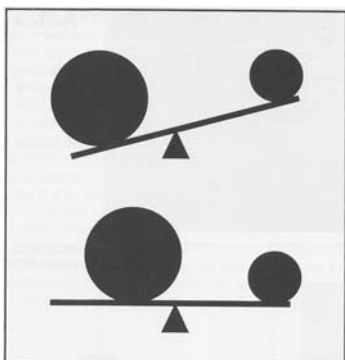

Fig.61 Balance through position

The two see-saw diagrams in Fig.61 illustrate the idea of balance through position. It is a well-known principle in physics that two items of unequal weight can be brought to equilibrium by moving the heavier item toward the fulcrum. In design, this means that a large item placed closer to the centre can be balanced by a smaller item placed out toward the edge.

Piet Mondrian's sketch illustrates well a basic principle of

<sup>75</sup> Ibid., p.p.50-53

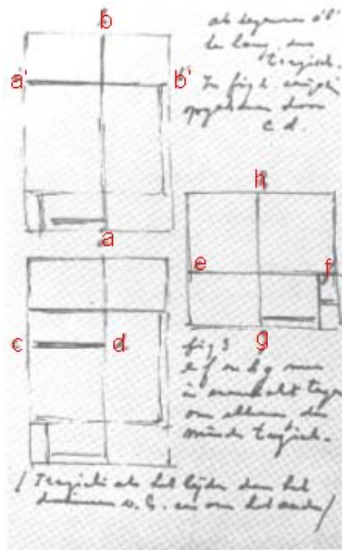

Fig.62 Piet Mondrian's sketch concerning balance



Fig.63 Balance in the Pantheon of Liberty and Democracy by Oscar Niemeyer

balance through position in paintings. In Fig.62, “ab” compared to “a’b’” in the first is long, thus unbalanced. In the second, the unbalanced relationship between lines “ab” and “a’b’” is somewhat softened by the line “cd”. Hence, the visual balance in this sketch is achieved by the combination of the lines “a’b’+cd” and “ab”. In the last sketch, the lines “ef” and “hg” are more in balance.<sup>76</sup>

Fig.63 shows the Pantheon of Tancoedo Neves, also known as the Pantheon of Liberty and Democracy by the architect “Oscar Niemeyer”. The design of the two wings of white reinforced concrete is developed in a horizontal organized way. The whole building is in harmony with the background “horizontal” ocean and is balanced throughout the vertical axis by the juxtaposed obelisk. The two volumes complement each other and then achieve a sense of balance through their positional-contrast.

<sup>76</sup> Cornelis van de Ven, Space in Architecture – The evolution of a new idea in the theory and history of the modern movements, Van Gorcum & Comp.B.V., Assen in the Netherlands, 1987, p.206

---

## 3.2 Colour Theory of Architecture

According to Joseph A. Gatto's book "Elements of Design, Colour and Value", colour has the power to interpret our environment. It provides an ever-changing source of visual and emotional stimulation in numerous aspects of our lives. It conjures up very different ideas for each of us. To the physicist, colour is determined by the wavelength of light. To the physiologist and psychologist, our perception of colour involves neural responses in the eyes and the brain, and is subject to the limitations of our nervous system. To the naturalist, colour is not only a thing of beauty but also a determination of survival in nature. To the social historian and the linguist, our understanding and interpretation of colour are inextricably linked to our own culture. To the art historian, the development of colour in painting can be traced to both artistic and technological origins.<sup>77</sup> For the architect who deals with various kinds of visual works such as painting, sculpture and building, colour provides a means of expressing feelings and the intangible, making possible the creation of a work of art.

Classic works in the history of colour theory include Boyle's "Considerations Touching Colours (1664)", Newton's "Opticks (1704)", Goethe's "Farbenlehre (1801)", and Chevreul's "De la loi du contraste simultané des couleurs (1845)". None was widely circulated among a wide audience, and the issues they raise are technical and complex. The most popularly influential and commercially successful of modern theorists were Albert H. Munsell (1858-1918), Wilhelm Ostwald (1853-1932), and their interpreters including Faber Birren.<sup>78</sup> The technical aspect of colour theory covers questions as to how, for instance, orange and other colours are mixed and behave in mixtures. The aesthetic aspect of colour theory is an inquiry

---

<sup>77</sup> Trevor Lamb and Janine Bourriau, *Colour: Art & Science*, Cambridge University Press, Cambridge, 1995, p.1

<sup>78</sup> Patricia Sloane, *The visual nature of colour*, Design Press, New York, 1989, p.273

into the harmoniousness of orange and other colours in combination with one another. This chapter will focus on the latter aspect of colour theory.

---

### 3.2.1 Overview of Colour Characteristics

---

#### 3.2.1.1 Three Properties of Colour

Colour has three properties: hue, intensity and value.

Hue refers to the name of a colour; e.g. red, blue and purple.

Intensity is used to describe the brightness and purity of a colour. When a hue is strong and bright, it is said to be high in intensity. When a colour is faint, dull and grey, it is said to be low in intensity.

When describing a hue, value refers to its lightness or darkness. Value changes are often obtained by adding black or white to a hue. The following Fig.65 is an example of a value scale that has values ranging from the darkest dark, to the whitest white.



High intensity      Low intensity

Fig.64 Intensities of Green



Shade

Tint

Fig.65 Value scale

---

#### 3.2.1.2 Colour Notation

Among familiar chemical symbols, Na, Fe, O, H, and Cl respectively identify atoms of sodium, iron, oxygen, hydrogen, and chlorine. In chemistry, these and symbols for the other elements can be combined into formulas that display the result of chemical combination. The chemical notation for water, H<sub>2</sub>O, indicates that the molecule consists of two atoms of hydrogen (H), one of oxygen (O)<sup>79</sup>.

In Munsell's notational system, following the format used in chemistry, letter symbols are provided for each of ten major

---

<sup>79</sup> Ibid., p.253

hues. The hue symbols are as follows:

<i>R</i>	<i>red</i>
<i>YR</i>	<i>yellow-red</i>
<i>Y</i>	<i>yellow</i>
<i>GY</i>	<i>green-yellow</i>
<i>G</i>	<i>green</i>
<i>BG</i>	<i>blue-green</i>
<i>B</i>	<i>blue</i>
<i>PB</i>	<i>purple-blue</i>
<i>P</i>	<i>purple</i>
<i>RP</i>	<i>red-purple</i>

Each colour term in this section is named according to the above-mentioned notation of Munsell.

---

### 3.2.1.3 Primary, Secondary and Tertiary Colours

**The primary colours** are a set of colours from which all other colours can be mixed.

Leonardo da Vinci listed the primary colours as black, white, blue, yellow, green, umber, purple, and red.

In *Principles of the Science of Colour*, William Benson identified the primary colours as red, green, and blue. The English physician and amateur Egyptologist Thomas Young believed that red, yellow, and blue were the primary set. Similarly, the twentieth-century citizen asked to identify the primary colours usually names red, yellow, and blue.<sup>80</sup>

**The secondary colours** are orange, green and violet. Mixing equal amounts of two primary colours together makes secondary colours. As a result, they are located midway between the primary colours on the colour wheel. Orange is made by mixing red and yellow, green is made by mixing blue

---

<sup>80</sup> Ibid., p.294

and yellow, and violet is mixed by blue and red.

*Yellow* + *Red* = *Orange*  
*Red* + *Blue* = *Violet*  
*Blue* + *Yellow* = *Green*

**Tertiary colours** are also known as intermediate colours. Both terms refers to the colours found between the primary and secondary colours. Mixing uneven amounts of two primary colours together makes tertiary colours. Examples of tertiary colours are Yellow-Green, Blue-Green and Red-Violet.

*Orange* + *Violet* = *Red-Violet*  
*Violet* + *Green* = *Blue-Green*  
*Green* + *Orange* = *Yellow-Green*

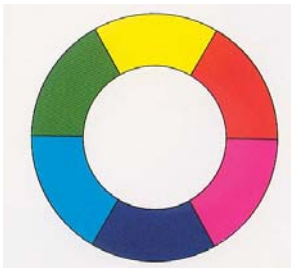

Fig.66 Six-colour wheel



Fig.67 Twelve-colour wheel



Fig.68 Twentyfour-colour wheel

#### 3.2.1.4 Colour Wheel

A colour wheel is often used to help explain and understand colour. In architecture, the most important colour wheels are divided into three categories: six-colour wheel, twelve-colour wheel, and twentyfour-colour wheel.

##### The six-colour wheel

The six-colour wheel consists of yellow, orange, red, violet, blue, and green.

##### The twelve-colour wheel

The twelve-hue colour wheel is divided into yellow, yellow-orange, orange, red-orange, red, red-violet, violet, blue-violet, blue, blue-green, green, and yellow-green.

##### The twentyfour-colour wheel

Fig.68 illustrates the twentyfour-colour wheel.

---

### 3.2.2 Colour Contrasts

Contrast is defined as when approximate differences are found between two colour effects that are matched mutually.<sup>81</sup> A lot of artists and scientists, like Goethe, Hölzel and Itten, referred to the importance of various colour contrasts. Colour contrasts are a basis for and a guideline to better design. There are seven different kinds of contrasts; Contrast of Hue, Light-Dark Contrast, Cold-Warm Contrast, Complementary Contrast, Simultaneous Contrast, Size Contrast and Contrast of Saturation.

Designers should keep in mind that no piece of work makes use of only one type of those contrasts.



Fig.69 Contrast of hue

---

#### 3.2.2.1 Contrast of Hue

Contrast of hue is formed by the juxtaposition of different hues. The greater the distance between hues on a colour wheel, the greater the contrast. In order to achieve high intensity of colours, three distinguishable colours, at least, are necessary. The strongest contrast is obtained by colouring with the primary colours: yellow, red and blue.

These colours can be easily observed from a great distance, so that they are normally used at work for warnings, emergencies and safety signs. Additionally, these colours can be used in show-room windows because of their optical attraction. As shown in Fig.69, a dynamic and creative space can be presented using various pure and highly saturated colours: the combination of primary and secondly colours.

---

#### 3.2.2.2 Light-Dark Contrast

---

<sup>81</sup> Johannes Itten, *Kunst der Farbe*, Otto Maier Verlag, Ravensburg, 1970, p.33.



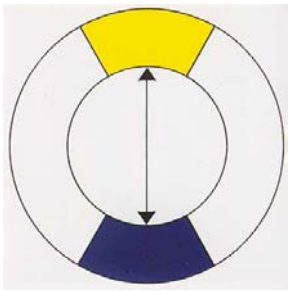
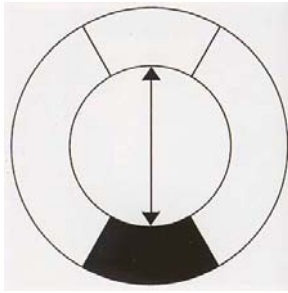

Fig.70 Strong light-dark contrast

Light-dark contrast is contrast between light values and dark values. The farther apart two colours are on a black-and-white scale, the more contrast there is between them. The light-dark contrast refers not only to the black and white tones but also to the strong difference between each colour. For instance, the strongest light-dark contrast in the six-colour wheel uses yellow and violet colour tones.

This contrast can play a great role in designing exterior and interior architecture. Through the changing of the colour-size more tension is achieved, and through the quality of this contrast more optical attraction can be achieved.

The left two figures in Fig.70 show the four possibilities for the guidance of paths in space, and the façade that consists of dark (below) and light (above) colour tones in the right-hand figure seems to be static and gives us optical stability. The colour that vertically becomes lighter towards the upper part of the building seems to make the building appear lighter, even though its mass is heavy.

Fig.71 Examples of light-dark contrast

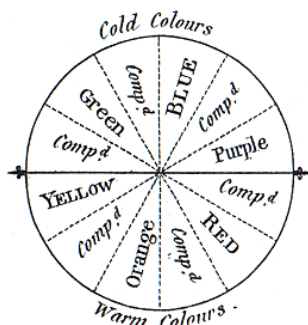

### 3.2.2.3 Cold-Warm Contrast

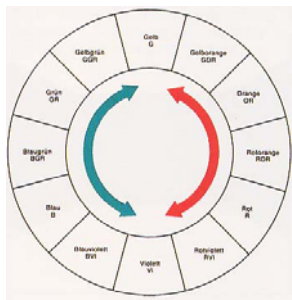

Fig.72 The first and standard warm-cold colour diagram

The concept of cold-warm contrast came to the fore in artists' thinking during the middle of the 18th century, but was first systematically presented in the English artist Charles Hayter's "Introduction to Perspective" in 1813. As shown in Fig.72, sky blue is placed at the top, because in Hayter's time it was defined as the purest or most fundamental colour. Cool colours consist of blue, green and purple and warm colours consist of red, orange and yellow in the six-colour wheel.



Fig.73 Strong visual impact of the cool background, by using cold-warm contrast

Because cool colours are often darker and less intense than their warm complements, many artists find it is effective to use them as a background for warm colours. Like the setting for a jewel or an object, they provide an enhancing contrast. The warm colours capture our attention and seems to stand out from the cool background, in the same way that light stands out in darkness, as shown in Fig.73.

Warm and cool colours work together to create a sense of movement, warm colours advancing and cool colours receding. The coolest colour is usually whatever provides the best visual contrast to the warm hue already selected. When a cool atmosphere dominates, warm contrasts keep an optical attraction from seeming unpleasantly chilly. The architectural application of this relationship will be treated in the next section 3.2.3.

#### 3.2.2.4 Complementary Contrast

Complementary Contrast refers to the contrast between complementary (opposite) colours. Complementary colours are those that are directly opposite each other on the colour wheel. Lightness is a major harmonizing factor, and is already implicit in the classic complementary colour pairs: yellow is very light and violet very dark, orange somewhat light and blue somewhat dark, while red and green are both medium-light. So complementary colours are opposite each other on the colour wheel, but are also balanced so that their average or mixed lightness is always approximately equal to a mid-valued grey, as shown in Fig.74:

Fig.74 The mix of each complementary colour

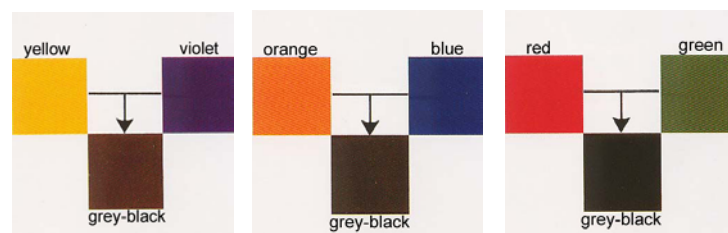

Since the principal reason for using complementary colours is to enhance the impact of visual design, artists have usually adjusted their complementary colour selections to produce the most effective colour contrasts within a specific painting. Chroma is sometimes harmonized by making the intensity of the colours approximately equal, but this is difficult to do with more intense colours because warm coloured pigments in general have a higher maximum chroma range than their cool-coloured complements. So, complementary pairs are more often adjusted through the size of the balanced colour areas, as shown in Fig.75: large areas of unsaturated colour around small areas of intense colour. The unsaturated colour has a lower chromatic intensity, but there is visually more of it; the saturated colour is intense, but of a small quantity. In this way the visual impact of the two colours is made roughly equal.

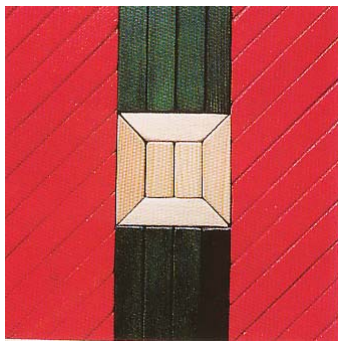

Fig.75 An example of complementary contrast

### 3.2.2.5 Size Contrast

Size contrast refers to the relative area or quantity of colour. As shown in Fig.76, a large area of colour makes a strong statement, but many small areas of colour, especially if they are very intense and surrounded by a large area of lower intensity, can create energy and movement. A pure colour can be overwhelming, so when the large area is lower in intensity, even small bits of colour within it appear brighter than usual. Goethe, whose book “Farbenlehre” is still one of the comprehensive studies of colour<sup>82</sup>, examined the effect of colours and gave the lightness values specific numbers. The numbers are approximate values, but they can be useful in the design phase.<sup>83</sup> According to the book “Farbenlehre für Handwerksberufe” by Geckenberger, the light value for

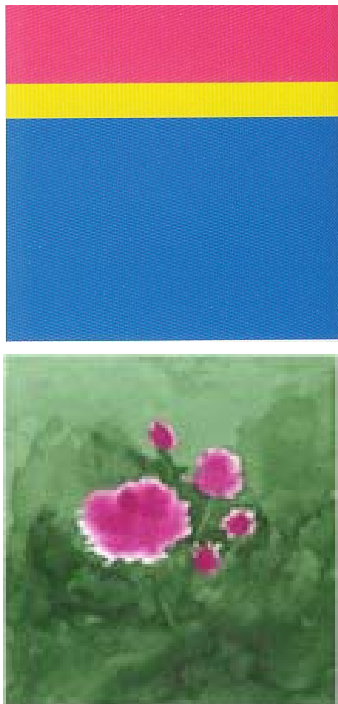

Fig.76 Examples of size contrast

<sup>82</sup> John Gage, Colour and Meaning – Art, Science, and Symbolism, University of California Press, Los Angeles, 1999, p.169

<sup>83</sup> Otmar Geckenberger, Farbenlehre für Handwerksberufe, Deutsche Verlags-Anstalt, Stuttgart und München, 2001, p.33

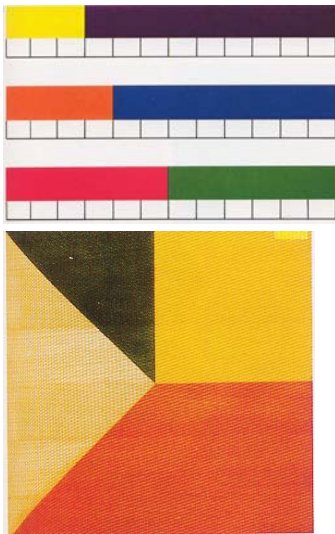
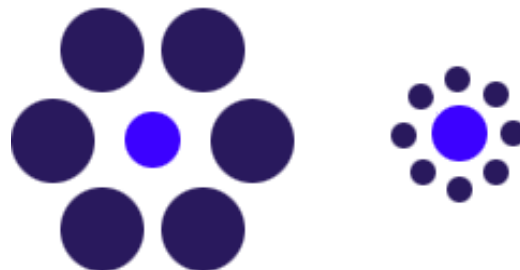

Fig.77 Application of Goethe's size contrast



Fig.78 Size contrast in a façade

Fig.79 Simultaneous contrast relating to size



harmonious combination of colours are shown in the six-colour wheel as follows:

Yellow	Orange	Red	Violet	Blue	Green
3	4	6	9	8	6

If these values are used with each other in the six-colour wheel, a harmonious effect can be achieved and the colour contrast in relation to the size is neutralized. In an architectural design, this relationship can also be applied in different ways, so that a harmonious colour-design can be achieved.

A harmonious façade that consists of different finishes such as plaster, stone, and wood can be created by the use of the size-colour contrast as shown in Fig.78.

### 3.2.2.6 Simultaneous Colour Contrast

The simultaneous colour contrast appears when colours are placed side-by-side, and viewed at the same time; that is, all colours influence each other mutually. Fig.79 below illustrates how the blue circle surrounded by smaller circles appears larger than it does when surrounded by larger circles. This relationship is concerned with hue, chroma and lightness in a specific context.

#### Lightness

The most powerful example is the apparent shift in lightness



Fig.80 Colour shift in a simultaneous lightness contrast



Fig.81 Colour shift in a simultaneous chroma contrast



Fig.82 Colour shift in a simultaneous hue contrast

of identical mid-value squares surrounded by a colour of darker or lighter tonal value. If the surrounding colour is darker, the central square appears lighter; if the surrounding colour is lighter, the central square appears darker.

### Chroma

The next strongest visual effect is the apparent shift in chroma of identical coloured squares. In Fig.81, the difference in chroma alone is enough to cause an obvious colour shift: the small square on the right appears darker and duller, while the square on the left appears lighter and more intense.

### Hue

The central square can be surrounded by colours contrasting in hue but identical in chroma and lightness. As shown in Fig.82, the apparent size of the centre square is dependent on the surrounding hue. However, this hue shift is hard to demonstrate.

---

#### 3.2.2.7 Contrast of Saturation

This term refers to the contrast between pure intense colours and dull, diluted or greyed colours. Dull colours appear to be duller when they are placed next to pure, intense colours, and pure intense colours appear more vivid when they are next to a dull colour. The saturation of colours is normally reduced by white, black, grey and the complementary colour tones. Colours can be mixed for each purpose. This is especially suitable for the design of façades and interior spaces. Fig.83 shows the colour diagram and the effects of adding the specific colours.



Diagram	Added Colour	Effect
	(Original)	
	+ White	Lighter Cooler
	+ Black	Darker Gloomy
	+ Grey	Neutral Gloomy
	+ Complementary Colour	Greyed Gloomy

Fig.83 Colour diagram and effects of saturation contrast

### 3.2.3 Psychological Effect of Colour on Architectural Space

#### 3.2.3.1 Real Axis and Sensitivity Axis

The function of walls in architectural space is to separate and connect the spaces. Thus, walls limit space. The effect of a wall varies and is particularly dependent on the following factors: the form of the wall, the size of the wall, its surface and colour.

When an observer comes into a room, he perceives the surface of the wall and the colour of the surrounding walls at the same time. The wall, in its surface appearance, affects human-perception and generates a conscious or sub-conscious reaction. Through human-perception the observer distinguishes the real axis that is concerned with the average value of two distances and the sensitivity axis that is dependent on the perception of the architectural space. For instance, as shown in Fig.84, if the surface of the surrounding walls is the same colour, the real axis and the sensitivity axis

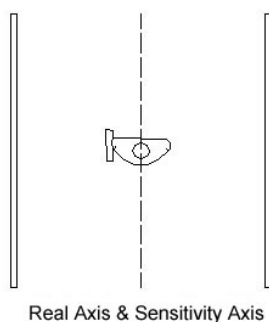

Fig.84 Real and Sensitivity Axes

are identical. On the other hand, if the surface is coloured differently, neither of the axes is identical and our feeling for the space will be changed according to the corresponding colour effect. There are two main colour-factors that influence this spatial effect: colour contrast and lightness of colour.

### Colour Contrast

As mentioned above, the light-dark and warm-cold contrasts are two typical contrasts that can be applied relatively easily to architectural design, and which work together to create a sense of movement, especially in interior design.

As in the example of the light-dark contrast in the left-hand picture of Fig.85 on the left, if two walls are coloured with opposite colour tones, the sensitivity axis shifts to the light side, whereas the real axis always stays in the same position. The right-hand figure in Fig.85 shows warm-cold contrast where the left wall is coloured yellow that is a warm colour and the right wall is coloured blue that is a cold colour.

It assumes that the lightness in these walls is identical. In this case, the sensitivity axis shifts to the left, where the warm colour is present; that is, the warm colour attracts the psychological attention of the observer more than the cold colour.

Fig.85 Shift of Sensitivity Axis by colour contrasts

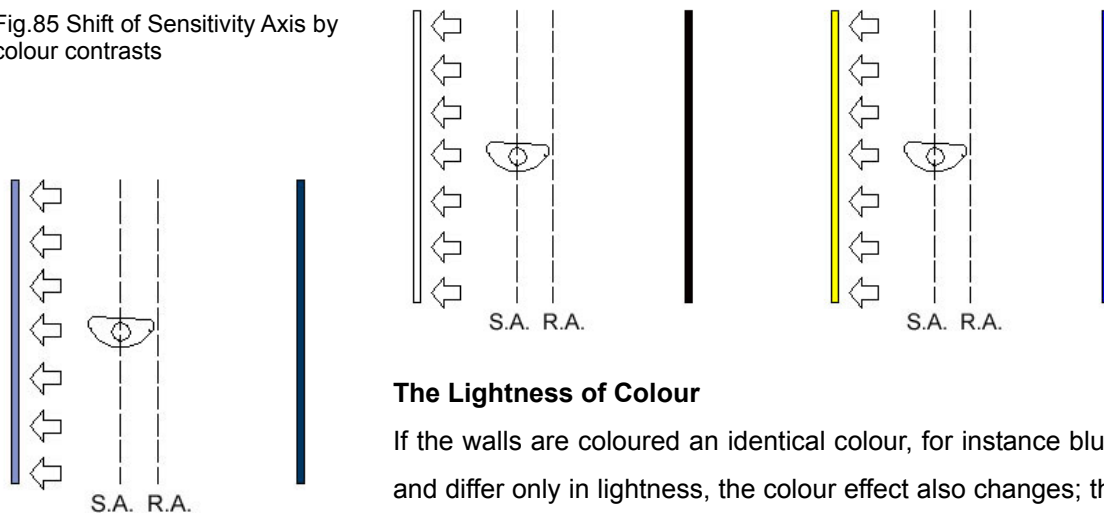

Fig.86 Shift of Sensitivity Axis by the lightness of colour

### The Lightness of Colour

If the walls are coloured an identical colour, for instance blue, and differ only in lightness, the colour effect also changes; the sensitivity axis shifts to the bright and optically lighter side.

This example is shown in Fig.86.

This principle can be usefully applied to architecture when the designer wants to utilize colour effects in one space. As shown in Fig.87, colour effect is used in a purposeful manner to control the observer's walking direction in one room, using the following colour scheme and the corresponding colour effect:

Fig.87 Colour schema and colour effect

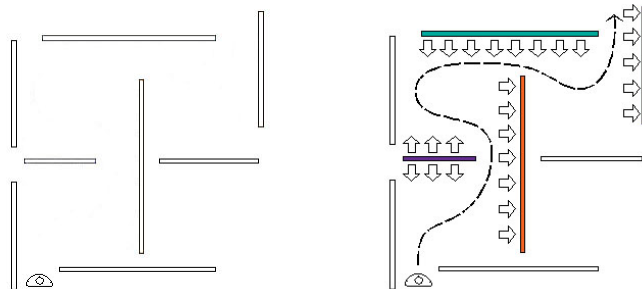

---

### 3.2.3.2 Space Effect of Colour

Colour design offers the possibility of changing the ranking of optical attention, by means of the colour and the material. This effect is achieved by a combination of colour accent, colour intensity and colour tone. The designer can create the colour design using this ranking effectively.

#### **Colour Accent**

Fig.88 shows that the left wall that is the only wall coloured in any colour tone offers the greatest optical attention. As a result, an observer first perceives the left wall and then comes into the room. In this case, the attention can be directed as follows: the left wall, the rear wall and the right wall; that is, clockwise.



Fig.88 Spatial effect using colour accent

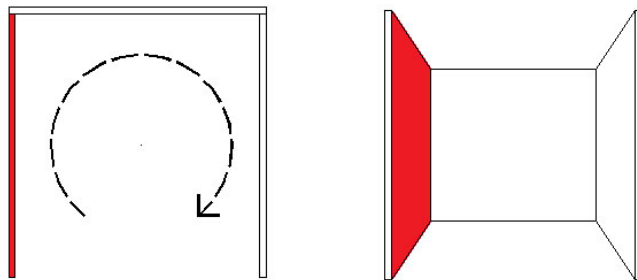

### Colour Intensity

The ranking of optical attention is also influenced by the colour intensity of the wall surface. As shown in Fig.89, there are three kinds of colour intensities: high, medium and low intensity. As the optical attention is drawn in turn from the high intensity to the low intensity, the rear wall attracts the attention of an observer first.

Fig.89 Spatial effect using colour intensity

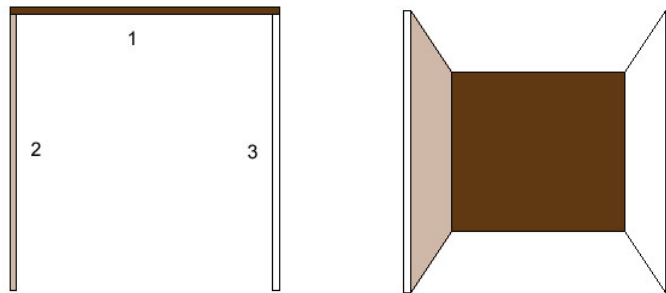

### Colour Tone

Colour tone plays a role in influencing our optical attention within a space. When warm-cold contrast is used in a space, the cold colour attracts more attention than the warm one, which is opposite to the effect of the sensitivity axis, as mentioned earlier. When the walls of a room are coloured in different colour tones, as shown in Fig.90, the cold colour attracts the optical attention first.

Fig.90 Spatial effect by colour tone

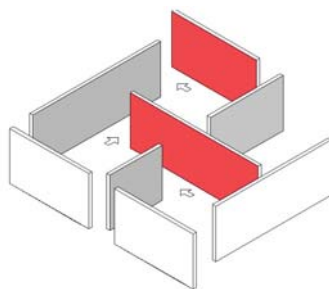
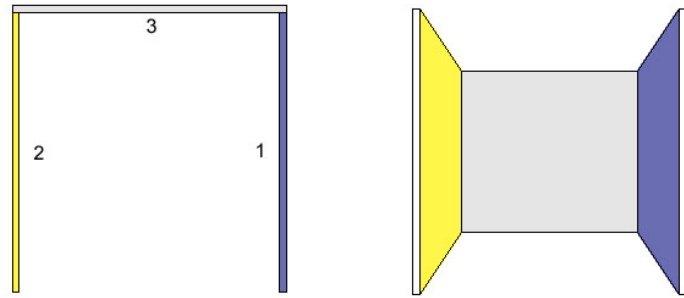

Fig.91 Guidance of walking path by colour accent

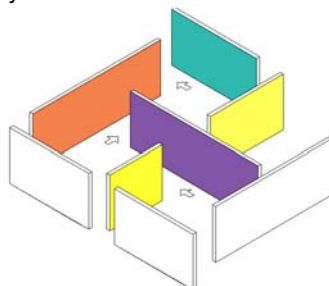

Fig.92 Guidance of walking path by colour tones

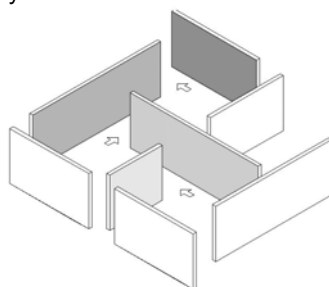

Fig.93 Guidance of walking path by colour intensity

The walking path of an observer is guided by wall arrangement, the form of the walls and optical openness related to the light and shadow in a room. Additionally, there are a lot of factors that influence space effect such as wall colour and structure of wall surface.<sup>84</sup> Spatial effect, including the guiding of the walking path, is achieved by the combination of these effects. Here, the spatial effects are demonstrated in relation to the colour characteristics.

A well-planned walking path in a room is necessary when designing a specific space such as a museum or an art gallery or a mall-centre, where an effectively-controlled walking path guide of an observer is needed. The arrangement of walls, including colour effect, between the guiding walls and the wall that is located opposite the main entrance to a room leads the observer from room to room. In this case, it is beneficial when the above-mentioned three factors are additionally used in the design. Fig.91 shows an example where the colour accent leads the observer in a certain direction. In Fig.92, the observer walks in to the room, perceiving the colour tones yellow, orange, red and violet, this colour series is one of Johannes Itten's colour harmonies. Fig.93 shows the path guidance using colour intensity. These factors play a role not only in guiding the walking path but also in creating spatial impression.

<sup>84</sup> Friedrich W. Treu, Versuch einer quantitative Bestimmung der Wirkung des architektonischen Raumes, Dissertation an der TU Hannover, 1970, p.p.24-28

---

### 3.2.4 Colour Harmony

Most people wrongly assume that harmony is the only true goal of colour combination; though most artists and designers nowadays believe that too much harmony can be boring, limiting the pleasure-giving and expressive range of colours. Besides, there are a few instances where colours settle down together and co-ordinate with ease.

In this section, the colour harmony theory of Johannes Itten and Paul Renner, who established an acceptable colour theory, are described first and then these theories are summarized, including use of general colour harmonies.

---

#### 3.2.4.1 Johannes Itten's Colour Harmony

Johannes Itten studied various colour theories at the Stuttgart Academy, where he was influenced by Adolf Hölzel's aesthetic theory. From 1916 to 1919, he gave lectures at the Bauhaus in Weimar and then established his private art school in Bern. He finally moved to Zurich, where he was Director of the Art Polytechnic Institute from 1938 to 1954 and also Director of the Textile Technical School from 1943 to 1960. His book "Kunst der Farbe" was published in 1961 and was translated into several languages.<sup>85</sup> Itten summarizes the definition of harmony in his book as follows:

*Zwei oder mehrere Farben sind harmonisch, wenn sie zusammengemischt ein neutrales Grau ergeben. Ganz allgemeine kann gesagt werden, dass alle komplementären Farbenpaare, alle Dreiklänge, deren Farben im zwölfteiligen Farbkreise im gleichseitigen oder gleichschenkligen Dreieck oder Vierklänge, die in quadratischen oder rechteckigen*

---

<sup>85</sup> Harald Küppers, Harmonielehre der Farben - Theoretische Grundlagen der Farbgestaltung, DuMont Buchverlag, Köln, 1989, p.221

*Beziehungsverhältnissen zueinander stehen, harmonisch sind.*<sup>86</sup>

*(Two or more colours are harmonious if they are neutral grey when merged. Generally, all complementary colour pairs and all triads, whose colours have a square or rectangular relationship to each other in the twelve-colour wheel, are harmonious.)*

Colour harmony can be formed from two, three, four or more colours. This is regarded as the Two Colours (Zweiklänge), Colour Triads (Dreiklänge), Colour Tetrads (Vierklänge) and etc.

### **Two Colours**

Two colours placed to each other oppositely are complementary in the twelve colour wheel. They form a harmonious relationship. The colour combinations are as follows: yellow – violet; yellow-orange – blue-violet; orange – blue; red-orange – blue-green; red – green; red-violet – yellow-green.

We must note when using this principle that two colours always stay symmetrical. If a light red is used, the corresponding green colour should also be darkened in the same degree.



Fig.94 Colour triads 1

### **Colour Triad**

If three colours are selected from the twelve-colour wheel, which is composed of the right-angled triangle, these colours have a harmonious relationship to each other.

For instance, primary colours form one triad (red, blue, yellow). A high-intensity version of this triad is often an uncomfortable colour combination for viewers. Secondary colours (orange, green, violet) form another triad. This colour scheme is less

---

<sup>86</sup> Johannes Itten, *Der Farbstern*, Otto Maier Verlag, Ravensburg, 1985, p.2

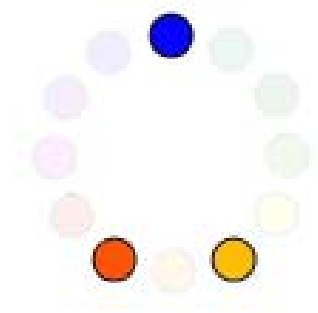

Fig.95 Colour triads 2

disturbing. The colour triads that are composed of the non-right-angled triangle are also created when a hue and the two colours on either side of its complement are used together. The effect of this colour scheme is similar to using complementary colours, except that it offers the artist a little more variety with which to work. In this way, the four-, five- and six-colour combinations are created.<sup>87</sup>

---

#### 3.2.4.2 Paul Renner's Colour Harmony

Paul Renner (1889–1956) was graphic artist, painter, type designer, author and teacher. He studied architecture and painting in Berlin, Munich and Karlsruhe. Then he worked as a painter in Munich between 1907 and 1917 and as production assistant and presentation manager for Georg Müller Verlag in Munich in 1911. In 1925-26 he was head of the commercial art and typography department at the Frankfurt Kunstschule and in 1926 Director at the Munich Grafische Berufsschule and from 1927 the Meisterschule für German book-printers. In addition to numerous books on the art of typography, he published a book with the title "Ordnung und Harmonie der Farbe (Order and Harmony of Colour)" that appeared in 1947.<sup>88</sup> In his book, Renner refers to three aesthetic distinguishing features concerning colour harmony, which he calls hue (Farbrichtung), value (Helligkeit) and intensity (Reinheit).<sup>89</sup>

The relationship between neighbouring colours derives its tension and its vivacity through these contrasts of hue, value and intensity. For colour harmony, these three elements at least have to have one similarity among them that combines the colours with each other<sup>90</sup>; that is to equalize the

---

<sup>87</sup> See the „Der Farbsterne“ by Johannes Itten for the detailed information.

<sup>88</sup> Harald Küppers, op.cit., p.p.213-214

<sup>89</sup> Ibid., p.214

<sup>90</sup> Paul Renner, Ordnung und Harmonie der Farben, Otto Maier Verlag, Ravensburg, 1947, p.p.52-53

differences in hue, value and/or intensity. For example, take the three primaries - red, yellow and blue - in their natural position and in full intensity. These hues belong to distinctly different families and they are dissimilar in terms of value, yellow being the lightest, red of a middle value, and blue of the darkest. To equalize the three colours, there are four possibilities:

- *to raise the value of the blue to much the same value as that of the red by adding white to it, and lower the value of the yellow by adding a bit of black to it*
- *to raise the values of both blue and red closer to that of yellow*
- *to lower the values of yellow and red closer to that of blue*
- *to add a bit of each of the three colours to the others so as to alter their intensities and their values, hoping not to alter them so much as to destroy their hue identity*

As in the example of a building façade, if a hue present is different to the other elements on the façade of the building, unification of colour is achieved by moderation of the similar value and intensity. Furthermore, if both hue and value are quite different to each other, colours are harmonized using similar intensity in a façade. In this way, colour harmony is achieved by a combination of the three-colour components. This relationship can be described as in Table 10:

Table 10 Six basic types of colour by Paul Renner

The contrasting component	Key component for colour harmony
Hue	Similarity of value and intensity
Value	Similarity of hue and intensity
Intensity	Similarity of hue and value
Hue + Value	Similarity of intensity
Hue + Intensity	Similarity of value
Value + Intensity	Similarity of hue

---

### 3.2.4.3 Summary of Colour Harmony

The colour theory has a major role to play in the question of the harmony of colours.<sup>91</sup> Colour harmonies fall into two broad categories: related and contrasting.

Related harmonies are subdivided into monochromatic and analogous.<sup>92</sup> Contrasting colour harmonies unite hues that are separated on the colour wheel. When two pure complementary hues are placed next to each other, the design seems to vibrate. They create a feeling of excitement that quickly attracts attention. A monochromatic colour scheme is one that uses shades, tints and tones of only one colour. Although using such a limited palette runs the risk of creating a boring design, it also causes an immediate unifying or harmonious effect. Colours next to each other on the colour wheel that have a common hue are referred to as analogous colours. Red-violet, violet and blue-violet are one set of analogous colours because they all have violet in common. The common hue creates a feeling of unity in the design by tying together each part of the design. Fig.96 shows colour diagrams of these relationships.

Fig.96 Colour diagrams of primary colour harmony

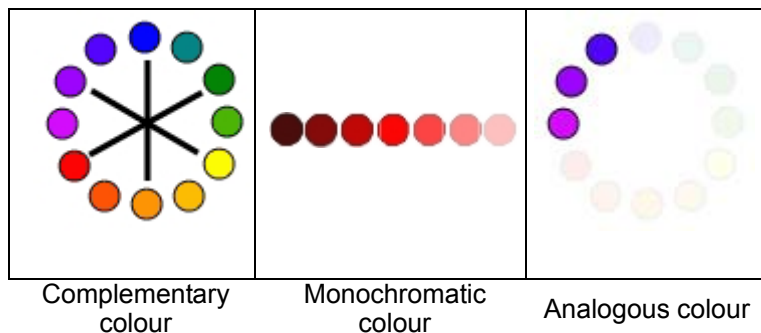

Concerning the colour harmonies of Johannes Itten and Paul Renner, the primary colour harmony is ultimately grouped into

---

<sup>91</sup> John Gage, op.cit., p.14

<sup>92</sup> See Mahnke and Frank H.' book "Colour, Environment and Human Response – An Interdisciplinary Understanding of Colour and its Use as a Beneficial Element in the Design of the Architectural Environment", Van Nostrand Reinhold Company, New York, 1996

the theories of Itten and the theory of related and contrasting colour harmony that is mentioned above. The colour harmonies such as tetrads, triads and split complementary diagrams are included in Johannes Itten's theory. Paul Renner's colour harmony can be used as a secondary harmony to develop and unify the primary colour harmony used in colour design.



---

### 3.3 Design Principles of Formal Ordering for Harmonious Architecture

Architectural theories in western architecture have been considered as a basis for answering the fundamental questions of architectonics: proportion, symmetry, colour, harmony and so on. Among these the architectural design theory is significant, because it affects the aesthetic evaluation of human perception. When we look back on past European architecture, we see that the architectural design theory started with the Pythagorean number in ancient times; this developed further in the Middle Ages and was applied to almost all religious buildings in the Renaissance Period. However, architecture gradually became recognized not as artistic work but as a necessary tool in our lives after the Renaissance, because the usage of exterior and interior architectural space became more flexible in comparison with the past, with the dazzling development of building technology in the 18<sup>th</sup> and 19<sup>th</sup> centuries.

Along with this technological tendency, the appearance of specific fields such as the urbanist in the 1950s, the socialist and the psychologist in the 1960s and the methodologist in the 1970s caused some typical fields of architecture to be divided into different branches, so that the importance of architectural design theory started to decrease.<sup>93</sup> As an example of this, the European modernism of architecture that occurred in the early twentieth century changed the original meaning of architecture, that is into a synthesis of all formative arts. The concept of the USA's commercialism of real estate, whose foundation is identical to capitalism, encouraged people to build non-traditional buildings with the minimum amount of capital, like automobiles produced on an assembly line, without consideration of each culture and its sense of aesthetics. Hence, new elements in an unimaginatively constructed building often disappear, due to

---

<sup>93</sup> Rudolf Wienands, op.cit., p.105

soulless functionality. In other words, a building should also meet aesthetic expectations.

In this section, design principles of formal ordering for harmonious architecture will be treated in two ways by using the following principles, to give an outline of a new approach in applying traditional design theories to contemporary architecture; unity through similarity and ordered complexity.

---

### **3.3.1 Unity through Similarity**

Generally, specific differences in the design of a building can be observed more easily when we realise that there was a much greater connection between one or more other architectural components in earlier times; the limited use of other materials and tools brought about great uniformity and homogeneity with regard to form, material, or colour, which resulted in a strong relationship between all of the elements, and was the main basis for optimal design quality in earlier times. In other words, this limitation of materials and tools cemented the relationship between the architectural elements; most of the different elements were inevitably combined with each other; i.e. through similarity of colour, form, size or structure.

On the other hand, there has been criticism of current architecture; it is typical of our architectural period that buildings are being mass produced, much like boxes of matches, and that a grey concrete forest is being constructed. Through the development of various building materials and construction techniques, contemporary architects have the possibility of creating complex and rounded forms based on their creative ideas. This tendency causes a weak relationship between architectural elements in comparison to the past, and it results in isolation, over-individuality and confusion between

each building.

In order to solve the above-mentioned problems of current architectural design, it is useful to achieve “unity through similarity” of architectural elements, to harmonize the old- and new-buildings, utilizing the fact that the eye tends to group together things of the same type.<sup>94</sup> Unity denotes some harmony or agreement among the elements in a design, such as form, colour and texture. The aim of unity is to make the design coherent and “readable”.<sup>95</sup> For example, as shown in Fig.97, unity of size, indeed, even the comparative size of elements, is an effective factor grouping by similarity. As applied to architecture, when observing a building, which is seen as a whole relationship rather than simply a collection of unrelated elements through repetition and contrast, which are a composition principle of design, we can feel unity in this building.

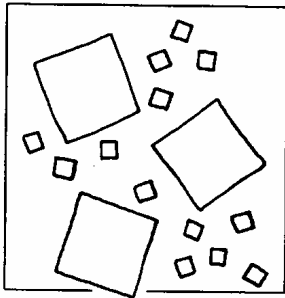

Fig.97 Group of large elements and group of small elements



Fig.98 View of an old city in Stockholm

As shown in Fig.98, this design technique can be easily found in old European cities; an order system in these old cities is achieved by unity through similarity of various architectural elements and details which differ in other ways, owing to the above-mentioned limitation of construction techniques and materials. Important design factors in architecture are generally divided into form, texture, colour, natural and artificial light.<sup>96</sup> In this section, unity is described with form, colour, texture and scale, because these are the first factors to which the eye reacts, when observing an architectural work. As seen in old European cities, unity, which is obtained by a close relationship between form, texture, colour and scale, is a useful design solution to some of the current architectural problems, including the fact that there is a non-mutual relationship. Therefore, the methods for achieving unity through similarity can be described as follows:

<sup>94</sup> Pierre von Meiss, *Elements of Architecture; From Form to Place*, E&FN Spon, London, 1990, p.32

<sup>95</sup> David A. Lauer, *op.cit.*, p.2

<sup>96</sup> See Jürgen Joedicke's book „Raum und Form in der Architektur“, Karl Krämmer Verlag, Stuttgart, 1985

- *Similarity of form, scale, proportion*
- *Similarity of materials and texture*
- *Similarity of colours*
- *Mutual harmony in each relationship*

---

### 3.3.1.1 Methods for achieving architectural harmony

Architecture is an art which relies on the mutual dependence between elements to establish coherence. There are various methods for achieving architectural harmony. Using the following four techniques, unity can reinforce and sometimes even replace formal coherence.

#### ① Similarity of form, scale and proportion

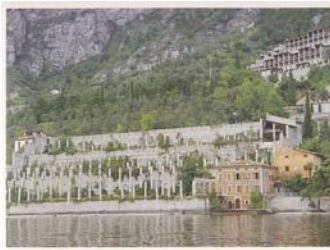

Fig.99 Similarity of form, scale and proportion

We can define the object of architectural proportion and scale as the creation of visible order by the repetition of similar forms. Unity in form, scale and proportion increases the quality of a design, connecting the old- and new-elements harmoniously. When the elements are heterogeneous, unity can be obtained through common characteristics, as for example the similar form of the windows, the size and proportion of these and their relationship to other elements.

In particular, the importance of similarity of form as a source of unity in design has seldom been denied. Obvious examples of this are the round arches and vaults of Roman and Romanesque architecture, and the pointed arches and vaults of Gothic architecture. Thus, unity can be imparted to a building by the repetition of one dominant form in a number of its parts.<sup>97</sup>

#### ② Similarity of materials and texture

Unity of materials and texture, called “homogeneous textural effect”, is an example of a design technique which reinforces the tendency towards coherence in spite of the individuality of

---

<sup>97</sup> P.H.Scholfield, op.cit., p.6



Fig.100 Richard Meier, Front Entrance of MACBA

each building. In the Museum of Contemporary Art (MACBA, 1992-1995) in Barcelona by Richard Meier, a white metal panel, white plaster and glass were used together to create a homogeneous textural unity. Although these materials have a slight difference in their texture, they still give people a sense of textural smoothness and unity, as shown in Fig.100.

### ③ Similarity of colour

Colour always dominates form.<sup>98</sup> This means that two or more of the same form can be regarded as other forms depending on the use of colour. Therefore, a theory is possible that a whole optimal quality of design can be achieved by using the fact that different elements such as building form, windows, doors and details are “welded” into one through similarity of colour.



Fig.101 Chaos between colours

Fig.101 shows that the interior design does not have unity, although the pieces of furniture are similarly grouped, so that the mood of the room is chaotic because the use of colours is not uniform. Fig.102 depicts a harmonious design that can be created by similarity of colours in spite of the various shapes of the furniture in this room.



Fig.102 Unity between colours

### ④ Mutual harmony of each relationship

As we can see from the preceding paragraphs, if architectural elements, such as roof, façade, window, door, material and colour which are expressed in a building or in buildings, are harmonized by the combination of similar form, scale, proportion, material, texture and colour, this similarity reflects the highest quality of design. On the other hand, too many similarities between these elements could cause a monotonous design. Furthermore, extravagant use of these, that is, too many forms, colours and materials, destroys their relationships and the quality of the design.

Therefore, an appropriate use of the afore-mentioned similarities is strongly recommended as the only effective

<sup>98</sup> Rudolf Wienands, op.cit., p.180

method for achieving harmonious unity of design.

---

### 3.3.1.2 Application of the theory of “Unity through Similarity”

This section presents examples of contemporary architecture, to which the “similarity theory” is both applied and unapplied, and evaluates the quality of these examples, in order to derive a synthetic sequence of this theory. The following groups of buildings are used to demonstrate the theory of “Unity of Similarity”.

#### ① Similarity between various forms

In building-groups of different forms, the effective use of similarity in scale, material and colour between each building is recommended for harmonious unity. Using this principle, the chaos to the eye caused by the various forms of the buildings can be reduced. As shown in Fig.103, this principle was followed faithfully when designing the New City Hall in Bensberg. The use of exposed concrete as the exterior material strengthens the close relationship between the surrounding buildings, which consist of bricks and natural stones. Simultaneously, complete harmony is achieved by the use of similar scale and colour in this building.

Fig.103 New City Hall in Bensberg, Germany



#### ② Similarity between various scales

As shown in the left-hand photo in Fig.104 which consists of a

large and small building, the similarity between the details – the construction of the walls, the wooden material, size and proportion of the windows – counterbalances the difference in size of the houses. Conversely, the right-hand photo in Fig.104 shows an inharmonious design, owing to the non-relationship between the two design elements. This non-relationship imparts not only individuality but also causes isolation of each building, as mentioned earlier.

Fig.104 Similarity between various scales



### ③ Similarity between various textures

The eye perceives texture when the individual parts of a surface are sufficiently close, similar and numerous that they are no longer seen as individual components and figures. Unity of materials and texture is another example of specific characteristics which can be used to reinforce coherence of a design, in spite of the individuality of each building. The easily optically-diffusible design caused by various textures, as in the right hand picture in Fig.105, is balanced by the similarity of form, size and colour, as in the left hand picture in Fig.105.

Fig.105 Similarity between various textures



### ④ Similarity between various colours

According to Joseph A. Gatto's book "Elements of Design, Colour and Value", colour has the power to interpret our environment. It provides an ever-changing source of visual and emotional stimulation in numerous aspects of our lives. For the architect, colour provides a means of expressing



feelings and the intangible, making possible the creation of a work of architecture. The left hand photo in Fig.106 is a good example of this, illustrating a harmonious balance between the different coloured building-groups, and is achieved by approximate but never identical similarity in form, scale and texture. However, the right hand photo in Fig.106 illustrates the opposite situation: in the variously coloured building groups, any close relationship to each other such as form, scale and texture can not be found.

Fig.106 Similarity between various colours



#### ⑤ Similarity between various conditions

Fig.107 shows both effective and poor use of similarity of colour and form to counterbalance the difference in scale and texture of the buildings. If the other conditions, for example form and texture or scale and texture and so on, differ from each other, a skilful combination of the remaining design factors can reinforce the close relationship between the other elements without breaking up the overall architectural harmony of the buildings.

Fig.107 Similarity between various conditions



In sum, the relationship between various similarities can be described as in Table 11:



Table 11 Fourteen types of relationships for achieving harmony within a group of buildings

The contrasting factor	Key factor for harmony
Form	Scale, Texture, Colour
Scale	Form, Texture, Colour
Texture	Form, Scale, Colour
Colour	Form, Scale, Colour
Form, Scale	Texture, Colour
Form, Texture	Scale, Colour
Form, Colour	Scale, Texture
Scale, Texture	Form, Colour
Scale, Colour	Form, Texture
Texture, Colour	Form, Scale
Form, Scale, Texture	Colour
Form, Scale, Colour	Texture
Form, Texture, Colour	Scale
Scale, Texture, Colour	Form

### 3.3.2 Ordered Complexity

Unity, variety and harmony are three of the typical elements which we associate with formal aesthetics.<sup>99</sup> As shown above in Section 3.3.1, the relationship between unity and harmony is described as the principle “Unity through Similarity”. This section will describe the other relationship of formal aesthetics between variety and harmony, using the principle “Ordered Complexity”.

Generally, complexity in architecture can be defined as being the opposite of simplicity, indeed of what is clear and elementary. Regular geometric order produced by simplicity sometimes has a bad reputation. One complains about uniformity, rigidity, monotony and inhumanity. In order to avoid these complaints, a design element “complexity” is needed to offer the visual interest and generate tension in an observer. With regard to this, Rapoport suggested that complexity is

<sup>99</sup> David Smith Capon, op.cit., p.60

necessary for mental stimulation, saying that “the design process trends towards simplicity, whereas people desire complexity”.<sup>100</sup> Le Corbusier also said of the importance of complexity in design that “if it is simplicity derived from great complexity and richness, all is well; but if it is only poverty that is expressed...nothing is gained”. At this point, the elements of complexity require a framework, to avoid monotony and to impart a sense of balanced tension at the same time; that is, ordered complexity.

---

### 3.3.2.1 Ordered Complexity through Deviation from Axis and Symmetry



Fig.108 View of the Willits House

This principle can be well illustrated using the example of Frank Lloyd Wright’s building. The Willits House is his first house in Prairie style and marks the full development of his wood frame and stucco system of construction. The ground floor plan of the Willits House consists of the entrance hall, living room, dining room and kitchen. The principal living areas are arranged symmetrically by the cruciform axes around the central fireplace, even down to the last detail. He used a cruciform plan with the interior space flowing around a central chimney core and extending outward onto covered verandas and open terraces. However, access is provided via small, intermittent spatial elements, not along the axis, but diagonally to it. The form of the rooms and the lines of access are therefore organized in different ways. This deviated axis suggests an approach route and the principal directions to each room.

---

<sup>100</sup> Rapoport A., *Design Methods in Architecture*, Lund Humphries, London, 1969, p.142

Fig.109 Access axis in the Willits House

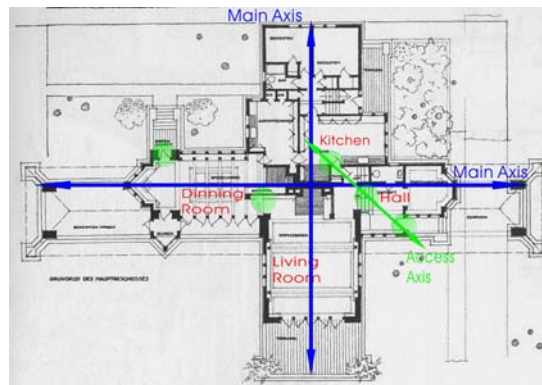
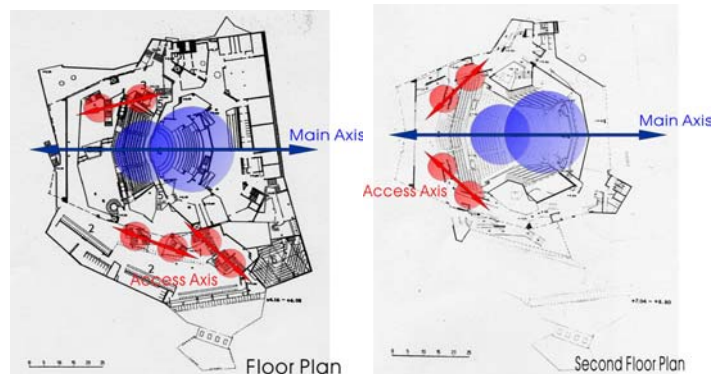

Fig.110 View of the Philharmonic Concert Hall, Berlin

Fig.111 Access Axis in the Philharmonic Concert Hall, Berlin

Even the apparently so manifold space of the Philharmonic Concert Hall in Berlin is arranged symmetrically about an axis; here again, access is not along the axis but via various entrances at different levels directly linked to the rising tier of seats. Furthermore, the axial symmetry is disrupted on both sides of the orchestra platform, as shown in Fig.111.



### 3.3.2.2 Ordered Complexity through Rhythm



Fig.112 Main façade of Farnese Palace, Rome

Ordered complexity can be applied to the façade of a building, through rhythm. The Farnese Palace in Rome, designed by Antonio da Sangallo and Michelangelo during the Renaissance, shows this principle clearly. Countless rectangles are organized in a coherent manner, with the pattern of the windows employing continuation both horizontally and vertically. The treatment of the pediment varies in each storey: sometimes flat, sometimes rounded, sometimes triangular, and, on the upper story, triangular

without a base. The central curved crest clearly becomes a focal point, leading the eye to the other arched doorway, which itself repeats the other, smaller curved elements. The façade is highly unified, the variety restrained and subtle. As a result, the building is dignified and imposing, its stateliness proclaimed immediately by its design.



Fig.113 View of the La Tourette

The monastery of Sainte Marie de La Tourette offers a solution to the question of ordered complexity through rhythm. In this building, irregular rhythms are superimposed over three storeys, and are brought to order by the near regular and heavily accented rhythm of the cell units marking the top of the building. In the vertical dimension, a rhythm is established by the relationship between the first three storeys and the projecting and contrasting top division.

Fig.114 Three components of rhythm in the La Tourette

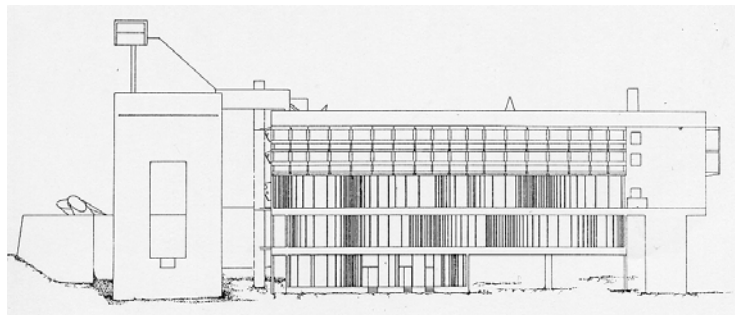

### 3.3.2.3 Ordered Complexity through Multi-Interpretation

The basic principle of ordered complexity through multi-interpretation can be illustrated by the example in Fig.115. The checkerboard design in the left hand figure has a unity based on use of proximity and constant repetition. But this can be very boring. The centre figure in Fig.115 in many ways resembles the left-hand checkerboard, but it seems not to be as boring as the left-hand one because of a bit of complexity in the frame of the grid. The right-hand figure is visually

interesting. This Fig.115 also resembles the checkerboard, but how much more interest comes from the application of ordered complexity. It has a unity the same as the left hand figure though the composition is very complex. The varying sizes and shapes of the rectangles, the placement of a few colored shapes, the delicate variations of vertical emphasis; all these serve to maintain the interest far longer than the checkerboard at left or at centre.

Fig.115 Complexity in checkerboard

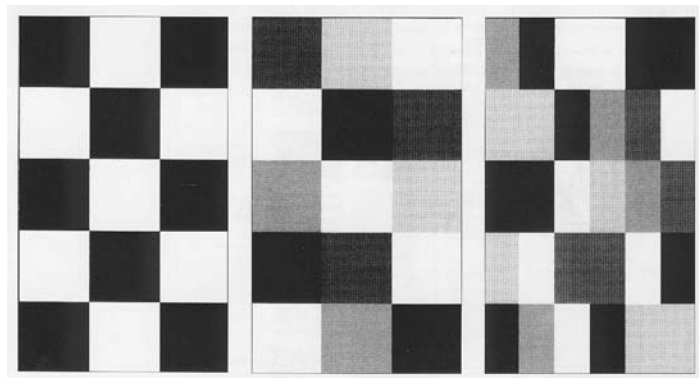

In the same way, we find ourselves in the presence of several coordinated and superimposed, similar formal structures in the façade for the funerary chapel of San Lorenzo in Florence, in spite of the symmetry, which is a powerful unifying factor. The elements are grouped in such a way as to present more than interpretation to the observer. This use of the ordered complexity principle makes the façade complex without being complicated.<sup>101</sup>

---

<sup>101</sup> Pierre von Meiss, op.cit., p.45

Fig.116 Complexity in San Lorenzo (Source : Pierre von Meiss)

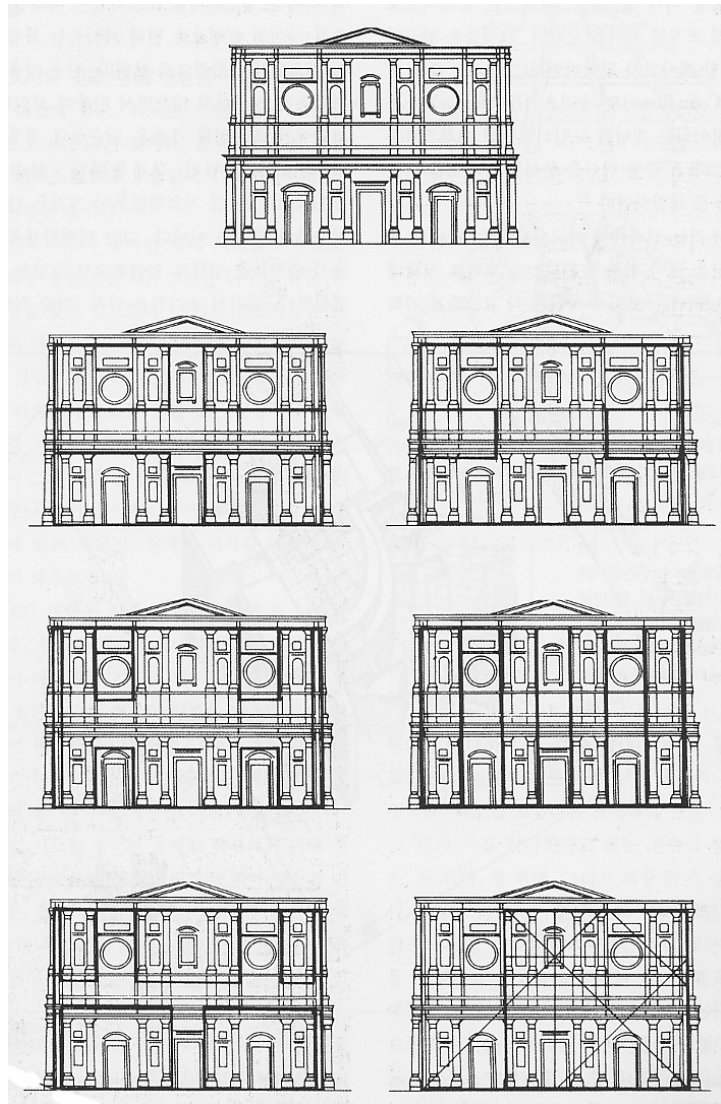

---

### 3.3.3 Summary

We have discussed a series of relationships concerned with “Unity through Similarity” and “Ordered Complexity”, and we have shown that they form the basis of harmonious quality of design.

Design is an activity that involves or seeks some degree of order. Order offers our eye satisfaction of balance and the power to create with ease unity standing out from the rest of the environment. However, people still need complexity, as

Rapoport mentioned above. At this point, complexity should play a role within the order framework so as not to cause chaos in a design. This approach is described as the creation of an ordered complexity; it can be also called “Unity within Complexity”. There are three ways in which ordered complexity relates to architecture:

- *Ordered complexity through deviation from axis and symmetry*
- *Ordered complexity through rhythm*
- *Ordered complexity through multi-interpretation*

This ordered complexity is no longer restricted to the just-mentioned principles, because order and complexity are twin poles of the same phenomenon and neither can exist without the other.

Therefore, it is recommended that both principles “Unity through Similarity” and “Ordered Complexity” are used together in a design to create a simultaneously ordered- and tensioned-architectural effect, complementing each others elements. This relationship is illustrated in the following Fig.117. Finally, the effective use of these principles results in an aesthetically pleasing design, linking the separate elements into a cohesive whole.

Fig.117 Relationship between the elements of formal aesthetics

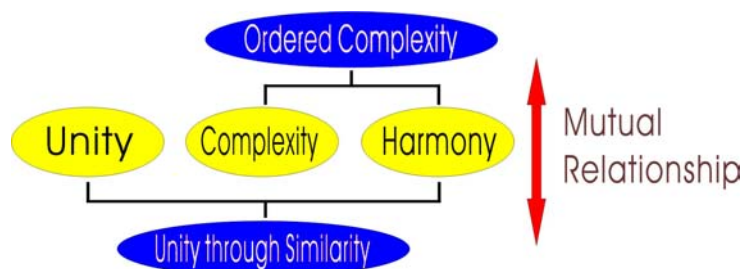

## 4. CHAPTER

# Information Modelling for Integration of Design Applications

It is widely accepted that the quality and efficiency of the design process in the AEC domain can be improved only through increasing automation of the design and construction process. The key to success in achieving automation is seen as the integration of the information processing required by the various disciplines involved at the various stages of the design process.

Currently, there are lots of projects concerned with producing conceptual modelling schema for the representation of design objects, for use in CAD. There are also product-modelling<sup>102</sup> efforts within the work on data exchange standards concerned with achieving product descriptions. As there are many different CAD systems and each CAD-software has its own internal description and storage of data, we encounter difficulties when we try to transfer design data from one CAD system to another. In order to solve these problems, studies have been conducted since the beginning of the 1980s. These studies use the neutral-format files such as IGES and DXF. As the next generation of IGES, the STEP (Standard for the Exchange of Product model data) is the international effort by ISO at trying to combine the different national activities in a single international standard.

This chapter presents an information model for integration of

---

<sup>102</sup> According to ISO (1994), a product information model or, for short, product model is defined as "an information model which provides an abstract definition of facts, concepts and instructions about a product".



the design model, which will be implemented in the AutoCAD environment, as shown in the following Chapter 5, using the neutral format language “EXPRESS”. This model has as its objective the development of theoretical foundations and methods of the design principles; e.g. aesthetic properties within the boundaries of STEP technology.

---

## 4.1 Information Modelling

---

### 4.1.1 What is an Information Model?

Information concerns knowledge, communication and data.<sup>103</sup> Raw data is not information. Two parties can only exchange data in conjunction with an agreement as to the meaning of the data. Consider the number “1964”. This number is data without information. The data becomes useful if we add the information that it is a year (1964), or the number of tissues used during an average head cold (1964). Although the data is the same in both cases, the information is different.

An information model is a formal description of types of ideas, facts and processes which together form a model of an area of interest in the real world and with which are provided an explicit set of rules for interpretation. Furthermore, it addresses the underlying meaning of data, regardless of technology.

Therefore, when two parties agree upon the meaning of an information model, they can map the model into a particular exchange of technology. For example, if two applications shared an information model for years, they might transmit the data describing the year 1964 as the 32-bit integer “0x000007AC”, as the IEEE 764 single precision floating point number “0x44F58000”, or as the ASCII string “0x31 0x39

---

<sup>103</sup> D.Schenck and P.Wilson, Information Modelling – The EXPRESS Way, Oxford University Press, New York, 1994, p.6

0x36 0x34". Each of these examples uses a different data exchange technology, but they all correspond to the same information model. The EXPRESS language is used to describe technology independent of information models and is designed to represent these models in a formal manner.

#### 4.1.2 Methods of Information Exchange

There are two main methods of transferring product data between dissimilar systems. One is by direct translation and the other is through the use of neutral formats.

The mechanism in the neutral format is that a pre-processor translates the CAD database into the neutral format and a post-processor translates the neutral format into the CAD database. Thus, when two dissimilar systems exchange data, there are two distinct translation phases; the neutral file method requires fewer translators. The number of processors is formulated as  $n*(n-1)$ , when information-exchange is conducted without the standard neutral format;  $n$  is the number of different systems. The number of these is formulated as  $2*n$  in the case of a neutral format system.

The arrows between CAD's illustrate the process in Fig.118.

Fig.118 Three kinds of data exchange

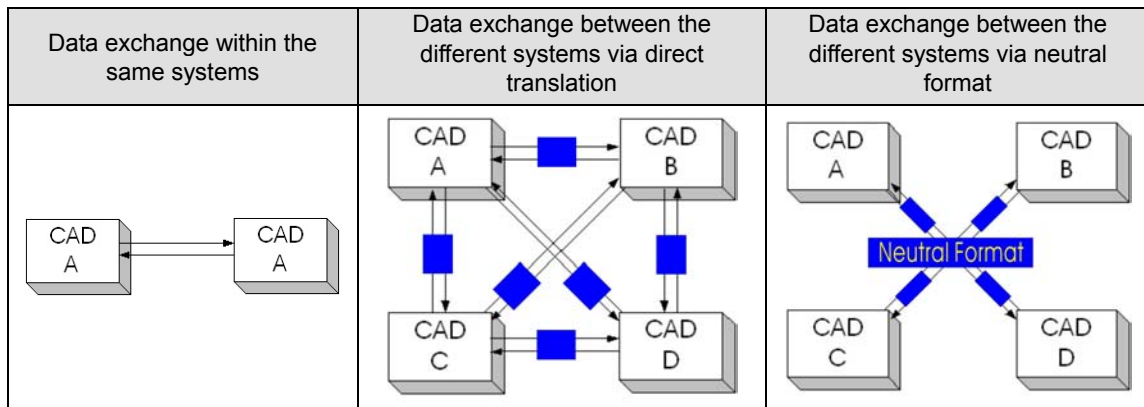

---

### 4.1.3 Information Model Format

The five contenders for exchange file neutral formats of an information model are the following:

- Drawing eXchange Format (DXF)
- Initial Graphics Exchange Specification (IGES)
- Standard d'Echange et de Transfert (SET)
- Verband Der Automobile – Industrie – Flächen Schnittstelle (VDA-FS)
- Standard for the Exchange of Product model data (STEP)

**DXF** is an Autodesk proprietary format that has been adopted by the construction industry. It is lightweight and only suitable for transferring simple drawings and then only if it is the highest common exchange factor linking the systems. It is not suitable for transferring partial geometry because of its lack of precision, even though it now offers 3D wire-frame geometry support. It does not have the weight of a National or International Standards Agency behind it nor is it incorporated into CALS. It is recommended only for use when exchanging data with AutoCAD; however, AutoCAD Release 14. has an extremely good IGES processor. For these reasons, it is not a suitable choice as a format to use for quality controlled data exchange between dissimilar systems.

**IGES** has been evolving for over twenty years and has become a reliable and widely used format. This is an American national standard ANSI Y14.26M. However, it does have serious limitations. It is restricted to partial geometry and annotation but does include structure and relationships. The other problem is that the IGES processor implementers, who are generally the CAD vendors, will normally only offer support for their own particular entities. Thus, it is possible for two exchanging systems to have an entity mismatch which is not the fault of IGES but of the particular implementations.

Fig.119 Example of IGES file

```

IGES file generated from an AutoCAD drawing by the IGES          S0000001
translator from Autodesk, Inc., translator version IGESOUT-3.04. S0000002
,,18HI:\LABOR\IGES\TEIL,23HI:\LABOR\IGES\TEIL.IGS,28HAutoCAD-12_c1a IntG0000001
ernational,12HIGESOUT-3.04,32,38,6,99,15,18HI:\LABOR\IGES\TEIL,1.0,1,4HIG0000002
NCH,32767,3.2767D1,13H961125.105316,2.0D-7,200.0,6HLS IIT,12H BTU CottbuG0000003
s,6,0; G0000004
110 1 1 1 00000000D0000001
110 1 1 1 1 D0000002
110 2 1 1 00000000D0000003
110 2 1 1 2 D0000004
110 3 1 1 00000000D0000005
110 3 1 1 3 D0000006
100 4 1 1 0 00000000D0000007
100 4 1 1 4 D0000008
100 5 1 1 0 00000000D0000009
100 5 1 1 5 D0000010
110,0.0,150.0,0.0,0.0,0.0,0.0; 1P0000001
110,0.0,0.0,0.0,100.0,0.0,0.0; 3P0000002
110,100.0,0.0,0.0,100.0,150.0,0.0; 5P0000003
100,0.0,50.0,150.0,100.0,150.0,0.0,150.0; 7P0000004
100,0.0,50.0,100.0,70.0,100.0,70.0,100.0; 9P0000005
S0000002G0000004D0000010P0000005 T0000001
    
```

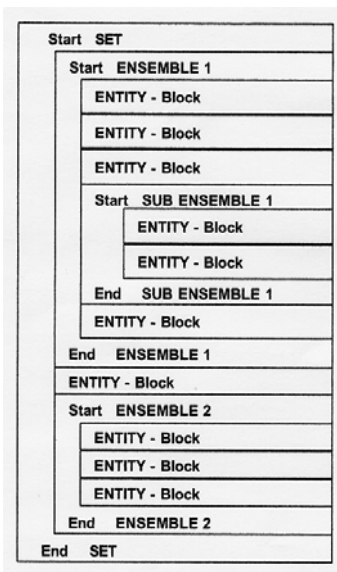

Fig.120 Example of SET file

**SET** was issued in the early 1980s as a competitor to IGES and is French national standard AFNOR z68300. It is concise and results in a smaller file size than the equivalent IGES file. However, IGES had a several year start on SET and was being fairly widely supported at the time of SET's birth and so SET never found much support outside of French CAD suppliers; e.g. it is one of the agreed exchange formats used in the Airbus Programme.

**VDA-FS** is a very concise format for 3D wire frame and surface geometry only. It was developed for use by the German automotive industry and has been adopted as German standard DIN 66301. It is quite widely used and within its scope is more efficient than IGES. It is worth nothing that the German automotive industry takes a leading role in the development of standards and it is the ProSTEP consortium that has been responsible for STEP AP214.

**STEP** has the great authority of the International Standards Organization behind it and is otherwise known as ISO 10303; it has made good all the shortfalls of IGES. It has its own data description language, EXPRESS, in which STEP is itself written.

The efforts of the national standardization for the information model are shown in Table12:

Table 12 History of the national standardization of information exchange formats

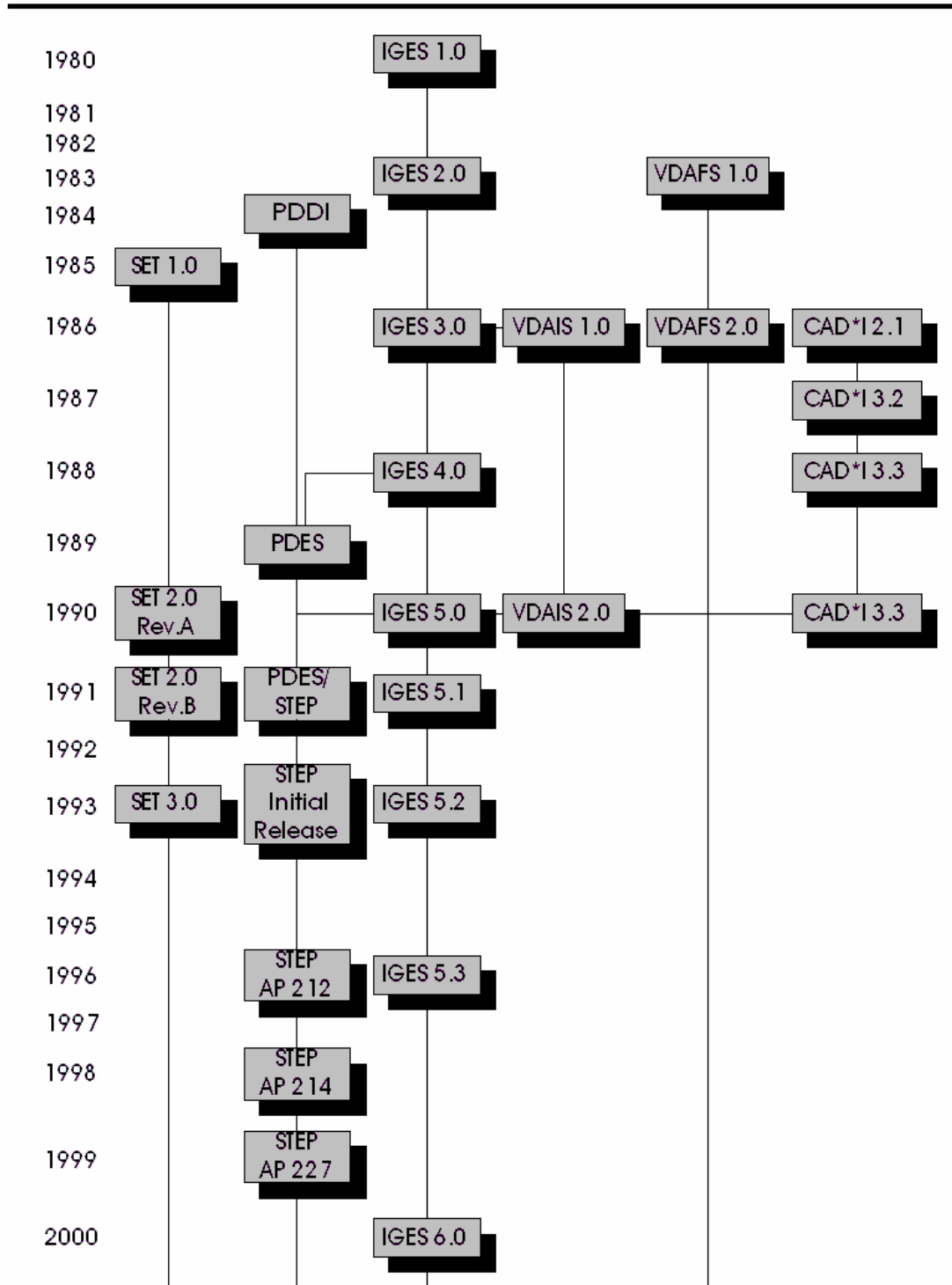

---

## 4.2 Standard for the Exchange of Product Model Data (STEP) as the Basic Integrated Information Model

Communicating information related to industrial products – a task achieved by exchanging products between computer systems – is nowadays an important precondition for a company to be successful.<sup>104</sup> To ensure the transfer of data containing high-level semantic information, without loss of information, generally acknowledged conventions are needed such as those contained in the international standard STEP. It defines specifications for the representation and exchange of digital product information.

STEP was born in December of 1983, when the International Standards Organization (ISO) formed the TC184/SC4 committee.<sup>105</sup> It is targeted at the exchange of data describing a product between Computer Aided X (X = CAD, CAM, CAE, ... etc.) systems, and also long term retention of such data. Specifically, the exchangeable product data is defined in the Application Protocols. EXPRESS is the language used within STEP to formally define the semantics of the data.

If engineering organizations can share data using STEP, then suppliers are no longer constrained to own and operate the same systems as their customers. The potential benefit is great. Suppliers are spending a lot of money buying the systems of their customers, more money training people to use those systems, and even more money re-entering data from their preferred systems into the system required by each customer.

---

### 4.2.1 Structure of STEP

---

<sup>104</sup> Felix Jakob Metzger, *Produckdaten-Design und Daten-integration durch Zusammenfügen autonomer Schema-Module*, ETH-Diss., Zürich, 1997.

<sup>105</sup> <http://www.steptools.com/projects/niiip/> (2003)

STEP standard is divided into many parts. These parts can be divided into Description Methods, Information Models, Application Protocols, Implementation Methods and Conformance Tools. The infrastructure parts, such as the Description Method (EXPRESS) and Implementation Method (file and programming interface), have been separated from the industry-specific parts (application protocols). Most of the infrastructure is complete, but the industry-specific parts are open-ended. Application protocols are available for mechanical and electrical products, and are under construction for composite materials, sheet metal dies, automotive design and manufacturing, shipbuilding, the AEC industry, processing plants, and others. In sum, STEP is structured as follows:

- *Part 1 (Overview)*
- *Parts 11-13 (EXPRESS)*
- *Parts 21-26 : Method definition such as SDAI, SPF, C++ and Java*
- *Parts 31-35 (Conformance testing methodology and framework)*
- *Parts 41-49 (Integrated generic information models)*
- *Parts 101-106 (Application Resource)*
- *Parts 201-233 (Application Protocols)*

---

#### **4.2.2 STEP Information Model**

STEP is based on information models. These models concentrate the standardization efforts on information content, rather than on implementation technology. This insures that efforts involved in developing the standard will not be discarded upon a change in computing technology.

There are three classes of STEP information models:

- *Application Protocols (AP's)*
- *Integrated Resources (IR's)*
- *Application Integrated Constructs (AIC's)*

The Application Protocols are industry-specific information models for exchanging data about activities in the life cycle of a product. These protocols are built from general information models called Integrated Resources. The Application Integrated Constructs are important when using data defined by several AP's.

### ① **Application Protocols (AP's)**

The STEP application protocols are designated as the 200-series documents. A list of current AP's are shown below:

Table13 List of AP's

<i>Part 201</i>	<i>Explicit Draughting</i>
<i>Part 202</i>	<i>Associative Draughting</i>
<i>Part 203</i>	<i>Configuration Controlled Design</i>
<i>Part 204</i>	<i>Mechanical Design Using Boundary Representation</i>
<i>Part 205</i>	<i>Mechanical Design Using Surface Representation</i>
<i>Part 206</i>	<i>Mechanical Design Using Wireframe Representation</i>
<i>Part 207</i>	<i>Sheet Metal Dies and Blocks</i>
<i>Part 208</i>	<i>Life Cycle Product Change Process</i>
<i>Part 209</i>	<i>Design Through Analysis of Composite and Metallic Structures</i>
<i>Part 210</i>	<i>Electronic Printed Circuit Assembly, Design and Manufacturing</i>
<i>Part 211</i>	<i>Electronic Test Diagnostics and Remanufacture</i>
<i>Part 212</i>	<i>Electro-technical Plants</i>
<i>Part 213</i>	<i>Numerical Control Process Plans for Machined Parts</i>
<i>Part 214</i>	<i>Core Data for Automotive Mechanical Design Processes</i>



<i>Part 215</i>	<i>Ship Arrangement</i>
<i>Part 216</i>	<i>Ship Moulded Forms</i>
<i>Part 217</i>	<i>Ship Piping</i>
<i>Part 218</i>	<i>Ship Structures</i>
<i>Part 219</i>	<i>Dimensional Inspection Process Planning for CMMs</i>
<i>Part 220</i>	<i>Printed Circuit Assembly Manufacturing Planning</i>
<i>Part 221</i>	<i>Functional Data and Schematic Representation for Process Plans</i>
<i>Part 222</i>	<i>Design Engineering to Manufacturing for Composite Structures</i>
<i>Part 223</i>	<i>Exchange of Design and Manufacturing DPD for Composites</i>
<i>Part 224</i>	<i>Mechanical Product Definition for Process Planning</i>
<i>Part 225</i>	<i>Structural Building Elements Using Explicit Shape Representations</i>
<i>Part 226</i>	<i>Shipbuilding Mechanical Systems</i>
<i>Part 228</i>	<i>Building Services: Heating, Ventilating and Air Conditioning (HVAC)</i>
<i>Part 230</i>	<i>Building Structural Frames: Steelwork</i>

Each AP covers a portion of a product lifecycle. For example, AP's 202 through 209 deal with aspects of the design and analysis of mechanical parts. AP-214 further narrows down this scope to automotive parts. AP-225, -228 and -230 are concerned with the architectural field. Application protocols can also be developed outside of the standards community.

Basically, the definition of an application protocol consists of two parts. The first part is an application reference model (ARM), which defines the necessary concepts for the application domain to be covered by the application protocol. This model is concise and describes requirements in terms of basic Application Objects that a user of the AP information would be concerned with. The application objects can be described by NIAM, IDEF1X, or EXPRESS-G diagrams.

The second part of an application protocol is an application interpreted model (AIM), which shows how the application reference model is implemented with the integrated resources. This AIM gives an interpretation to entities defined in the integrated resources and is always described with EXPRESS. Finally, components of an application protocol are summarized in the following Table 14:

Table 14 Description of AP's

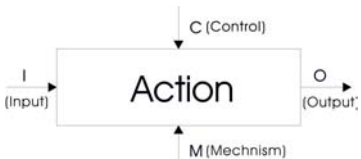
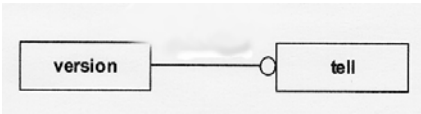
Model	Task	Means of description
AAM (Application Activity Model)	Description of the functionality of the information processing solution for which the application model becomes specialized.	SADT-Method (IDEF0) 
ARM (Application Reference Model)	Description of the information processing solution from the user's view	EXPRESS-G, EXPRESS, IDEF1X, NIAM 
AIM (Application Interpreted Model)	Result of the illustration of the ARM on the STEP main model (Resource Models). The AIM is the basis for implementation and is itself independent, however, of implementation.	EXPRESS, EXPRESS-G <pre>ENTITY product_version;   id:identifier;   description: text;   of_product: product; END_ENTITY; ENTITY product   id:identifier;   name: label;   description: text; END_ENTITY;</pre>

## ② Integrated Resources (IR's)

The Integrated Resources (IR's) are the heart of STEP. These conceptual schemas describe an integrated product model for all AP's. There are two types of IRs. Generic integrated resources (40-series documents) describe very general characteristics of products across all industries. The application-integrated resources (100-series documents) refine the integrated resources down to the needs of a particular industry. A list of current IR's is shown below.

Table 15 List of IR's

<i>Part 41</i>	<i>Product Description and Support</i>
<i>Part 42</i>	<i>Geometric and Topological Representation</i>
<i>Part 43</i>	<i>Representation Structures</i>
<i>Part 44</i>	<i>Product Structure Configuration</i>
<i>Part 45</i>	<i>Materials</i>
<i>Part 46</i>	<i>Visual Presentation</i>
<i>Part 47</i>	<i>Shape Tolerances</i>
<i>Part 48</i>	<i>Form Features</i>
<i>Part 49</i>	<i>Process Structure and Properties</i>
<i>Part 101</i>	<i>Draughting Resources</i>
<i>Part 102</i>	<i>Ship Structures</i>
<i>Part 103</i>	<i>Electrical/Electronics Connectivity</i>
<i>Part 104</i>	<i>Finite Element Analysis</i>
<i>Part 105</i>	<i>Kinematics</i>

### ③ Application Integrated Constructs (AIC's)

STEP introduced a construct for describing the interoperable segments of definitions shared by multiple AP's. The constructs, called Application Integrated Constructs (AIC's), are sets of refined definitions that must be used as a single unit, without any additional refinement.

### ④ STEP Physical File Exchange

STEP defines a number of implementation methods of exchanging and manipulating information described by application protocols. The first implementation method was a straightforward ASCII file format for exchanging EXPRESS-defined data sets. This exchange file format is Part 21 of the standard. The DATA section of a file contains entity instances. Each instance has an integer identifier. These #nnn numbers are used to refer to objects within the file. These numbers are unique within a file, but need not be preserved over time. Entity instances are normally written using an "internal mapping" where the name of the entity type is followed by a list of attributes in superclass-to-subclass order.

As a very simple example, consider the following schema:

*SCHEMA residences;*

*ENTITY person;*

*Name : STRING;*

*Hometown : town;*

*END\_ENTITY;*

*ENTITY town;*

*Name : STRING;*

*Country : STRING;*

*INVERSE*

*Citizens : SET OF person FOR hometown;*

*END\_ENTITY;*

A physical file with a couple of instances of these entities could look as follows:

*ISO-10303-21;*

*HEADER;*

*FILE\_DESCRIPTION(...);*

*FILE\_NAME(...);*

*FILE\_SCHEMA(('residences'));*

*ENDSEC;*

*DATA;*

*#1 = TOWN('Daegu', 'Republic of Korea');*

*#2 = TOWN('Munich', 'Germany');*

*#3 = PERSON ('Choo', #1);*

*#4 = PERSON ('Junge', #2);*

*ENDSEC;*

*END-ISO-10303-21;*

---

### 4.3 EXPRESS

As mentioned above, an information model is an agreement on the meaning of data and addresses the underlying meaning of data regardless of technology. Early CAD standards, such as IGES, usually focussed on data exchange without a formal description of the underlying information model. EXPRESS has been designed to represent these information models in a formal manner. It is a formal language for specifying information requirements. The EXPRESS language is defined by ISO TC184/SC4 and published as ISO 10303-11. It has been used by STEP, POSC, DICE, CFI and other projects to describe the information requirements of many engineering activities. This language has been an international standard since September 1994.

EXPRESS consists of language elements that permit unambiguous data definition and specification of constraints on the data defined. This language is readable to humans and fully computer-interpretable. We must note that EXPRESS is not a programming language. However, ISO10303 has defined straightforward implementation forms.

EXPRESS has several strengths:

- *The language can be used to describe constraints as well as data structures and relationships. These constraints form an explicit correctness standard for an information model.*
- *EXPRESS models are computer processable; hence, software is able to take advantage of the definitions without human transcription.*
- *EXPRESS has undergone the international standardization process, which represents a significant consensus that the language meets the needs of industry.*

---

### 4.3.1 History of EXPRESS

The history of EXPRESS began in 1982. The Product Data Definition Interface (PDDI) project was founded in 1982 to specify an interface between design and manufacturing for product definitions.<sup>106</sup> During this project, Douglas Schenck at McDonnell Douglas developed a data definition language called DSL.<sup>107</sup> This language was the basis for EXPRESS.

In December of 1983, the International Standards Committee began work on the Standard for the Exchange of Product Model Data (STEP). At the time, IDEF1X, NIAM, and Entity-Relationship diagrams were in wide use for modelling. Lexical model language such as SQL, DAPLEX, and GEM were also available.<sup>108</sup> IDEF1X and NIAM proved unacceptable for several reasons, because these languages were developed to present information only to people. It was decided that STEP needed a language that could be processed by machines as well as people to facilitate data exchange. Therefore, a new language named EXPRESS was developed in 1986. This language has a lexical form that can be compiled by machines and a graphical form that can be understood by people.<sup>109</sup>

---

### 4.3.2 EXPRESS Dialects

EXPRESS itself is an object-flavoured lexical language for information modelling. The EXPRESS Language Reference Manual also defines a graphical subset of the lexical language called EXPRESS-G. It is used to identify classes, the data attributes of classes and the relationships that exist between classes. EXPRESS-G is directly related to the EXPRESS data

---

<sup>106</sup> P.R. Wilson, A Short History of CAD Data Transfer Standard, IEEE Computer Graphics and Applications, Vol.7, No.6, June 1987, p.p.64-67.

<sup>107</sup> D.Schenck and P.Wilson, op.cit., p.25

<sup>108</sup> David Thomas Loffredo, op.cit., p.10

<sup>109</sup> <http://www.steptools.com/projects/niiip/> (2002)

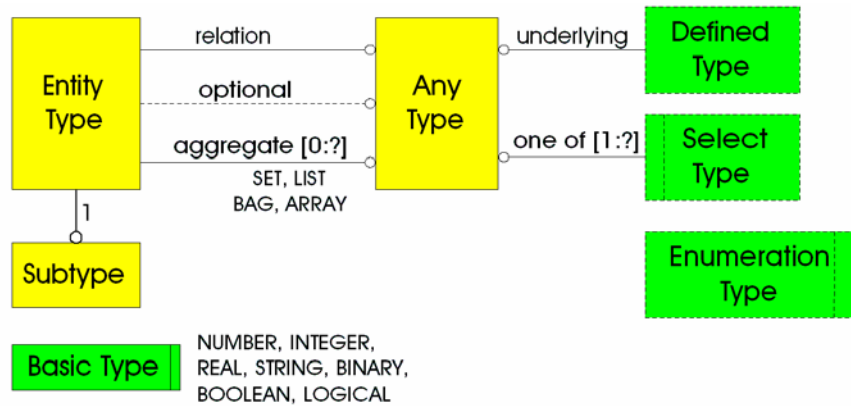

Fig.121 EXPRESS and EXPRESS-G relationship

definition language. That is, everything that is drawn in EXPRESS-G can be defined in EXPRESS.

However, not everything that can be defined in EXPRESS can be drawn in EXPRESS-G. This relationship is shown in Fig.121. An overview of data types and relationships used in the EXPRESS-G notation can be seen in Fig.122:

Fig.122 Overview of the EXPRESS-G notation



This section provides a basic description of the EXPRESS-G notation as used in specifying IFC's, outlining the meaning and using the various symbols. It is provided for information and to assist readers in understanding the graphical models used for specifying IFC's.

The third member of the family is called EXPRESS-I and is a lexical language for the display of data instances and also for the formal definition of test cases. A fourth member of the family, called EXPRESS-X, is in preparation as a mapping language for data translation between two EXPRESS models that are similar in semantic meaning but which differ in their data forms.<sup>110</sup> EXPRESS-X is defined as specifying mapping of information that is modelled in the EXPRESS language. Mapping is the specification of how to convert a data set described by the EXPRESS schema (source schema) to

<sup>110</sup> Peter R. Wilson, STEP and EXPRESS in the website <http://deslab.mit.edu/DesignLab/dicpm/step.html> (2002)

another structure described by another EXPRESS schema (target schema). The first EXPRESS-X specification was due mid 1996. This language combined the two language EXPRESS-M(ap) (ISO TC184/SC4/WG5 N243) and EXPRESS-V(iew) (ISO TC184/SC4/WG5 N251). It is very useful for the compiling and the interpreting of data because the hard coding of convert software is avoided and its structure is similar to that of the EXPRESS language.

Table 16 EXPRESS dialects within ISO10303

Kinds of the EXPRESS Dialects	Description
EXPRESS (ISO10303-11)	Textual, complete notation
EXPRESS-G (ISO10303-11)	Graphical, partial notation
EXPRESS-I (ISO10303-11)	Instantiation language
EXPRESS-X (ISO10303-11)	Mapping and viewing language

### 4.3.3 EXPRESS Language Concepts

The function of EXPRESS is to describe information requirements and correctness conditions necessary for meaningful data exchange. EXPRESS is not an implementation language like C++ or a functional interface description language like CORBA/IDL. An EXPRESS information model is organized into schemata. These schemata contain the model definitions and serve as a scoping mechanism for subdividing large information models. Within each schema are three categories of definitions<sup>111</sup>:

- *Entity Definitions: Entity definitions describe classes of real-world objects with associated properties. The properties are called attributes and can be simple values, such as "name" or "length", or relationships between*

<sup>111</sup> For a complete understanding and treatment of this, the reader is encouraged to refer to "Information Modeling the EXPRESS Way" by D.Schenck and P.Wilson.



*instances, such as “owner” or “part of”. Entities can also be organized into classification hierarchies, and inherit attributes from supertypes. The inheritance model supports single and multiple inheritance, as well as a new type, called AND/OR inheritance.*

- *Type Definitions: Type definitions describe ranges of possible values. The language provides several built-in types, and a modeller can construct new types using the built-in types, generalizations of several types, and aggregates of values.*
- *Correctness Rules: A crucial component of entity and type definitions are local correctness rules. These local rules constrain relationships between entity instances or define the range of values allowed for a defined type. Global rules can also make statements about an entire information base.*
- *Algorithmic Definition: An information modeller may define functions and procedures to assist in the algorithmic description of constraints.*

---

#### **4.3.4 Application of EXPRESS in Other Standards**

EXPRESS is used in other standards, such as EDIF for electronic printed wiring boards, ISO TC 211 for Geographic Information Systems, and will be used in forthcoming editions of the SGML and XML standards. It has found broad applications within industry, such as POSC (Petrotechnical Open Software Corporation) for modelling oilfield exploration and production information, the Human Genome Project for data exchange between genomic databases, and the London Stock Exchange for Asset Management. Many European ESPRIT Projects use EXPRESS. The Swedish Defence Material Administration book describes some of these, as well as describing its use within a CALS environment. US projects and industrial consortia that use EXPRESS include, among

others, the CAD Framework Initiative (CFI) and the National Industrial Information Infrastructure Protocols (NIIP) project.<sup>112</sup>

---

## 4.4 Industry Foundation Classes (IFC)

---

### 4.4.1 Background and Structure of IFC

IFC (Industry Foundation Classes) is an information standard for the building industry, encompassing AEC/FM<sup>113</sup> domains. This standard is being developed by IAI (International Alliance for Interoperability) whose mission is to define, publish and promote specifications for IFC as a basis for project information sharing in the building industry.<sup>114</sup>

The IFC concept is based on the idea that objects are brought into an integrated model. These objects are defined in order to support the whole lifecycle of facility development from inception through design, documentation and construction, then facility management and finally to demolition and or disposal. The principal benefit of IFC's is their object description – not only does the IFC protocol preserve the full geometric description in 3D, but it also knows its location and relationships, as well as all the properties or parameters of each object such as finish, serial number, material description, etc. For instance, in the ArchiCAD environment, as shown in Fig.123, IFC is to “Project Model” exchange (wall, door, window) what DXF is to graphic entity exchange (line, arc, circle).<sup>115</sup>

---

<sup>112</sup> Peter R. Wilson, STEP and EXPRESS in <http://deslab.mit.edu/DesignLab/dicpm/step.html>. (2002)

<sup>113</sup> AEC/FM stands for Architecture, Engineering, Construction and Facility Management.

<sup>114</sup> Since 1995, the North American Chapter of the IAI, has worked to develop and promote the use of global standards for the automated exchange of data among computer applications.

<sup>115</sup> ArchiCAD, ArchiCAD IFC Reference Guide – version 1.0, Graphisoft R&D, 2001, p.3

Fig.123 Evolution of 2D graphics into object integrated models  
(Source: ArchiCAD Reference)

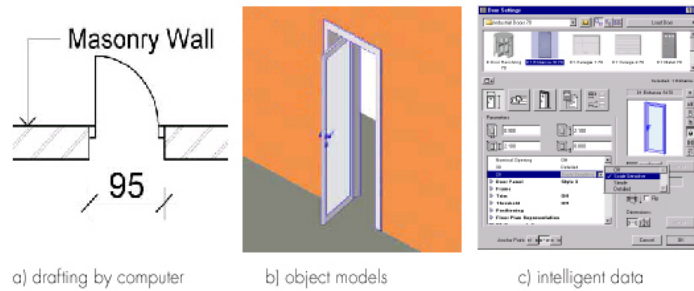

This means that information such as ID, name, geometry, relationship and other attributes is attached to an object. Therefore, a door is not simply a collection of points, lines, and curves arranged to look like a door in this environment – it is an object, with an object-orientated infrastructure, that displays many of the qualities and much of the behaviour of a real door within the context of the information model.

The IFC model uses EXPRESS as data definition language and is also available in a graphical representation, EXPRESS-G, which is readily accessible and easily understandable. The graphical representation is the best starting point for exploring the IFC model. It is hyper-linked to definitions of the terms and objects.<sup>116</sup>

Part 11 of STEP, and the ISO EXPRESS language (STEP-11) have been adopted by IFC to describe its model. Thus, the IFC data model corresponds with the STEP standard and consequently contributes to the evolution that permits the exchange of building data between different programmes.

Unlike STEP, evolution is not planned for a norm, but aims at direct application in the industry. For example, the IFC has a much broader scope than AP 225 of the STEP. The current release (IFC2x) is focussed on the design stages, but there is already support for facility management, and future releases will include thermal analysis etc. A subset of IFC2.0 is shown in Fig.124. It illustrates some of the entity definitions and relationships related to building elements, such as the

<sup>116</sup> Francois Grobler, Access to the Public Industry Foundation Classes Model in the website <http://www.cecer.army.mil/EARUpdate/NLFiles/2000/IFC.cfm>

decomposition structure, sub-types and associations with other objects.

Fig.124 An interpretation of IFC2.0, showing a subset with focus on the IfcBuildingElement

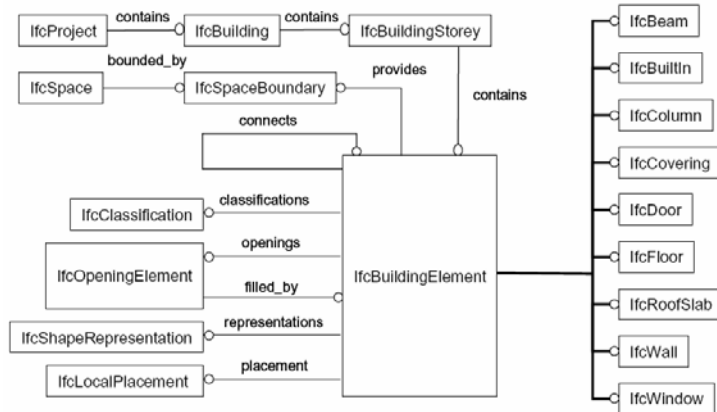

IFC takes as its starting point the units of EXPRESS to define IFC Meta Model which consists of IfcObject, IfcRelationship and IfcPropertyDefinition.

These basic objects are specialised into classes, such as IfcProduct, IfcProcess and IfcControl, and different relations, such as IfcRelContains and IfcRelGroups. At this level, fundamental functions, such as position, relationship between elements, process stage and grouping of objects, are defined. The next level is the Core Extension Layer, which consists of specialisations of the Core classes. For example, IfcProductExtension defines basic objects, such as IfcElement, IfcSpace and IfcBuilding.

The last level is called the Interoperability Layer, which holds classes to different actors and disciplines, consisting of IfcWall, IfcBeam and IfcElectricalAppliance. At this level, specialised extensions for separate disciplines are found.

Central to the IFC is a core model that defines and relates the key concepts of the standard. The purpose of IFC is to establish a common way of describing data for different applications, both with regard to conceptual content, terminology and exchange format; that is, to achieve interoperability, i.e. information transfer without information loss and without the need for intermediary human

interpretation.

Fig.125 Modules within the IFC Architecture

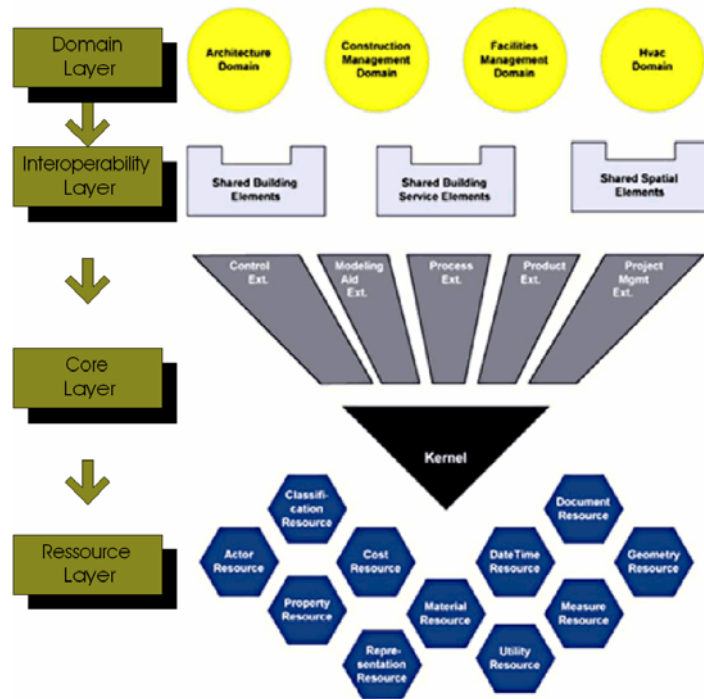

Many of the actual leading CAD software-vendors, for instance AutoDesk, Graphisoft, Nemetschek, etc., support importing and exporting IFC compliant data. While a new version has been available since October 2000, IFC2x, it is not yet commercially supported by any CAD software.

#### 4.4.2 IFC Releases History<sup>117</sup>

The IFC model is the culmination of over a decade of research and development. The model has undergone four major releases:

##### IFC Release 1.0

Release 1.0 of the IFC Specifications began the incremental

<sup>117</sup> Jeffrey Wix, Industry Foundation Classes Release 2.0 – An introduction to the International Alliance for Interoperability and the Industry Foundation Classes, IAI, 1999, p.p.18-19

definition of a shared project model used throughout an AEC/FM project life cycle. The initial release included models supporting some processes in architectural design, HVAC engineering design, facilities management, and cost estimating. The resulting integrated model represented only a fraction of the scope of definition of a complete, shared-project model. However, these were identified as critical to the first incremental release of the IFC Specifications.

### **IFC Release 1.5**

Release 1.5 of the IFC Specifications did not extend the domain coverage beyond that which was developed for Release 1.0. However, building on the implementation experience of Release 1.0, the IFC Technical Architecture was improved and the Core of the IFC Object Model extended and stabilized to provide a platform for commercial software development.

#### **IFC Release 1.5.1**

Resulting from trials of the Release 1.5 model, an update was issued to resolve implementation problems. The opportunity was also taken to improve core and resource elements of the model.

### **IFC Release 2.0**

Release 2.0 extends the domain coverage of the IFC Object Model and includes the domain processes identified below. Key parts of the Core and Resource models remain unchanged although some additional features have been added to support new domain processes.

Fig.126 New processes In Release 2.0

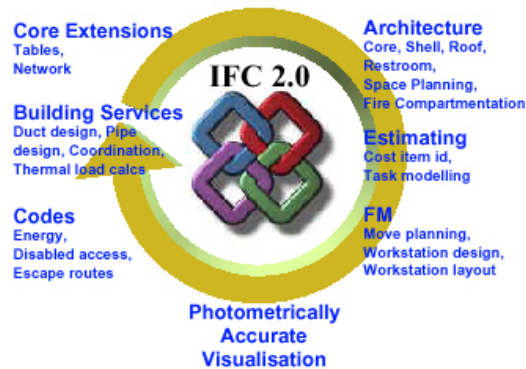

### IFC Release 3.0

It is intended that Release 3.0 will significantly extend the domain coverage of the IFC Object Model. The proposals are identified in Fig.127.

Fig.127 New processes in Release 3.0



#### 4.4.3 Modern Perspective of IFC

The IFC class hierarchy covers the core project information such as building elements, the geometry and material properties of building products, product costs, schedules, and organization. Instances of the IFC are initialized, linked, and assembled by application software to create an object model of the building project. Generally, the information from many types of computer applications can be mapped into an IFC data file. In this way, IFC provides a standard data model and a neutral file format that enables applications to efficiently

share and exchange project information.

The development of standard-based product and process data models to support the life cycle activities in the AEC industry has been addressed intensively during the last decade. Amor<sup>118</sup> and Eastman<sup>119</sup> have reviewed a long list of recent research initiatives addressing the standard-based model issue. In particular, several data models for AEC objects were proposed. Examples include GARM, PISA, ATLAS, COMBINE, RATAS, OPIS, ICON, COMBI and VEGA. Using the IFC data model could significantly improve the availability and consistency of project information, and would serve to integrate the multi-disciplinary aspects of the projects and facilitate the exchange of project information between function-specific software tools. As a result, this would minimize the need for human intervention to re-interpret and re-format the data, to marshal it between various tools, and thus eliminate the possibility of errors during data transformation.

Finally, IFC will play a very important role as a common framework, which will be a good basis for harmonization in the AEC/FM domain.

---

<sup>118</sup> Amor R., A UK survey of integrated project databases, Proceedings of CIB W78 Information Technology in Construction Conference, 1998, Stockholm, Sweden, p.p.67-75

<sup>119</sup> Eastman C. and G. Augenbroe, Product modelling strategies for today and the future, Proceedings of CIB W78 conference, Stockholm, Sweden, 1998, p.p.191-207



---

## 4.5 Information Modelling of a Façade

The different CAD systems in the architectural industry bring with them a variety of formats that complicate the electronic data exchange. According to German statistical information from the “Verband der Projektsteuer”, one can economize by up to 2% on building expenses during planning and construction, thanks to the problem-free data exchange.

That would save approximately 10.5 million DM/year in the German architectural industry.<sup>120</sup>

For CAD data-exchange, the following solutions exist:<sup>121</sup>

- *DXF as a present industrial standard*
- *IFC models that were and are being developed by the IAI*
- *The family international norms ISO 10303 (STEP)*

In this work, the information model is described with EXPRESS, comparing it with the IFC2x Edition 2, because the IFC model aims at direct application during the planning phase and provides not only a semantic representation but also a graphical one which can be easily understood visually.

---

### 4.5.1 Real- and Abstract-Worlds in an Information Model

In the context of computer based information handling, a “conceptual model” is called an “information model”.<sup>122</sup> Referring to computer based models, e.g. product models, we normally mean the information model and not a concrete representation in the computer. An information model is used

---

<sup>120</sup> Verband der deutschen Bauindustrie, 1998

<sup>121</sup> See Jeffrey Wix’s article “Industry Foundation Classes Release 2 – An Introduction to the International Alliance Interoperability and the Industry Foundation Classes”, IAI, 1999

<sup>122</sup> D. Schenck and P. Wilson, op.cit., p.p.5-11

to capture the characteristics of a real-world object or process, using a formalised notation. It is used to define interface models for data exchange and data access and to define data models for applications dealing with semantics; the ultimate goal of information models is to formulate descriptions of real-world information so that they may be processed and communicated efficiently without any knowledge of their source and without making any assumptions.<sup>123</sup>

Fig.128 Purpose of information models

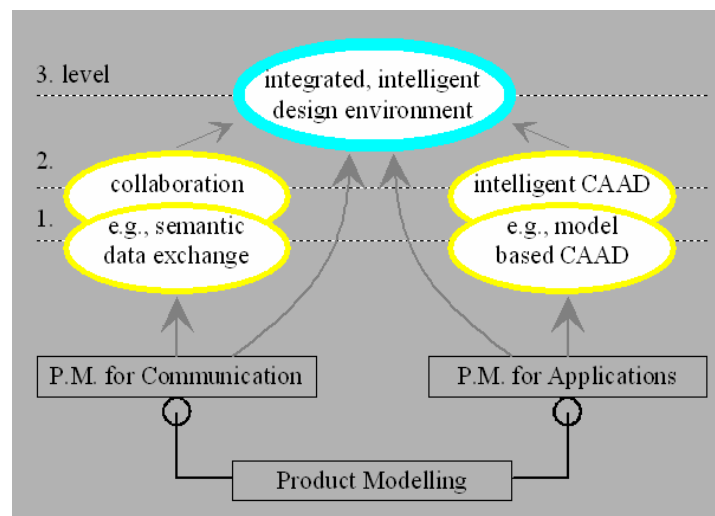

During design support, it is important to transfer the essentials of the applied structures and mechanisms without overloading the other systems with unwanted details. This information control is usually applied by using abstraction.

How can we describe, and then integrate the information of the real-world into the abstract-world? Fig.129 illustrates the concept of this well; the real-world of a telephone number, address and name of a person is described with EXPRESS and EXPRESS-G for representation in the abstract-world.

<sup>123</sup> Ibid., p.6

Fig.129 An abstraction of the real-world  
 (http://www.epmtech.jotne.com)

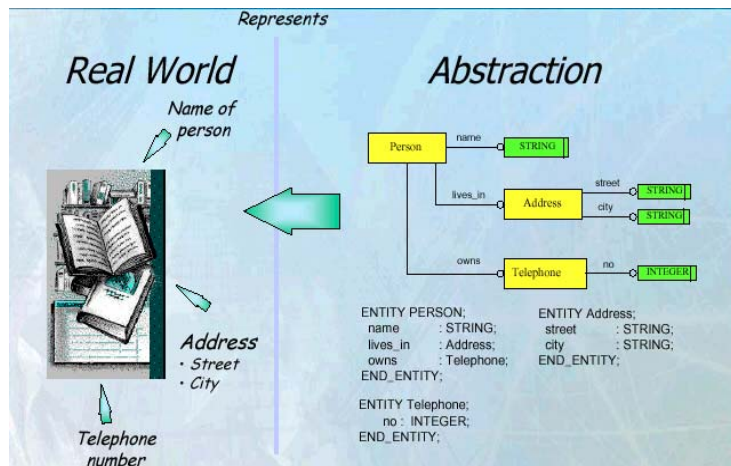

With the increasing use of information models, it also becomes also possible to incorporate multiple abstraction levels into the design representation. In this case, an information model is always an abstraction of the real-world, based on the intended purpose of a model.

Currently, the information model is able to carry out the highest levels of semantic information. This type of model can contain information not only related to geometry, but also regarding material, time schedules, construction methods, cost plans etc., similar to the above-mentioned IFC-model.

This is illustrated in Fig.130, where a door is described with its attributes and its relationship with other objects, compared to the explicit geometric representation of a CAD drawing.<sup>124</sup>

Fig.130 The representation of a door is illustrated on the left as a layered CAD drawing and on the right as an example of an information model

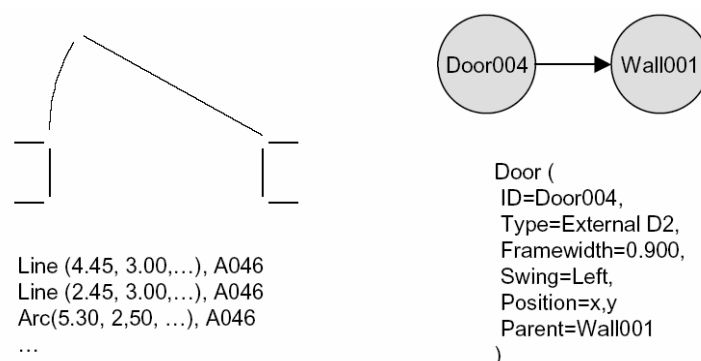

<sup>124</sup> The following example is cited from Robert Noack's thesis "Converting CAD Drawings to Product Models", Royal Institute of Technology, Stockholm, 2001, p.4

---

#### 4.5.2 Information Data Model of a Façade

Data models are concerned with specifying the appearance and structure, within a computer system, of the data which represents particular types of information. Information models have a goal of describing information, as above mentioned, so that the representation data could be computer processed<sup>125</sup>; information models are a computer-interpretable description of an artefact, structured according to a predefined information data model.

Here, the information data-model is restricted to a façade only and does not include other information about the buildings, as the application system that will be presented in Chapter 5 is concerned mostly with the appearance of a design.

A façade is the front of a building usually given special architectural treatment. The hierarchical decomposition of a façade into its parts is as follows: a façade consists of elements, such as structural layers, openings, surfaces and columns which are described as optional attributes.

It is explained how each element of a façade is incorporated into abstraction by means of EXPRESS-G, for representation of important design information. At this point, some entities appear as yet undefined, compared with the IFC2x. Thus, the proposed information model can be referred back to further development of the IFC2x-model.

It should be noted that each measurement that will be presented, such as height, length or width, diameter of a building and its elements, corresponds to the `IfcPositiveLengthMeasure` of the IFC2x-model which is described as `Defined Types` and is one type of `IfcMeasureValue` under the `IfcValue`, as shown in Fig.131; usually, it is measured in millimetres (mm).

---

<sup>125</sup> Ibid., p.10

Fig.131  
IfcPositiveLengthMeasure in the  
IFC2x

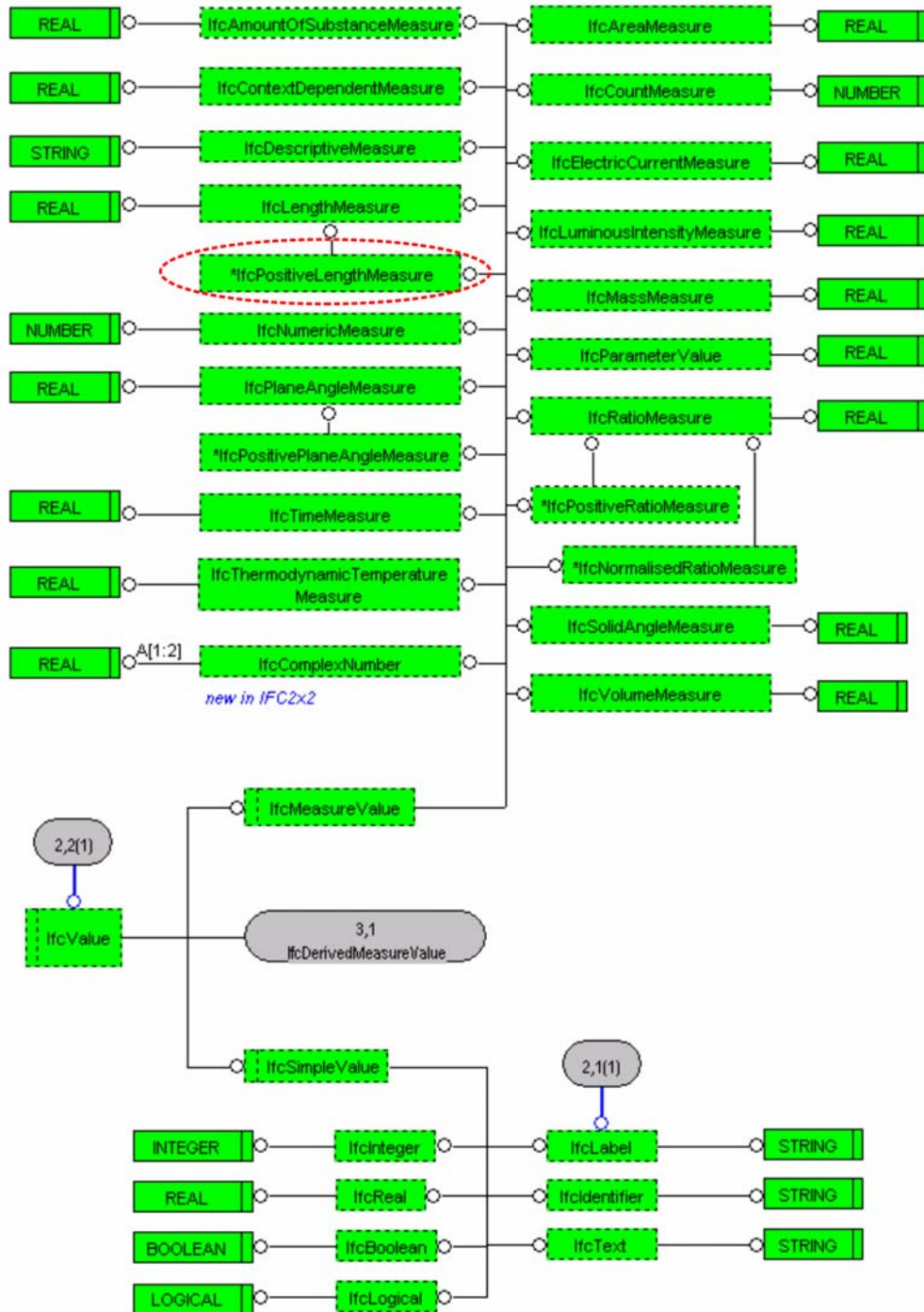

According to the IFC2x, the object placement is given as follows:

- *absolute, i.e. by an axis2 placement, relative to the world coordinate system,*
- *relative, i.e. by an axis2 placement, relative to the object placement of another product,*
- *by grid reference, i.e. by the virtual intersection and reference direction given by two axes of a design grid.*

For example, the local placement for IfcWindow is described in the IfcProduct. It is defined by the IfcLocalPlacement, which defines the local coordinate system that is referenced by all geometric representations. The object position that will be presented corresponds to the above mentioned object placement of the IFC2x. Fig.132 shows the original diagram of the object placement in the IFC2x.

Fig.132 IfcObjectPlacement in the IFC2x

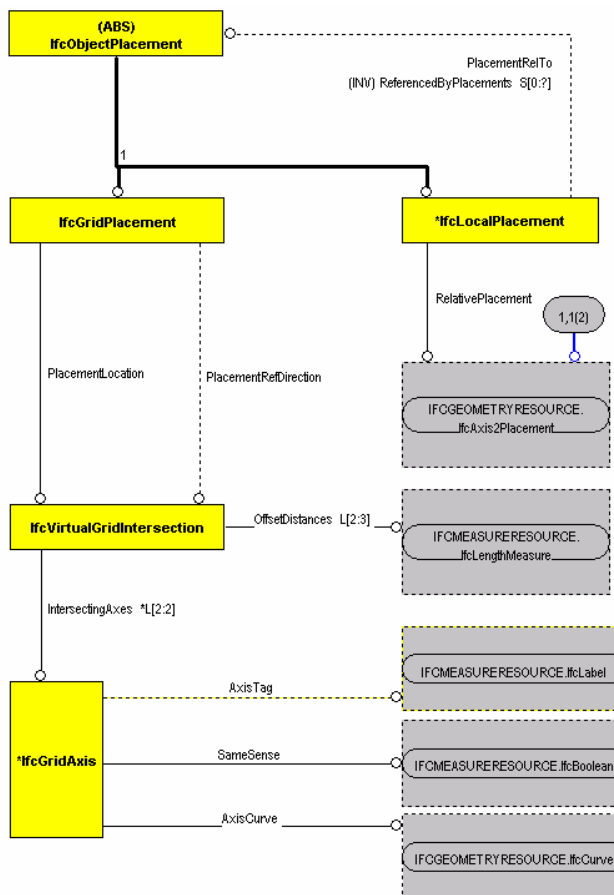

---

#### 4.5.2.1 Structural Layer

As shown in Fig.133, a structural layer may have openings. A surface may have several configurations of elements, such as tiles, stones or pieces of glass and it may have additional attributes such as colour. A structural layer has certain materials and surfaces on each side. Openings such as windows or doors may be attached to structural layers directly. Layer type is used for more accurate definition. Types include layers with a constant thickness, curved layers or layers where the thickness varies according to a mathematical function. The reserved spaces are defined considered as having to be filled with some equipment, usually HVAC equipment. The definition of a structural layer can be compared to the other existing solution, the IFC2x model.

Fig.133 The information structure for a structural layer

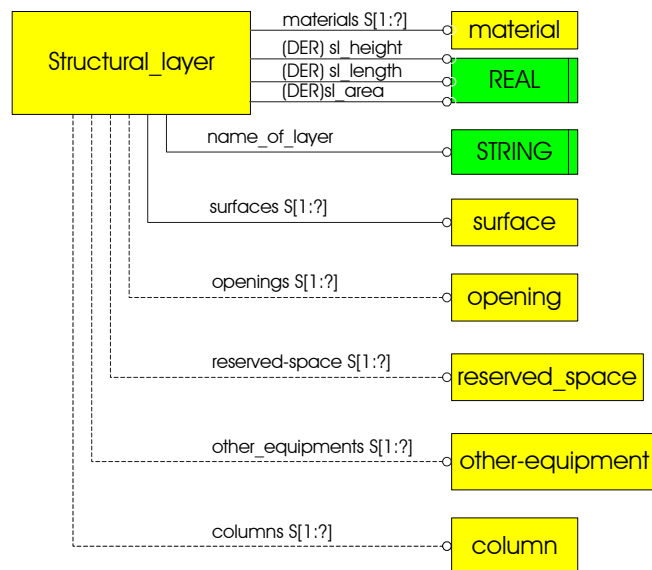

---

#### 4.5.2.2 Opening

The opening is considered as passing through structural layers, as shown in Fig.134. An opening is mostly filled by windows, doors or both. Windows, doors and other equipments such as pipes are defined as optional attributes

for the opening. Thus, an opening can also be empty and thus can be interpreted as a hole.

Fig.134 The information structure for an opening

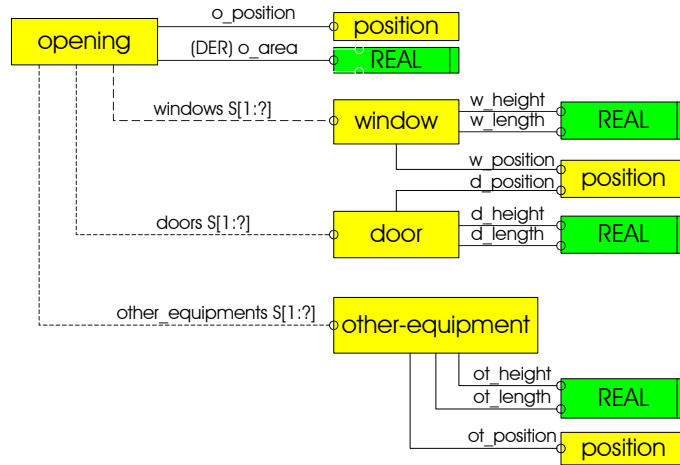

#### 4.5.2.3 Surface

The information structure of a surface is shown in Fig.135. A surface may have many material alternatives. It may also have a surface finish and different surface patterns. If the surface of a façade consisted of, for example, stones, there would be joint-surfaces between the stones, which would have their own positions/placements. Thus, the relationship between materials and element\_joint is described as the optional attributes.

Fig.135 The information structure for a surface

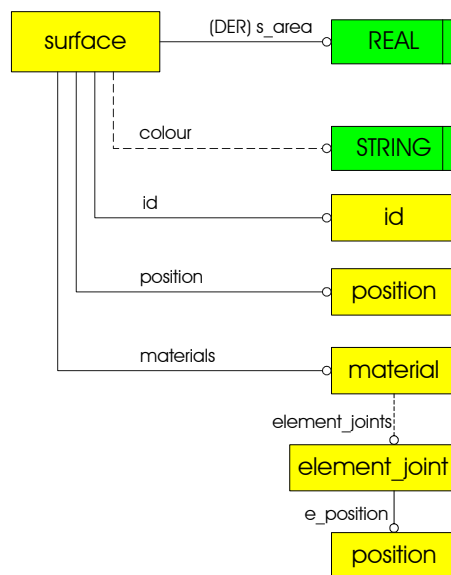



---

#### 4.5.2.4 Column

Fig.136 illustrates the information structure of a column which is an optional attribute of a façade. Mostly, columns are located behind the wall. However, we can find exterior columns which are used as a part of an arcade or as pseudo-columns for decoration or the design goal.

The column is the supertype of the rectangular\_column and the oval\_column. Each square is derived from each subtype.

Fig.136 The information structure for a column

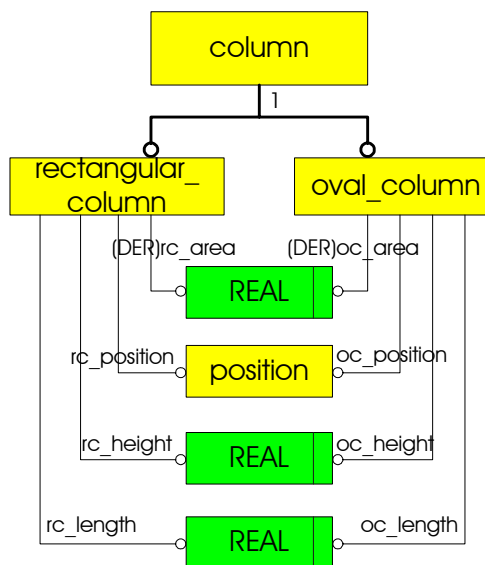

---

#### 4.5.2.5 Overall Model

The subschemata presented above are integrated and illustrated as one schema, as shown in Fig.137. This model contains physical parts of the façade that are related to each other element, which allows input of information about a façade in applications for design-principles. It consists of different levels of abstraction in which the façade is first decomposed into “structural\_layer” that has a functional specification. Then, the structural\_layer are decomposed into surface, other\_equipment, reserved\_space, opening, column and material.

For ease of legibility, some attribute-definitions are omitted from this picture.

Fig.137 The overall EXPRESS-G diagram of the façade

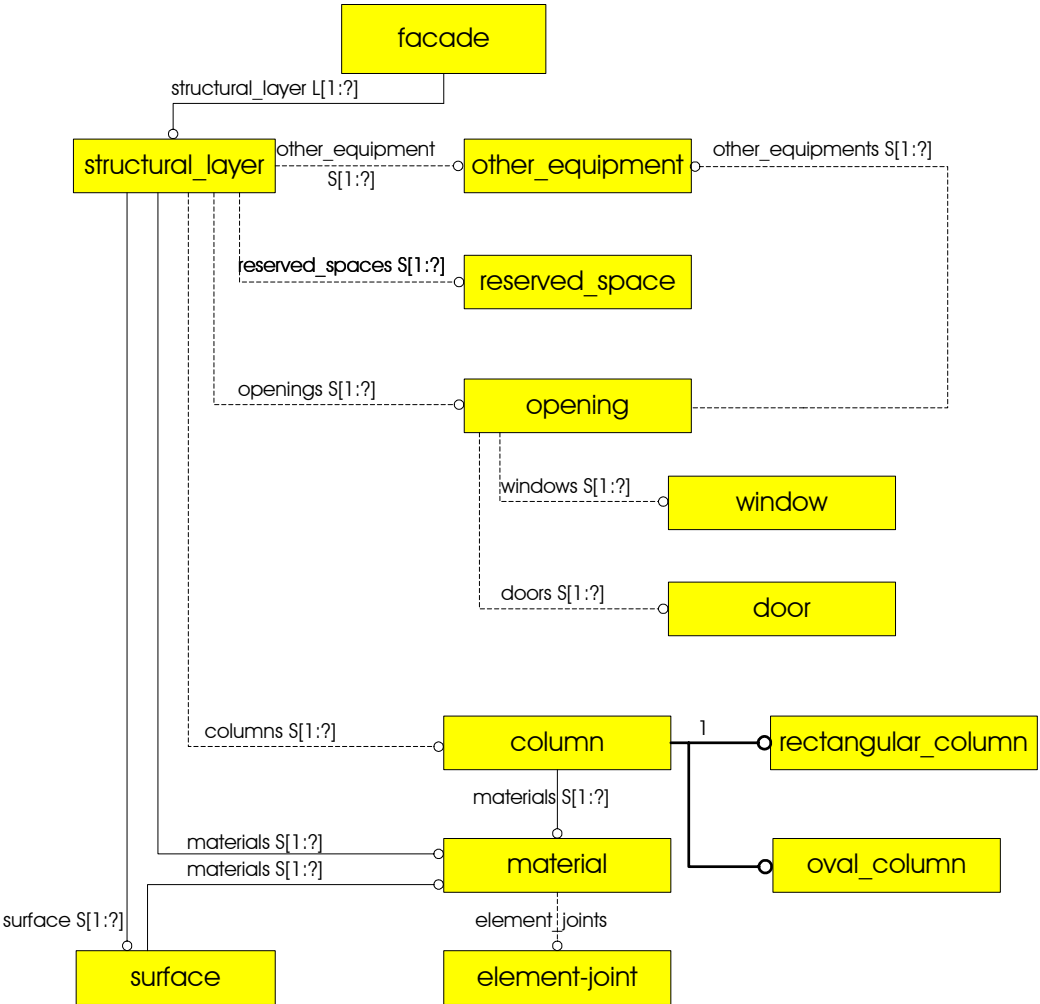

## 5. CHAPTER

# Application Design Modelling of Architectural Principles in the AutoCAD Environment

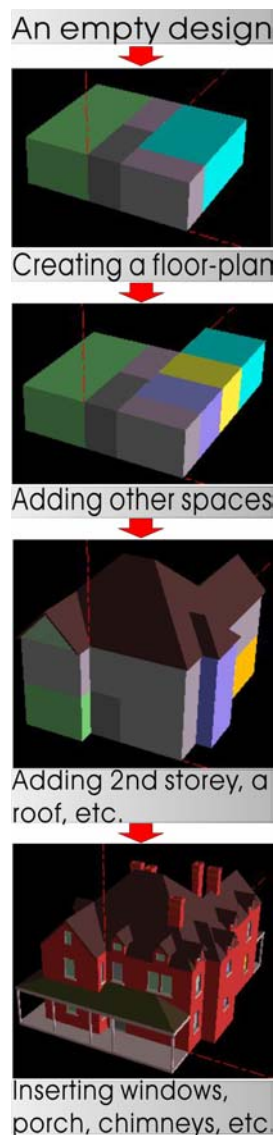

Fig.138 Derivation path of Queen Anne house by Ulrich Flemming

At present, most architects use computer-aided tools in various aspects of their professions, from drafting to data processing operations, but computer-aided design systems are aimed at serving as drawing tools which are used only after a design solution has already been established by the architect. Thus, there are few computer-aided tools to help the designer in selecting the best suited design strategies at the very early pre-conceptual stage.

On the other hand, there has been a little research which supports the designer in the early design phase of a digital environment, in step with CAAD development since the 1960s. Early research on this led to the idea of generative design systems. Researchers, such as William J. Mitchell and Charles Eastman, considered the CAAD as a problem-solving tool based on the information processing theory. Ulrich Flemming's work in SEED project is also an example of a problem-solving system, which supports the early design phase.<sup>126</sup> Georgy Stiny's shape grammars that generate and analyze new designs were a similar computational approach. He developed the basic concept for shape operations and relationships, including sub shapes and their algorithms.

For example, Ulrich Flemming developed a Prolog

<sup>126</sup> See Burak Pak, Ozan Önder Özener and Arzu Erdem's article "Xp-GEN : A randomized design tool for non-deterministic digital design methods in architecture and visual design" in the website <http://virtuvius.itu.edu.tr> (2003)

programme that implemented his grammar for Queen Anne house, as shown in Fig.138.

As in the above-mentioned cases, when a new CAAD environment starts to assist designers from the early design-phase, the best opportunities for improving the design-methodology and –quality can arise. The proposed application system is studied as part of the new CAAD environment. This system is aimed at the increasing use of computer-based design tools for testing design information, i.e. optimum design quality, including the evaluating of design aspects based on the specific design principles, for effective integration in the architectural design process.

---

## 5.1 Design Process and the Application Model

Design is decision making. The key to successful projects lies not only in the final form but also in the design process leading up to it. Poor design decisions can be costly to correct or have lasting social implications.<sup>127</sup> Therefore, the design process must be as carefully considered as the design of forms. The design process is comprised of various phases from vagueness to precision. This is a process of continuous refinement, starting from the first conceptual ideas, where only vague representations of the designed objects are possible to be made, to more and more precise definitions of the design.<sup>128</sup>

According to The Royal Institute of British Architects (RIBA 1995), the standard building design-process is proposed as follows:

---

<sup>127</sup> Ellen Shoshkes, *The Design Process – Case Studies in Project Development*, Architecture Design and Technology Press, London, 1990, p.8

<sup>128</sup> R.Junge, R.Steinmann and K.Beetz, *op.cit.*, p.628

- *Outline Design Stage*
- *Scheme Design Stage*
- *Detailed Design Stage*

In the outline-design stage, a concept based on feasibility studies is prepared. It is represented by a conceptual design which consists of the sketches and the preliminary design phases; these are rough and vague, enabling the architect to determine concepts and basic ideas of the construction: the concept also includes diagrammatical analysis of the requirements for the site, solutions to functional and environmental problems and relationships of spaces and massing.

The scheme-design stage is developed as a more detailed level than the outline-design one. This phase should capture the spirit of the design direction, including preliminary floor-plans, exterior elevations and mass-studies, material concept and simple building sections. Also, preliminary pricing estimates are taken by a contractor during this stage.

Lastly, the detailed-design stage represents refinement of design intent. Detailed design drawings are produced for co-ordinating structure, services and specialist installations. Internal spaces may be annotated with details to include fittings, equipment and finishes.

In these design-stages, it must be noted that architectural design is an iterative process; it consists of a continuous back- and forth-process as the designer selects from a universe of available components and selects from options to synthesize the solution within given constraints.

The proposed application system is used in each design phase to test and advise on optimum design quality according to the analytical, traditional design principles. As mentioned in Chapter 1, it is assumed that the creative design, such as a conceptual sketch, which depends on a human's own spiritual capability, lies with the designer himself.

Hence, this application system has little relationship to the outline-design phase that is concerned with a human's own creativity field. However, a lot of relationships are involved in the scheme-design and the detailed-design phase. This system will solve several major problems, for example, during studies of alternative design for floor-plans, elevations and three-dimensions in the scheme-design phase.

The following diagram shows the design process and the uses of the application system:

Table 17 Design process and use of the application system

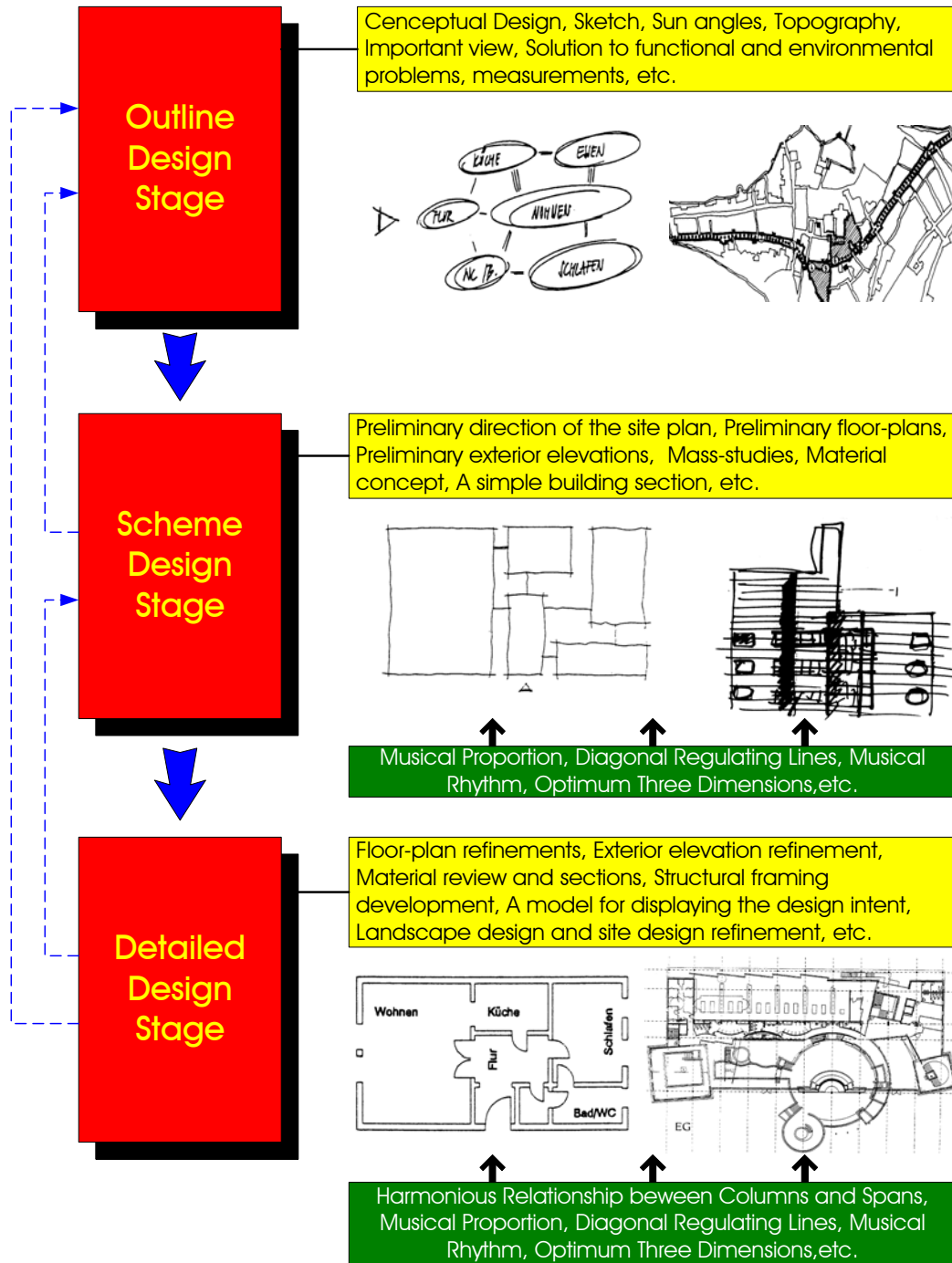

---

## 5.2 Basic Mechanism and Structure of the Programme

---

### 5.2.1 Basic Mechanism of the Programme

The programming language employed in AutoCAD is AutoLISP<sup>129</sup>. It was the first programming language supported by AutoCAD. As this language retains most of the general LISP (LIST Processing Language)<sup>130</sup> -functions, it is a symbolic manipulation-based, interpreted language that provides a simple mechanism for adding commands to AutoCAD.<sup>131</sup> For example, this interactive programming language in AutoCAD allows users to program external applications, using the AutoCAD drawing generation and manipulation functions for 2D geometry, 3D wire-frame structures and 3D curved surfaces. Therefore, customizing AutoCAD into a more useful tool for a particular application for users can be carried out using AutoLISP programmes.<sup>132</sup>

The AutoLISP programme is normally written by “text editors” and then is saved as “text only” with the “.lsp” extension; i.e. van.lsp. An example is shown in the following Table 18, which is concerned with the theory of the Plastic Number of Van der Laan, which was mentioned in Chapter 3:

Table 18 Example of AutoLISP programme

```
(defun c:van()
  (setq txt1(getstring "\nMax. unit, Min. unit or wall thickness
```

---

<sup>129</sup> Along with this, other available programming interfaces in AutoCAD are ActiveX Automation, VBA (Visual BASIC for Applications) and ObjectARX which lets users use the Microsoft C++ programming language to customize AutoCAD.

<sup>130</sup> LISP was developed by John McCarthy at Massachusetts Institute of Technology in the 1950s. The reason why LISP became integrated into AutoCAD is that this language is suited to storage and manipulation of lists.

<sup>131</sup> Werner Sommer, AutoCAD 2000 – Kompendium, Markt&Technik Verlag, München, 1999, p.p.1030-1034

<sup>132</sup> Visual LISP comes with AutoCAD 2000 and has enhanced AutoLISP’s command vocabulary with a host of functions, such as an IDE (Integrated development environment) with a compiler, debugger, and other development tools.



```

                                as the ground one?(Ma/Mi/W:"))
(if (= (strcase txt1) "MI")
  (progn
    (setq le1(getreal "\nEnter the min. unit:"))
    (setq sw2 le1)
    (setq xe1 (/ sw2 50))
    (setq xw2 (* 7 xe1))
    (setq se1 xw2)
    (setq lw2 (+ (* 7 le1) se1 xe1))
    (dtr1)
  ) ;progn
) ; if

(if (= (strcase txt1) "MA")
  (progn
    (setq lw2(getreal "\nEnter the max. unit:"))
    (setq xe1 (/ lw2 358))
    (setq xw2 (* 7 xe1))
    (setq se1 xw2)
    (setq sw2 (* 50 xe1))
    (setq le1 sw2)
    (dtr1)
  ) ;progn
) ; if

(if (= (strcase txt1) "W")
  (progn
    (setq xe1(getreal "\nEnter the wall thickness as the smallest
                                unit:"))
    (setq xw2 (* 7 xe1))
    (setq se1 xw2)
    (setq sw2 (* 50 xe1))
    (setq le1 sw2)
    (setq lw2 (+ (* 7 le1) se1 xe1))
    (dtr1)
  ) ;progn
) ; if

```

```

) ; if

(setq m1 lw2)
(setq m2 (+ lw1 sw1 spa2 spa1))
(setq m3 (+ lpa2 lpa1))
(setq m4 (+ (* lpa1 2) sp2 sp1 se2 se1 xw1))
(setq m5 (+ (* lp2 3) se2))
(setq m6 (+ (* lp1 4) se1))
(setq m7 (+ (* le2 5) spa1 xw1))
(setq m8 (+ (* le1 7) d2e2))
)

```

For implementation, users must load AutoLISP-files into a computer's memory before using them. There are various ways of loading them. For instance, they can be loaded by typing the instructions in the command prompt in AutoCAD, as follows:

```

COMMAND: (load "d:/LISP/van")
D:VAN

```

The choice of AutoLISP in this work has been made for several reasons: this author's amount of experience with both AutoLISP and AutoCAD; the reliable graphic control/output in AutoCAD and the worldwide usage of this system in architectural offices.

In the developed programmes, the essential design rules which examine the planning for better design, namely the Diagonal Regulating Lines' Rule, Harmonious Proportion's Rule, Musical Proportion's and Rhythm's Rule, etc., were entered.

These programmes can be used as soon as they are needed and simultaneously the user can obtain some design advice from his own computer for a quality assessment of the particular design qualities.

---

## 5.2.2 Structure of the Programme

From a technological viewpoint, the method proposed relies on the basic CAD system allowing us to customize standard programmes to a wider extent, and is based on a module structure principle of programme development. The whole system includes various programmes for developing design quality by using analytical design principles in architecture.

This system consists of the following sub sections:

- *The subsystem of three dimensional heights for harmonious relationship between building groups.*
- *The subsystem of musical proportion, for elevation and floor-plan.*
- *The subsystem of diagonal regulating lines, for checking the design quality of an elevation or floor-plan.*
- *The subsystem of harmonious proportion based on the traditional theory.*
- *The subsystem of musical rhythm between windows, for elevation.*
- *The subsystem of harmonious relationship between columns and spacing, according to Van der Laan's Plastic Number.*

The system demonstrated here operates in MS-Windows XP and in the AutoCAD 2000 environment.

---

## 5.3 Schema and Process of Information Model

---

### 5.3.1 Conceptual Schema in Information Model

In the following pages, the conceptual schema of a façade for the implementation, which plays a basic role in information models, is presented.

The conceptual schema describes the process of the information about an architectural façade, which is needed for applying design principles to information models. A schematic view is shown in Fig.139.

Fig.139 Conceptual schema of a façade

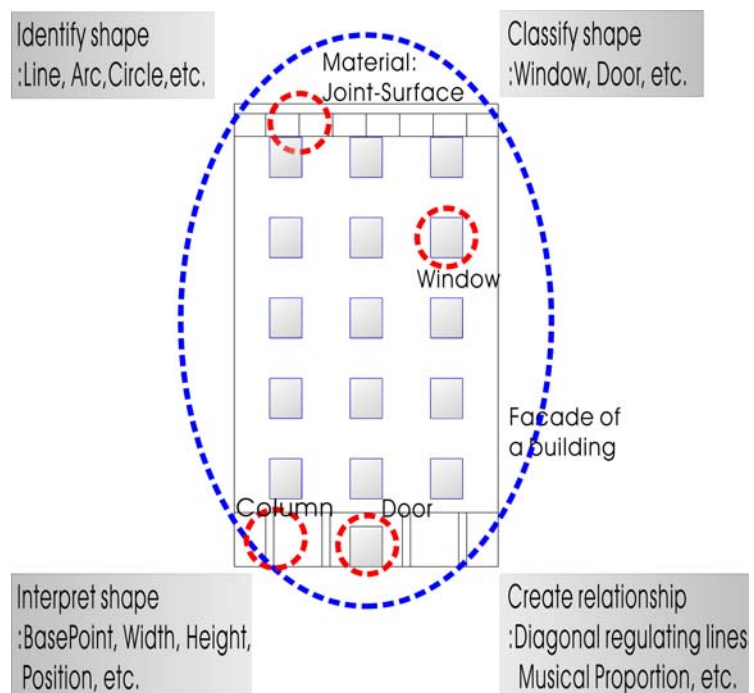

Four major sources of the information about this façade are described in this schema. These consist of:

- *Identifying shape: line, arch, circle, etc.*
- *Classifying shape: window, door, column, façade, material of surface, etc.*

- *Interpreting shape: base-point, position, width, height, etc.*
- *Creating relationship: diagonal regulating lines, musical rhythm between windows, harmonious proportion, optimum spacing-distance between columns*

For implementation in an information model, each shape has to be defined and found in a drawing first. In general, a shape consists of a set of lines and curves which are usually connected. When each of the elements of a shape has been identified, it then has to be classified, in order to be recognizable by a computer by its own name, such as a window, a door, column, etc.

The interpretation of a shape is considered as the process that shifts the semantic content of the drawing to a higher level. Normally, this phase is one of main goals of IFC2x, and is the key to implementation of the application system in an object-orientated CAD-system; here, different aspects of an object are analyzed and stored as parametric values.

When all elements of a façade have been recognized, their relationships can be analyzed and proposed by implementation of the AutoLISP. Thus, the design is “qualified”, according to the optimum design principles.

---

### **5.3.2 Process for the development of Information Model**

A process model provides a description of tasks needing to be undertaken. It defines all of the required tasks within the process and puts them in a logical sequence.<sup>133</sup>

The following process diagram illustrates the required scope of specification development for applying the architectural design-principles to CAAD systems in the framework of an

---

<sup>133</sup> J.Wix and T.Lieblich, Industry Foundation Classes – Architecture and Development Guidance, IAI, 1999, p.426

information model.

The process diagram of the information model is illustrated in the following table:

Table 19 Process diagram of the information model

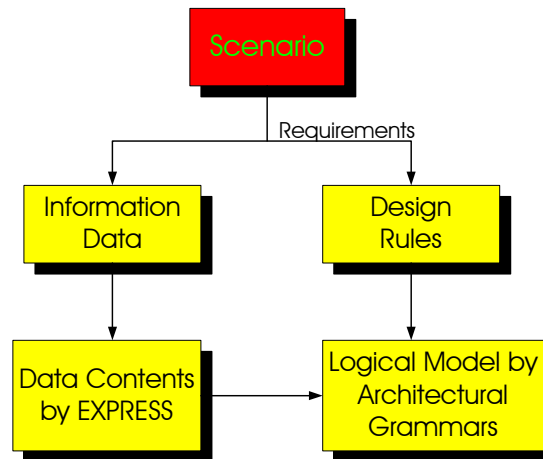

The information data and data contents using EXPRESS are already described in Chapter 4, which give the fundamental information about a façade. In these phases, general entities, attributes and relationships between a building and its elements are defined.

The design rules and logical model using architectural grammars are described in the following pages.

## 5.4 Sub-Systems for Aesthetic Measurement

### 5.4.1 Subsystem of Musical Rhythm between Windows

The relationship between windows is based on the symmetrical time-rhythms which have been used in architecture.<sup>134</sup> A rhythm of windows can become one of the different symmetrical time rhythms, such as 2, 3, 4, 5, 6 or 7, or their combinations. The designer can choose his preferred rhythm from those shown on the screen. The process of the subsystem of musical rhythm between windows is illustrated as follows:

#### Shape

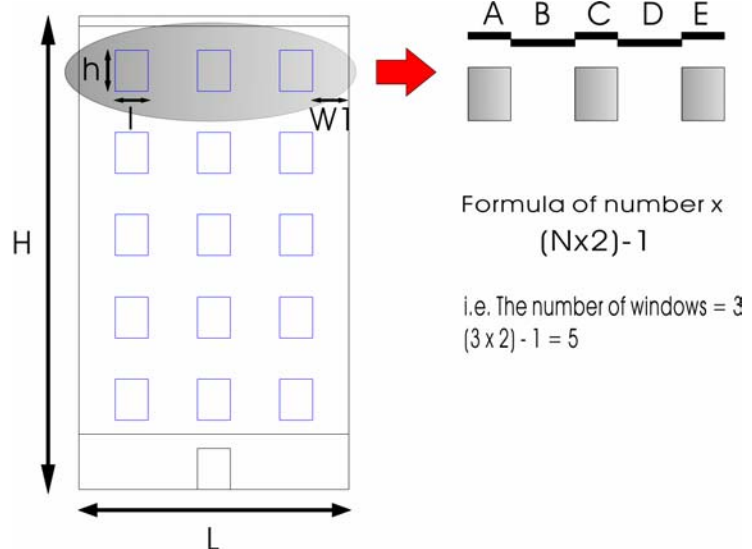

#### Rule

A : B : C : D : E =	1 : 2 : 3 : 2 : 1
	2 : 1 : 3 : 1 : 2
	3 : 1 : 2 : 1 : 3
	3 : 2 : 1 : 2 : 3

<sup>134</sup> More detailed information about the time-rhythm is given in Section 3.1.3.1

## Requisite Entities for the Information Model

- *TotalHeight of the Building: IfcQuantityLength*
- *TotalWidth of the Building: it can be measured from IfcQuantityArea*
- *OverallHeight of a Window: IfcPositiveLengthMeasure in the IfcWindow*
- *OverallWidth of a Window: IfcPositiveLengthMeasure in the IfcWindow*
- *Placement : IfcObjectPlacement (referenced entity : IfcLocalPlacement)*
- *Distance between Windows: it can be derived from the position of each juxtaposed window.*

---

### 5.4.2 Subsystem of Musical Proportion

Music is made up of sounds. Sound consists of repeating sound-waves. The musical pitch of each note has a corresponding frequency measured physically in Hz (hertz) or cycles per second. There are some important mathematical relationships between the notes played in music and the frequency of those notes. For example, A note, which is nine keys below middle C, has a frequency of 440 Hz. The frequency of A# is  $440 \times 1.059\dots = 466.16376\dots$  and that of B is  $466.1637 \times 1.0594 = 493.8833$ , as the second constant value in music is the 12<sup>th</sup> root of 2:  $1.0594630943593\dots$ . After we do this 12 times, we end up with A an octave higher, which equals 880 Hz. From the C note to the C1 note, the frequency of each note is illustrated in the following Fig.140:

Fig.140 Musical tone and corresponding Hz.

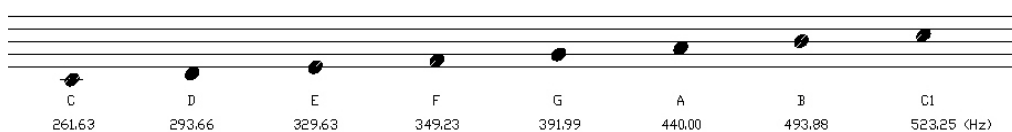



The first person to make the connection between mathematics and music was Pythagoras, as mentioned in Chapter 3. His theory was that pleasing sounds resulted from frequencies with simple ratios. What we now call octaves, perfect fifths, and major thirds have ratios of 2 to 1, 3 to 2, and 5 to 4 respectively. For example, if A note is tuned to a frequency of 440 hertz, then a perfect fifth above that note has a frequency of 660 hertz, because the ratio of 660 hertz to 440 hertz is 3 to 2. (In symbols,  $660 \text{ Hz} : 440 \text{ Hz} :: 3 : 2$ .) In this way, musical structure can be demonstrated in the octave starting with C<sup>135</sup>, using Pythagoras' ratios by which most of the notes are tuned to a scale:

Fig.141 Musical structure and ratios

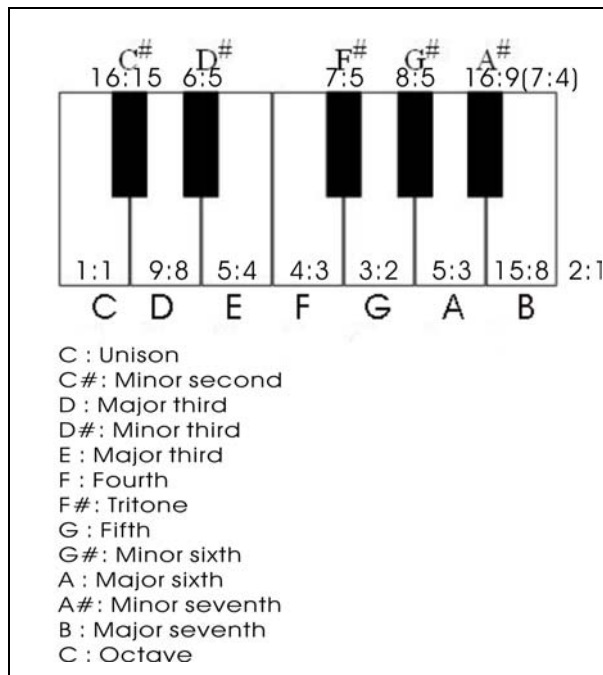

The subsystem for musical proportion is illustrated as follows:

<sup>135</sup> The standard scale, based on C, is the sequence of ascending notes C D E F G A B. These notations are connected to the previous system in the following way: C=Do, D=Re, E=Mi, F=Fa, G=Sol, A=La, B (German H)=Si or Ti.

**Shape**

Case I

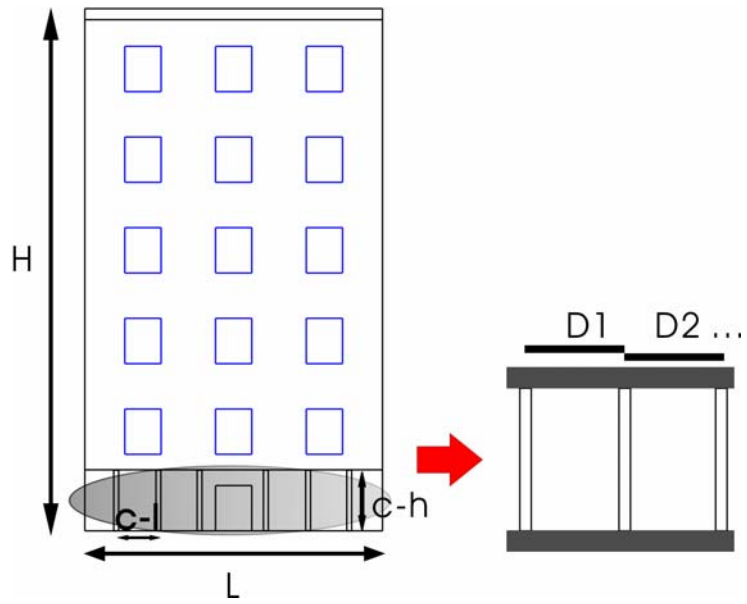

Case II

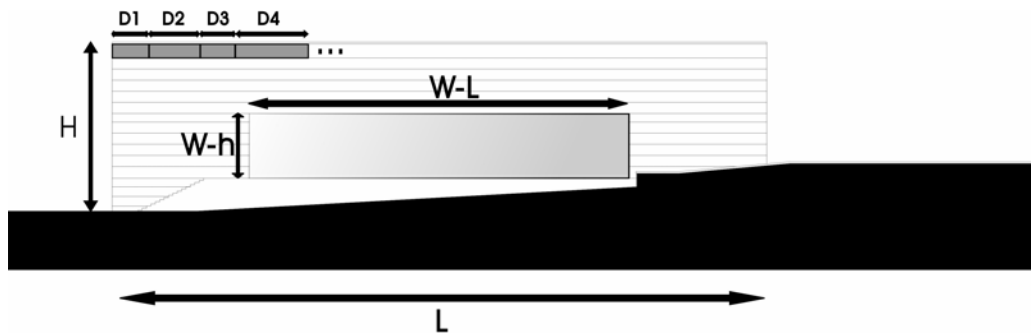

**Rule**

$D1 : D2 : D3 : D4 \dots$  = according to musical ratio or melody:  
 i.e. ratio series such as  $1/1, 15/16, 8/9, 5/6, 4/5, 3/4, 5/7, 2/3, 5/8, 3/5, 4/7$   
 ( $9/16$ ),  $8/15$  and  $1/2$   
 or melodies

Andante. Comthur.  
 Deine La-dung  
 Don-ner-son-ni

2  
 2  
 0.5  
 1.5  
 2

## Requisite Entities for the Information Model

- *TotalHeight of the Building: IfcQuantityLength*
- *TotalWidth of the Building: it can be measured from  
IfcQuantityArea*
- *OverallHeight of a Column: IfcRectangleProfileDef.XDim*
- *OverallWidth of a Column: IfcRectangleProfileDef.YDim  
(in the case of a round column: IfcCircleProfileDef.Radius)*
- *Joint\_surface between Materials: distance between joint-surfaces can be derived from IfcMaterial*
- *Placement : IfcObjectPlacement  
(referenced entity : IfcLocalPlacement)*
- *Distance between Columns: it can be derived from the position of each juxtaposed column.*

---

### 5.4.3 Subsystem of Harmonious Relationship between Columns and Spacing

Van der Laan analyzed the relationship between columns and spacing in the ancient temples which Vitruvius had specified in his book “The Ten Books”. Van der Laan transformed the analytical ratios of the temples into simple integer ratios within the framework of his theory “The Plastic Number”; the result is shown in Table 7 of Chapter 3.

In this subsystem, these ratios of five proportions are translated into the ranges of thickness and spacing of columns.

The process of this subsystem is illustrated as follows:

### Shape

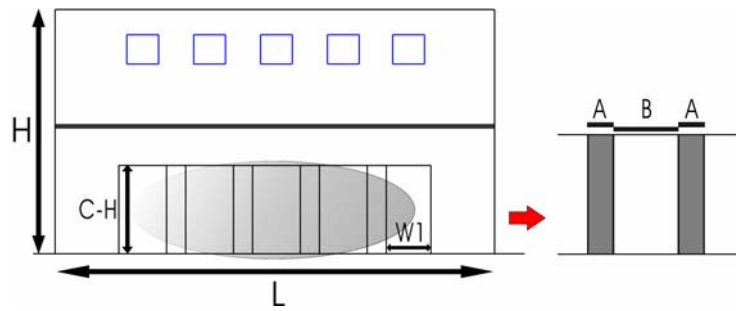

### Rule

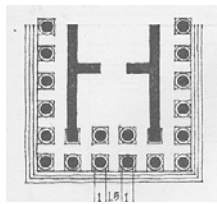
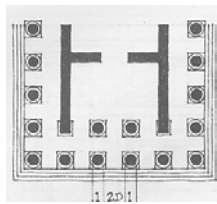
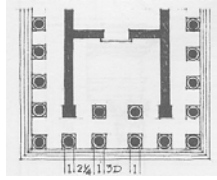
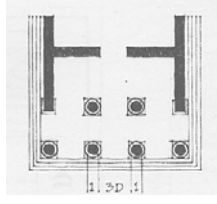
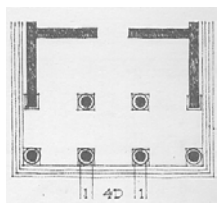
A : B =	Pycnostyle		2:3
	Systyle		1:2
	Eustyle		4:9
	Diastyle		1:3
	Araeostyle		1:4

## Requisite Entities for the Information Model

- *TotalHeight of the Building: lfcQuantityLength*
- *TotalWidth of the Building: it can be measured from lfcQuantityArea*
- *OverallHeight of a Column: lfcRectangleProfileDef.XDim*
- *OverallWidth of a Column: lfcRectangleProfileDef.YDim*  
(in the case of a round column: *lfcCircleProfileDef.Radius*)
- *Placement : lfcObjectPlacement*  
(referenced entity : *lfcLocalPlacement*)
- *Distance between Columns: it can be derived from the position of each juxtaposed column.*

### 5.4.4 Subsystem of Harmonious Proportion

The proportion of a rectangle indicates the relationship between its width, height and length, as shown in Fig.142:

Fig.142 Proportion of a rectangle

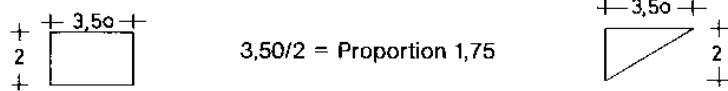

This proportional relationship can be the outline format, if the building has a rectangular form. According to the proportion theory proposed by Professor Fiederling<sup>136</sup>, all other proportions of buildings are the derivations of this basic proportion. Hence, the following derivations are the results of measurement of aesthetic buildings.

*If p is a basic proportion, the derivations result as follows:*

*p and 1/p,  $\sqrt{p}$  and  $1/\sqrt{p}$ ,  $p^2$  and  $1/p^2$ ,  $p^3$  and  $1/p^3$  etc.*

*If the proportion is 1.75, the derivations result as follows:*

*1.75 and 1.14, 1.32 and 1.51, 1.53 and 1.31, 1.34 and 1.49*

<sup>136</sup> Otto Fiederling, Theorie des Entwerfens – Das Entstehen des Architekturentwurfs, Curt R. Vincentz Verlage, Hannover, 1975

A series of numbers of **p** have a certain harmonious ratio, so that these numbers represent a harmony such as the Golden Section or Fibonacci Number.

**Shape**

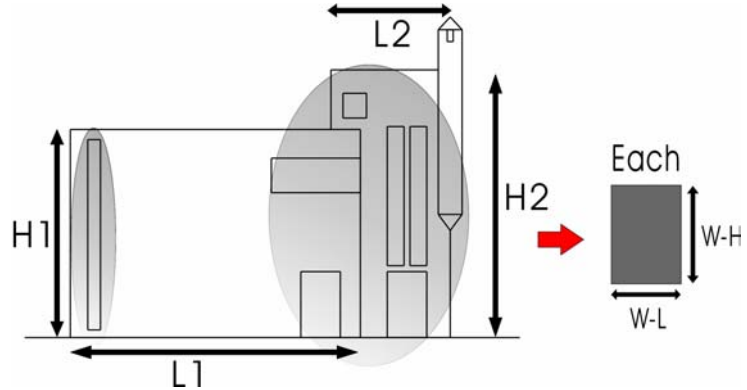

**Rule**

Prim.		Root		Sqr.		Tert.		Quart.	
p	1/p	$\sqrt{p}$	$1/\sqrt{p}$	$p^2$	$1/p^2$	$p^3$	$1/p^3$	$p^4$	$1/p^4$
1.05	1.90	1.03	1.95	1.10	1.18	1.15	1.74	1.21	1.65
1.10	1.82	1.05	1.90	1.21	1.64	1.33	1.50	1.46	1.37
1.15	1.74	1.07	1.86	1.32	1.51	1.52	1.32	1.75	1.14
1.20	1.66	1.10	1.82	1.44	1.38	1.73	1.16	1.03	1.94
1.25	1.60	1.12	1.78	1.56	1.28	1.95	1.02	1.22	1.64
1.30	1.54	1.14	1.76	1.69	1.18	1.10	1.82	1.43	1.40
...	...	...	...	...	...	...	...	...	...

**Requisite Entities for the Information Model**

- *TotalHeight of the Building: IfcQuantityLength*
- *TotalWidth of the Building: it can be measured from IfcQuantityArea*
- *OverallHeight of a Window: IfcPositiveLengthMeasure in the IfcWindow*

- *OverallWidth of a Window: IfcPositiveLengthMeasure*  
*in the IfcWindow*
- *Placement : IfcObjectPlacement*  
*(referenced entity : IfcLocalPlacement)*

---

#### 5.4.5 Subsystem of Mass Modelling for Optimization of Three Dimensions

Traditionally, mass modelling is a common method used by architects when designing large buildings, in which their initial design studies are often first modelled in clay or wood. These small models show the relationship between parts of the building, indicate scale, and reveal how light and shadow react with the building façades and so on. Mass modelling is meant to be a quick process, akin to using the building blocks we all played with as children. With this subsystem, users can easily model their concept and this gives them some useful advice, calculating automatically a harmonious proportion-relationship between the blocks. Here, Palladio's theory is applied to the programme to create such a relationship. He restricted the means to the heights of rooms. For flat ceilings, the height is taken to be equal to the width,  $h=w$ . For vaulted ceilings in square rooms, his rule is simply  $h=(4/3)w=(4/3)l$ . For vaulted ceilings in rectangular rooms, the height is determined in three possible ways, corresponding either to the arithmetic, geometric or harmonic mean: using the arithmetic mean  $h=(w+l)/2$ ; using the geometric mean  $h=\sqrt{wl}$ ; using the harmonic mean,  $h=2wl/(w+l)$ :

## Shape

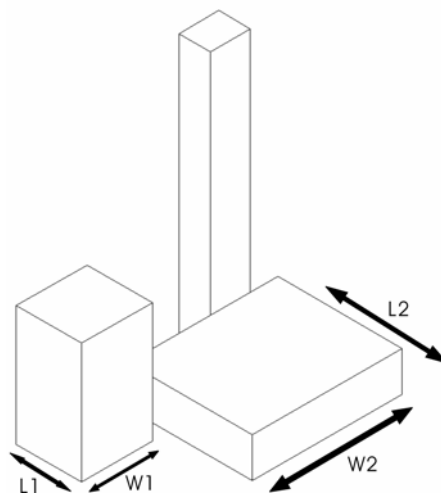

## Rule

Type of room	Formula
Flat ceiling	$h = w$
Vaulted ceiling in square room	$h = (4/3)w = (4/3)l$
Vaulted ceiling in rectangular room	$h = (w+l)/2$
	$h = \sqrt{wl}$
	$h = 2wl/(w+l)$

## Requisite Entities for the Information Model

- *TotalWidth of a Building: it can be measured from*  
*IfcQuantityArea*
- *OverallLength of a Room: it can be measured from*  
*IfcQuantityArea* under *IfcBuildingStorey* or  
*IfcSpatialStructure*
- *OverallWidth of a Room: it can be measured from*  
*IfcQuantityArea* under *IfcBuildingStorey* or  
*IfcSpatialStructure*
- *Placement : IfcObjectPlacement*  
*(referenced entity : IfcLocalPlacement)*



---

#### 5.4.6 Subsystem of Diagonal Regulating Lines

The concept of proportion based on similar figures, revealed by diagonal regulating lines, was invented by August Thiersch (1843-1916). The theory of the diagonal regulating lines is described well in his following argument<sup>137</sup>:

*Wir finden durch Betrachtung der gelungensten Werke aller Zeiten, dass in jedem Bauwerk eine Grundform sich wiederholt, dass die einzelnen Teile in Form und Anordnung ähnliche Figuren bilden. Es gibt unendlich viele verschieden Figuren oder Grundformen, die an und für sich weder schön, noch hässlich genannt werden können. Das Harmonische entsteht erst durch Wiederholung der Hauptfigur des Werkes in seinen Unterabteilungen.*

*(We have found, in observing the most successful products of art of all periods, that in each of them a fundamental shape is repeated, and that the parts form, by their composition and disposition, similar figures. There is an infinite number of shapes and fundamental forms, which, of and by themselves, can neither be called beautiful nor ugly. The harmony is achieved only by repetition of the fundamental form of the product in its subdivisions. )*



Fig.143 View of St. Ursula

This was analysed and applied to a lot of architectural designs, such as the church “St. Ursula” (1894-1897) in Munich, Erechtheion in Athens and Santa Maria Novella in Florence. The similar relationship that produces unity in each floor-plan and each façade is achieved by the repetition of a basic shape; in these, a dominant rectangle, often the whole façade and the floor-plan, was indicated by one of its diagonals, and those parts which were of similar shape were shown in the same way, using the diagonal regulating lines.

---

<sup>137</sup> August Thiersch, Proportionen in der Architektur in „Handbuch der Architekten – Entwerfen, Anlage und Einrichtung der Gebäude“, J.M.Gebhardt’s Verlag, Leipzig, 1926, p.65

Fig.144 The diagonal regulating lines of the floor-plan in St. Ursula

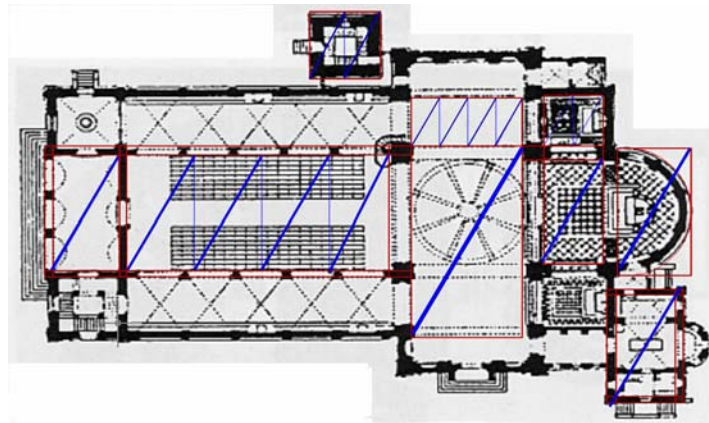

The following diagram illustrates the process of the diagonal regulating lines in the application system and the information model.

**Shape**

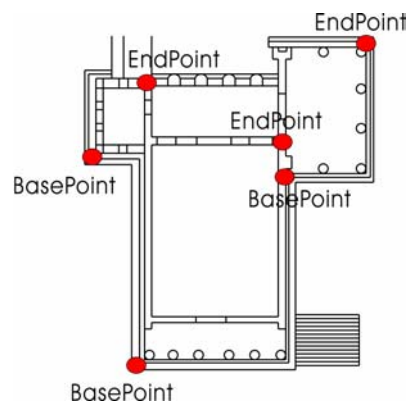

**Rule**

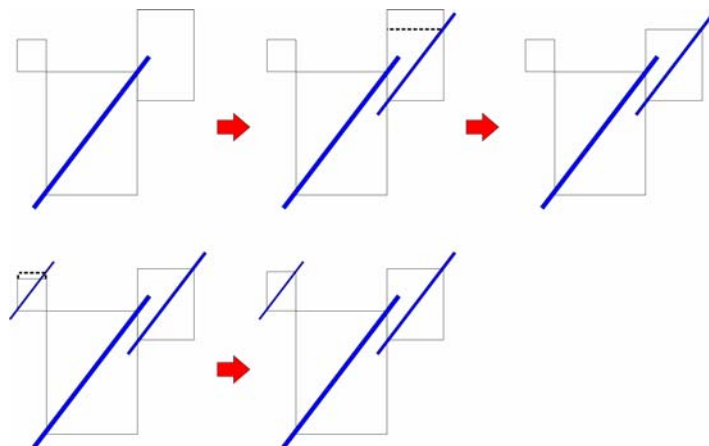

## Requisite Entities for the Information Model

- *OverallLength of a Room*: it can be measured from *IfcQuantityArea* under *IfcBuildingStorey* or *IfcSpatialStructure*
- *OverallWidth of a Room*: it can be measured from *IfcQuantityArea* under *IfcBuildingStorey* or *IfcSpatialStructure*
- *Placement* : *IfcObjectPlacement*  
(referenced entity : *IfcLocalPlacement*)

---

## 5.5 Testing the Developed Methods

---

### 5.5.1 Diagonal Regulating Lines

In Fig.145, the figure shows the recommended proportion for the combination of different building-groups illustrated in Kayser's book. All of the blocks were tested using Thiersch's theory that was programmed with AutoLISP, in order to determine the optimum relationship between proportions and the regulating lines.

Fig.145 Proportion recommended by Kayser

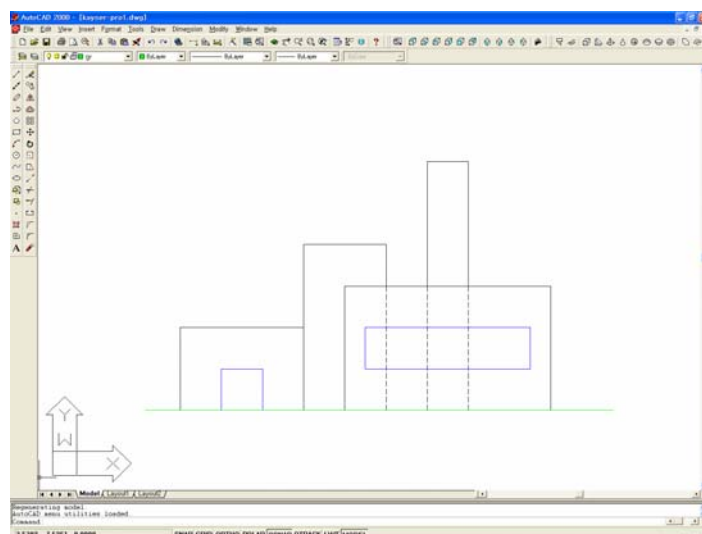

The result is, as shown in Fig.146, that most blocks are almost equal with respect to the rule of the diagonal regulating lines, apart from the fact that only the length of the bottom right green block is shortened.

Fig.146 Harmony through repetition of the fundamental diagonal lines

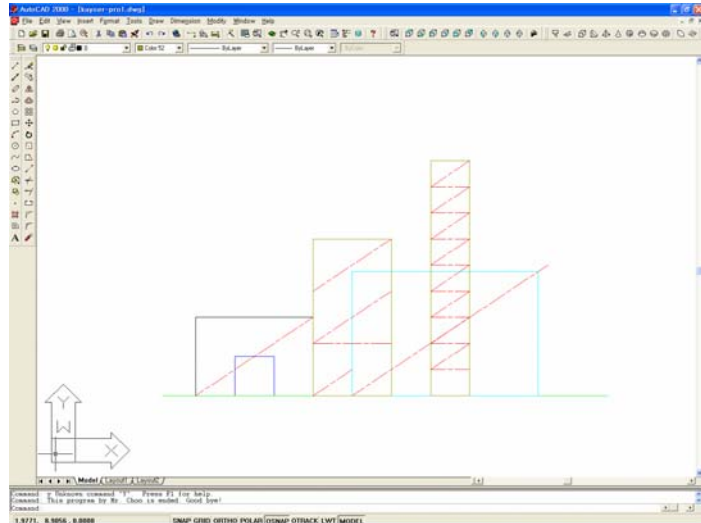

Fig.147 and 148 show the optimization of floor-plan using the programme. The designer can also use this programme when he wants to regulate the size of the blocks. The optimum harmonious relationship between each block in the floor-plan is also achieved by the diagonal regulating lines programme.

Fig.147 Floor-plan of an elementary school

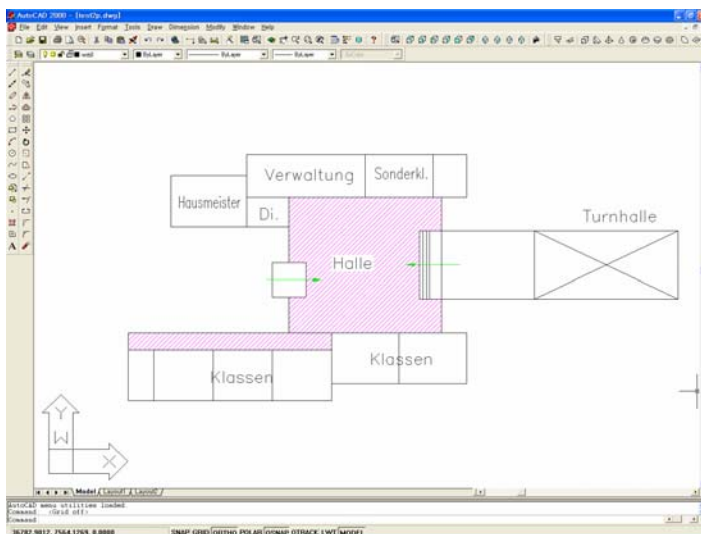
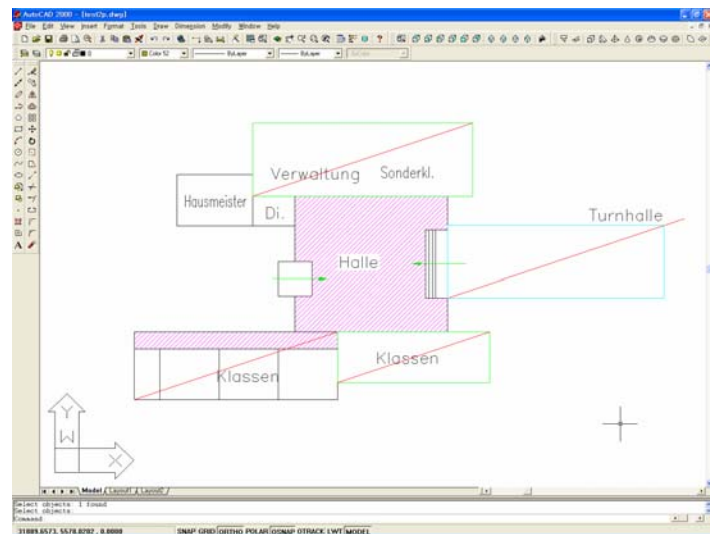

Fig.148 Optimization of the floor-plan using the diagonal regulating lines



### 5.5.2 Harmonious Proportion

As mentioned above, proportion is one way of improving the quality of a design. This theory concerns the figure ground rule for achieving an optically perfect form. The programme is also implemented in AutoCAD, and tests the plan with respect to the specific harmonious ratio which the user selects for himself. The basic proportion becomes, in this programme, a unit of measurement through which the other architectural elements of the building are examined as to whether each applied proportion achieves a harmonious relationship with the other proportions. Fig.149 illustrates a façade of a building. Fig.150 depicts the process concerned with the position of the modified size of the window. The position of the elements follows the rule which is described in Section 5.4.4.

Fig. 151 shows the optimized façade that was examined using the same unit of measurement as in the left main block. This programme is suitable, in particular, for testing the façade of a building.

Fig.149 A façade of a building

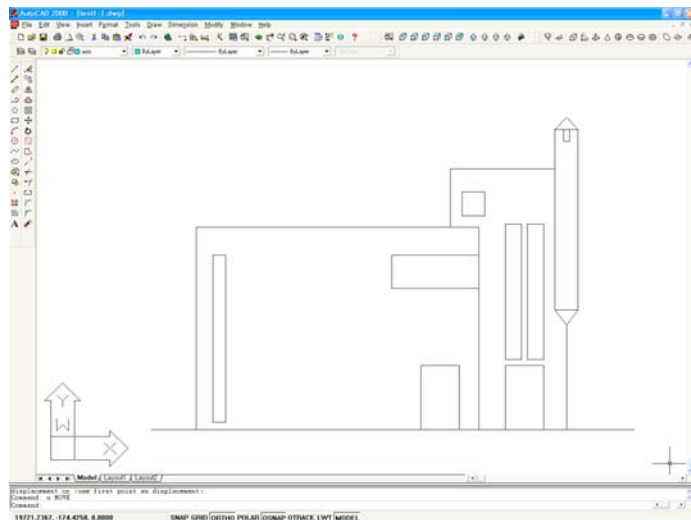

Fig.150 Position of elements in a façade

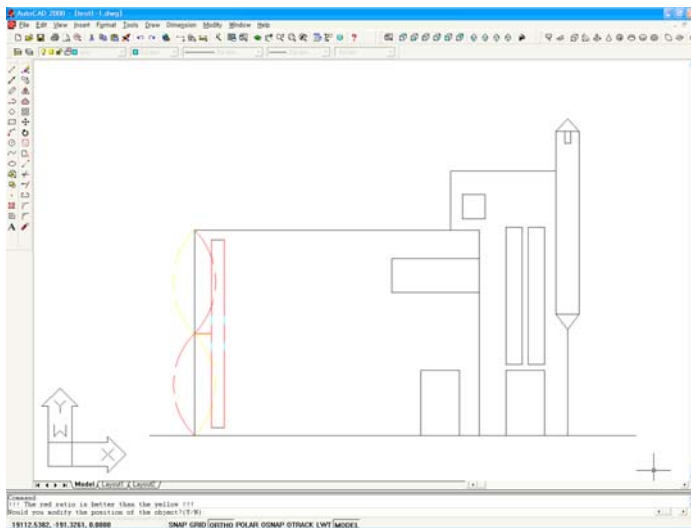
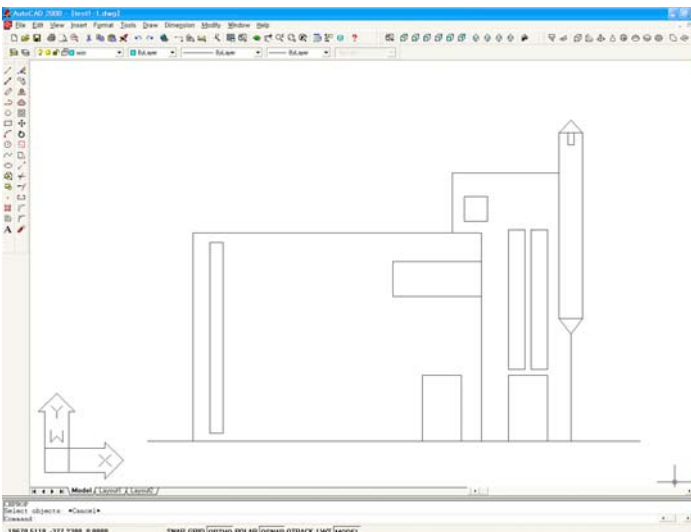

Fig.151 Result after using the programme



### 5.5.3 Musical Proportion

There has been an effort to apply musical harmony to architectural façades, to the composition of the buildings' parts and to space, from ancient periods to today.

This programme presents one way in which the relationship of a musical harmony is applied to architectural appearance. The figure in Fig. 152 seems to be monotonous because of the regular placement of columns. It has a lack of rhythmic feeling. The façade can be changed via the programme using the following melody, as in Fig.153; G, E, A, C, A, E and G.

Fig.152 Monotonous placement of columns

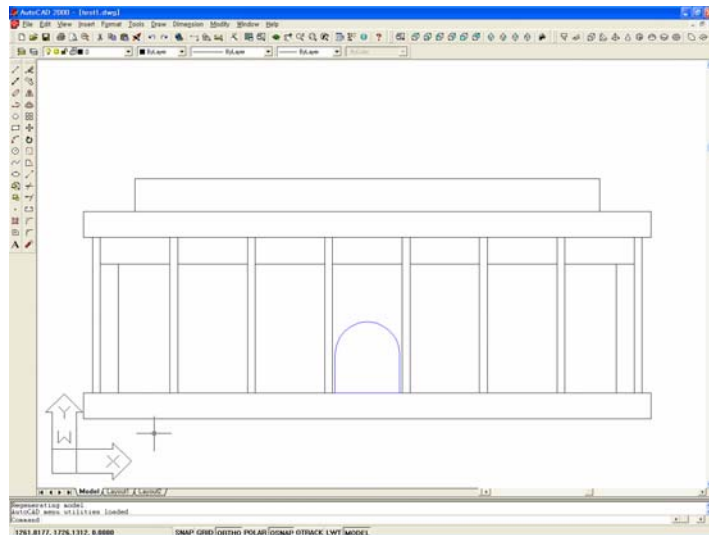

Fig.153 Rhythmic placement of columns after using the programme

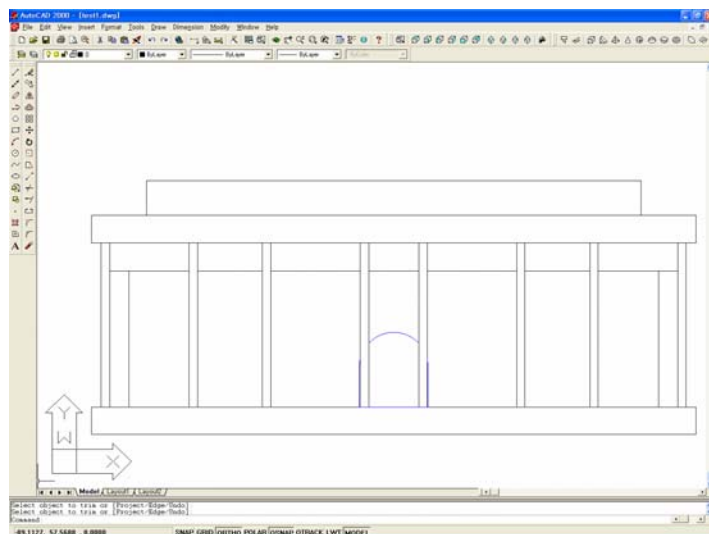



Fig.154 View from the Hofstallgasse, Salzburg



Fig.155 Model photo of the museum

This programme has been tested on a normal design project in collaboration with an architect from the early phase of the façade design to the details. As soon as the data of the musical notes are entered, the alternatives are created and then the user can choose his favourite from them. Fig.156 illustrates a façade of a museum that is being constructed now (2003) in Austrian Salzburg, which is the hometown of the worldwide famous musician “Wolfgang Amadeus Mozart”. This author received a design commission from the managing architect of that building to design the façade, which consists of natural stones and joint surfaces between them, based on a familiar piece of music by Mozart, via the programme. The function of this programme is to change the musical melody in proportion to the distance between joint surfaces.

Fig.157 shows example façades that are based on Mozart’s opera “Don Giovanni”. One can create a lot of alternative designs using this programme.

Fig.156 The east façade of the museum in Salzburg

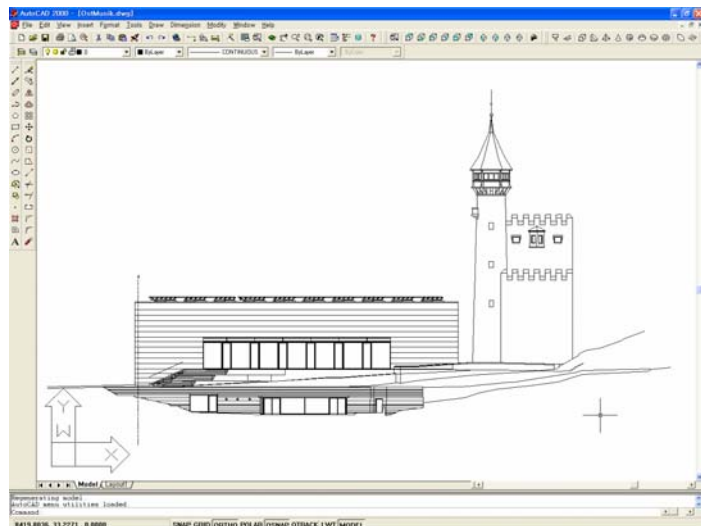
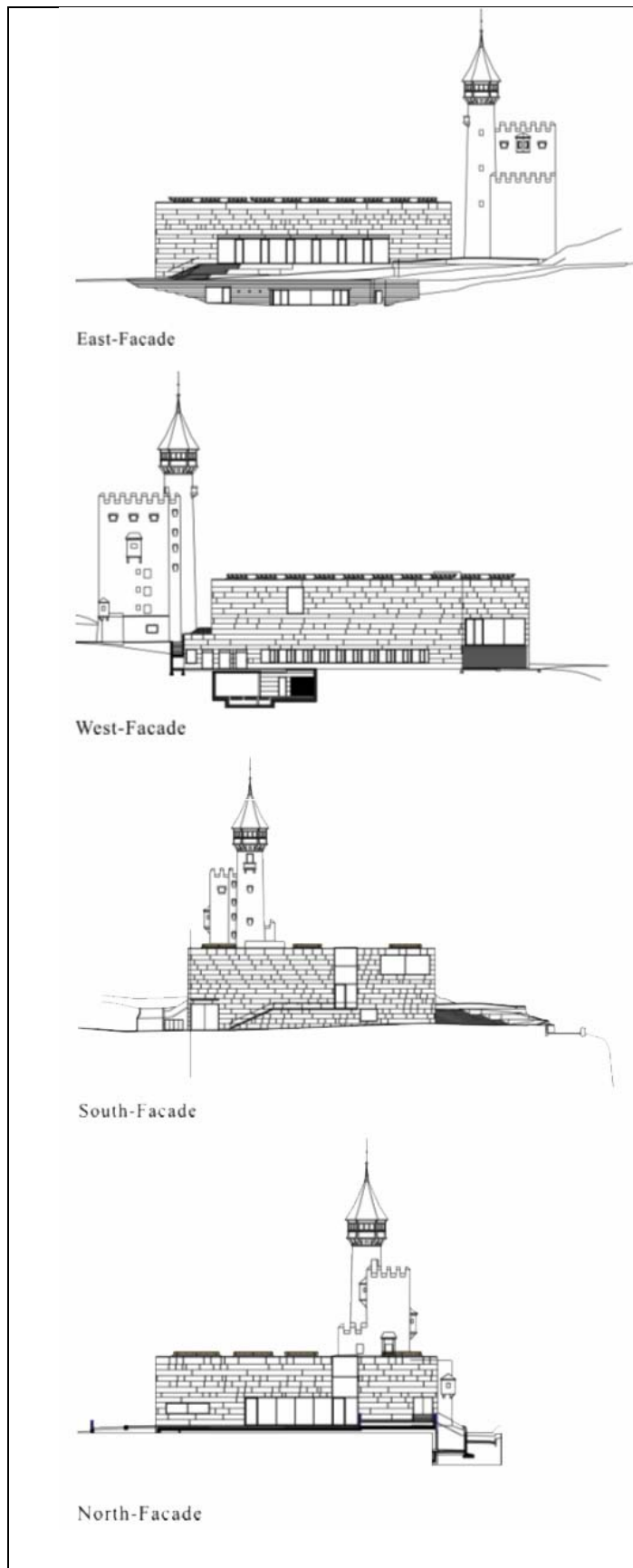



Fig.157 Applying the music to the east, west, south and north façade



---

#### 5.5.4 Harmonious Relationship between Columns and Spacing

This subsystem starts with the following question:

*If all elements of a building were composed of proportions harmonious with each other, would the space applied to them be harmonious?*

As we can see in Chapter 3, Van der Laan's proportional system could be a good solution to this question, as his series of numbers have harmonious relationships with each other. This programme suggests some optimum relationships between columns and spacing to the user, with respect to the specific harmonious ratios of Van der Laan. This relationship is described well, in his book "Architectonic Space".

Fig.158 illustrates the original elevation of a building. Using this programme, the designer can choose his favourite example from among those which are proposed by the computer on the screen, as shown in Fig.159. When the designer selects one, the programme inserts the selected example into the plan, deleting the old one, as shown in Fig.160.

Fig.158 Original elevation of a building

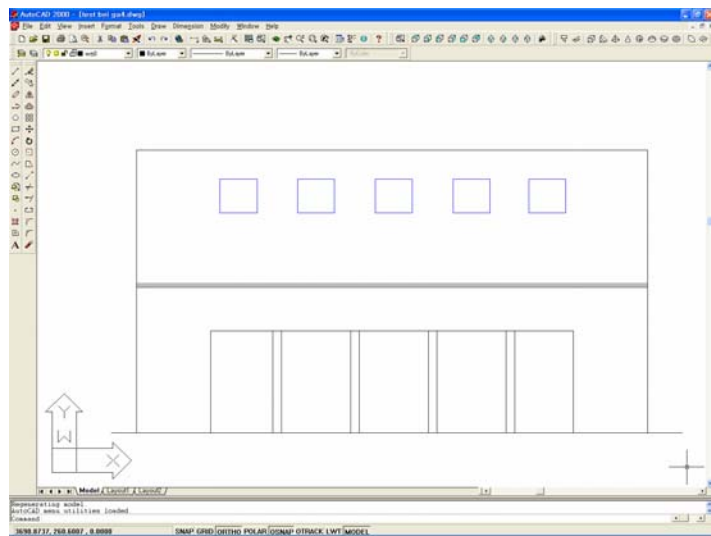

Fig.159 Alternative thickness of the columns

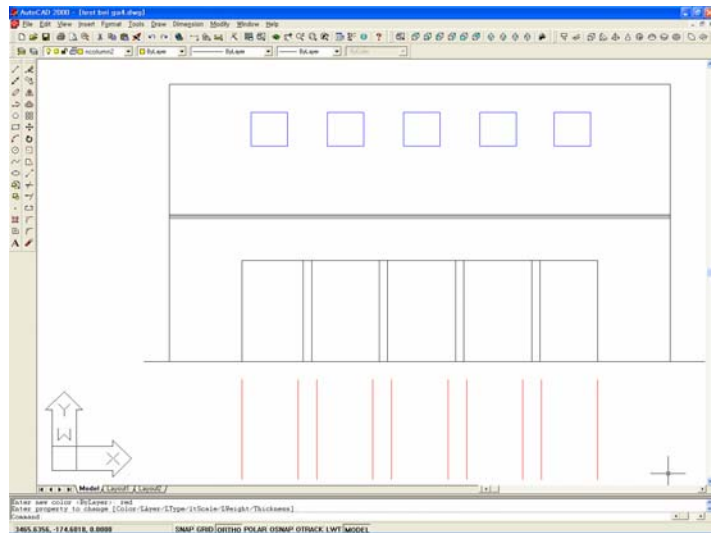

Fig.160 Result after using the programme

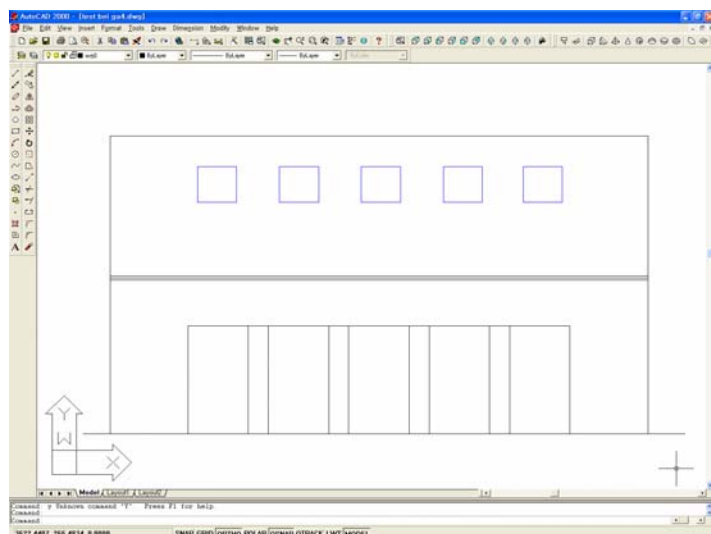

Fig.161 shows the interior of a room. Computing Van der Laan's series of numbers, all elements of the interior, such as the height and the length of the room, of the door, of the window and of the radiator, can be compared to the Plastic Number which is illustrated in the following Fig.162.

So far, the world of architecture has not offered a full answer to the above-posed question. It is hoped that we will be able to design buildings using the harmonious ratios easily, test the quality of buildings, and then seek the answer to the question, by using this programme.

Fig.161 Interior of a room

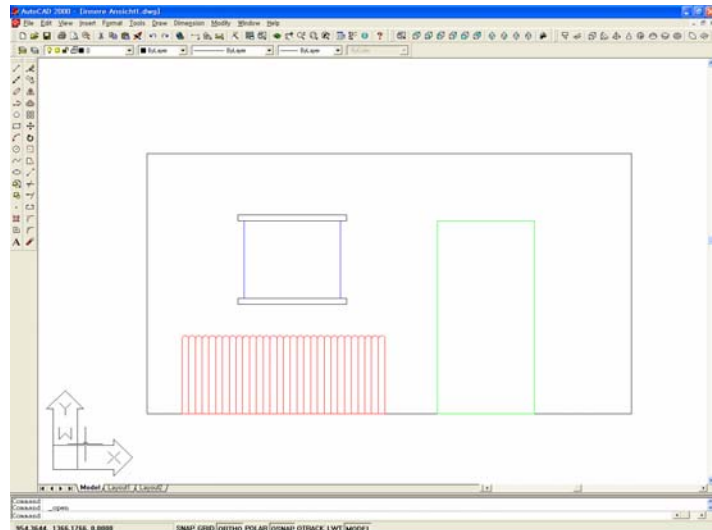
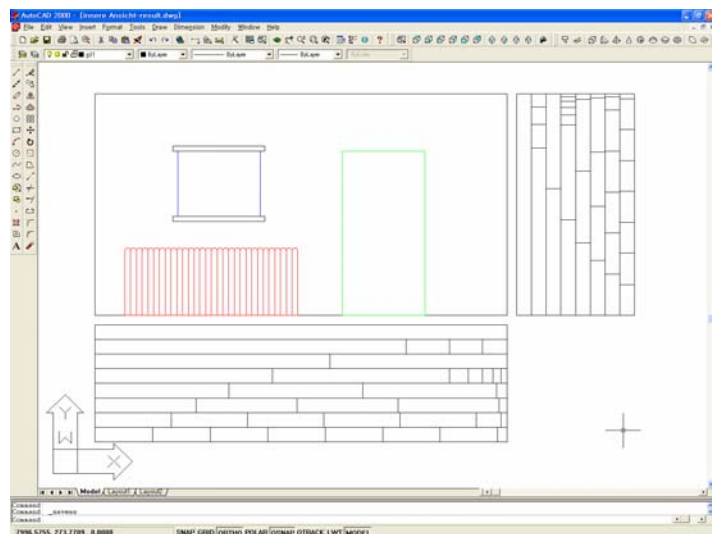

Fig.162 Recommended series of the Plastic Number in the interior of the room



---

## 5.6 Discussion

As shown in the previous examples, the application system is applied to explain and develop aesthetic qualities of a design. Designs proposed by this system include optimum designs, which are based on the traditional architectural theories, and on new ones which can be connected to the information model. The simple, visual rules used to develop designs are meant to explain how the designs are improved.

Some problems are encountered during these tests. This proposed system has not been developed under the object-orientated CAD system, so that there are only series of lines, when any elements such as windows, doors, walls and roofs, are drawn in the existing CAD system; when one draws the outline of a shape, the drawing is always a line. This means that users must select each line that encloses an element in order to examine the relationship, for instance, between windows on a façade when implementing the programme; each length or height of an element must be also chosen by users clicking the mouse on the screen. However, the world's big CAD vendors, such as Autodesk, Graphisoft and Nemetschek, have recently started to offer object-based software, including the IFC2x model. They offer powerful CAD capabilities and significant building-design tools; e.g. when we add openings to a wall in this CAD software, the wall automatically adjusts itself to accommodate the openings and adds end-caps where needed. If we move the wall, the openings move with it. If we remove an opening from a wall, the wall repairs itself in the space where the opening was located.

Fig.163 Element relationship between object-based and non object-based CAD systems

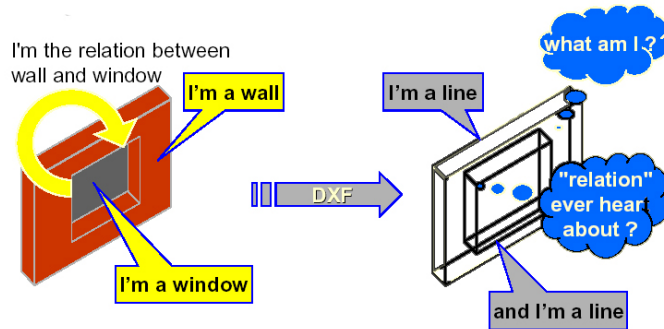

Therefore, the proposed system could be better enhanced, if it were developed using object-based CAD systems; it would neither need to select each element nor to click the length and height of an element.

This system will be very useful in object-based CAD systems, if it is integrated into the above-mentioned system, because the suggested element-set in a building, such as walls, doors, windows and roofs, is never formed, for example, according to the harmonious proportion in this CAD system, but according to the industrial standard. The design could be monotonous, if a building were constructed with these elements. By integration of the above-proposed principle, this shortcoming can be overcome.

IFC has entities concerning building elements, such as doors, windows, columns, etc., in its definition. However, the entity definition is only general purpose. A developer may need to have other attributes in addition to the attributes provided by IFC. The requisite entities for the information model, which are described in Section 5.4, are defined to support additional functions in the application system. Therefore, the entities defined by this author can be used for or applied to other applications.

## 6. CHAPTER

# Conclusion

A computer can become a design assistant to architects and engineers, only when it knows not only about drafting objects but also about design objects and their meaning in the architect's professional world. Traditional CAAD systems are the assistants to the draftsman. A new generation of CAAD's should become the architects' assistants. For such a new CAAD environment, it is a prerequisite that the system behave like a design-assistant and not a drafting tool.<sup>138</sup>

The proposed application system is part of the new CAAD environment. Our application has been implemented on the basis of the concept "computer as design assistant".

One main goal of this application system of an architectural design is the improvement of the aesthetic quality of a design, by incorporating not only geometrical, but all relevant design aspects at each design-step; in other words, this system aims to support the architectural design, based on aesthetic requirements and needs specified by architects and users. All these specifications, as well as all relevant information concerning the design are explicitly represented in this system. It contains several proposed alternative designs, showing aesthetic qualities of the objects based on the traditional design principles of architecture, thereby providing distinct

---

<sup>138</sup> R.Junge, R.Steinmann and K.Beetz, op.cit., p.628

examples of our aesthetic evaluations.

A significant part of our architectural design system is represented as design-rules, which are responsible for the implementation of the system, such as the derivation of design principles that are necessarily specified by the designer. This means that our system, just as with human architects, can specify aesthetic requirements at any design-phase.

Therefore, it is clear that the benefit of this system is that it is possible to integrate aesthetics into CAAD systems in a formal and explicit way, and that a computer itself creates and displays the optimum design alternatives on the screen, so as to meet the requirements of architectural aesthetics.

The definition of information about building elements for this application system is accomplished by using the neutral format "EXPRESS". The proposed schematic information model that is defined with EXPRESS/EXPRESS-G can be integrated into the CAAD system. In applications based on an information model, the designed objects, such as a building or its parts, are represented by a data object. Information such as ID, name, geometry, relationships and other attributes can be attached to the object. Therefore, such an information model can support the exchange of structural or other design information, provide accurate information for detailed structural design, enable 2D, 3D, and 4D visualization at various levels of detail, and support programmes being monitored during construction. In the end, the great benefit of using IFC- based information models is that it is a future orientated system and complies with the international standard. The schematic information model described in this thesis can be connected in future for design information integration and data-exchange.

Distinguishing features of the application system, in this author's opinion, are:



- *It enables the user to generate easily and quickly conceptual models and allows the user to control and rapidly change visual relationships.*
- *It enables the user to create and maintain visual control over several versions of a design and their details during the planning phase.*
- *It enables the user to easily edit the compositions by transforming them into models and applying dimensions and other geometric harmony to various parts of the model.*
- *It gives the user the basic information model for future converting the building model or plan from a purely geometric to an intelligent one.*
- *It allows the user to check the aesthetic value of a design during the various design procedures and helps in finding direction during rational searching for a solution.*

The user can easily appreciate the usefulness of the proposed system as a set of tools for searching for rational architectural aesthetics and formal solutions at different design-stages.

A building in the design-phase can be seen from a functional and a topological, as well as a geometrical point of view.<sup>139</sup>

The functional aspects are expressed in terms of usages and the topological ones are characterized by orientation (e.g., a room is located at the south side of the house) and by adjacencies in the sense that two rooms, for example, a bedroom and a bathroom, are located next to each other so as to achieve a direct connection between them (e.g., through a door). The geometric aspects are fundamental in developing and producing an architectural sketch of the house under

---

<sup>139</sup> N.M.Mattos, S.Deßloch and F.-J.Leick, A Knowledge-based Approach to Intelligent CAD for Architectural Design, Proc. Of the 4<sup>th</sup> Int. Conf. on Industrial&Engineering Applications of Artificial Intelligence&Expert Systems, Koloa, Kanai, Hawaii, 1991, p.2

design. These aspects are characterized by their attributes “positioning”, “dimension” and “size”, which relate to the harmonious theory of architecture.

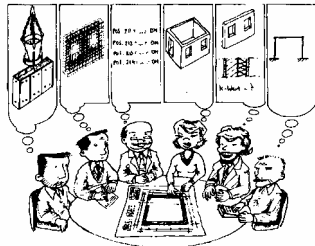

Fig.164 Collaboration today  
(Source: Prof. Richard Junge)

As we can see in this research paper, the proposed system deals with only the geometric, namely aesthetic aspect. So, a future work of mine will consist of the study of the application of the above representation-schemata, such as functional and topological aspects of a design, including investigation of the complete information model.

It is to be hoped that the results of this research will provide a useful model-approach as a new CAAD system that complements the information model for data-exchange, data-sharing and ultimately collaborative work in the AEC industry.



## Bibliography

- Alan Colquhoun, *Modernity and the Classical Tradition – Architectural Essays 1980-1987*, The MIT Press, Cambridge, 1991
- Allen A. Dorfman, *A Theory of form and proportion in music*, University of California, Los Angeles, 1986
- A.M.Bulckens, *the Parthenon's Symmetry, ISIS-Symmetry*, Sydney, 2001
- Amor R., *A UK survey of integrated project databases in Proceedings of CIB W78 Information Technology in Construction Conference*, Stockholm, 1998
- ArchiCAD, *ArchiCAD IFC Reference Guide – version 1.0*, Graphisoft R&D, 2001
- August Thiersch, *Proportionen in der Architektur in Handbuch der Architekten – Entwerfen, Anlage und Einrichtung der Gebäude*, J.M.Gebhardt's Verlag, Leipzig, 1926
- Benjamin Loomis, *SGGA – A user-driven genetic algorithm for evolving non-deterministic shape grammars*, Working Paper, MIT, 2000
- Cornelis van de Ven, *Space in Architecture – The evolution of a new idea in the theory and history of the modern movements*, Van Gorcum & Comp.B.B., Assen in the Netherlands, 1987
- Daniel Bertol, *Visualizing with CAD – An AutoCAD Exploration of Geometric and Architectural Forms*, Springer-Verlag, New York, 1994
- David A. Lauer, *Design Basics*, Holt, Reinhart and Winston, New York, 1979
- David Smith Capon, *Architectural Theory Volume Two – Le Corbusier's Legacy*, John Wiley & Sons, Chichester, 1999
- David Thomas Loffredo, *Efficient Database Implementation of EXPRESS Information Models*,

Rensselaer Polytechnic Institute, Troy/New York, 1998

- David Watkin, *Morality and Architecture – The Development of a Theme in Architectural History and Theory from the Gothic Revival to the Modern Movement*, Oxford University Press, Oxford, 1977
- Douglas Schenck and Peter Wilson, *Information Modelling – The EXPRESS Way*, Oxford University Press, New York, 1994
- Eastman C. and G. Augenbroe, *Product modeling strategies for today and the future in Proceedings of CIB W78 conference*, Stockholm, 1998
- Edward A. Lippman, *Musical thought in ancient Greece*, Columbia University Press, New York and London, 1964
- Ellen Shoshkes, *The Design Process – Case Studies in Project Development*, Architecture Design and Technology Press, London, 1990
- Ernst Neufert, *Bauentwurfslehre*, Vieweg Verlag, Wiesbaden, 1996
- Felix Jakob Metzger, *Produktdaten-Design und Daten-Integration durch Zusammenfügen autonomer Schema-Module*, ETH-Dissertation, Zürich, 1997
- Francis D.K. Ching, *Architecture – Form, Space & Order*, Van Nostrand Reinhold Company, New York, 1979
- Frank H. Mahrke, *Color, environment and human response*, Van Nostrand Reinhold Company, New York, 1996
- Frank Lloyd Wright Foundation, translated by Peter Prange, *Ausgeführte Bauten und Entwürfe von Frank Lloyd Wright*, Verlag Ernst Wasmuth Tübingen, Meisenheim/Glan, 1986
- Friedrich W. Treu, *Versuch einer quantitative Bestimmung der Wirkung des architektonischen Raumes*, Dissertation an der TU Hannover, 1970
- George F.W. Hegel, *Einleitung in die Ästhetik*, München, 1967
- Gerhard Schmitt, *Architectura et Machina – Computer Aided Architectural Design und Virtuelle Architektur*,

Verlag Viewig, Braunschweig/Wiesbaden, 1993

- Gerhard Schmitt, CAAD, Working paper for Sommersemester'93, ETH, Zürich, 1993
- Gerhard Scholz, Heterogene konzeptuelle Modelle und Interoperabilität im Elektronischen CAD, VDI Verlag GmbH, Düsseldorf, 1996
- György Doczi, Die Kraft der Grenzen – Harmonische Proportionen in Natur, Kunst und Architektur, Deutsch von Uta und Stefan Szyszkowitz, München, 1984
- Hans Junecke, Die wohlbemessene Ordnung – Pythagoreische Proportionen in der historischen Architektur, Verlag der Beeken, Berlin, 1982
- Hans Kayser, Lehrbuch der Harmonik, Occident-Verlag, Zürich, 1950
- Harald Küppers, Harmonielehre der Farben – Theoretische Grundlagen der Farbgestaltung, DuMont Buchverlag, Köln, 1989
- Heiner Knell, Vitruvius Architekturtheorie – Versuch einer Interpretation, Wissenschaftliche Buchgesellschaft, Darmstadt, 1985
- Institut für Grundlagen der modernen Architektur und Entwerfen, Beiträge zum Entwerfen, Karl Krämer Verlag, Stuttgart, 1991
- Jack Belzer, Albert G. Holzman and Allen Kent, Encyclopedia of Computer Science and Technology, University of Pittsburger, Pittsburger, 1976
- James Steele, Architektur und Computer – Planung und Konstruktion im digitalen Zeitalter, Verlag Callway, München, 2001
- J.A.N. Lee, International Biographical Dictionary of Computer Pioneers, Fitzroy Dearborn Publishers, London, 1995
- Jeffrey Wix, Industry Foundation Classes Release 2.0 – An introduction to the International Alliance for Interoperability and the Industry Foundation Classes, IAI, 1999

- Jeffery Wix and Thomas Liebich, Industry Foundation Classes – Architecture and Development Guidance, IAI, 1999
- Joachim Krause and Claude Lichtenstein, R.Buckminster Fuller – Design als Kunst einer Wissenschaft, Verlag Lars Müller, Zürich, 2001
- Johannes Itten, Der Farbstern, Otto Maier Verlag, Ravensburg, 1985
- Johannes Itten, Kunst der Farbe, Otto Maier Verlag, Ravensburg, 1970
- John Gage, Colour and Meaning – Art, Science and Symbolism, University of California Press, Los Angeles, 1999
- John McHale, R.Buckminster Fuller – Architekten von Heute, Otto-Maier Verlag, Ravensburg, 1964
- Joseph A. Gatto, Elements of Design, Colour and Value, Davis Publications, 1974
- Jörg Kurt Grütter, Ästhetik der Architektur – Grundlagen der Architektur – Wahrnehmung, Kohlhammer, Berlin, 1987
- Jürgen Joedicke, Raum und Form in der Architektur – Über den behutsamen Umgang mit der Vergangenheit, Karl Krämer Verlag, Stuttgart, 1985
- Kim Williams, NEXUS II - Architecture and Mathematics, Edizioni Dell'erba, Italy, 1999
- Le Corbusier, translated by Frederick Etchells, Towards a New Architecture, Dover Publication, New York, 1986
- Le Corbusier, The Modulor, Faber & Faber, London, 1961
- Leon Battista Alberti, The 1755 Leoni Edition, The Ten Books of Architecture, Dover Publication, New York, 1986
- Lionel March, Architectonics of Humanism – Essay on number in architecture, Academy Editions, New York, 1998
- Lionel March and Judith Sheine, RM Schindler – Composition and Construction, The Academy Group Ltd, New York, 1995

- Mahnke and Frank H., Colour, Environment and Human Response – An Interdisciplinary Understanding of Colour and its Use as a Beneficial Element in the Design of the Architectural Environment, Van Nostrand Reinhold Company, New York, 1996
- Malcolm McCullough, William J. Mitchell and Patrick Purcell, The Electronic Design Studio, The MIT Press, Cambridge, 1990
- Max Bense, Einführung in die informationstheoretische Ästhetik – Grundlegung und Anwendung in der Texttheorie, Rowohlt Taschenbuch Verlag, Reinbek bei Hamburg, 1969
- Nicholas Negroponte, The Architecture Machine – Toward A More Human Environment, The MIT Press, Cambridge, 1970
- Otmar Geckenberger, Farbenlehre für Handwerksberufe, Deutsche Verlags-Anstalt, Stuttgart und München, 2001
- Otto Fiederling, Theorie des Entwerfens – Das Entstehen des Architektorentwurfs, Curt R. Vincentz Verlag, Hannover, 1975
- Otto Schubert, Gesetz der Baukunst, Veb E.A. Seemann Verlag, Leipzig, 1954
- Patricia Sloane, The visual nature of colour, Design Press, New York, 1989
- Paul Renner, Ordnung und Harmonie der Farben, Otto Maier Verlag, Ravensburg, 1947
- Paul von Naredi-Rainer, Architektur und Harmonie – Zahl, Maß und Proportion in der abendländischen Baukunst, Dumont Buchverlag, Köln, 1982
- Peter F. Smith, Architecture and the human Dimension, George Godwin Limited, London, 1979
- Peter F. Smith, The Syntax of Cities, Hutchinson of London, London, 1977
- Peter R. Wilson, A Short History of CAD Data Transfer Standard, IEEE Computer Graphics and Applications, Vol.7, No.6, 1987

- Pierre von Meiss, Elements of Architecture – From Form to Place, E&FN Spon, London, 1990
- P.H.Scholfield, The Theory of Proportion in Architecture, Cambridge University Press, London, 1958
- Rapport A., Design Methods in Architecture, Lund Humphries, London, 1969
- Richard Junge, Aspects of new CAAD Environments in Proceedings of CIB W78 Workshop on Modeling of Buildings through their Life-Cycle, Stanford University, Stanford, 1995
- Richard Junge (ed.), CAAD futures '97, Kluwer Academic Publishers, Dordrecht, 1997
- Richard Junge and Thomas Liebich, Product Modeling for Applications – Models for Next Generation CAAD in Proceedings of sixth International Conference on Computing in Civil Engineering, Rotterdam, 1995
- Richard Padovan, Dom Hans Van der Laan – Modern Primitive, Architectura&Natura Press, Rotterdam, 1994
- Richard Padovan, Proportion – Science, Philosophy, Architecture, E&FN Spon, London and New York, 1999
- Rob Krier, Über architektonische Komposition, Klett-Cotta, Stuttgart, 1989
- Robert Noak, Converting CAD Drawings to Product Models, Royal Institute of Technology, Stockholm, 2001
- Rudolf Arnheim, Die Dynamik der architektonischen Form, Dumont Buchverlag, Köln, 1980
- Rudolf Wienands, Grundlagen der Gestaltung zu Bau und Stadtbau, Birkhäuser, Basel, 1985
- Rudolf Wittkower, Grundlagen der Architektur im Zeitalter des Humanismus, Deutscher Taschenbuch Verlag, München, 1983
- Sevil Sariyildiz, Improving CAAD by Applying Integrated Design Support Systems and New Design Methodologies in CAAD futures 1997, Kluwer Academic Publishers, Dordrecht, 1997
- Shih S.G. and G. Schmitt, The Use of Post-interpretation for



Grammar-based Generative Systems in Proceedings International Workshop on Formal Design Methods for CAD, 1993

- Stephen R. Wassell, The Mathematics of Palladio's Villas, NEXUS II - Architecture and Mathematics, Edizioni Dell'erba, Italy, 1999
- Terry W. Knight, Transformations in design – A formal approach to stylistic change and innovation in the visual arts, Cambridge University Press, Cambridge, 1994
- Thomas Liebich, Wissensbasierter Architektorentwurf – Von den Modellen des Entwurfs zur einer intelligenten Computerunterstützung, Dissertation at the Hochschule für Architektur und Bauwesen Weimar, 1993
- Thomas Thilo, Klassische chinesische Baukunst – Strukturprinzipien und soziale Funktion, Edition Tusch, Wien, 1977
- Trevor Lamb and Janine Bourriau, Colour – Art & Science, Cambridge University Press, Cambridge, 1995
- Ulrich Flemming, Case-based design in the SEED system, Knowledge-based Computer-aided Architectural Design, 1994
- Van der Laan, translated by Richard Padovan, Architectonic Space – Fifteen lessons on the disposition of the human habitat, E.J. Brill, Leiden,
- Vitruvius, edited by Ingrid D. Rowland and Thomas Noble Howe, The Ten Books on Architecture, Cambridge University Press, Cambridge, 1999
- Volker Fischer, Nicholas Grimshaw&Partners Halle 3, Messe Frankfurt am Main, Edition Axel Menges, Stuttgart/London, 2002
- Werner Sommer, AutoCAD 2000 – Kompendium, Markt&Technik Verlag, München, 1999
- William J. Mitchell, Computer-Aided Architectural Design, Van Nostrand Reinhold Company, New York, 1977
- William J. Mitchell, e-topia – Urban life, Jim – but not as we know it, The MIT Press, Cambridge, 1999

- William J. Mitchell, The Logic of Architecture – Design, Computation, and Cognition, The MIT Press, Cambridge, 1990
- William J R Curtis, Le Corbusier – Ideas and Forms, Phaidon Press Ltd, London, 1986
- Wolfgang Metzger, Gesetze des Sehens, Verlag Waldemar Kramer, Frankfurt, 1975
- Wolfgang Storm, Zum Stand und zur Bewertung der Trocknungsprozesse und Trocknungsanlagen in der Silikatindustrie – dargestellt am Beispiel der Trocknung feinkeramischer Werkstoffe, Dissertation der Hochschule für Architektur und Bauwesen Weimar, 1987
- Yoshinobu Ashihara, Exterior Design in Architecture, Van Nostrand Reinhold Company, New York, 1970
- Arch+, September 1995
- LA Times, October 17
- Verband der deutschen Bauindustrie, 1998
- Verband der Projektsteuerer
- <http://deslab.mit.edu/DesignLab/dicpm/step.html>
- <http://cic.nist.gov/>
- <http://cic.vtt.fi/links/step.html>
- [http://cig.bre.co.uk/iai\\_uk/](http://cig.bre.co.uk/iai_uk/)
- <http://italab.khu.ac.kr/>
- <http://vitruvius.itu.edu.tr>
- <http://www.arch.columbia.edu/DDL/research/ddl.human.html>
- <http://www.cecer.army.mil/EARUpdata/NLFiles/2000/>
- <http://www.epmtech.com/>
- <http://www.descomp.mit.edu>
- <http://www.iai-international.org>
- <http://www.nist.gov/sc4/>
- <http://www.prostep.com/de/>
- <http://www.rib.de/unternehmen/historie/>
- <http://www.steptools.com/projects/niiip>