

A decorative graphic on the left side of the cover, featuring a series of overlapping, curved, light blue shapes that resemble a stylized fan or a series of overlapping pages, set against a dark blue background.

# Annual Report

Technical University of Munich

Institute for Advanced Study

2016

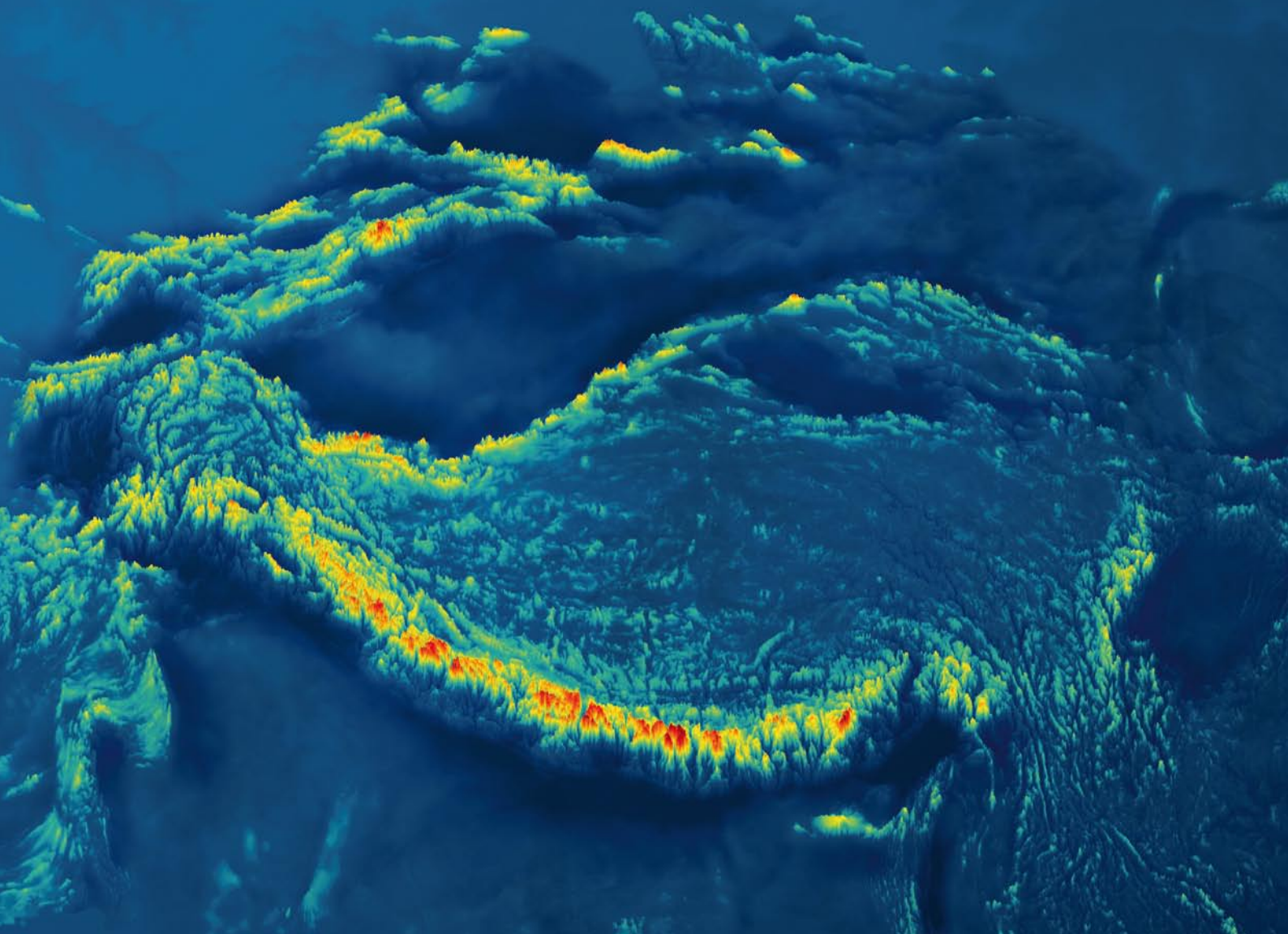





Annual Report

Technical University of Munich

Institute for Advanced Study

2016



## Table of Contents

TUM President's Foreword	4
TUM-IAS Director's Message	6
People	9
Activities and Events	19
In Focus: Interview	45
Scientific Reports	57
Publications	183
Facts and Figures	209
Index	216



Before I took the helm as TUM President more than 20 years ago, my work centered on research in my chosen field, chemistry. As both a scientist and head of a leading technical university, I've enjoyed close collaboration with partners from academia, industry, government and the public. Each time, I'm reminded anew that turning ideas into innovation doesn't happen solely within the rarified atmosphere of some academic "Ivory Tower." And transforming fundamental research into advanced applications for society at large isn't the sole domain of big business or government entities. Scientific advancement and enterprise both happen – and thrive – at exactly the place where all of these key players intersect.

Here at TUM, the past year ushered in a host of exciting developments that underscore our ongoing commitment to transforming ideas into real innovation. We further sharpened our focus on both academic and entrepreneurial excellence – at the place where science and society meet. June 2016 saw the inauguration of our new Science and Study Center Raitenhaslach, a late-Baroque monastery on the banks of the Salzach River in southeastern Bavaria. While retaining the historical structure of this cultural heritage site, we restored and transformed it into a science center inspired by sustainable internationality – to connect home with the world. The former monastery has already become a hub for discovery and interdisciplinary exchange – for students and scientists, visiting experts and dignitaries, and for the growing community of TUM-IAS Focus Group experts and alumni for whom the idyllic setting in the Bavarian countryside has become a second "home away from home" here in Germany.

Further strengthening the ties between fundamental research and society, TUM set the stage for the launch of the new TUM School of Governance in October 2016. The founding of a political science department represents a huge step forward in the further integration of the social sciences into our traditional fields of engineering, natural and life sciences and medicine. The new school is concentrated on the politics of our technicalized society, with overall research programming oriented towards the interdependence between technical progress and political processes. The rapidly increasing influence of new technologies on all our lives – from self-driving cars to social media and beyond – has turned technological issues in almost every field of policy from marginal topics into decisive factors. Our work at the intersection of technology and political science is an international rarity. In 2017, we're marking the 10th anniversary of our first Fellows at the TUM-IAS. The driving idea behind the Institute's foundation in 2005 was to give serendipity some room to play – or as I like to say, "giving chance a chance." Or as TUM Ambassador and TUM-IAS Hans Fischer Senior Fellow, Prof. Stanley Riddell, notes in the "In Focus" interview in this report, "The IAS is unique. The goal is to match an international scientist with a host scientist here for a focused area of research. And that is just not an opportunity that is always readily available."

A decade on, the TUM-IAS community of Fellows, Hosts, partners and alumni continues to show us just how much can be accomplished when we bring together the best minds from academia, industry and society – and provide them with the necessary time and space to truly “risk creativity.” As we begin the countdown to another big milestone in TUM’s history – we’ll be celebrating our 150th anniversary in 2018 – I am proud to say that our university continues to risk creativity by blazing new trails to tackle the scientific, social and technological challenges and issues of our time.



*Prof. Wolfgang A. Herrmann*  
President



As we look back on the very rewarding and fruitful year the TUM-IAS had in 2016, I am reminded of some thoughts I shared with Fellows, friends and guests in my address at the festive dinner of our 2016 General Assembly.

*If you always do what you've always done, you will always get what you've always got!*

I heard this aphorism for the very first time just a few days before the assembly – it was advice being given by a character in a TV movie. The wisdom of this deceptively simple sentiment struck a chord with me, and I started researching to find the original source. The quote is often attributed to self-help guru and “Unlimited Power” author, Anthony (Tony) Robbins. *But surely he wasn't the first person to have said this*, I thought to myself. So I dug deeper and discovered earlier references to Paul Watzlawick (1921– 2007), an Austrian communications theorist and philosopher. And before that, this pithy advice had been attributed to great thinkers such as Albert Einstein, Henry Ford and even Mark Twain. Indeed, the quote has dimensions in fields spanning poetry, innovation and entrepreneurship, science and philosophy.

For example: How would two of Twain's most beloved literary characters, Tom Sawyer and Huckleberry Finn, have found, embraced and finally survived their adventures... or how would we have launched a whole new age of unprecedented global mobility... or...how would an idea that was, at first, a purely theoretical concept (one that contradicted all experience of the visible world!) have ultimately revolutionized not only physics but many other areas... if these protagonists hadn't done *something different* than they did before?

So what does this aphorism have to do with us as scientists? *Well, let's be brutally honest: Very often, we do exactly what we've always done.* Those of us who are established, senior-level scientists have built good reputations and names in our respective scientific communities. We could still experience success without daring the risk of branching out into new areas beyond our own disciplines. Likewise for the young researchers among us, establishing a strong professional reputation will be equally important for their future careers.

And what could be a better guarantee of continued success than staying inside the box and *doing as we have always done* – to get friendly reviews of our publications, garner favor to ensure future funding and land opportunities for professional promotion and acknowledgement from our peers and the scientific community at large? We have demonstrated that we are very good – and very successful – at doing what we have always done, and it is obvious that we would be able to remain on this path by continuing to do ‘business as usual.’



Of course, this style of research to which we have become accustomed continuously produces many new results – at least in an incremental sense. And building on experience and qualification is surely an indispensable prerequisite for excellent research. But at some key points in both our lives and careers, shouldn't we risk leaving the beaten path – and take the scary leap to start exploring what was never explored before?

*If you always do what you've always done, you will always get what you've always got!* There is another sentence to this aphorism:

*If you want something you've never had, you must be willing to do something you've never done.*

This sentence has also been attributed to Watzlawick, but it (possibly) even goes back to Thomas Jefferson: As one of the founders of an all-new nation, one could say Jefferson was also a researcher risking an experiment that many said would never succeed.

And I think one could add:

*You not only must be willing, you must also wish it!*

How could a sentence better express the freedom of humans and their power to change? We must be both willing to and wish to do something new! And this is just another key concept behind the mission statement of the TUM Institute for Advanced Study:

### 'Risking Creativity'!

I wish for you – as friends and readers of this annual report, as students, Fellows, Hosts, doctoral or postdoctoral researchers or just as someone who is eager to learn and explore – that you seek out and embrace this risk of creativity. The TUM-IAS will try its best to provide the ecosystem in which your creativity can find fertile soil and the right conditions in which to prosper.



Prof. Ernst Rank  
Director



People

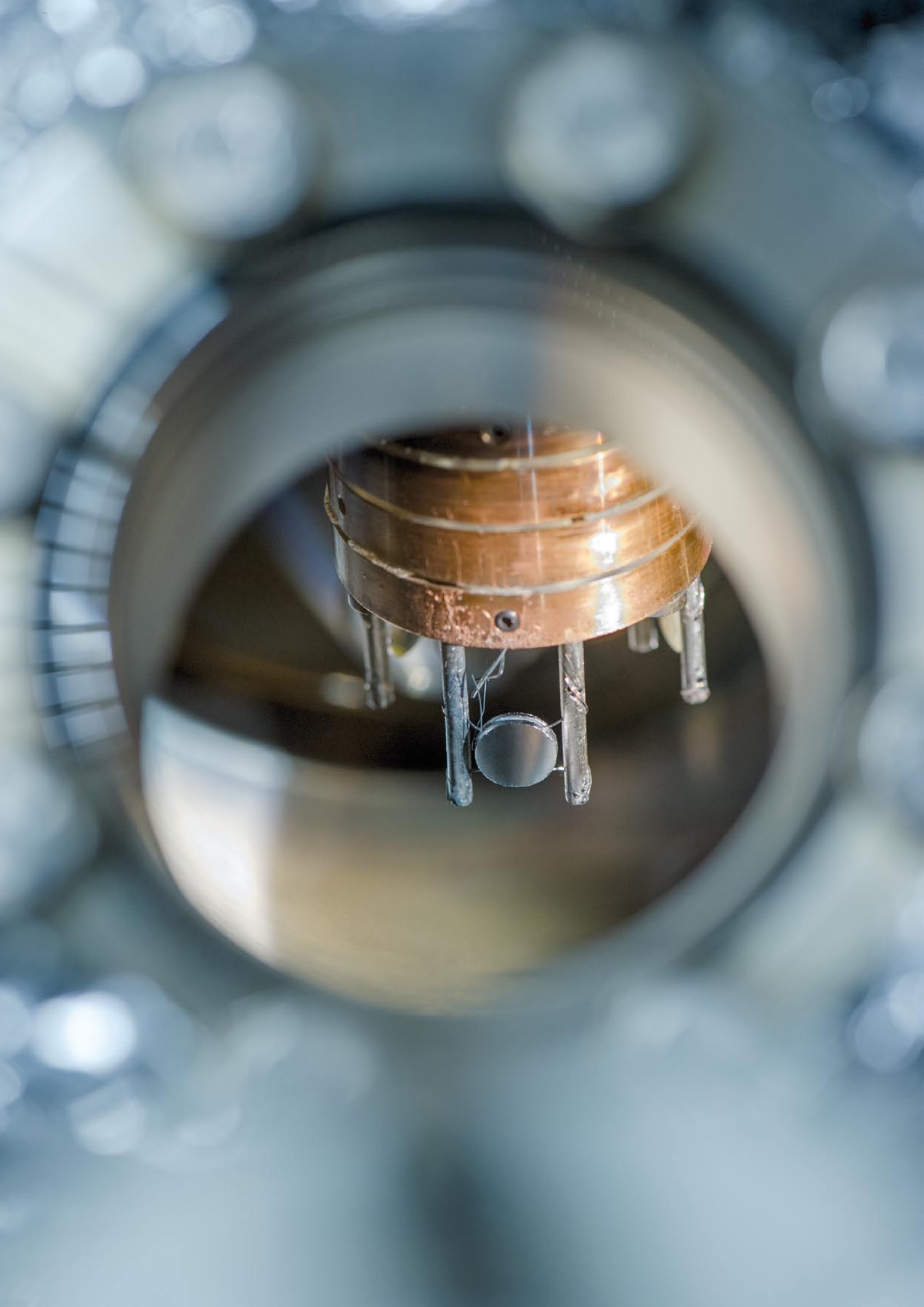

The Board of Trustees is formed by a group of international advisors from academia, research support organizations, and industry. It advises the director on general scientific, organizational, and technical issues. The Board also defines the general strategy and standards of the Institute.

## Members

**Chairman: Prof. Wolfgang A. Herrmann**

Technical University of Munich, President

**Prof. Patrick Aebischer** École Polytechnique Fédérale de Lausanne (EPFL), President

**Dr. Enno Aufderheide** Alexander von Humboldt Foundation, Secretary General

**Prof. Anders O. Bjarklev** Technical University of Denmark, President

**Prof. Martin Carrier** Bielefeld University, Faculty of History, Philosophy and Theology, Institute for Interdisciplinary Studies of Science

**Dr. Klaus Engel** Evonik Industries AG, Chairman of the Executive Board

**Prof. Heather Hofmeister, Ph.D.** Goethe University Frankfurt am Main, The Center for Leadership and Behavior in Organizations (CLBO), Scientific Director

**Dr. Ludwig Kronthaler** Max Planck Society, Secretary General

**Prof. Christine Lang** ORGANOBALANCE GmbH, CEO

**Prof. Dr.-Ing. Reimund Neugebauer** Fraunhofer Society, President

**Dr. Dorothea Rüländ** German Academic Exchange Service (DAAD), Secretary General

**Prof. Reinhard Rummel** TUM, Institute for Astronomical and Physical Geodesy, TUM Emeritus of Excellence

**Prof. Hiroyuki Sakaki** The University of Tokyo, Professor Emeritus  
Toyota Technological Institute, President

**Prof. Bert Sakmann** Max Planck Florida Institute, Inaugural Scientific Director  
Max Planck Institute of Neurobiology, Emeritus Research Group Leader,  
Nobel Prize for Physiology or Medicine 1991

**Prof. Londa Schiebinger** Stanford University, John L. Hinds Professor of the  
History of Science, Gendered Innovations in Science, Health & Medicine,  
Engineering, and Environment, Director

**Prof. Dr. med. Markus Schwaiger** TUM, University Hospital Klinikum  
rechts der Isar, Medical Director, Nuclear Medical Clinic and Polyclinic, Director

**Prof. Henry Tye** The Hong Kong University of Science and Technology,  
HKUST Jockey Club Institute for Advanced Study, Director

## Advisory Council

### 12 People

The TUM-IAS Advisory Council consists of a member from the Max Planck Institute of Quantum Optics and TUM professors covering all major fields of the university. It functions as a standing advisory board to the TUM-IAS Director and his management team. One of its prime functions is advising on the suitability and ranking of Fellow nominations the Institute receives for its various Fellowship programs. In addition, the Council advises on the scientific and technological course of the Institute, on the basis of an assessment of the potential and needs of the university. The Advisory Council meets regularly, typically about four times a year.

### Members

**Prof. Hans-Joachim Bungartz**

Chair of Scientific Computing, Graduate Dean of the TUM Graduate School

**Prof. Dirk Busch**

Institute for Medical Microbiology, Immunology and Hygiene

**Prof. Ulrich Heiz**

Chair of Physical Chemistry

**Prof. Horst Kessler**

Department of Chemistry

**Prof. Ingrid Kögel-Knabner**

Chair of Soil Science

**Prof. Gerhard Kramer**

Institute for Communications Engineering

**Prof. Katharina Krischer**

Nonequilibrium Chemical Physics

**Prof. Sabine Maasen**

Chair in the Sociology of Science, Director of the Munich Center for Technology in Society (MCTS)

**Prof. Gerhard Rempe**

Max Planck Institute of Quantum Optics - Quantum Dynamics Group

**Prof. Daniel Straub**

Engineering Risk Analysis Group

**Prof. Wolfgang Wall**

Institute for Computational Mechanics

**Prof. Isabell M. Welp**

TUM School of Management - Chair for Strategy and Organization

**Prof. Barbara Wohlmuth**

Chair of Numerical Mathematics, Director IGSSE

## Management Office



Prof. Ernst Rank  
Director



Dr. Ana Santos Kühn  
Managing Director



Eva Pettinato  
Program Manager



Tatjana Steinberger  
Program Manager



Annette Sturm  
Event Manager /  
Web Coordinator



Sigrid Wagner  
Event Manager /  
Web Coordinator



Erika Höchtl  
Secretary / Building  
Coordination



Christina Schmid  
Secretary / Guesthouse  
Coordination

### Farewells



Anna Fischer  
Program Manager  
(on maternity leave)



Juliane Strücker  
Program Manager  
(until 11/2016)

## Fellows

14	Carl von Linde Senior Fellows	2008	Prof. Horst Kessler
		2013	Prof. Annette Menzel
		2014	Prof. Martin Buss
		2015	Prof. Franz Pfeiffer
		2016	Prof. Hendrik Dietz
	Carl von Linde Junior Fellow	2013	Dr. Peer-Hendrik Kuhn
	Hans Fischer Senior Fellows	2009	Prof. Stanley Riddell
		2011	Prof. Silvio Aime, Prof. Polly L. Arnold, Prof. Daniel Gianola,
		2012	Prof. Stephen M. Goodnick, Prof. Dietmar W. Hutmacher
		2013	Prof. Harald Brune, Prof. Zvonimir Dogic, Prof. Josef P. Rauschecker, Prof. Jelena Vuckovic
		2014	Prof. John S. Baras, Prof. Dirk Bergemann, Prof. Gregory D. Hager, Prof. Tamas Horvath, Dr. Andreas Kronfeld, Prof. A. Lee Swindlehurst, Prof. Nicholas Zabaras
		2015	Prof. Carl P. Blobel, Prof. Klaus Kästner, Prof. Yannis Kevrekidis, Dr. Thierry Lasserre, Prof. Jane A. McKeating, Prof. Anca Muscholl, Prof. Ayyalusamy Ramamoorthy
		2016	Prof. Angela Casini, Prof. Krishnendu Chakrabarty, Prof. Johannes Lehmann; Prof. Bernhard Schrefler (awarded by the TÜV Süd Foundation)
	Hans Fischer Fellows	2012	Prof. George Biros
		2013	Prof. Matthias Batzill, Dr. Christian Hirt
		2014	Prof. Yana Bromberg, Prof. Tsung-Yi Ho, Prof. Stuart Khan, Prof. Suljo Linic
		2015	Dr. Kaye S. Morgan, Prof. Alessandro Reali, Prof. Dominique Sugny
		2016	Prof. Jochen Blumberger, Dr. Marc Janoschek, Dr. Melike Lakadamyali
	Rudolf Diesel Industry Fellows	2012	Dr. René-Jean Essiambre, Prof. Michael Friebe, Dr. Bruno Schuermans
		2013	Dr. Thomas Koehler, Dr. Peter Lamp
		2014	Dr. Norman Blank, Dr. Heike Riel
		2015	Prof. Carlo Ratti
	Rudolf Mößbauer Tenure Track Professors	2013	Prof. Kathrin Lang, Prof. Bjoern Menze, Prof. Alessio Zaccone
		2014	Prof. Jia Chen, Prof. Matthias J. Feige, Prof. Franz Hagn, Prof. Michael Knap, Prof. Robert König
		2015	Prof. Job Boekhoven, Prof. Carlo Camilloni, Prof. Frank Johannes, Prof. Rolf Moeckel
		2016	Prof. Stephan Günnemann, Prof. Sebastian Steinhorst, Prof. Antonia Wachter-Zeh
	Anna Boyksen Fellows	2014	Prof. Madeleine Heilman
		2015	Prof. Giovanni Boniolo, Prof. Regina Ensenaer, Prof. Sarah de Rijcke
		2016	Prof. Nicola Lautenschlager



## Alumni Fellows

Carl von Linde Senior Fellows	2007	Prof. Andrzej Buras, Prof. Arthur Konnerth, Prof. Reiner Rummel	15
	2008	Prof. Claudia Klüppelberg	
	2009	Prof. Axel Haase	
	2010	Prof. Ulrich Stimming, Prof. Gerhard Abstreiter	
	2011	Prof. Ingrid Kögel-Knabner	
Carl von Linde Junior Fellows	2007	Prof. Adrian Jäggi	
	2008	Dr. Martin Gorbahn, Dr. Ulrich Rant, Prof. Robert Stelzer	
	2009	Prof. Kolja Kühnlenz, Dr. Marco Punta, Dr. Ian Sharp, Prof. Julia Kunze-Liebhäuser	
	2010	Prof. Wilhelm Auwärter, Dr. Vladimir García Morales, Prof. Alexandra Kirsch, Prof. Miriam Mehl, Dr. Christian Stemberger, Prof. Dirk Wollherr	
	2011	Prof. Angelika Peer, Prof. Dongheui Lee	
Hans Fischer Senior Fellows	2007	Prof. Gerhard Beutler, Prof. Walter Kucharczyk, Prof. Bert Sakmann	
	2008	Prof. Anuradha M. Annaswamy, Prof. Yasuhiko Arakawa, Prof. Douglas Bonn, Prof. Mandayam A. Srinivasan, Prof. David A. Weitz	
	2009	Prof. Matthew Campbell, Prof. Richard Davis, Prof. Gino Isidori, Prof. Shuit Tong Lee, Prof. Wolfgang Porod, Prof. Peter Schröder, Prof. Zohar Yosibash	
	2010	Prof. Robijn Bruinsma, Prof. Markus Hegland, Prof. Michael Ortiz, Prof. Stefan Pokorski, Prof. Tim Sparks, Prof. Raman I. Sujith	
	2011	Prof. Frank R. Kschischang, Prof. Christian Werthmann	
	2012	Prof. Dietmar W. Hutmacher	
Hans Fischer Fellow	2012	Prof. Franz Hagn	
Hans Fischer Tenure Track Professors	2007	Prof. Thomas Misgeld	
	2010	Prof. Hendrik Dietz	
Rudolf Diesel Industry Fellows	2009	Prof. Khaled Karrai, Dr. Dragan Obradovic, Dr. Georg von Wichert	
	2010	Dr. Tsuyoshi Hirata, Prof. Gernot Spiegelberg, Dr. Matthias Heller, Dr. Chin Man W. Mok	
	2012	Dr. René-Jean Essiambre	
	2014	Dr. Norman Blank	
Rudolf Mößbauer Tenure Track Professor	2013	Prof. Alessio Zaccone	

## Honorary Fellows 2016

16 Alexander von Humboldt  
Research Awardees  
Honorary Hans Fischer  
Senior Fellows

Prof. Mikhail A. Belkin | University of Texas at Austin  
Prof. Steffen Lauritzen | University of Copenhagen  
Prof. Andrzej Ludwik Sobolewski | Polish Academy of Sciences

### ERC Grantees

Prof. Andreas Bausch | Cellular Biophysics, TUM  
Dr. Tim Czopka | Neuronal Cell Biology, TUM  
Prof. Hendrik Dietz | Biomolecular Nanotechnology, TUM  
Prof. Ville Kaila | Computational Biocatalysis, TUM  
Prof. Thomas Neumann | Database Systems, TUM  
Prof. Stephan A. Sieber | Organic Chemistry II, TUM  
Prof. Konrad Tiefenbacher | Organic Chemistry, TUM  
Prof. Rüdiger Westermann | Computer Graphics and Visualization, TUM  
Dr. Agnieszka Wykowska | Cognitive Systems, TUM  
Prof. Xiaoxiang Zhu | Signal Processing in Earth Observation, TUM

### Gottfried Wilhelm Leibniz Prizewinner

Prof. Daniel Cremers | Computer Vision, TUM

### August-Wilhelm Scheer Visiting Professors

Dr. Marta Cristina Antonelli | Universidad de Buenos Aires  
Prof. Mark Balas | Embry-Riddle Aeronautical University  
Prof. Joseph Z. Ben-Asher | Technion – Israel Institute of Technology  
Prof. Edson Bim | Universidade Estadual de Campinas  
Prof. Poul Hendrik Bredahl Sorensen | University of British Columbia  
Prof. Alexey Bulgakov | South-Russian State Polytechnic University  
Prof. Fernando Corinto | Politecnico di Torino  
Prof. Randy E. Ellis | Queen's University  
Prof. Barry Goodell | Virginia Polytechnic Institute and State University  
Dr.-Ing. Jörn von Grabe | University of Liechtenstein  
Prof. Andrey Grigoriev | Rutgers University  
Prof. Zonghua Gu | Zhejiang University  
Prof. Ahmed Helmy | University of Florida  
Prof. John J. Kanet | University of Dayton  
Prof. Jürgen Konczak | University of Minnesota

Prof. David M. Lapola | São Paulo State University  
Prof. Petra Liedl | The University of Texas at Austin  
Prof. Nghiem Long | University of Wollongong – Australia  
Prof. Cliff Mallett | The University of Queensland  
Prof. Sanjoy K. Mitter | Massachusetts Institute of Technology  
Prof. Christine Nash | University of Edinburgh  
Prof. Marina A. Petrukhina | University at Albany  
Prof. Wolfgang Porod | University of Notre Dame  
Dr. Catherine Powell | University of Manchester  
Prof. Predrag Radivojac | Indiana University  
Dr. Cornelia Rumpel | Institute of Ecology and Environmental Sciences Paris  
Prof. Sinéad M. Ryan | Trinity College Dublin  
Prof. Rayan Saab | University of California, San Diego  
Prof. Anastasios Stamou | National Technical University of Athens  
Prof. R. I. Sujith | IIT Madras  
Prof. P. S. Thiagarajan | Harvard Medical School  
Prof. Tejs Vegge | Technical University of Denmark  
Prof. Sharav Tumenjargal | Mongolian University of Life Sciences

## Visiting Fellows 2016

Prof. Gabor T. Herman | City University of New York  
Prof. Mari Kobayashi | Centrale Supélec, Gif-sur-Yvette  
Prof. Pierre Moulin | University of Illinois at Urbana-Champaign  
Prof. Andrew C. Singer | University of Illinois at Urbana-Champaign





## TUM-IAS General Assembly

April 28–29, 2016

The TUM-IAS General Assembly plays a key role in establishing connections between Fellows, Hosts and members of the TUM-IAS community across all disciplines. Over the course of two days, assembly participants have the opportunity to engage in scientific discussions during the talks and poster sessions – or more informally at coffee and lunch breaks.

At the 2016 meeting, topics ranged from dynamic supramolecular materials, and modeling the Earth's gravity to 3-D computer vision, sterile neutrinos and dark matter, and gendered innovations in science and technology. Once again, the diverse range of fascinating research topics both underscored and highlighted the true interdisciplinary nature of the Institute. It is always a pleasure to observe researchers coming from completely different fields engaging in lively discussions and discovering commonalities in their research they had, perhaps, never considered before. In many cases, “non-obvious” collaborations have their starting point at this event.

During the conference dinner, as has been tradition since the founding of the Institute, the new members of the TUM-IAS community were announced, this past year by the Vice President for International Alliances and Alumni, Prof. Hana Milanov. In her dinner address, she emphasized the important role TUM-IAS plays in the sustainability of TUM's international strategy. Hana Milanov also highlighted a few of the many TUM-IAS success stories in international collaboration via the Hans Fischer (Senior) program.

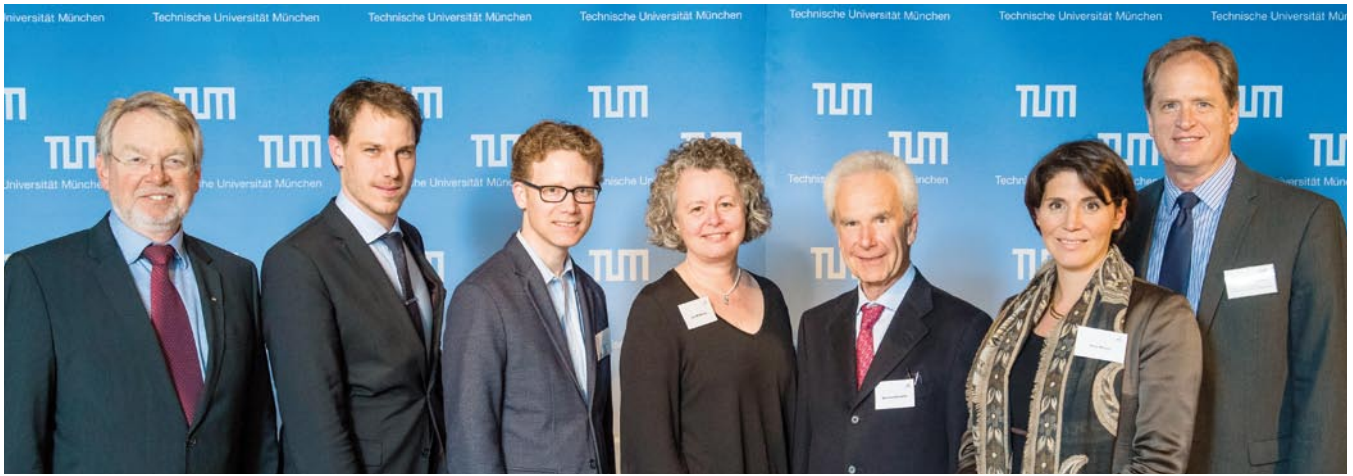

## Program

### **Extracting Molecular Function Patterns From Microbial Genomes and Metagenomes**

[Yana Bromberg](#) | Hans Fischer Fellow

### **Dynamic Supramolecular Materials**

[Job Boekhoven](#) | Rudolf Mößbauer Tenure Track Professor

### **Population Epigenetics and Epigenomics**

[Frank Johannes](#) | Rudolf Mößbauer Tenure Track Professor

### **The Coming of Age of Microfluidics: EDA Solutions for Enabling Biochemistry on a Chip**

[Tsung-Yi Ho](#) | Hans Fischer Fellow

### **EmaCure: Enhancing Vascularization Through Autologous Proteins**

[Arndt F. Schilling](#) | Clinic for Plastic Surgery and Hand Surgery, TUM

### **Millimeter-Wave Massive MIMO: M<sup>4</sup> for 5G**

[Lee Swindlehurst](#) | Hans Fischer Senior Fellow

### **Modeling the Earth's Gravity Field with Ultra-high Resolution**

[Christian Hirt](#) | Hans Fischer Fellow

### **Metropolis Nonformal: Contemporary Approaches Towards Mitigating and Anticipating Slums on a Planetary Scale**

[Christian Werthmann](#) | Alumnus Hans Fischer Senior Fellow

### **Novel Algorithms for 3-D Computer Vision**

[Daniel Cremers](#) | Gottfried Wilhelm Leibniz Prize Winner 2016

### **Mathematics for Data-Driven Modeling – The Science of Crystal Balls**

[Yannis Kevrekidis](#) | Hans Fischer Senior Fellow

### **Gendered Innovations in Science and Technology**

[Londa Schiebinger \(Stanford University\)](#) | TUM Distinguished Affiliated Professor and Member of the TUM-IAS Board of Trustees

### **Closing Remarks**

[Ernst Rank](#) | TUM-IAS Director





## International Symposium on Effective Field Theories and Lattice Gauge Theory

May 18–21, 2016

Organization: Focus Group Physics with Effective Field Theories

The central objective of the TUM-IAS Focus Group on Physics with Effective Field Theories is to explore new ways of exploiting this set of techniques, especially in concert with lattice gauge theory. For the non-expert, let us note that effective field theories disentangle physics at different length scales, so that the best theoretical tool can be used at each scale; when the dynamics are strongly coupled, lattice gauge theory provides a powerful computational tool. With this concept in mind, the Focus Group brought together practitioners in lattice gauge theory with experts in effective field theories. Over three-and-a-half days in May 2016, participants explored how effective field theories can broaden the range of application of numerical simulations and, conversely, how lattice gauge theory results can enhance the predictive power of effective field theories.

The talks covered many scientific topics in particle physics and nuclear physics. For example: How can we pin down the basic parameters of quantum chromodynamics (QCD, the modern theory of the strong nuclear force)? How does QCD behave when heated through a phase transition? How can we learn more about CP (charge conjugation and parity) violation from quarks and from neutrinos under the influence of the strong interactions? How does QCD influence axions, which are a candidate source of dark matter? Can lattice methodology be used to solve the riddle of quantum gravity? In most cases, a set of talks would be followed by an invigorating roundtable discussion.

In addition to the exploration of these topics, the symposium also offered an interesting talk on coarse-graining (i.e., scale separation) in engineering, and another two talks on optical lattices, namely macroscopic physical systems with the same kinds of symmetry as those governing the interactions of elementary particles. Serendipitously, conversations between the speakers presenting the latter two topics and a symposium participant helped inspire an innovative paper [1]. While the group could not have predicted this specific outcome, such an outcome was one of the aims.

On the afternoon of May 21, several participants enjoyed a tour of the optical-lattice laboratories at the Max Planck Institute of Quantum Optics, located at the Garching research campus, and later a stroll through Garching's historic Mühlentpark – Mill Park – followed by a pleasant evening at a local Biergarten.

[1] J. Unmuth-Yockey, J. Zhang, P. M. Preiss, L.-P. Yang, S.-W. Tsai, and Y. Meurice, "Probing the conformal Calabrese-Cardy scaling with cold atoms," 2016.



1 | Round table discussion “Field theory at finite temperature: alliance of effective field theories and lattice methods” chaired by Nora Brambilla (standing left). Panel members from left to right: Harvey Meyer, Peter Petreczky, Alexander Rothkopf, Antonio Vairo and Joan Soto.

*The full program (including slides) of the event is available at: [www.ias.tum.de/events/eftlgt2016](http://www.ias.tum.de/events/eftlgt2016).*

## International Symposium on Thermoacoustic Instabilities in Gas Turbines and Rocket Engines: Industry meets Academia

May 30–June 2, 2016

Organization: Focus Group Advanced Stability Analysis

Midway through 2016, the TUM-IAS hosted a four-day symposium on advances in thermoacoustic oscillations in gas turbines and rocket engines combustors. The event was organized and hosted by Thomas Sattelmayer, a professor of Thermodynamics at TUM, together with Bruno Schuermans, a TUM-IAS Rudolf Diesel Industry Fellow with General Electric Power.

### Motivation & Objectives

In both the design and operation of gas turbine combustors and rocket engines, it is of crucial importance to understand both the cause of thermoacoustic instabilities – and how to prevent them. And despite the apparent methodological and phenomenological overlaps between gas turbine and rocket engine technologies, two almost entirely separate research networks have evolved around both industries. And in turn, both industries have developed their own research strategies and methodologies. Currently, the strong overlap is further increasing due to recent growing interest in the issue of acoustically non-compact, high-frequency oscillations within the gas turbine community. The aim of this symposium was to bring together researchers from industry and academia and to provide a forum in which synergies between rocket and gas turbine research can be exploited.

### Scientific Framework

The symposium sought to provide a novel and unique form of scientific meeting for participants and speakers alike. To serve this purpose, the core of the symposium was built around nine “classical” sessions featuring the presentation of scientific papers on different topics related to thermoacoustic oscillations in gas turbine and rocket engines. Additionally, the best papers from the symposium were selected through a peer review process for publication in a special issue of the “International Journal of Spray and Combustion Dynamics.”

### Impact & Outcomes

The symposium connected academic institutions and industrial companies together with research communities and researchers working in the area of gas turbine and rocket engine thermoacoustics. It provided an excellent forum in which experts could identify overlapping research areas and initiate collaborations. Nine sessions covered a range of topics, from physical mechanisms and analysis approaches to system optimization. The symposium’s format – inviting nine keynote talks by experts – was enthusiastically received by all participants.



1 | A diverse and international group of experts attended the symposium during the summer of 2016.

In total, 54 papers were submitted and presented within 22 sessions. Moreover, the symposium boasted a very international mix: More than 100 participants and authors travelled to Munich to attend the four-day event from a diverse list of countries: the U.S., the U.K., Canada, Japan, Iran, South Korea, Australia, Switzerland, France, India, China, Italy and Germany.

The symposium community also got the opportunity to select the best scientific and technical papers presented over the course of the event. Authors of the winning papers were from ETH Zürich and Technische Universität Berlin, Germany, and each received a small monetary prize.

To complement the full days of scientific talks and conversation, the symposium fostered an atmosphere in which experts could engage in a productive dialogue, network with fellow researchers and discuss ideas for future collaborations and new projects. The positive resonance from both speakers and attendees will ideally lead to this symposium becoming a recurring event in the future.



2 | Best Paper Award Recipients. From left to right: Thomas Sattelmayer, Nicolas Noiray (ETH Zürich), Jonas Moeck (TU Berlin), Oliver Paschereit (TU Berlin), Dominik Wassmer (TU Berlin), Bruno Schuermans.

Each session kicked off with a talk by a leading expert from industry or academia. These experts were invited to share their views and visions on thermoacoustic instability research and the science behind the technology, which enriched not only the overall scientific quality of the symposium, but also made a key contribution to driving the dialogue between speakers and participants and academia and industry.

- [Raman I. Sujith](#) | Alumnus Hans Fischer Senior Fellow, Indian Institute of Technology in Madras, India
- [Sebastien Ducruix](#) Centre National de la Recherche Scientifique, France
- [Mirko Bothien](#) Ansaldo Energia, Switzerland
- [Kwanwoo Kim](#) General Electric, United States
- [Oliver Paschereit](#) Technische Universität Berlin, Germany
- [Oliver Knab](#) Airbus Defence & Space, Germany
- [Michael Oswald](#) Deutsches Zentrum für Luft-und Raumfahrt, Germany
- [Bill Anderson](#) Purdue University, United States
- [Laurent Selle](#) Institut de Mécanique des Fluides de Toulouse, France

## International Symposium on Networked Cyber-Physical Systems (Net-CPS)

September 19–20, 2016

Organization: Focus Group Networked Cyber-Physical Systems

Cyber-physical systems (CPS) are technological systems in which physical components and cyber components are tightly integrated. CPS have become ubiquitous. Inexpensive-yet-powerful devices can communicate, sense and act in their environment; intelligent interfaces allow for a more “natural” and rewarding interaction between humans and machines; and the global communication and computing infrastructure is expanding its reach and increasing its power by the minute. This new environment is often referred to as a network-immersed world to emphasize that humans are now an integral part of the overall system. Networked CPS (Net-CPS) emphasize that while in CPS, a key challenge is the modeling, performance evaluation and design of the tight integration of cyber and physical components, additional critical challenges emerge when such CPS operate in a networked setting. The challenges begin with trying to define and model what is actually meant by the abstraction of the term “network” in these scenarios. Myriad examples of networks abound, including: interconnected and interacting sociotechnical systems; social networks over the Internet; heterogeneous energy systems; connected cars and smart transportation environments; collaborating robots, or collaborating robots and humans, just to name a short sample of diverse network types. Humans are an important component of such systems. This is a critical and emerging area which has not yet received adequate attention by the research and development community.

Leading scientists in the areas of control, communication and computer science gathered for the International Symposium on Networked Cyber-Physical Systems (Net-CPS) at the TUM-IAS in September 2016 to discuss the research challenges in this emerging and critical area. Internationally renowned experts shared their views within the symposium’s three plenary lectures, 12 invited lectures, two panel and two poster sessions. More than 90 researchers from Germany and abroad participated in the event.

Important points of discussion included:

- 1 **Networked CPS have very wide and diverse application domains.** The transportation, energy and manufacturing sectors are currently the domains in which networked CPS is gaining in influence.
- 2 **The scale and complexity of networked CPS grows continuously as inexpensive communication, computation and sensing becomes ever more available.** Analysis and design methods have to measure up in scalability. The effect of a given network and of a network in all its different activities and roles – be it the interaction, information sharing, or communication network – needs to be better understood.



### 3 Due to the complexity, multi-physics, multi-time scale, and distributed nature of networked CPS, modeling poses a significant research challenge.

Furthermore, the sources and, therefore, the quality of models might be heterogeneous – an aspect that needs to be considered in analysis and design. The combination of model-based and data-based designs might be one of the promising routes towards solving this issue. The run-time calibration of models using data and run-time certification are further topics of high relevance.

4 In addition to performance, safety, security resilience and privacy all constitute important design aspects. Reconciling performance with security can often lead to contradictory design specifications, for example between performance and privacy, for which suitable trade-offs need to be determined. Architectural principles for networked CPS are another open research challenge.

### 5 Humans play a significant role in networked CPS.

Human interaction with a networked CPS occurs through interfaces, which requires these interfaces to

to be efficient and intuitive to use, e.g., user friendly. Given the increasing autonomy of networked CPS, it is important to determine when human intervention is needed and/or desired. Humans further determine the quality metrics in many networked CPS application domains, for example in transportation and energy systems. Understanding human decision making, human-system interaction/cooperation and human quality metrics is of vital importance. Additionally, understanding the legal and ethical issues arising with increasing network autonomy need to be considered, e.g. legal or financial responsibility or culpability in the case that a network fails.

6 Education will need to be adapted to address the new challenges raised by networked CPS and the key role played by humans. Emphasis on modeling and validation methods and tools should be incorporated in both undergraduate and graduate classes, as well as in the teaching of analytical methods combining calculus and logic mathematics. It is also extremely important to develop coursework providing hands-on projects that allow students access to work with realistic networked CPS and human elements.

## Collaborative Workshop on Biomedical Imaging

November 9–11, 2016

Organization: TUM, TUM-IAS and the Institute of Advanced Studies, Nanyang Technological University, Singapore



The TUM-IAS welcomed experts from Singapore's Nanyang Technological University (NTU) to Munich for a three-day focus on challenges and issues in biomedical imaging. The Collaborative Workshop on Biomedical Imaging was jointly organized by TUM-IAS and NTU, and covered topics in the areas of clinical applications and research – from dynamic imaging in diagnostics to a discussion on medical and bioengineering issues.

TUM and NTU enjoy a longstanding strategic partnership. The activities between these renowned universities range from a very active student exchange to joint master programs under the auspices of TUM's presence in Asia, TUMAsia, as well as numerous bilateral research collaborations in a wide range of scientific fields. With the recent creation of the TUM School of Bioengineering and the Interdisciplinary Center for Cancer Research (TranslaTUM), the joint workshop on biomedical imaging was organized to explore the potential for collaboration within this field. The workshop focused specifically on the following themes: BMI in Material Science; novel X-ray imaging technologies; optical acoustics; translation of BMI in clinical radiology; MR-Imaging with hyperpolarized nuclei; radioisotopes for imaging; transmission electron microscopy; molecular imaging in immunology and image based modeling.

The goal of the event, which was attended by around 30 experts, was to foster an exchange between the two universities to identify common areas of interest and complementary expertise. Representatives from each respective institution had the chance to learn more about their counterparts' work in the area of biomedical imaging. Of particular interest for experts at TUM was getting to take a closer look at the activities at NTU in the field of biomedical photonics, with a specific focus on super-resolution microscopy for live cell dynamics investigations. Two days of in-depth presentations by NTU and TUM experts were rounded out by a full day of on-site lab tours on the last day of the workshop. The tour started with a visit to the TUM Institute for Medical Engineering (IMETUM), located at the TUM Garching campus. It was followed by a transfer to downtown Munich and a guided tour of the TUM Institute for Translational Cancer Research (TranslaTUM) and the TUM Institute of Molecular Immunology and Experimental Oncology at the University Hospital Klinikum rechts der Isar.





1 | Experts from TUM, TUM-IAS and NTU met in Munich for the Collaborative Workshop on Biomedical Imaging in November 2016.

## ESO/TUM-IAS Masterclass in Ethical Counseling in Oncology and Gender Issues

November 23–24, 2016

Organization: Focus Group Biomedical Humanities



Together with the European School of Oncology (ESO), which provided financial support, the TUM-IAS presented the Masterclass in Ethical Counseling in Oncology and Gender Issues.

The two-day conference in November 2016 tackled issues pertaining to the ethical controversies and difficult decisions facing researchers, clinicians, patients and caregivers in the day-to-day operation of a hospital oncology department – and the diagnosis and treatment of cancer patients. Frequently, these issues become entangled in moral values, religious beliefs, legal constraints, professional duties and medical guidelines, which add layers of complexity to biomedical decision-making. Moreover, many of the decisions made in relation to a patient’s diagnosis and care can be strongly influenced by gender issues. As a consequence, decision-makers often find themselves stuck in a sort of “ethical-decisional paralysis.” It is a situation which spurs the necessity for ethical counselors and counseling services – not only to support the ethical decision-making of both patients and physicians, but to do so without weakening the autonomy of the former or relieving the responsibility of the latter. The Masterclass in Ethical Counseling in Oncology and Gender Issues was chaired by Mariacarla Gadebusch Bondio (Institute for History and Ethics of Medicine, TUM) and Giovanni Boniolo (Dipartimento di Scienze Biomediche e Chirurgico Specialistiche of the Università di Ferrara & TUM-IAS).

The Scientific Board included Marion Kiechle (Gynecological Clinic, TUM), Fedro A. Peccatori (ESO) and a very internationally renowned faculty: Marco Annoni (National Research Council, CNR, Rome); Luigi Grassi (Dipartimento di Scienze Biomediche e Chirurgico Specialistiche, Università di Ferrara); Ingo F. Herrmann (Reflux Center Düsseldorf); Peter Herschbach, (Psychosocial Oncology, TUM); David Teira, (Departamento de Lógica, Historia Filosofía de la Ciencia, UNED Madrid); Lea Baider (Hadassh Medical School, Oncology Institute, Jerusalem). The masterclass was well visited with 30 registered participants from European and international organizations, and included the participation of ten TUM faculty members.

The overall goal of the masterclass was to equip participants with a set of philosophical and ethical tools – skills and ideas that would allow them to positively cope with decisions related to their day-to-day work with cancer patients and their families. A particularly strong focus was placed on improving ethical skill sets for medical specialists, and providing oncologists and specialists in other areas of medicine with a philosophy-based methodology from which to approach controversial clinical cases by using real-life examples involving gender issues.

## Liesel Beckmann Symposium: Ethical Counseling in the Age of Personalized Medicine and Diversity Issues

November 25, 2016

Organization: Focus Group Biomedical Humanities

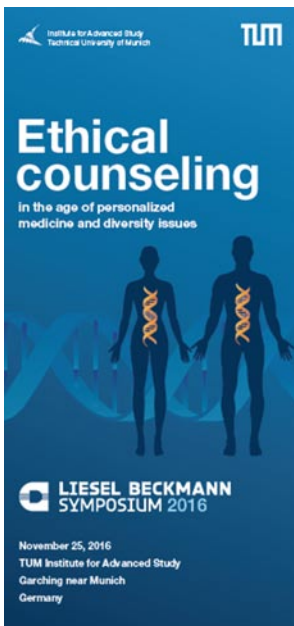

In late November 2016, the TUM-IAS hosted the annual Liesel Beckmann Symposium, this time with a focus on ethics in medicine: Ethical Counseling in the Age of Personalized Medicine and Diversity Issues.

The aim of the one-day conference was to investigate how the need for services providing ethical decision-making support has grown in the age of globalization and personalized medicine. Starting with the premise that ethical controversies and difficult ethical decisions in the daily activities of a hospital are strongly influenced by gender issues, cultural differences, moral values and religious beliefs, participants focused on how the quality of these ethical decisions can be increased.

The conference was chaired by Mariacarla Gadebusch Bondio (Institute for History and Ethics of Medicine, TUM), and Giovanni Boniolo (Dipartimento di Scienze Biomediche e Chirurgico Specialistiche, Università di Ferrara & TUM-IAS).

Chiara Mannelli (Università di Torino) served as scientific coordinator.

The speakers, who came from several European countries and from abroad, approached the topic from three different perspectives: ethical counseling, diversity and personalized medicine. Giovanni Boniolo opened the conference with a talk on ethical counseling and diversity. Mark Sheehan (Ethox Centre Oxford) focused on the relationship between ethical counseling and authority; Marta Spranzi (Université de Versailles St-Quentin-en-Yvelines) discussed the impact of culture and religion in clinical ethics consultation. Maya Sabatello (Columbia University, New York), Silke Schicktanz (Georg-August-Universität Göttingen), Ruth Chadwick (Cardiff University) and Mariacarla Gadebusch-Bondio (TUM) emphasized how personalized medicine in its different forms can generate ethical questions and conflicts. Even though an airline strike prevented Ruth Chadwick from participating in person, she was able to join via Skype.

## The TUM-IAS “Neighbors in Garching” Lecture Series: So what exactly is it that you do in Garching?

A peek behind the scenes at the work being done  
by researchers in Garching



Several times a year, the TUM-IAS opens its doors to interested neighbors from the region for a regular “science Sunday matinee” throughout the year.

The TUM-IAS “Neighbors” series was an immediate hit when it debuted back in 2013. Former Institute director, Prof. Gerhard Abstreiter, came up with the concept as a way to answer the question he was always getting from area locals: “So what exactly is it that you do at the Garching campus?” He envisioned the series as a way to get the local community and neighbors living around TUM’s Garching campus more involved in the fascinating research going on right next door to them – and start a true dialog with our neighbors. In the meantime, many “Neighbors” regulars to the talks say the Sunday science presentations have become a favorite part of their weekend.

Around three to five times each year, TUM-IAS welcomes the public in on a Sunday morning for a mix of cutting-edge science and more traditional, German-style “coffee and Brez'n” Sunday morning atmosphere. We feature an informal talk by a well-known scientist – either an expert from the university, or from one of our campus neighbors like the Max Planck Institute of Plasma Physics or Leibniz Supercomputing Center. The challenge for our scientists? To make their work accessible and exciting for the diverse, general-public audiences in attendance, and to ensure that even the non-scientists in the crowd get a good understanding of the oftentimes complex scientific research.

On average, the talks draw a respectable crowd of around 80 – with a diverse mix of people from nearby communities ranging in age from grade school to retirement age. In around 45–60 minutes, TUM and Garching campus scientific experts, professors and researchers take their audiences on a scientific journey to give them a peek into a world of fascinating research and scientific breakthroughs. Topics cover a wide spectrum of topics and answer questions such as: “Why does anyone need a super computer?” or “What exactly is a black hole?” and “What’s the coldest object in the Universe?” Following the talks, audience members get the opportunity to ask follow-up questions and talk directly with the experts over a cup of coffee and fresh-baked pastries.



- April 10      Lecture Series Neighbors in Garching  
**Pedestrian Simulation Reaching the Destination, Step by Step.**  
 Organization: TUM-IAS  
 Speaker: [Prof. André Borrmann](#) (Computational Modeling and Simulation, TUM)
- July 17        Lecture Series Neighbors in Garching  
**Climate Change – The Interaction between the Atmosphere and Life on Earth**  
 Organization: TUM-IAS  
 Speaker: [Prof. Fritz E. Kühn](#) (Molecular Catalysis, TUM)
- October 30    Lecture Series Neighbors in Garching  
**Using DNA to Build Molecular “Machines”**  
 Organization: TUM-IAS  
 Speaker: [Prof. Hendrik Dietz](#) | Carl von Linde Senior Fellow

## Fellows' Lunches

Typically once a month, the TUM-IAS invites its Fellows, Honorary Fellows, Host professors and other community members to lunch for an afternoon of food and exchange of ideas. This tradition has, in the meantime, become a favorite of ours for two main reasons: First, it provides a great opportunity to hear more about the fascinating work our members are currently focused on. Over the course of 2016, for example, Fellows' lunchtime talks covered as diverse a range of topics as material and environmental sciences, modeling human skill, genomics and computational mechanics as well as particle physics. It's the discussion after the informal presentation, though, that is usually just as interesting! The lunchtime presenter gets the chance to explain his or her work to a range of scientists and experts working in oftentimes very different disciplines – and with very different backgrounds.

Secondly, and just as important, the main purpose of the Fellows' Lunches is to bring our community together – to provide a space where we can all gather on a regular basis and encourage the free flow of ideas and interaction. These lunches truly embody what the TUM-IAS is all about – we're always amazed and inspired by watching a group of scientists from a disparate mix of backgrounds and disciplines coalesce and then form new and unexpected bonds. Whether it's identifying common research interests with colleagues from different areas or hitting upon all new ideas, the Fellows' Lunches truly do offer food for thought.

- |            |  |
|------------|--|
| February 1 | <p><b>Bio-inspired Strategies for Materials Sciences</b><br/> <a href="#">Prof. Job Boekhoven</a>   Rudolf Mößbauer Tenure Track Professor</p>   |
| March 7    | <p><b>Novel Measurements with an Environmental Impact:<br/>Lead in Bones, CO2 Fluxes in Forests, Methane in the Neighborhood</b><br/> <a href="#">Prof. Steven C. Wofsy (Atmospheric and Environmental Science, Harvard University)</a>   August-Wilhelm Scheer Visiting Professor</p> |
| May 23     | <p><b>Modeling and Measuring Human Skill</b><br/> <a href="#">Prof. Gregory D. Hager</a>   Hans Fischer Senior Fellow</p>  |
| July 14    | <p><b>Prediction of Genetic Value of Animals and Plants Using Massive Genomic data</b><br/> <a href="#">Prof. Daniel Gianola</a>   Alumnus Hans Fischer Senior Fellow</p>  |
| October 6  | <p><b>Advanced Numerical Simulation via Isogeometric Analysis: Towards New Frontiers for Computational Mechanics</b><br/> <a href="#">Prof. Alessandro Reali</a>   Hans Fischer Senior Fellow</p>  |
| November 7 | <p><b>When Beauty (of Elementary Particles) Decays</b><br/> <a href="#">Dr. Andreas Kronfeld</a>   Hans Fischer Senior Fellow</p>  |



Launched in 2013 as an informal exchange of ideas for the TUM-IAS community, the Wednesday Coffee Talks have, in the meantime, become a veritable institution at the university – one of the most popular and well-known weekly “rituals” at TUM. The brainchild of former Institute director, Gerhard Abstreiter, the coffee talks take place in the spacious “chillax” atrium lounge on the 1st floor of the TUM-IAS, and fill the gap between formal science presentation and relaxed coffee break. Whether student, staff or academic faculty member, everyone working at TUM has a standing invitation to join the TUM-IAS family on Wednesdays. The talks start with coffee and seasonal sweets, then visitors get to sit back on the inviting, bright orange modular sofas filling the atrium to hear about some of the most important and interesting research work currently being done in a broad variety of disciplines. In 2016, “Coffee Talk” topics ran the gamut from X-ray technology through to tackling water quality issues and solving mysteries of the Universe to using algorithms to predict which “Game of Thrones” character would perish next in the popular television series.

On most Wednesdays, the TUM-IAS “living room” fills up quickly with a motley crew of students, Fellows, visiting professors, heads of department, university staff and other guests in anticipation of what some call their “weekly free tutorial.” The Wednesday Coffee Talks perfectly embody the spirit of the TUM-IAS, in that they bring people together from a disparate mix of backgrounds and disciplines – which almost always makes for exciting presentations followed by lively conversation, new discoveries and fertile ground for future collaboration.

- January 13 [Dr. Kaye Morgan](#) on the world’s first mini particle accelerator for high-brilliance X-rays at TUM (MuCLS)
- January 20 [Prof. Markus Disse](#) on sustainable oasis management in China’s largest cotton-growing region
- January 27 [Prof. Thomas Letzel](#) on developing a worldwide screening system for preventative water sample analysis (FOR-IDENT)
- February 3 [Dr. Kai Müller](#) on dynamics of semiconductor quantum bits (qubits)
- February 10 [Prof. Horst Kessler](#) on the development of ligands addressing subtypes of cell adhesion receptors (integrins) selectively
- April 6 [Dr. Tamara Zietek](#) on organoids exhibiting essential functions of a real intestine
- April 13 [Prof. Peter Müller-Buschbaum](#) on optimized printing processes enabling custom organic electronics
- April 20 [Dr.-Ing. Daniel Renjewski](#) on developing the robot ATRIAS whose gait comes closer than ever before to that of humans

- April 27 [Prof. Thomas F. Fässler](#) on new approaches for hybrid solar cells
- May 4 [Prof. Nikolaus A. Adams](#) on numerical modeling of shock-interface interactions and the resulting challenges for HPC systems
- May 11 [Prof. Ingrid Kögel-Knabner](#) on humus depletion as a possible result of climate change
- May 25 [Prof. Anca Muscholl](#) on automated synthesis of controllers for distributed programs
- June 1 [Dr. Alexander Groh](#) on the “high-order” thalamus and its elucidated role in processing sensory perceptions
- June 8 [Prof. J. Leo van Hemmen](#) on internally coupled ears enabling directional hearing in animals
- June 15 [Prof. Heiko Briesen](#) on the interaction of chocolate ingredients at the molecular level
- June 22 [Prof. em. Erwin A. Schubert](#) on the interplay of magnetism, nuclear spin, and nonclassical superconductivity
- June 29 [Prof. Fritz Busch](#) on developing smart assistance systems for urban driving and the role of pedestrian simulators
- July 6 [Tatyana Goldberg](#) on computer algorithms predicting next characters to be eliminated in “Game of Thrones”
- July 13 [Prof. Ulrich Heiz](#) on sub-nanometer catalysts and the elucidated role of particle shape and size regarding hydrogenation reactions
- October 19 [Prof. Thomas A. Wunderlich](#) on a new measurement method enabling precise orientation on shaft floors which was developed in the context of the work in the Gotthard Base Tunnel in Switzerland
- October 26 [Prof. Elisa Resconi](#) on the origin of the highest energetic cosmic particles ever observed, a 100 years old puzzle
- November 2 [Dr. Eva M. Herzig](#) on time-resolved measurements on structural evolution in printed solar cells and possibilities for structural control at the nanoscale
- November 9 [Prof. Willi Auwärter](#) on hybrid material opening the door to new possibilities in graphene applications
- November 16 [Prof. Andreas Bausch](#) on colloidal structure formation by kinetic arrest
- November 23 [Prof. Tom Nilges](#) on a double-helix structure discovered in an inorganic material
- November 30 [Dr. habil. Thomas Clavel](#) on a new bioinformatics tool for searching bacterial sequencing data
- December 14 [Dr.-Ing. Georg Böcherer](#) on a novel modulation approach fostering higher transmission capacity
- December 21 [Dr. Markus Heyl](#) on a new protocol to detect entanglement of many-particle quantum states using established measuring methods



## Events 2016

- January 18–20 Symposium **Selected Topics in Science and Technology** (in the framework of the selection process regarding the Rudolf Mößbauer Tenure Track Professorships) Organization: TUM-IAS 39
- January 20 TUM Water Cluster Lecture Series **At the Confluence: Nutrients, Trace Chemicals, and Sustainability in the Urban Water Sector**  
Speaker: [Prof. Nancy Love](#) (University of Michigan)  
Organization: TUM Water Cluster, IGSSE, TUM-IAS
- January 26 Inaugural Lecture **Integrative Dynamical Biology: How to Model and What We Learn from Protein Dynamics**  
Speaker: [Prof. Carlo Camilloni](#) | Rudolf Mößbauer Tenure Track Professor
- January 28 Talk **Optimal Control of Spin Systems with Applications in Magnetic Resonance Imaging**  
Speaker: [Prof. Dominique Sugny](#) | Hans Fischer Fellow
- February 5 Symposium **Micro-Nano Mechatronics/Robotics**  
Organization: [Prof. Martin Buss](#) | Carl von Linde Senior Fellow
- February 19 Speaker Series on New Frontiers in Battery Science and Technology **From Metastable Oxides to Battery Materials – Perspectives from a Solid State Chemist**  
Speaker: [Dr. Dominik Weber](#) (Justus-Liebig-University Gießen)  
Organization: [Dr. Peter Lamp](#) | Rudolf Diesel Industry Fellow
- March 9–11 20th International ITG Workshop on **Smart Antennas**  
Organization: Chair for Circuit Theory and Signal Processing, TUM  
Speaker: [Prof. A. Lee Swindlehurst](#) | Hans Fischer Senior Fellow et al.
- March 14–15 Munich Battery Discussions **Electrode-Electrolyte Interface (EEI) – from Fundamentals to Cell Manufacturing**  
Organization: [Dr. Peter Lamp](#) | Rudolf Diesel Industry Fellow,  
[Prof. Hubert Gasteiger](#) (Technical Electrochemistry, TUM)
- March 14–18 Workshop on **Isogeometric Finite Element Data Structures based on Bézier Extraction**  
Organization: Chair for Computation in Engineering, TUM  
Speaker: [Prof. Alessandro Reali](#) | Hans Fischer Fellow et al.
- March 24 Speaker Series on New Frontiers in Battery Science and Technology **Probing Active/Functional Sites in Perovskites and 2D Materials with Advanced Electron Microscopy Techniques**  
Speaker: [Prof. Vaso Tileli](#) (École Polytechnique Fédérale de Lausanne)  
Organization: [Dr. Peter Lamp](#) | Rudolf Diesel Industry Fellow
- April 25 Inaugural Lecture **High-Resolution Insights into Amyloid Cell Toxicity**  
Speaker: [Prof. Ayyalusamy Ramamoorthy](#) | Hans Fischer Senior Fellow

April 27 TUM Water Cluster Lecture Series **Floods in a Changing World**

Speaker: [Prof. Günter Blöschl](#) (TU Wien)

Organization: TUM Water Cluster, IGSSE, TUM-IAS

April 28–29 **TUM-IAS General Assembly**

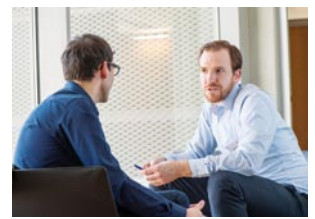

May 18–21

Symposium **Effective Field Theories and Lattice Gauge Theory**

Organization: [Dr. Andreas Kronfeld](#) | Hans Fischer Senior Fellow,  
[Prof. Nora Brambilla](#) (Particle Physics and Nuclear Physics, TUM)



May 19 Workshop **Ethical Counselling in the Age of Personalized Medicine and Multicultural Diversity**

Organization: [Prof. Giovanni Boniolo](#) | Anna Boyksen Fellow,  
[Prof. Mariacarla Gadebusch Bondio](#) (Institute for History and Ethics of Medicine, TUM)

May 25 TUM Water Cluster Lecture Series **Advanced Wastewater Treatment Systems and Upgrade to High Quality Process Water for Reuse Purposes**

Speaker: [Dipl.-Ing. Heribert Möslang](#) (Aquantis GmbH)

Organization: TUM Water Cluster, IGSSE, TUM-IAS

May 30–June 2

International Symposium **Thermoacoustic Instabilities in Gas Turbines and Rocket Engines: Industry meets Academia**

Organization: [Dr. Bruno Schuermans](#) | Rudolf Diesel Industry Fellow,  
[Prof. Thomas Sattelmayer](#) (Thermodynamics, TUM)



May 31 Inaugural Lecture **Biologically Inspired Supramolecular Materials**

Speaker: [Prof. Job Boekhoven](#) | Rudolf Mößbauer Tenure Track Professor

June 20 Talk **Towards a Rigorous Framework for MBSE and Applications**

Speaker: [Prof. John Baras](#) | Hans Fischer Senior Fellow

June 20–21 Workshop **Hybrid Simulation Methods in Fluid Dynamics: Models, Software and Applications**  
 Organization: [Prof. George Biros](#) | Hans Fischer Fellow,  
[Dr. Philipp Neumann](#) (Scientific Computing, TUM)

June 29 **TUM-IAS Summer Faculty Day**

July 6 TUM Water Cluster Lecture Series **Workshop: Research Strategies for Resilient Water Systems**  
 Organization: TUM Water Cluster, IGSSE, TUM-IAS

July 14 Kick-off Symposium **Sterile Neutrinos and Dark Matter**  
 Organization: [Dr. Thierry Lasserre](#) | Hans Fischer Senior Fellow

July 14 Talk **Expanding the Genetic Code – Chemistry in Living Systems**  
 Speaker: [Prof. Kathrin Lang](#) | Rudolf Mößbauer Tenure Track Professor

September 19–20



International Symposium **Networked Cyber-Physical Systems (NET-CPS 2016)**  
 Organization: [Prof. John Baras](#) | Hans Fischer Senior Fellow,  
[Prof. Sandra Hirche](#) (Information-oriented Control, TUM)

September 20

International Symposium **Clinical Cell and Tissue Engineering (TUM-IAS Focal Period 2016)**  
 Organization: [Prof. Dirk H. Busch](#) (Institute for Medical Microbiology, Immunology and Hygiene, TUM),  
[Prof. Dietmar W. Hutmacher](#) | Alumnus Hans Fischer Senior Fellow

September 30

Speaker Series on New Frontiers in Battery Science and Technology  
**Evaluation of Lithium Thiophosphates for the Application as Solid Electrolytes in All-Solid-State Batteries**  
 Speaker: [Dr. Stefan J. Sedlmaier](#) (Karlsruhe Institute of Technology)  
 Organization: [Dr. Peter Lamp](#) | Rudolf Diesel Industry Fellow

October 7

Speaker Series on New Frontiers in Battery Science and Technology  
**Unprecedented Heterostructured Cathode Materials for Advanced Li-ion Batteries: Multiphase Lithium Deficient  $\text{Li}_x(\text{Ni}_{1/3}\text{Mn}_{1/3}\text{Co}_{1/3})\text{O}_2$  ( $x < 1.0$ )**  
 Speaker: [Prof. Sung-Jin Cho](#) (North Carolina A&T State University)  
 Organization: [Dr. Peter Lamp](#) | Rudolf Diesel Industry Fellow

October 12–14

Conference **Conditional Independence Structures and Extremes**  
 Organization: [Prof. Claudia Klüppelberg](#) | Alumnus Carl von Linde Senior Fellow,  
 Prof. Steffen L. Lauritzen (University of Copenhagen)

October 19

TUM Water Cluster Lecture Series **From Science to Policy in the Water World – Work at the German Environment Agency**  
 Speaker: [Dr. Lilian Busse](#), German Environment Agency  
 Organization: TUM Water Cluster, IGSSE, TUM-IAS

- October 20 Symposium **Electrochemical Energy Conversion and Storage** in honor of Prof. Ulrich Stimming's 70th Birthday | *Alumnus Carl von Linde Senior Fellow*  
Organization: TUM Physics, Informatics and Chemistry Department, MSE, TUM-IAS
- October 22 Tag der offenen Tür  
Talk **Lebende Medikamente: Gabe von T-Zellen zur Therapie von Krebs und Infektionen**  
Speaker: [Prof. Dirk H. Busch](#) (Institut für Medizinische Mikrobiologie, Immunologie und Hygiene, TUM)  
Talk **Was hat Physik mit Krebsforschung zu tun?**  
Speaker: [Prof. em. Bernhard Schrefler](#) | *Hans Fischer Senior Fellow*
- October 28 Symposium **Flavor Physics** in honor of Prof. em. Andrzej Buras' 70th Birthday  
*Alumnus Carl von Linde Senior Fellow*  
Organization: [Prof. Martin Beneke](#) (Theoretical Elementary Particle Physics, TUM)
- November 2–4 Symposium **Land-Use/Transportation Modeling**  
Organization: [Prof. Rolf Moeckel](#) | *Rudolf Mößbauer Tenure Track Professor*
- November 9–11 TUM-IAS NTU-IAS Joint Workshop **Biomedical Imaging**  
Organization: [Prof. Franz Pfeiffer](#) | *Carl von Linde Senior Fellow*
- November 22 TUM Water Cluster Lecture Series **Seeing Things Differently: Rethinking the Relationship Between Data, Models, and Decision-Making**  
Speaker: [Prof. Ty Ferre](#) (University of Arizona)  
Organization: TUM Water Cluster, IGSSE, TUM-IAS
- November 23–24 ESO/TUM-IAS Masterclass **Ethical Counselling in Oncology and Gender Issues**  
Organization: [Prof. Giovanni Boniolo](#) | *Anna Boyksen Fellow*,  
[Prof. Mariacarla Gadebusch Bondio](#) (Institute for History and Ethics of Medicine, TUM)
- November 25 Liesel Beckmann Symposium **Ethical Counselling in the Age of Personalized Medicine and Diversity Issues**  
Organization: [Prof. Giovanni Boniolo](#) | *Anna Boyksen Fellow*,  
[Prof. Mariacarla Gadebusch Bondio](#) (Institute for History and Ethics of Medicine, TUM)
- November 28 Symposium **Experimental Semiconductor Physics** in honor of Prof. em. Gerhard Abstreiter's 70th Birthday (former TUM-IAS Director)  
Organization: [Prof. Jonathan Finley](#) (Semiconductor Quantum Nanosystems, TUM)
- December 14 **TUM-IAS Winter Faculty Day**





22

24

23

23

13

19

21

13

19

17

20



## In Focus

Clinical Cell and Tissue Engineering Focal Period

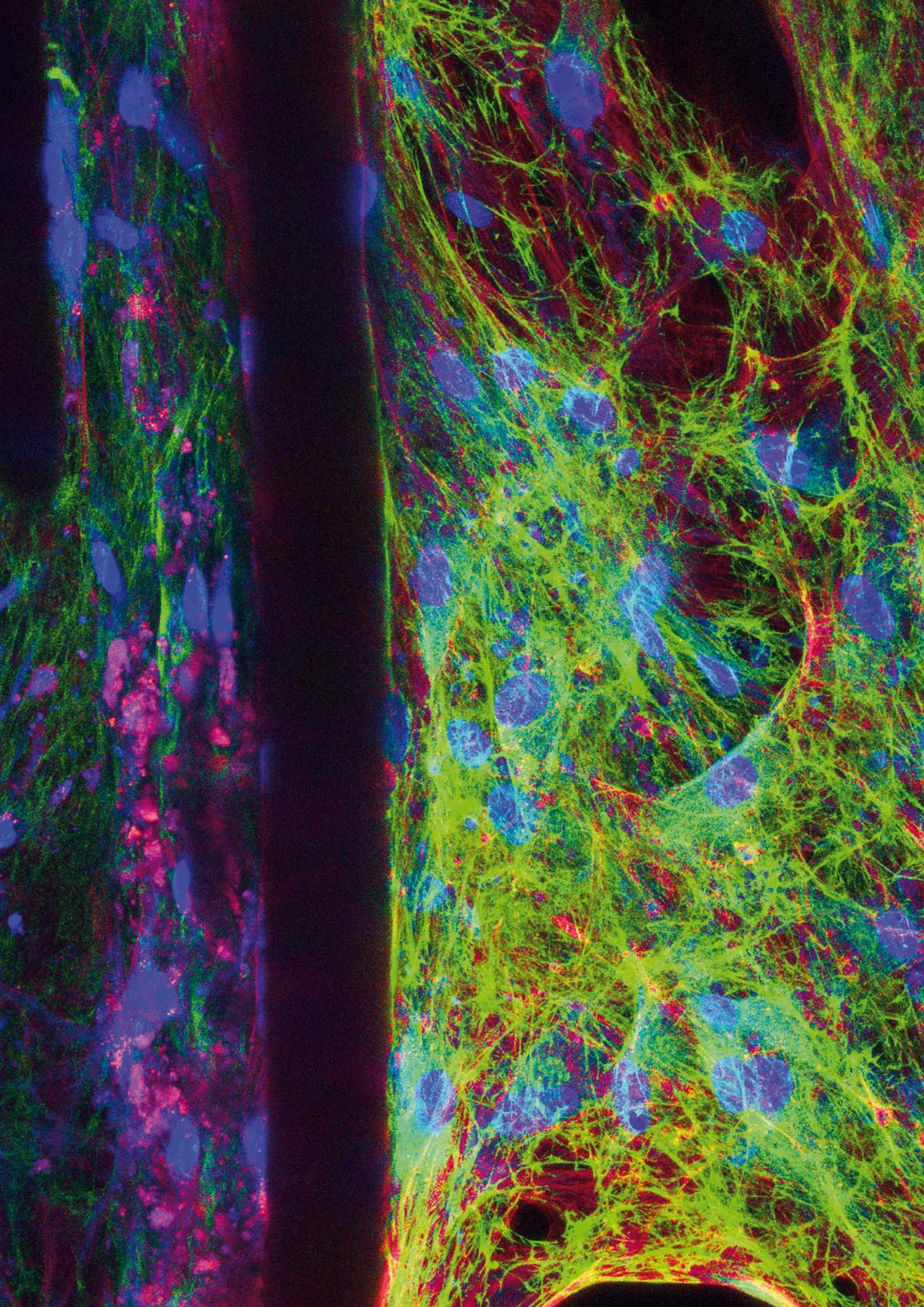



Excerpts from an interview on Nov. 28, 2016

Interviewer: *Erica Gingerich*  
Interviewed scientists: *Prof. Dirk Busch, Prof. Dietmar W. Hutmacher, and Prof. Stanley Riddell*

On the surface, medical therapies designed to treat diseased human tissue – cancer, for example – don't ostensibly have much in common with therapies designed to grow human tissue, such as the reconstruction of large bone defects. The TUM-IAS has brought together an interdisciplinary group of experts exploring how two different approaches to cell and tissue engineering – clinical cell purification, processing and therapy (CT) and tissue engineering and regenerative medicine (TE&RM) – might converge. In recent years, both CT and TE&RM have received increasing attention in the development of innovative and highly effective therapies for a growing range of illnesses and diseases.

Although coming from different research directions, leading experts from the TUM-IAS Clinical Cell Processing and Purification Focus Group and the Regenerative Medicine Focus Group have identified the synergies between their respective research areas, and collaborated for the TUM-IAS Clinical Cell and Tissue Engineering Focal Period for a workshop from September 20–22, 2016.

The major goal of the Focal Period group concept was to bring existing expertise at the TUM-IAS in TE&RM together with the TUM biomedical community in order to foster both fundamental and cutting-edge translational research in this rapidly emerging research field. With the establishment of its Graduate School of Bioengineering in 2015, TUM committed itself to strengthening its academic activities in this globally emerging research area. Biomedical engineering comprises one of the main pillars in this program, and TUM places a strong emphasis on translating technology developments into defined clinical applications.

## 48 TUM-IAS Cell Processing and Purification Focus Group (CT Focus Group)

Heading up the CT Focus Group, Hans Fischer Senior Fellow, Prof. Stanley (Stan) Riddell, is a professor with the Department of Medicine at the University of Washington (USA) and Director of the Immunotherapy Integrated Research Center at the Fred Hutchinson Cancer Research Center in Seattle (USA). His TUM host is Prof. Dirk H. Busch, the Chair of the Institute for Medical Microbiology, Immunology and Hygiene at the TUM School of Medicine. The CT Focus Group is working on the development of advanced and integrated cell processing platforms and the use of genetic modification of patient-derived immune cells to fight disease. In recent years, researchers have made major strides in the development of immunotherapies that utilize a highly purified and genetically engineered T cells to combat certain types of cancer and infections. Focus Group researchers have already successfully demonstrated that they can treat life-threatening infections, like cytomegalovirus, that occur in patients undergoing bone marrow transplantation. Furthermore, the first applications of this approach for cancers, like B cell leukemia or lymphoma, have been undertaken by introducing a tumor-specific receptor into a patient's own T cells, and demonstrated very promising results. In many patients treated with these genetically enhanced T cells that recognize and attack cancer cells, "the tumor literally melts away," according to Stan Riddell.

## TUM-IAS Regenerative Medicine Focus Group (RM Focus Group)

Hans Fischer Senior Fellow, Prof. Dietmar W. Hutmacher, is with the Chair in Regenerative Medicine and Director of the ARC Centre in Additive Biomanufacturing at the Institute of Health and Biomedical Innovation, Queensland University of Technology (Australia.) He shares leadership of the RM Focus Group together with Prof. Arndt F. Schilling, and Prof. Hans-Günther Machens, TUM Clinic for Plastic Surgery and Hand Surgery. The group's focus is tackling the lack of functional integration between tissue-engineered constructs (TECs) and surrounding host tissues, which poses a critical barrier that limits the effectiveness and clinical translation of current soft tissue interface graft technologies. The overarching goal of the RM Focus Group is addressing this challenge through the development of highly adaptable platform technologies in fields such as breast and lymph node tissue engineering, for example. Through this project, an international network spanning scientists, engineers, clinicians, industry and government will be established to accelerate the pace of regenerative medicine research that targets the reconstruction of complex soft tissue interface abnormalities and defects. The RM Focus Group also has the objective of developing a world-class TE&RM program that will be focused on additive tissue manufacturing (e.g. 3-D printing of tissue using human cells) for the regeneration of soft tissue interfaces, specifically for breast reconstruction.



Erica Gingerich, Dietmar W. Hutmacher, Stan Riddell and Dirk Busch

In an interview at the end of November 2016, *Erica Gingerich* (EG) with the TUM Corporate Communications Center and TUM-IAS science writer, caught up with *Dirk Busch* (DB) at his office in downtown Munich. He was joined by *Stan Riddell* (SR), who had just arrived from the U.S. to accept the accolade of TUM Ambassador from President *Wolfgang A. Herrmann*. *Dietmar W. Hutmacher* (DWH) stayed up into the early hours of the morning on the other side of the globe in Australia to join the conversation via Skype to talk about the Focal Period collaboration.

**EG:** Perhaps we could start with some background about your work together in each respective Focus Group – and about what convinced you to join forces for the Clinical Cell and Tissue Engineering Focal Period in September 2016.

**DB:** Looking at the CT Focus Group, my collaboration with Stan started with some very basic questions on how the immune system works, and subsequently, we asked how this knowledge could be used to develop targeted therapies for diseases such as cancer. The idea of using immune cells for therapy has been around for a long time – we consider this sort of therapy as having a “living drug” – unlike with a pill, chemotherapy or radiation, we use living lymphocytes, in our case, T cells. To make a long story short: What we’ve identified through our work together is that it matters what kind of T cell, what subtype, you use for a specific therapy.



Stan Riddell

Another topic we are working on is learning more about the characteristics a specific receptor has to have to offer the most effective targeted therapy. I think this field has seen dramatic developments in recent years. We nowadays have the ability to equip immune cells with receptors that can “see” only defined targets when introduced into the human body, for example, a cancer cell or an infected cell.

**SR:** At the beginning of the CT Focus Group, the idea was to take some of the technologies that Dirk had developed and see if we could apply them to the real world of clinical cell therapy. At that time, we were working on optimizing certain receptors that we could put into patient-derived T cells that would target some types of human cancer. What is remarkable is

that over the course of the Focal Period, this technology has actually been applied in the first patients. We’re now treating patients with very defined cell populations, which is something that distinguishes the approach we’ve taken from other groups in the field. They’re not defining – at the level that we are – exactly what cell types they’re modifying to put into patients. The work in Dirk’s lab, particularly, has given us even deeper insight into the fundamental differences between the various cells we might use for therapy. This information will allow us in the future to be more selective about the cells that we engineer and improve outcomes – both in terms of safety and effectiveness.

**EG:** You mention that you’ve already introduced these cells into patients and successfully treated cancer that is resistant to other therapies – what are some of the results you’ve seen so far?

**SR:** We are treating patients who have blood cancers – leukemias and lymphomas – and we engineer the cells with a receptor that redirects them to recognize and kill those tumors. And as Dirk has said, this is a living therapy, so you may need to put in just a very small number of cells. And these cells will multiply in the patient until the tumor is eliminated. Using this approach, we’ve already treated more than 150 patients – patients who have failed all other treatments, and have no further treatment options. The remission rates – meaning complete elimination of measurable cancer cells – are as high as 90 percent for acute lymphoblastic leukemia. So this is really revolutionizing how we think about using the immune system to treat cancer. It comes back to the idea that by understanding the behavior and capabilities of the cells that you’re using in this therapy and their ability to LAST in the patient, we are entering a period in which we can examine expanding this cell therapy to many types of cancers. Dirk is already doing this in the clinic with infectious diseases, which doesn’t require engineering. He can select virus-specific T cells out of peripheral blood of stem cell donors, and use them to treat patients with certain viral infections after bone marrow transplants.

**DWH:** Ultimately, what really joins these two Focus Groups is that we are both using cells in our therapy concepts. And that's how Dirk, Stan and I actually got together. In our discussions, we were developing ideas about how to synergize our expertise from the fields of immune therapy and regenerative medicine to develop ground-breaking concepts – to really magnify both fields. The RM Focus Group approaches the topic from the perspective that you have a tissue defect – for example, a large bone defect based on a trauma or tumor removal. Or, from a soft tissue perspective, you have breast cancer that necessitates the removal of the breast – but then after the cancer is treated, you want to regenerate the tissue.

In regenerative medicine, we try to rebuild tissue by also using cells – yet with a different approach than the one which is currently being used in immune therapy. We combine cells with what is defined as a scaffold, because we really need the structural support to rebuild tissue, whereas with immune therapy based on the concept developed by Stan and Dirk, we inject T cells into the blood stream that subsequently proliferate and migrate to the site of infection or into the tumor tissue to destroy it. We start with something which is empty, and then we want to build up volume.

Our group specializes in using 3-D printing to fabricate patient-specific scaffolds. This technology allows us to run computer simulations to shape the volume as well as the form of the tissue we want to build. We use so-called additive biomanufacturing technologies to design and fabricate the scaffolds, and then add the patient's own cells with the goal of generating a lot of extracellular matrix. And then – similar to immune cell therapy – the cells and scaffold are implanted and interact with the patient's own body cells to regenerate the tissue. It is very important to have the surgical expertise to implant the tissue-engineered constructs (TEC) in the right way, as well as to provide optimal, post-operative treatment and to develop large preclinical models which mimic the human patient as closely as possible. That's why my Focus Group is actually hosted by the

TUM Clinic for Plastic Surgery and Hand Surgery, and co-directed by my host department chair, Prof. Hans-Günther Machens.

**EG:** Let's delve into the Focal Period and talk about what you've accomplished – and what your scope of cooperation will entail moving forward.

**DB:** The Focal Period concept is a great idea developed by the TUM-IAS. The Institute has given us the unique opportunity to generate international collaborations with researchers at TUM. I believe the next step now is to further tap the synergies between experts working in very different areas – and develop something unique in the international research and clinical landscape. We may be using cells for therapy differently, but in the end, we all work with living drugs as the basis of our research. I think the other similarity we share is that we often have to start our work with mixtures of cells – and with cell mixtures that are often not very well defined, or that differ substantially from donor to donor. We believe that if we have better-defined cells, we can translate this into better therapy. And this is a need we recognized to be of major importance in different fields of cell therapy and regenerative medicine.

**EG:** Maybe we could talk about this interdisciplinary approach – what were some of the insights gained during the workshops?

**SR:** The real key was, maybe, gaining deeper insight into the research, and an introduction into the various issues that we're studying. I'm an immunologist – I study lymphocytes, and I'm trying to understand the behavior of those lymphocytes. Yet we also had participants who were experts in biomaterial sciences who gave us insight into the scaffolds they're using to grow specific types of cells, and how those scaffolds can influence cell behavior. Others were experts in new technologies for editing the genome. So I think a key takeaway from the Focal Period is this: As top experts in our respective fields, we had the chance to get to know each other better – and better understand how the work being done by others might fit into our own.



Stan Riddell and Dirk Busch skyping with Dietmar W. Hutmacher.

» *A TUM-IAS Fellowship is not just a three-year stint where we're here to develop a program at TUM and then return to our respective universities and do our own thing alone again. TUM has the ambition to be a global leader in the field of cell and tissue engineering, and they are willing, then, to give additional resources to bringing different experts from different Focus Groups together to develop new ideas. And then really follow those ideas up – remember that we are all based at a medical facility at our respective universities – to deliver new therapies and concepts for patients.* « *Dietmar W. Hutmacher*

**DWH:** TUM and IAS leadership have a great vision in the support of both Focus Groups in the pursuit of becoming a leader in this emerging field. Stan and I are both Hans Fischer Senior Fellows, which allowed us to work together with TUM faculty in our respective Focus Groups.

The interdisciplinary element is key, yet what is also of utmost important is the vision of President Herrmann – that such a commitment from stakeholders is a condition sine qua non to developing a truly sustainable program at TUM.

**DB:** Perhaps we should add here that by bringing together such a diverse group of international experts and TUM faculty, we identified areas in which we are particularly strong here in Munich. For example, in regenerative medicine, there are many groups in Munich working with cutting-edge technologies on induced pluripotent stem cells. We also realized that the research being conducted here in Munich on genetic engineering in combination with large animal models is clearly at the forefront of international research. And I think these are fields with high relevance for future research activities in the field of cell and tissue engineering.

**EG:** You talked a bit about some new revelations – surprising overlaps – that resulted from the Focal Period. Are there areas of research where you'd say that as the collaboration continues, they might be something you need to give more emphasis to?

**SR:** There are many challenges in the cell and tissue therapy field – even though it has been around for a while, it is a field in evolution and we are all very interested in developing clinical applications. For us, perhaps, realizing that in both of our respective fields [CT and RM], there are applications that are at very different stages in their development. They face some similar challenges, and also some unique challenges. And part of bringing people together is that you hope the insights you get from different perspectives will help solve some of those challenges and perhaps move things forward more quickly.

**DB:** Perhaps to pick up on an earlier point: via our efforts to collaborate, we have recognized that there is a need to make our cell products more defined. This also came up repeatedly during the discussions that we had at the Focal Period meetings. Obviously, this is a point we all have to give more emphasis to.

**EG:** I was surprised that for the general public, things that sound so close to the clinic – for example, that we can generate organs, tissues or whatever – that in reality, there is still a lot of work to be done.

**SR:** What Dietmar is doing with developing the right micro and macro environment for cells to grow into – I think we haven't solved enough about in our area of research. In our collaboration with Dirk, we explored many of these three-dimensional structures that use approaches from tissue engineering.

I think it will also be important for us to understand better how to culture, grow and regulate the differentiation of the cells we want to put into patients. The Focal Period emphasized that research is still at a very early stage. The ideas are there, but the synergies that will arise from bringing experts from these disparate areas together will allow us to take steps forward that, perhaps, we've so far never thought about.

**DWH:** I would also say another challenge we face is that what often happens after these kinds of meetings is that a lot of ideas are exchanged – yet then everyone goes back to his or her own institution, back to the routine and current national projects – and the follow-up never happens. So the challenge is to keep the flame burning – to now further develop the ideas which were exchanged at this symposium and workshop into real action plans in the form of grant proposals, exchanges of Ph.D. students and post docs. What's nice to see? That the flame is being kept alive. Not just between our respective Focus Groups and host departments at TUM, but also in ongoing discussions between three other groups which attended the workshop to design new experiments and also look for funding. It is rewarding to see that some of the activities we discussed are really taking place now. The three of us are confident that when we meet again in 2017, we'll have concrete progress to report upon – for example, that three or four of the groups of experts who joined us for the Focal Period meetings have designed new projects and are making progress in answering the questions and challenges which were raised at the workshop.

**EG:** Could you go into more detail about upcoming projects on the horizon that have resulted from the collaboration between your Focus Groups?

**DB:** One of the projects that TUM and LMU – Ludwig-Maximilians-Universität München – together with the University of California – are discussing centers around the CRISPR (Clustered Regularly Interspaced Short Palindromic Repeats – CRISPR – are segments of prokaryotic DNA containing short, repetitive base sequences) Cas9 system for genetic cell engineering, including clinical cell production as well as transfer to large animal models.

**DWH:** Another project where I'm involved in is together with Dr. Luca Gattinoni at the National Institute of Health – National Cancer Institute (USA); he's quite interested in culturing immune cells in a co-culture system with mesodermal stem cells. He's looking for a substrate for the scaffolding to accomplish that. One of my post docs will join his lab for two or three months to bring our technology – how we culture cells

on scaffolds – to his lab. In another project, Stan, Dirk and I are already doing some work on how to expand immune cells on innovative scaffold systems to replace the current technology, which is based on culturing those cells on cell culture beads.

**EG:** Prof. Riddell, you’ve already detailed how you’ve developed cells for therapy in humans – and Prof. Huttmacher has already developed an engineered structure that’s been introduced into thousands of patients thus far. But you say we’re still in the infancy of this kind of cell and tissue engineering and that the reality of where we’re at with the technology and science differs from the expectations of the general public. Perhaps we could talk about that aspect – reality versus expectations?

**DWH:** Here is the big reality check – because what I try to explain to even a lot of my bioengineering colleagues is that we currently don’t have the technological ability to print an organ or even a tissue. And perhaps we never will. There’s a big misunderstanding about what we can do with this technology, as well as about where we need to direct the biology. The reality of what we can do: we can print scaffolds and can spike them with cells. But this is not yet a functional tissue. Cells form tissue, and therefore the whole concept will really only work when engineers, material scientists, molecular and cell biologists and clinicians work together, and everyone brings in his or her expertise. And again – when my engineering colleagues say they can print an organ – this is in Hollywood language – pure “La La Land” at this point in time!

So therefore, my approach is that with 3-D printing, we have a technology that allows us to print cells with what we call a very high spatial resolution. But then the biology needs to kick in and we need to guide the cells and produce an extracellular matrix, and after the matrix is produced in the right way, we can use it to form a tissue. And when the tissues are formed in the right way, then an organ is formed. But this can only happen inside the body – outside the body, we can print cells, and we can “free engineer” them by using bioreactors to direct cells to form a tissue-like



Dirk Busch, Dietmar W. Huttmacher and Stan Riddell

architecture. This again underscores the importance of the synergies we’re creating between my work and immune therapy research. For example, if I print a scaffold and I put mesenchymal stem cells onto the scaffold, and I transplant this, for instance, in a bone defect: even if I use the patient’s own cells, there will be an immediate immune response to the cells on the scaffold. So if one can now harness Stan and Dirk’s technologies by designing cells which we send through the body to the scaffold to modulate the environment, then the host cells reacting with that system might promote a microenvironment that we call a “proregenerative form.” That would be a great advance, especially for the regeneration of large defects. And that is the direction we are moving in – converging these technologies, because both have certain unique features. By combining them, we have a much stronger therapy concept for the regeneration of tissue and, perhaps one day, organs.

**EG:** It seems that your respective areas of research dovetail at many different levels – some quite unexpected – in the development of therapies in your respective areas of medicine?

**SR:** They do. Using immune cells to assist with the tissue regeneration like Dietmar just outlined was not an application that we’ve thought about for immune cell therapy – and that was the beauty of bringing this together.



We've been focused on destroying tissues, particularly cancerous ones or infected cells. But we know that immune cells are very important in healing wounds – and what Dietmar is saying is that there may be ways of using immune cells and engineering them to go to these places where you're trying to initiate repair. I think that definitely is an area for future research. It illustrates the strengths of bringing the two groups together.

**DB:** I think we are already very excited to see that, yes, we have been able to take some of the principles that we've learned from basic research to try to translate them into clinical applications. For example, to treat an infection. Stan was already pioneering this area of research quite a few years back, but when he started, there was perhaps the general belief – for many reasons – that it would require us to generate large amounts of these cells in order to do effective therapy. And what we're now seeing is that there is a strong regenerative capacity within defined subtypes of T cells. What we have learned – and this might be of relevance for many other cell therapy approaches as well – is that if you start out with the right cells, you might only need to generate a very low number of cells for therapy. Furthermore, using a low number of cells for therapy could even have advantages over using more, especially with respect to side effects and acute toxicities. So, unexpected aspects from different fields – including regenerative medicine – came together, which is now helping us to facilitate the generation of the most effective therapeutic cell products.

**SR:** The reason I believe the field is still in its infancy – even though we're already having some success in the clinic – is that cancer is a big problem. And we're treating a very small number of types of cancers, and what we've got, really, is the first evidence that says you can engineer immune cells to recognize and destroy a tumor in a patient. But that doesn't mean you can engineer immune cells to destroy EVERY tumor in every patient. There are different types of cancer: you have to identify targets and understand the microenvironment of those cancers. So there's still a lot of work to be done.



Dirk Busch

A cancer is often referred to as a wound that won't heal. Because, in fact, some of the ways in which a wound evolves – those same processes are initiated by cancer. And some of that is actually to shut down the body's immune response. We need to learn from our colleagues who are doing tissue regeneration and trying to repair wounds that won't heal – to understand how best to do that. We're early on, but I think we do have what I say is really first proof of principle for clinical applications, of the concepts and principles that we've worked on through the Focus Groups.

**DB/SR/DWH:** In closing we would like to thank TUM and especially the Institute for Advanced Study for providing us the opportunity to work together on the quest to develop 21st century therapy concepts.



Scientific Reports



## Scientific Reports

■	Advanced Computation and Modeling	60
■	Bio-Engineering and Imaging	72
■	Communication and Information	84
■	Control Theory, Systems Engineering and Robotics	90
■	Environmental and Earth Sciences, Building Technology	100
■	Fundamental Natural and Life Sciences	112
■	Gender and Diversity in Science and Engineering	144
■	Medical Natural Sciences	152
■	Surface, Interface, Nano- and Quantum Science	166

# Focus Group **High-Performance Computing (HPC)**

Prof. George Biros (University of Texas at Austin) | Hans Fischer Fellow  
Arash Bakhtiari (TUM) | Doctoral Candidate

## Scientific Reports



George Biros

### © Host

Prof. Hans-Joachim  
Bungartz  
Scientific Computing,  
TUM

### Alumni Members

Prof. Miriam Mehl  
(University of Stuttgart)  
Carl von Linde Junior  
Fellow

Prof. Markus Hegland  
(Australian National  
University)

Hans Fischer Senior  
Fellow

Dr. Christoph Kowitz,  
Dr. Valeriy Khakhutskyy,  
Dr. Benjamin Uekermann (TUM)

Doctoral Candidates

## Tackling the multi-challenge: from sparse grids to scalable fluid simulations

The Focus Group High-Performance Computing (HPC), hosted by Hans-Joachim Bungartz, addresses the emerging challenges of high-performance computing in science and engineering. In 2014, George Biros joined the group as a Hans Fischer Fellow to focus on the multi-core challenge. Alongside George Biros and Hans-Joachim Bungartz, the current Focus Group comprises the doctoral candidate Arash Bakhtiari. All three previous doctoral candidates working in the group, Valeriy Khakhutskyy, Christoph Kowitz, and Benjamin Uekermann, earned their doctoral degrees in 2016. At the beginning of the year, Christoph Kowitz, who has been working with Alumnus TUM-IAS Fellow, Markus Hegland from ANU in Canberra, successfully defended his dissertation “Applying the sparse grid combination technique in linear gyrokinetics.” Christoph Kowitz was followed by Benjamin Uekermann in October with the dissertation “Partitioned fluid-structure interaction on massively parallel systems,” which was supervised by Alumnus TUM-IAS Fellow Miriam Mehl (now a professor at the University of Stuttgart), and Valeriy Khakhutskyy in November with the dissertation “Sparse grids for Big Data: exploiting parsimony for large-scale learning,” supervised by Markus Hegland.

Each summer, George Biros visits TUM and collaborates with his doctoral candidate, Arash Bakhtiari. The team is developing fast solvers for transport in micro-circulation. This will improve our understanding of transport of a substance due to fluid motion, for example, to control localized drug delivery. It will also improve our understanding of oxygen transport in the alveole.

Arash Bakhtiari, together with Hans-Joachim Bungartz and George Biros, organized the minisymposium “Parallel Tree-Code Algorithms for Large Scale and Multiphysics Simulations” at the 2016 SIAM Conference on Parallel Processing for Scientific Computing (SIAM PP). The conference took place from April 12–15, 2016, in Paris. The aim of the minisymposium was to bring together computational scientists who work on large-scale tree codes and their applications. Tree codes are hierarchical data structures that are used for non-uniform discretization of partial differential equations. Moreover, tree codes are also used for integral-equation formulations and N-body methods. At the minisymposium, Arash Bakhtiari presented the results of his work as a doctoral candidate, namely, a parallel tree-based advection-diffusion solver.

During George Biros’ visit to TUM-IAS during the summer of 2016, he and Arash Bakhtiari worked on developing an arbitrary-order accurate time-marching scheme based on a spectral-deferred correction method. The method will be integrated with a Semi-Lagrangian advection-diffusion solver developed by Arash Bakhtiari, which is already arbitrary-order accurate in space and the related publication was accepted in “Proceedings of the International Conference for High Performance Computing, Networking, Storage and Analysis” [1].

The team also worked on extending the advection-diffusion solver to an incompressible Navier-Stokes solver, where the Semi-Lagrangian method will be applied to the nonlinear convective term while the Stokes term will be treated with a semi-

1 | In these three figures, we show an advection diffusion problem in a porous medium. The red and orange areas represent the solid phase. The streamlines visualize the velocity field, which corresponds to a stationary Stokes flow through the porous medium. The initial condition is the linear superposition of three Gaussians indicated by light blue, light green, and yellow.

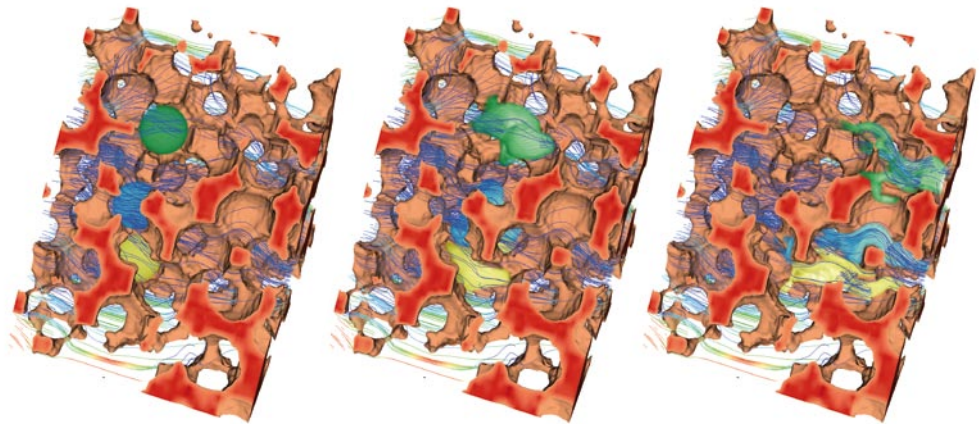

implicit volume integral equation formulation. Together with Philipp Neumann from the Chair of Scientific Computing at TUM, George Biros also organized the workshop “Hybrid Simulation Methods in Fluid Dynamics: Models, Software and Application.” The workshop took place from June 20–21, 2016, at the TUM-IAS, and it was designed to encourage collaboration and exchange between researchers from physics, computer science and engineering. At the workshop, state-of-the-art methods for hybrid flow simulation models, algorithms and software were discussed.

Moreover, George Biros held a compact course “Scalable Kernel Methods in Machine Learning” from June 23rd–July 1st, 2016: The focus of discussion revolved around machine learning-related topics such as supervised, unsupervised, and approximation algorithms in particular. Topics such as nearest neighbors, regression, density estimation and scattered data approximation were also discussed. Additionally, George Biros introduced kernel methods with the applicability and power in well-understood machine learning algorithms being explained. The course was open to all interested students and was attended by a diverse audience, including students from two Bavarian elite university programs, the Bavarian Graduate School of Computational Engineering (BGCE) and TopMath, as well as from the TUM M.Sc. program “Computational Science and Engineering.”

George Biros also gave a presentation at the TUM Informatics Department about his recent publication at the 2016 Supercomputing Conference (SC): “A Fast Solver for Constrained Diffeomorphic Image Registration” [2].

The SC ’16 took place from November 13–18 in Salt Lake City. The conference attracts a large and diverse community of participants ranging from researchers, scientists and application developers to agency program managers and journalists. The technical program comprises the heart of SC: Since only 20 percent of papers submitted for this part of the conference are accepted, it is highly competitive. The presentations, tutorials, panels and discussion forums featured in the SC technical program have been credited with inspiring all new and innovative areas of computing. Arash Bakhtiari and a team of co-authors made a successful submission to the 2016 conference, and Bakhtiari presented the paper “A parallel arbitrary-order accurate AMR algorithm for the scalar advection-diffusion equation” on behalf of the team [1].

#### Selected Publications

- [1] A. Bakhtiari, D. Malhotra, A. Raoofy, M. Mehl, H.–J. Bungartz, and G. Biros, “A parallel arbitrary-order accurate AMR algorithm for the scalar advection-diffusion equation,” in Proceedings of the International Conference for High Performance Computing, Networking, Storage and Analysis (SC 16), Salt Lake City, USA, 2016, no. 44.
- [2] A. Mang, A. Gholami, and G. Biros, “Distributed-memory large deformation diffeomorphic 3D image registration,” in Proceedings of the International Conference for High Performance Computing, Networking, Storage and Analysis (SC 16), Salt Lake City, USA, 2016, no. 72.

*Publications by this Focus Group can also be found in the section Publications of this report.*

# Focus Group **Complex Systems Modeling and Computation**

Prof. Yannis G. Kevrekidis (Princeton University) | Hans Fischer Senior Fellow  
Sindre Haugland, Felix Kemeth (TUM) | Doctoral Candidates

## Scientific Reports



Yannis G. Kevrekidis

### © Hosts

[Prof. Katharina Krischer](#)  
Nonequilibrium  
Chemical Physics, TUM  
[Prof. Oliver Junge](#)  
Numerics of Complex  
Systems, TUM

## Data-driven embeddings of complex dynamics

Complex processes are ubiquitous in nature and technology. And despite their complexity, there is currently a renewed effort to understand the dynamics of complex processes by leveraging advances and breakthroughs in machine learning and ‘big data’ science.

During the last year, our group worked on developing data-driven methods for embedding high-dimensional data from complex systems dynamic evolution. These data can stem from numerical simulations, or from experiments. Our approach is based on the assumption that there exists an intrinsic (not necessarily apparent at first sight) order in the data. We extract this order by using non-linear dimensionality reduction methods, such as diffusion maps. Hereby, the eigendirections of the diffusion maps approach span a space parametrized by the principal variabilities contained in the data.

For example, time series could be recorded at different points in space. As toy measurements, figure 1 shows time series (sampled every minute) of daylight at different places in Germany during one particular day. Each of these Boolean time series contains just ones and zeros: any entry is equal 1 if the sun is above the horizon at the corresponding place and time, and 0 otherwise. Due to the different locations of the cities, the individual time series are mutually different: The sun rises earlier in Berlin in the east and later in Dusseldorf and Cologne in the west of Germany. Additionally, in the winter, days are shorter in northern German cities such as Hamburg and Bremen, and longer in Stuttgart in the south. However, by just looking at the time series, it might be difficult for an observer to deduce that the time series contain two important geographic directions. Applying diffusion maps, on the other hand, reveals that these cities can be arranged in a two-dimensional space, with the axes correlating with the cities’ longitudinal and latitudinal positions.

This concept can be extended to high-dimensional dynamical systems. Solving PDEs numerically, one obtains time series at different points in space. Applying our method reveals which and how many dimensions are important to represent or reconstruct the data. As an illustration, a numerical solution of a Partial Differential Equation (PDE), the Kuramoto-Sivashinsky equation, is shown in figure 2. In fact, this solution is a modulated traveling wave. Therefore, this phenomenon can be described through two phases, the phase of the wave and the phase of the modulation, and any point in space and time thus corresponds to a location on a torus spanned by these two phases ( $\zeta$  and  $\theta$ ). Applying our methods to the numerical data, we can extract this torus in a purely data-driven manner from (a) purely temporal; (b) purely spatial; and (c) local spatiotemporal observations. Analogously, chimera states can also be classified using data-driven methods [1].

We believe that our approach will facilitate the analysis of other high-dimensional dynamical systems. Due to its generality, it will be beneficial to our understanding not only of simulation data, but also of data obtained from experiments. This interface, between the numerical methods and the data obtained from physical experiments is the subject of our current research.



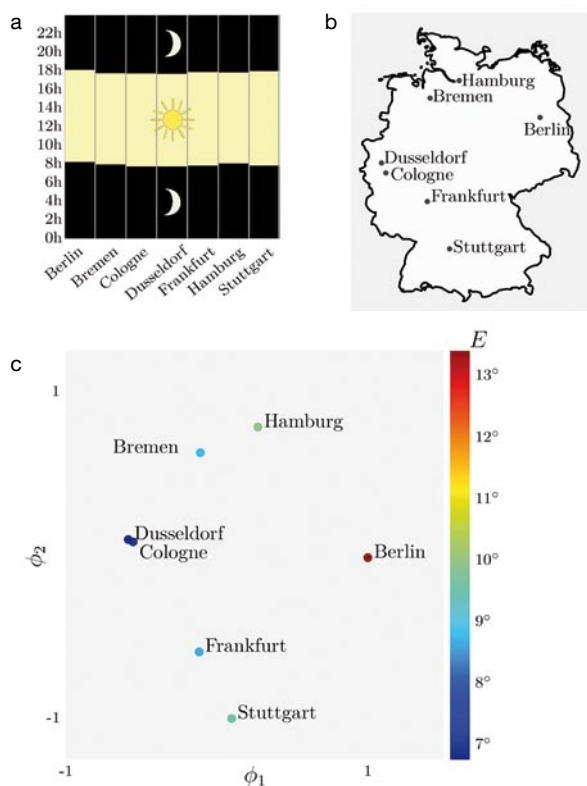

1 | (a) Time series (sampled every minute) of daytime (1, shown as yellow) and nighttime (0, shown as black) of different cities in Germany. (b) Map of Germany with the geographic positions at different cities. (c) Arrangement of these cities in a space spanned by the eigenmodes of the diffusion maps approach.

Another closely related problem is how to predict the future development of a temporally varying system. Again, many systems in nature and technology show complicated temporal behavior, and it is notoriously difficult to reliably predict their future evolution – in particular in the presence of uncertainties. For these systems, a more promising approach is to characterize all possible behaviors at once. Mathematically, this is captured by the notion of the maximal invariant set of the system. In the framework of this Focus Group, we proposed a new general approach for computing this set which overcomes several shortcomings of more traditional methods. In particular, our approach enables a systematic sensitivity analysis and is applicable to higher-dimensional systems [2].

*In close collaboration with Maximilian Patzauer, master student in the Focus Group and in Katharina Krischer's group (Nonequilibrium Chemical Physics, TUM).*

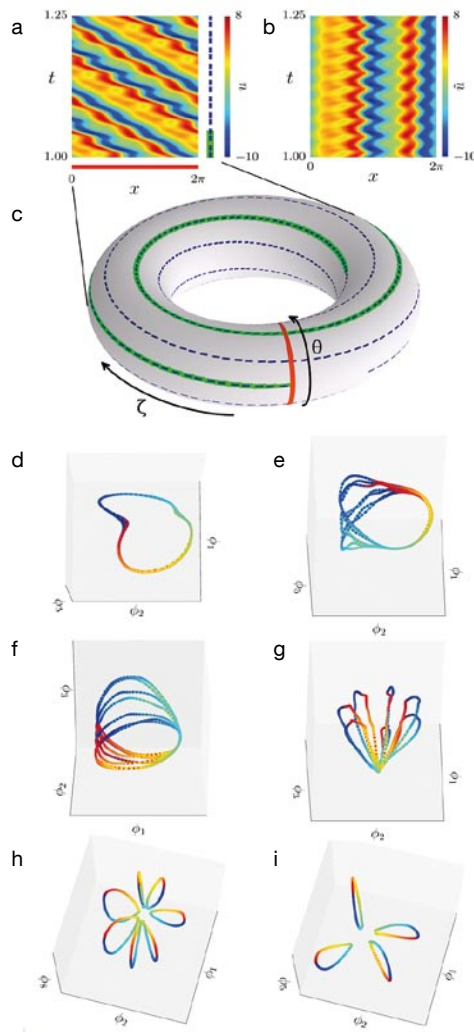

2 | (a) Data obtained from numerical simulations of the Kuramoto-Sivashinsky equation, showing modulated traveling waves. (b) The data of (a) shown in the moving frame of the traveling wave, revealing its modulation. (c) The torus spanned by the phase of the traveling wave and the phase of the modulation. (d-i) The unfolding of the torus using diffusion maps. Tuning the parameters of our approach, we are able to extract the torus which describes the dynamics.

### Selected Publications

- [1] F. P. Kemeth, S. W. Haugland, L. Schmidt, I. G. Kevrekidis, and K. Krischer, "A classification scheme for chimera states," *Chaos*, vol. 26, p. 094815, 2016.
- [2] O. Junge and I. G. Kevrekidis, "On the sighting of unicorns: a variational approach to computing invariant sets in dynamical systems," *Chaos*, 2017, accepted in 2016.

*Publications by this Focus Group can also be found in the section Publications of this report.*

# Focus Group Computational Mechanics: Geometry and Numerical Simulation

Prof. Alessandro Reali (Università degli Studi di Pavia) | Hans Fischer Fellow  
Davide d'Angella (TUM) | Doctoral Candidate

## Scientific Reports



Alessandro Reali

## © Host

Prof. Ernst Rank

Computation in  
Engineering, TUM

The main aim of this Focus Group is to take advantage of the unique approximation and geometric features of modern computational mechanics techniques, like isogeometric analysis and the finite cell method, as the way to go for creating efficient analysis tools for the effective simulation of complex problems like those related to additive manufacturing.

Historically, finite element analysis (FEA), which is the main numerical analysis tool used in engineering, was developed prior to the advent of computer-aided geometric design (CAGD), which is the main geometric design tool used today in engineering. The connection between the two tools relies on interfaces that are quite often not very efficient. As a result, building analysis-suitable geometries is estimated to take up to 80 percent of the overall analysis time for complex, CAGD-based engineering designs. Moreover, most FEA geometries are typically composed of simple objects, such as tetrahedra or hexahedra, which may not be able to represent highly sophisticated geometries with sufficient accuracy. This typically translates into very expensive simulations (and in some cases, even to modeling errors and misleading results), and such a gap definitely has to be dealt with.

Isogeometric analysis (IGA) was introduced in 2005 with the idea of performing analysis with splines – which are the basic ingredient of CAGD geometries – in order to make the construction of analysis-suitable geometries much simpler and more efficient. Another relevant and promising simulation framework is the recently developed finite cell method (FCM), which allows us to work with very complex and/or evolving geometries in a simple and effective way via the “immersed” concept. Both methodologies have been proven to be successfully applicable to practical problems, and we intend to use a combination of them to create efficient analysis tools for additive manufacturing problems, which constitute one of the most interesting modern challenges facing computational mechanics (CM).

In the first year of active work for our Focus Group, we concentrated on various aspects of the methodological basis of the numerical methods to be applied. In particular, an error estimator was successfully applied to drive adaptivity. Basically, areas of the domain that account for highest error are estimated and locally refined, meaning that the resolution is increased locally where needed. This work led to the first publication involving all members of the group [1] and we also intend to use such a technique for simulating the additive manufacturing process. In this direction, an application of the error estimator to IGA and FCM is a possible research line.

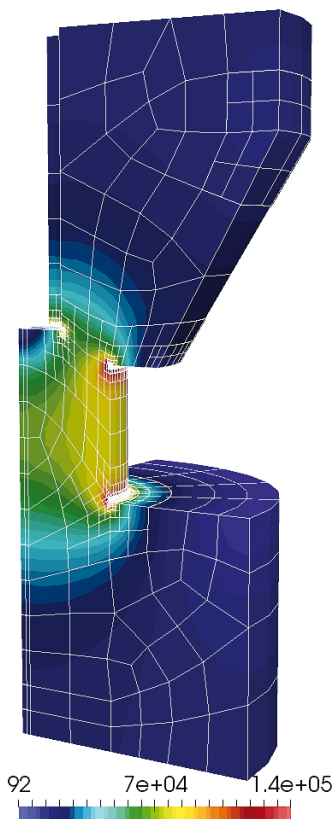

1 | Temperature flux on refined mesh.

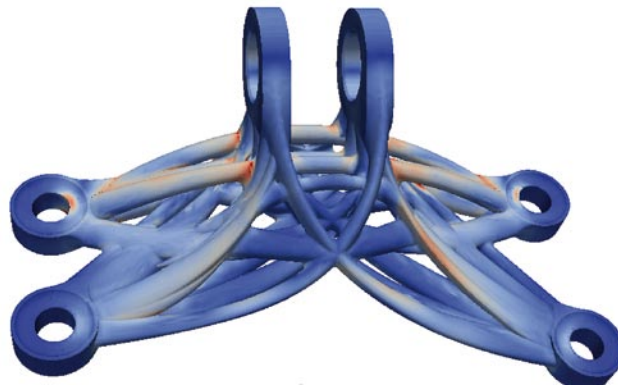

2 | Stress on engine bracket.

Furthermore, we developed a new approach on how to implement local refinement with IGA. In particular, we considered one of the best state-of-the-art local refinement techniques for IGA, and proposed a new implementation strategy. The proposed approach is a generalization of a well-established way of implementing IGA without local refinement, and it presents various advantages. As a result, we are currently formalizing this concept in a publication that we think has a lot of potential. Ultimately, this concept will allow us to integrate adaptive IGA in existing software developed by TUM experts – software that we intend to use for the simulation of additive manufacturing in the future.

Finally, we also investigated the simulation of phenomena governed by non-linear mechanics. Specifically, non-linear material models, solution techniques and associated problematics were studied and tested in the context of the simulation of mechanical response of fiber-reinforced hydrogel, in collaboration with the Focus Group Regenerative Medicine. In general, the non-linear behavior is of fundamental importance for accurately capturing effects of complex geometries and materials in practical engineering problems. Therefore, this will also constitute an important block for the simulation of additive manufacturing.

#### Selected Publication

- [1] D. D'Angella, N. Zander, S. Kollmannsberger, F. Frischmann, A. Schröder, E. Rank, and A. Reali, "Multi-Level hp-Adaptivity and Explicit Error Estimation," *Adv. Model. and Simul. in Eng. Sci.*, vol. 3, no. 33, 2016.

*Publications by this Focus Group can also be found in the section Publications of this report.*

# Focus Group **Advanced Stability Analysis**

Dr. Bruno Schuermans (GE Power) | Rudolf Diesel Industry Fellow  
Tobias Hummel (TUM) | Doctoral Candidate

## Scientific Reports



Bruno Schuermans

© Host

Prof. Thomas

Sattelmayer

Thermodynamics, TUM

## Background

The transformation of our power generation landscape from dominantly conventional to renewable technologies depends on the successful implementation of operationally flexible and clean gas turbines. The associated implementation of novel – i.e., turbulent lean premixed – combustion technologies is confronted with the combustion chamber exhibiting a sensitive susceptibility to thermoacoustic instabilities. Physically, these instabilities evolve from constructive, self-sustaining feedback couplings between the combustor's acoustic oscillations and the flame's heat release rate fluctuations, which manifest as pressure pulsations through the chamber. The pulsations need to be avoided, as they can be detrimental to the engines' hardware, and also hamper operational flexibility and low-emissivity.

In particular, high-frequency pulsations occurring within the kilohertz frequency regime have been increasingly threatening smooth gas turbine operation, and have thus become a focus of attention for engineers and researchers in the field. These pulsations unfold in a multidimensional manner throughout the combustor, which suggests a significant increase in complexity regarding the understanding and modeling of the underlying physics compared to one-dimensional, low-frequency counterparts.

In the context of a TUM-IAS Rudolf Diesel Fellowship, Bruno Schuermans is taking on the challenge of unraveling high-frequency combustion instabilities in gas turbine combustors together with Thomas Sattelmayer of TUM's Chair for Thermodynamics. For this purpose, an extensive network ranging from academic (TUM-IAS), industrial (ALSTOM & AG TURBO) and government (BMW) research frameworks have been established. Within this framework, four doctoral candidates are collaboratively conducting high-frequency thermoacoustic research at TUM with experimental, numerical, and theoretical emphases.

## Recent activities

This year 2016 was devoted to the development of system identification tools in order to extract key thermoacoustic system parameters from measurement data. The specific parameter we have sought to identify is the linear growth rate, which can be thought of as an integral value of the thermoacoustically generated energy feeding the acoustic oscillations. Knowledge of these growth rates is of high technical relevance, as it constitutes a crucial input for the design of instability suppression devices and also contributes to ensuring stable and reliable gas turbine operation. The development of the identification approach occurred in three steps:

## 1. Derivation of a stochastic differential equation

The first step comprised the derivation of a system of stochastic differential equations (SDE) that govern the limit cycle dynamics of the self-sustained pressure oscillations constituted by a rotating transversal mode. For this, the mathematical starting point is given at the autonomous oscillator equation, which describes the linear, nonlinear and stochastic thermoacoustic behavior of the concerned combustor:

$$\ddot{\eta} + \omega^2 \eta = \nu \dot{\eta} - \kappa \dot{\eta} \eta^2 + \xi$$

Here, the acoustic pressure oscillation (which was recorded in this case using pressure sensors mounted at the chamber wall) is denoted by the variable  $\eta(t)$ , and the oscillation eigenfrequency  $\omega$ . Turbulent combustion noise is included by a white noise source  $\xi(t)$ , while system parameters  $\nu$  and  $\kappa$  represent the desired growth rate and a semi-empirical saturation constant, respectively. The desired SDE is obtained by employing temporal and stochastic averaging procedure based on the widely known Krylov-Bogoliubov theorem:

$$\dot{A} = \nu A - \frac{\kappa}{3} A^3 + \frac{\Gamma}{A} + \xi$$

The conservation variable  $A(t)$  presents the envelope time trace associated with the pressure oscillations. Note that the envelope is stochastically perturbed due turbulent combustion noise, which is included in the SDE through the terms noise intensity constant  $\Gamma$  and white noise signal  $\xi(t)$ . The determination of  $A(t)$  from measured data is achieved by Hilbert transforming the recorded pressure signal  $\eta(t)$ .

## 2. Analytical solutions and parameter extraction methodology

In order to extract the growth rates from measurement data, an analytical solution associated with the SDE is required. For this purpose, the amplitude trace  $A(t)$  was linearly decomposed into a constant  $\bar{A}$  and perturbation term  $A'(t)$ , i.e.

$$A(t) = \bar{A} + A'(t) \rightarrow A' \ll \bar{A}$$

Physically, this decomposition can be justified if the perturbation of the constant oscillation amplitude due to noise effects is small – which is a reasonable assumption for practical systems. Respective substitution and manipulations leads to a first order linear differential equation governing the perturbed amplitude:

$$\dot{A}' = -2\nu A' + \frac{\Gamma A'}{\bar{A}^2} + \xi$$

Employing Fourier and spectral methods allows us to derive the analytical solution:

$$k_{A'A'}(\tau) = \exp(-2\nu\tau)$$

This is formulated as the autocorrelation function of the perturbed amplitude containing the parameter (i.e., the growth rate  $\nu$ ) sought to be identified. Fitting this analytical expression against the autocorrelation of the perturbed amplitude of the measured pressure oscillations emerges the growth rate.

### 3. Verification studies

The employability of the developed system identification methodology was verified using artificial data, which we generated via time domain simulations of a Reduced Order Model (ROM, developed in the initial phase of this project by the Focus Group) of a representative combustion system.

This system (schematically shown in figure 1) is comprised of a lab-scale, premixed combustor that exhibits self-sustained high-frequency instabilities.

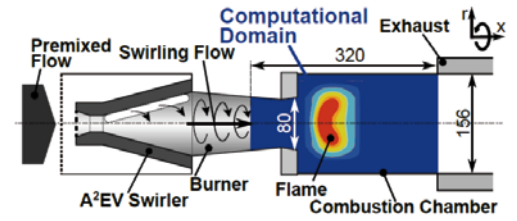

1 | Schematic of experimental combustor.

The concerned growth rate was manually defined within the ROM framework, and was thus implicitly contained in the simulation data. Several realistic operation points were defined and numerically integrated to yield the necessary pressure oscillation traces. The autocorrelation of the amplitudes of these traces was computed, and the desired growth rates were then retrieved by respective fitting using analytical expressions of the autocorrelation.

A sample time trace of the envelope of an unstable simulated operation point is shown in figure 2, while the corresponding autocorrelation, along with the reconstruction through the fitted quantities, is presented in figure 3. The relative fit error between prescribed and extracted values for all concerned cases (cf. figure 4) remain below 5 percent. Consequently, the identification method can be rendered as accurate, and is therefore readily applicable to experimental and real engine data.

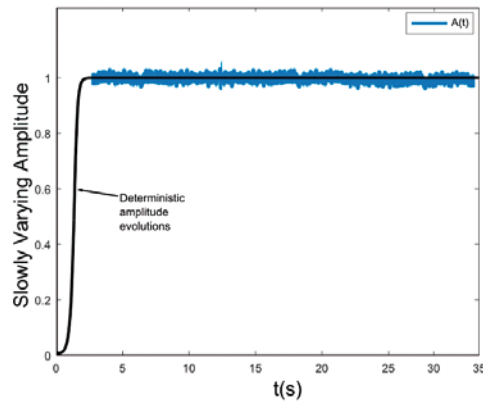

2 | Simulated amplitude time trace.

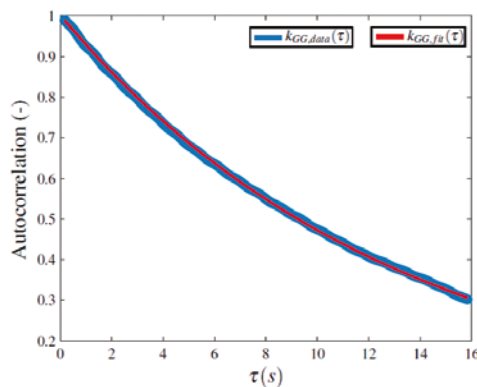

3 | Reference and reconstructed auto-correlation plots.

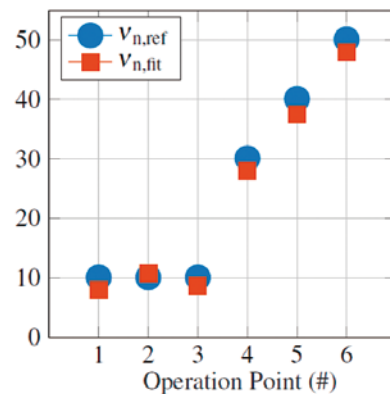

4 | Reference and extracted growth rate values.

## International Symposium “Thermoacoustic Instabilities in Gas Turbines and Rocket Engines: Industry meets Academia”

In 2016, we held a four-day scientific symposium on advances in thermoacoustic oscillations in gas turbine and rocket combustors at the TUM-IAS. Thomas Sattelmayer initiated and hosted the event together with Bruno Schuermans. The symposium connected the research communities of gas turbine and rocket engines thermoacoustics as well as academic institutions and industrial companies in order to identify overlapping research areas, and to initiate collaborations. Topics discussed and presented in scientific paper sessions covered physical mechanisms, analysis approaches, system optimization and many more. This successful event is described in detail on page 26 of this report.

### Reference

- [1] T. Hummel, F. M. Berger, B. Schuermans, and T. Sattelmayer, “Extraction of Linear Growth and Damping Rates of High-Frequency Thermoacoustic Oscillations from Time Domain Data,” in Proceedings of the 2017 ASME Turbo Expo, Charlotte, USA.

### Selected Publication

- [2] T. Hummel, F. M. Berger, B. Schuermans, and T. Sattelmayer, “Theory and Modeling of Non-Degenerate Transversal Thermoacoustic Limit Cycle Oscillations,” in Proceedings of the 2016 International Symposium on Thermoacoustic Instabilities in Gas Turbines and Rocket Engines: Industry meets Academia, Munich, Germany.

*Publications by this Focus Group can also be found in the section Publications of this report.*

# Focus Group **Uncertainty Quantification and Predictive Modeling**

Prof. Nicholas Zabaras (University of Notre Dame) | Hans Fischer Senior Fellow  
Markus Schöberl (TUM) | Doctoral Candidate

Scientific Reports



Nicholas Zabaras

© Host

Prof. Phaedon-Stelios  
Koutsourelakis  
Continuum Mechanics,  
TUM

## Uncertainty quantification in multiscale modeling

Simulations at the level of atoms or molecules have become an essential tool for gaining insight into physical processes and designing new materials. The complexity of all-atom models arising primarily from the extreme range of spatiotemporal scales that come into play, outpace available computational resources. To overcome this limitation, coarse-grained (CG) models which utilize fewer degrees of freedom and/or simplified interactions have come into prominence. CG models should still capture the overall macroscopic behavior while integrating out less relevant fluctuations [1]–[2].

A multitude of concepts for building CG models have appeared over the years. In a typical bottom-up approach, several atoms are grouped together and described by a single pseudo-particle in the coarse model. Appropriate potentials are learned in order to model the interactions between such macro-particles. Notably, the mapping from the fine to the coarse scale is a non-parametrized many-to-one projection unavoidably leading to information loss. The computation of predictions in the form of point-estimates does not account for model uncertainties induced by the previously defined mapping and the availability of finite-sized training datasets. Furthermore, such formulations are unable to properly reconstruct the fine-scale picture from the CG description.

To address these limitations, we previously developed a novel, data-driven approach called predictive coarse graining (PCG), which implicitly defines the CG variables through a probabilistic coarse-to-fine map. This is complemented by a probabilistic model of the interactions between the CG variables (figure 1). Using all-atom simulation data, a distribution of the model parameters is learned, which is in turn used to compute probabilistic estimates of observables. These reflect the uncertainty induced by the finite-sized training data set and the coarse-to-fine map. The proposed scheme was assessed by coarse-graining lattice systems as well as water.

In a lot of problems, more than 80 percent of the total computation time is spent in the simulation of water as a solvent. A major task we tackled over the last year was building a sparse, predictive model for SPC/E water. Observables from the SPC/E model, e.g., the radial- and angular-distribution functions, coincide with the predictions by PCG. More importantly, the predictions are enriched by credible intervals reflecting the aforementioned sources of uncertainty, as depicted in figure 2. We employed a flexible coarse potential defined by a linear combination of feature functions. Sparse Bayesian learning techniques revealed the most prominent features. In addition, we explored the possibility of sequentially increasing the flexibility of the coarse potential by adding feature-functions. The selection of such functions was performed on the basis of an information-theoretic objective that was developed.

The coarse-graining of SPC/E water relies on a physically motivated mapping since the local CG variables reflect the center of mass of the water molecules. Physical insight and intuition in complex structures might not be accessible without excessive simulations of all-atom models. It is therefore desirable that the discovery of an



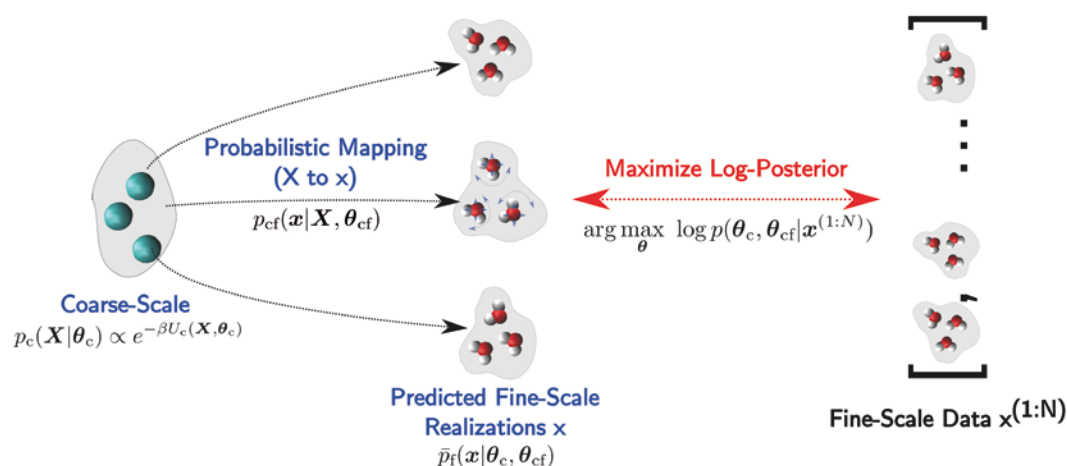

1 | Predictive coarse-graining (PCG) approach.

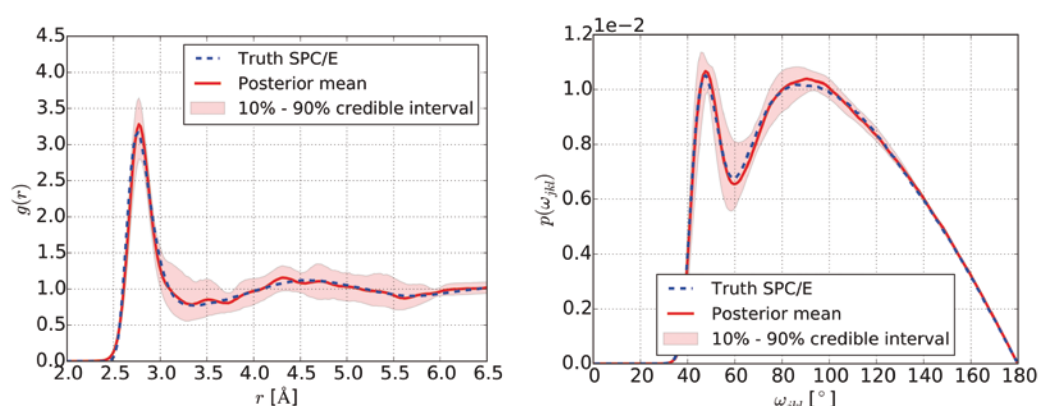

2 | Probabilistic prediction with PCG compared to the SPC/E reference of the radial- and angular-distribution functions.

appropriate set of CG variables is automated. Our group is currently investigating such possibilities in the context of peptide simulations. In particular, we are examining the use of global CG variables, which in contrast to the local structure adopted thus far, have the potential of revealing macroscopic features of the peptide chain and leading to more compact and physically-intuitive representations.

## References

- [1] International Symposium: Big Data and Predictive Computational Modeling, TUM Institute for Advanced Study, May 2015. [www.tum-ias.de/bigdata2015/](http://www.tum-ias.de/bigdata2015/)
- [2] P. S. Koutsourelakis, N. Zabarar, and M. Girolami, "Symposium Yields Insights on Big Data and Predictive Computational Modeling," SIAM News, July 2015.

## Selected Publication

- [3] M. Schöberl, N. Zabarar, and P. S. Koutsourelakis, "Predictive Coarse-Graining," J. Comput. Phys., vol. 333, pp. 49–77, 2017, accepted in 2016.

*Publications by this Focus Group can also be found in the section Publications of this report.*

# Focus Group Human-Machine Collaborative Systems

Prof. Gregory D. Hager (Johns Hopkins University) | Hans Fischer Senior Fellow  
Christian Rupprecht (TUM) | Doctoral Candidate

## Scientific Reports



Gregory D. Hager

### © Host

Prof. Nassir Navab

Computer-Aided  
Medical Procedures &  
Augmented Reality, TUM

1 | In [1] we predict the state of kitchen tools (top) or a daVinci robot (bottom) from the video feed of a camera and use that to identify the actions performed by the human.

The Focus Group Human-Machine Collaborative Systems is interested in analyzing human task performance, for example during robotic surgery, with the goal of creating ways to answer very fundamental questions such as: “What are the basic components of surgery?” or “How can we model and automatically recognize those components?” and “How can we assess the quality or skill of execution?” Sensors are often critically important in robotics applications. For example, pressure sensors are vital for manipulation tasks, and tool tracking supports visual servoing (VS, or vision-based robot control). However, there are many applications where the ideal sensing is too impractical or too costly to deploy in real-world settings. For instance, in a future kitchen ([www.conceptkitchen2025.com](http://www.conceptkitchen2025.com)), it might be beneficial to attach motion sensors to all tools to support monitoring or control, but retrofitting every kitchen at scale is simply impractical due to a combination of cost, data acquisition and synchronization overhead as well as physical constraints in instrumentation. A practical alternative would be to mount a video camera to observe the scene, but current methods for video tracking and action recognition generally achieve worse performance than their counterparts using domain-specific sensing. Recently, we were able to predict the state (position and velocity of grippers, etc.) of the daVinci robot just from the camera feed. This enabled us to classify the actions of the surgeon during the procedure into different tasks. This can be used to perform skill assessment, for example [1]. Additionally, in the kitchen scenario, we were able to use data from the camera feed to predict which tool was currently in use to infer what step of the recipe the user is executing.

Train: video + sensors      Test: video + virtual sensors

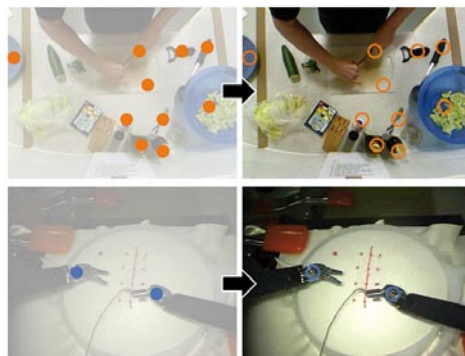

In this work, we were not only able to improve the state-of-the-art in human pose estimation, but could also contribute a novel, theoretical insight to “deep learning,” a machine learning method that has become popular in the last three years.

In a related set of work, we have also investigated the ability of recurrent neural networks (RNNs) to assess the progress and quality of a surgical performance based on information gathered about tool movement. We have shown in [2] that RNNs are able to be trained on moderate sized data sets, and are able to recognize manipulative components of a surgery with performance that exceeds all other methods which have been applied on publically available data sets. Figure 2 shows representative results from the method on two data sets.

Finally, when interacting with humans or with many common environments, we often need to deal with uncertainty. When presented with an image, one might deduct: “This is either an alpaca or a llama, but it is definitely not an elephant.” When predicting the behavior of other drivers on the road or at an intersection, we as human drivers tend to make good guesses based on expectations learned over time.

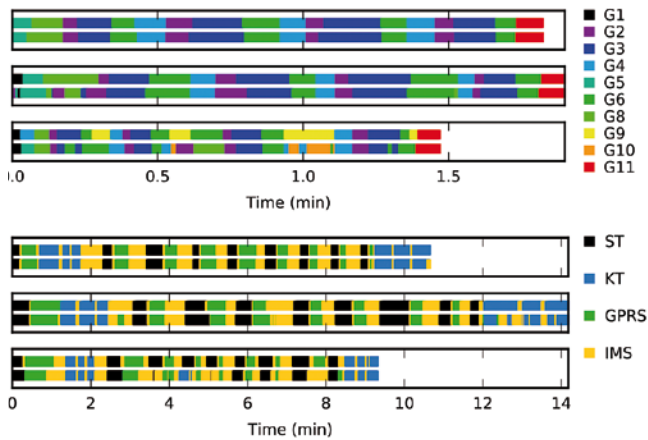

2 | In [2] we generate qualitative results for two data sets: JIGSAWS (top) and MISTIC-SL (bottom) using a bidirectional LSTM. For each dataset, we show results from the trials with highest accuracy (top), median accuracy (middle), and lowest accuracy (bottom). In all cases, ground truth is displayed above predictions.

For example: “They are in the right lane, so they might continue straight or take a right turn soon.” Uncertainty also models incomplete information. When the handle is not visible, we might not be able to tell if an image depicts a mug or a cup. In short, when tasked with a situation that we are not sure about, we tend to produce multiple plausible hypotheses.

In our most recent work [3], we show how we can model multiple hypotheses using the predictive power of deep neural networks. We observe that when we extend neural networks to be able to predict multiple outcomes, we can correlate the certainty of the prediction with the variance in the hypotheses. Figure 3 shows that the right arm of the human which is not visible in the picture it predicted in multiple different poses, while the shoulders, which are easy to locate, remain stable. This paper was under review at the time of publication, but a preprint is already available. Overall, we were able to deepen the understanding and performance of our systems, which will be the foundation of further research into enabling easy and meaningful interaction between smart robots and humans.

*In close collaboration with Gregory Hager’s doctoral candidate, Robert DiPietro, from Johns Hopkins University, Maryland, USA, who is spending one year at TUM.*



3 | We show the predicted human pose for an image with (a) one (b) two (c) five (d) ten predictions. We can observe the uncertainty of the hand positions in the high variance with multiple predictions. Joints like shoulders and hips are easy to detect and also vary much less over the predictions.

### Selected Publications

- [1] C. Rupprecht, C. Lea, F. Tombari, N. Navab, and G. D. Hager, “Sensor substitution for video-based action recognition,” in Proceedings of the IEEE/RSJ International Conference on Intelligent Robots and Systems (IROS), Daejeon, Korea, 2016, pp. 5230–5237.
- [2] R. DiPietro, C. Lea, A. Malpani, N. Ahmidi, S. S. Vedula, G. I. Lee, M. R. Lee, and G. D. Hager, “Recognizing surgical activities with recurrent neural networks,” in Proceedings of the International Conference on Medical Image Computing and Computer-Assisted Intervention (MICCAI), Istanbul, Turkey, 2016, pp. 551–558.

### Reference

- [3] C. Rupprecht, I. Laina, M. Baust, F. Tombari, G. D. Hager, and N. Navab, “Learning in an uncertain world: representing ambiguity through multiple hypotheses,” 2017.

*Publications by this Focus Group can also be found in the section Publications of this report.*

## Focus Group **Microfluidic Design Automation**

Prof. Tsung-Yi Ho (National Tsing Hua University) | Hans Fischer Fellow  
Chunfeng Liu (TUM) | Doctoral Candidate

### Scientific Reports



Tsung-Yi Ho

### © Host

**Prof. Ulf Schlichtmann**

Electronic Design  
Automation, TUM

## Design automation solutions for enabling biochemistry on a chip

Within the Microfluidic Design Automation Focus Group, we are focused on developing computer-aided design (CAD) tools for hardware and software co-design and the cyber-physical system (CPS) integration of microfluidic biochips. A biochip is a collection of miniaturized test sites (microarrays) arranged on a solid substrate that permits many biochemical tests to be performed simultaneously in order to achieve higher throughput and speed. Moreover, microfluidic biochips manipulate continuous liquid flow through microfabricated channels by utilizing external pressure sources, external mechanical pumps or integrated mechanical micropumps. Microfluidic biochips have revolutionized the traditionally slow and error-prone biochemical experiment flow by manipulating nanoliter volumes of fluids precisely. With this miniaturization, bioassays can be scaled down, and genomic bioassay protocols such as nucleic-acid isolation, DNA purification, and DNA sequencing have been successfully demonstrated with these chips.

As more bioassays are executed concurrently on a single biochip, system integration and design complexity are expected to increase dramatically. Recent advances in manufacturing technologies have enabled the density of mechanical micropumps to reach one million per  $\text{cm}^2$ . There is now a need to deliver the same level of CAD support to biochip designers that the semiconductor industry today takes for granted. These CAD tools will allow designers and chip users to harness the new technology that is rapidly emerging for integrated biofluidics. Our Focus Group is working to develop CAD tools for hardware and software co-design and cyber-physical system integration of microfluidic biochips. In addition, this work will offer researchers at TUM a bridge between the electronic chip and system design industries on the one hand, and the biomedical and pharmaceutical industries on the other.

Over the past year, we developed an automatic synthesis method for continuous-flow microfluidic biochips, which proposed the first planarity-guaranteed architectural model and the first physical-design module models for important microfluidic components. Continuous-flow microfluidics have evolved rapidly in recent decades due to their advantages in effective and accurate control. However, complex control results in complicated valve actuations. As a result, sophisticated interactions between control and flow layers substantially raise the design difficulty. These interactions appear with the actuation of valves, which means that the interaction needs to be considered wherever a valve is implemented.

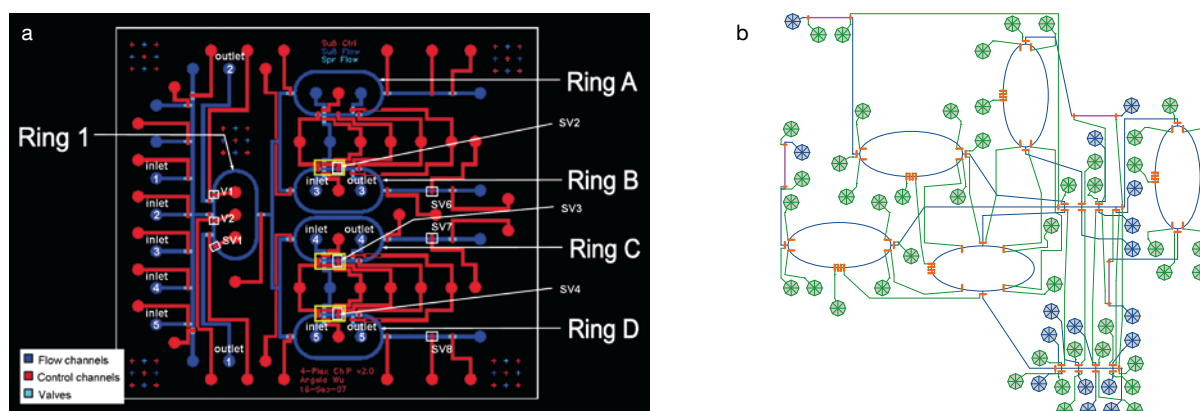

1 | Chromatin Immunoprecipitation (ChIP) design: (a) Manual [1], (b) Columba [2].

In our work, we have proposed the physical-design module models for mixers, reaction chambers, switches and ports, which included all the valve implementation on a chip and thus provided a basis for modeling all the interactions between control and flow layers. Furthermore, we have designed a planarity-guaranteed architectural model, which ensured the feasibility of place-and-route solutions without unexpected overlapping among devices and channels. Based on the above, we developed a co-layout synthesis tool called “Columba,” which focuses on the whole layout containing both layers from the very beginning, thus enabling designs with a global view. Figure 1 shows the comparison between the manual design and the automatic design by Columba for Chromatin Immunoprecipitation (ChIP) design. Experimental results demonstrate that we can effectively reduce the chip area, thus minimizing both manufacturing costs and the completion time required for an assay.

*In close collaboration with Tsun-Ming Tseng and Bing Li who are working as doctoral candidate and postdoctoral researcher at Ulf Schlichtmann’s chair of Electronic Design Automation, TUM.*

#### Reference

- [1] A. R. Wu et al., “Automated microfluidic chromatin immunoprecipitation from 2,000 cells,” *Lab Chip*, vol. 9, no. 10, pp. 1365–1370, 2009.

#### Selected Publication

- [2] T.-M. Tseng, M. Li, B. Li, T.-Y. Ho, and U. Schlichtmann, “Columba: Co-layout synthesis for continuous-flow microfluidic biochips,” in *Proceedings of the 53rd ACM/EDAC/IEEE Design Automation Conference (DAC 2016)*, Austin, USA, 2016, no. 147, pp. 1–6.

*Publications by this Focus Group can also be found in the section Publications of this report.*

# Focus Group Phase-Contrast Computed Tomography

Dr. Kaye S. Morgan (Monash University) | Hans Fischer Fellow

Dr. Thomas Koehler (Philips Research Laboratories) | Rudolf Diesel Industry Fellow

Prof. Franz Pfeiffer (TUM) | Carl von Linde Senior Fellow

Regine Gradl (TUM) | Doctoral Candidate

## Scientific Reports



Kaye S. Morgan



Thomas Koehler



Franz Pfeiffer

© Hosts  
Prof. Franz Pfeiffer  
Biomedical Physics,  
TUM,  
Prof. Ernst Rummeny  
Radiology, TUM

In conventional x-ray imaging, the image contrast is formed by x-ray attenuation and reflects the physical interactions of photoelectric absorption and Compton scattering. Both of these interaction processes are modelled conveniently by interpreting x-rays as photonic particles. If, in contrary, x-rays are described as electromagnetic waves, other (wave-optical) interaction effects occur, and yield to diffraction, refraction, phase shift and scattering. Our Focus Group aims at exploiting the latter-mentioned wave-optical interactions of x-rays with matter for bio-medical research and clinical applications. Preclinical results obtained in living mice have thus far indicated that the scattering signal – also called the dark-field signal – generated by lung tissue may provide very important, supplemental information for the assessment of structural diseases of the lung tissue: for instance, chronic obstructive pulmonary disease (COPD) [2].

One focus for us in 2016 was therefore to demonstrate that the technology works in the parameter range that is relevant for medical x-ray imaging, in particular at x-ray energies in the range from 70 to 120 kVp and for human-sized objects. This goal was achieved in a newly developed x-ray projection imaging setup, the results of which were initially published at the RSNA conference in Chicago in November 2016 [3]–[4].

Alongside our research activities into the development of future clinical applications, we are exploring the ability of phase and / or dark-field contrast x-ray imaging to be used as a tool in biomedical research: for example, this technology can be used to reveal soft tissue structure or function via a high-speed image sequence. A number of such studies using these imaging modalities have been conducted at bright, highly coherent synchrotron x-ray sources.

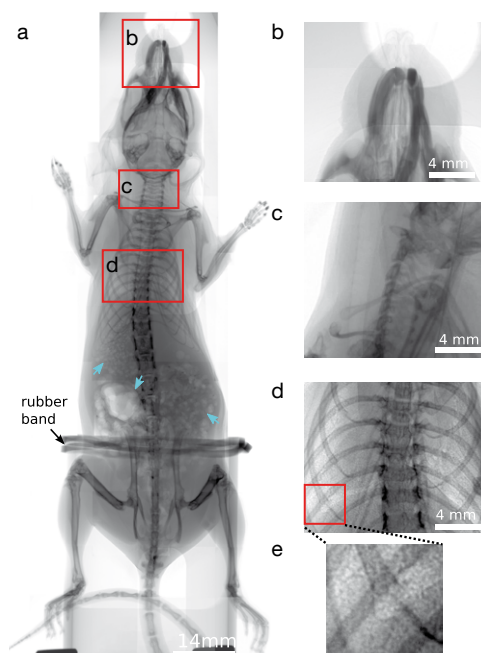

1 | (a) an ex-vivo mouse imaged with propagation-based X-ray phase contrast. The red boxes highlight the areas imaged in panels b–d. In the stomach, gas bubbles are visible (highlighted with blue arrows). (b) The nasal airways. (c) Trachea region. (d) Lung. (e) is a magnification of the red box in d and shows the speckle pattern which results from the air sacs in the lungs, the alveoli.



2 | A mini off-site workshop was held in Sudelfeld in May 2016, bringing together almost 30 physicists, mathematicians, engineers, and physicians from TUM Physics, the university hospital Klinikum rechts der Isar, and Philips.

The second area of focus for our group in 2016 was to translate these dynamic / functional imaging techniques from the synchrotron to the university laboratory, so that the associated increased availability could enable a range of longitudinal and extended studies. This was achieved using the world's first high-flux x-ray source based on inverse Compton scattering, the Munich Compact Light Source (MuCLS). It is around 200 times smaller in size than a synchrotron, and situated in the IMETUM building at the TUM Garching campus. With this new technology, we successfully captured the first propagation-based, phase contrast images of a mouse [1], as well as sequences of biomedical function.

Finally, two additional events marked the success and outreach our Focus Group accomplished over the past year (figures 2, 3).



3 | The installation of two new research CT systems at the university hospital Klinikum rechts der Isar: The installation of the Philips IQON system are attending from left to right: Markus Schwaiger (Director university hospital Klinikum rechts der Isar), Peter Henningsen (Dean TUM School of Medicine), Franz Pfeiffer (Biomedical Physics), and Ernst Rummeny (Radiology).

## Reference

- [1] R. Gradl et al., "Propagation-based phase-contrast X-ray imaging at a compact light source," submitted, 2016.

## Selected Publications

- [2] F. Pfeiffer et al., "Pre-clinical dark-field CT imaging of small-animal lung disease models," Proceedings of the 4th International Meeting on image formation in X-ray CT, Bamberg, Germany, 2016.
- [3] K. Hellbach et al., "Depiction of pneumothoraces in a large animal model using x-ray dark-field radiography," Proceedings of the Annual Meeting of the Radiological Society of North America, RSNA, Chicago, USA, 2016.
- [4] L. Gromann et al., "A first feasibility study on phantom samples and *in vivo* pigs," Proceedings of the Annual Meeting of the Radiological Society of North America, RSNA, Chicago, USA, 2016.

# Focus Group Image-based Biomedical Modeling

Prof. Bjoern Menze (TUM) | Rudolf Mößbauer Tenure Track Professor

Dr. Vasileios Zografos (TUM) | Postdoctoral Researcher

Esther Alberts, Jana Lipkova, Markus Rempfler (TUM) | Doctoral Candidates

## Scientific Reports



Bjoern Menze

© Host

Image-based Biomedical Modeling, TUM

The Focus Group Image-based Biomedical Modeling develops computational algorithms that analyze biomedical images using statistical, physiological, and biophysical models. The work strives to transform the descriptive interpretation of biomedical images into a model-driven analysis – one that infers properties of the underlying physiological and patho-physiological processes by using models from biophysics and computational physiology. A related effort is the application of such models to big clinical databases in order to learn about the correlations between model features and disease patterns at a population scale. In this work, the main focus is on applications in clinical neuroimaging and the personalized modeling of tumor growth.

## Clinical neuroimage analysis

The first direction of research is the modeling of processes underlying images acquired in common diseases of the brain. We are focusing on the analysis of images acquired in glioma and stroke patients, including the development of algorithms for the analysis of brain lesions as well as new computational techniques for extracting vascular networks from angiographic images. The main sources of information we are using include multimodal and multi-parametric clinical image data featuring magnetic resonance, position emission tomography and computer tomography scans. To quantify image patterns visible in patients with brain tumors or strokes, we developed an algorithm that automatically segments lesions using machine-learning techniques [1]–[2]. We also began exploring the use of machine-learning techniques from computer vision and image analysis for improving magnetic resonance (MR) imaging sequences. Instead of reconstructing MR relaxation parameter maps, we have illustrated how to directly infer brain tissue maps using novel “MR fingerprinting” sequences [3].

## Disease progression models

The second direction of our work deals with the task of optimal oncological staging. It includes the anatomical annotation of large field-of-view images, such as abdominal scans or whole-body images; the detection of lesion across modalities and in repeated scans; and the analysis of individual lesions using pathophysiological models. Emphasis is put on the clinical applicability of our work, and algorithms are supposed to scale well to large data sets, with the target of enabling the development of population-wide disease progression models. To this end, we have developed new methods for the automated annotation of abdominal CT volumes, for use in evaluating image data acquired in the monitoring of patients with liver tumors. More specifically, we have explored the use of deep-learning techniques [4], and worked towards establishing large bases for liver and liver lesion segmentation that can be used in evaluating different algorithms.



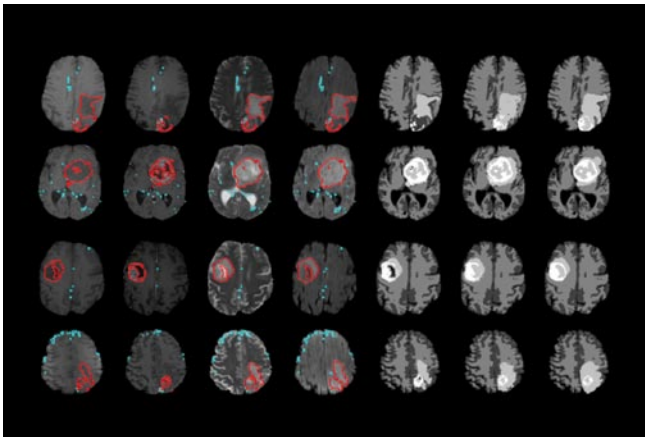

1 | **Segmenting anatomical structures of the brain and brain tumor lesions.** We developed an algorithm that segments automatically normal tissue as well tumor compartments in multimodal MR images of the brain [1]. The algorithm is based on a generative probabilistic model and makes use of physiological prior knowledge.

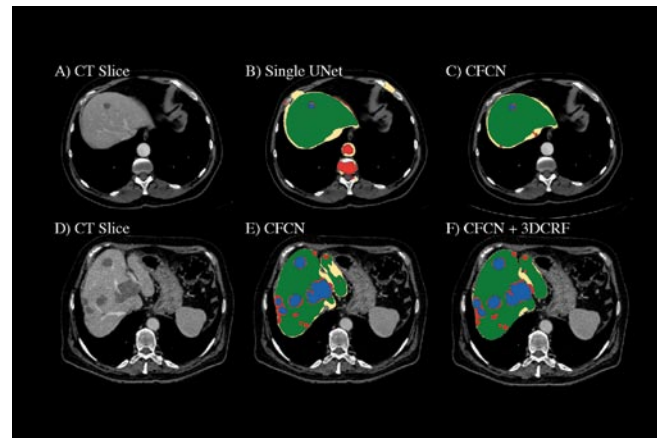

2 | **Automatic tumor volumetry in CT.** We identified optimal machine-learning algorithms for automatically segmenting liver and lesions in CT images of the abdomen. The algorithm we proposed (bottom right) performs best and is based on convolutional neuronal networks trained on a large set of expert annotated image data [4].

### Selected Publications

- [1] B. H. Menze, K. Van Leemput, D. Lashkari, T. Riklin-Raviv, P. Gruber, S. Wegener, M. A. Weber, N. Ayache, and P. Golland, "A generative probabilistic model and discriminative extensions for brain lesion – with application to tumor and stroke," *IEEE Trans. Med. Imag.*, vol. 35, no. 4, pp. 933–946, 2016.
- [2] E. Alberts, M. Rempfler, G. Alber, T. Huber, J. Kirschke, C. Zimmer, and B. H. Menze, "Uncertainty quantification in brain tumor segmentation using CRFs and random perturbation models," in *IEEE 13th International Symposium on Biomedical Imaging*, Prague, Czech Republic, 2016.
- [3] P. A. Gomez, M. Molina-Romero, C. Ulas, G. Bounincontri, J. Sperl, D. K. Jones, M. I. Menzel, and B. H. Menze, "Simultaneous parameter mapping, modality synthesis, and anatomical labeling of the brain with MR fingerprinting," in *Proceedings of MICCAI Workshop on Reconstruction and Analysis of Moving Body Organs*, Athens, Greek, 2016.
- [4] P. Christ, M. Elshaer, F. Ettliger, S. Tatavarty, M. Bickel, P. Bilic, M. Rempfler, M. Armbruster, M. Hofmann, M. D'Anastasi, W. Sommer, A. Ahmadi, and B. H. Menze, "Automatic liver and lesion segmentation in CT using cascaded fully convolutional neural networks and 3D conditional random fields," in *Proceedings of MICCAI Workshop on Reconstruction and Analysis of Moving Body Organs*, Athens, Greek, 2016.

*Publications by this Focus Group can also be found in the section Publications of this report.*

## Focus Group Neuroimaging

Prof. Josef P. Rauschecker (Georgetown University) | Hans Fischer Senior Fellow  
Lukas Utz (TUM) | Doctoral Candidate

Scientific Reports



Josef P. Rauschecker

© Host

Prof. Bernhard Hemmer  
Neurological Clinic and  
Policlinic, TUM

### Energetic costs and directionality of global functional connectivity in the human brain

The main focus of our project is the investigation of signaling-dependent utilization of glucose, the human brain's main source of energy. Despite its small size compared with the rest of the human body, the brain consumes a high amount of energy [1], with a major part of energy used for communication processes. Using the integrated positron emission tomography/magnetic resonance imaging scanner (PET/MRI-scanner) at the university hospital Klinikum rechts der Isar, we simultaneously scanned 22 healthy subjects with [<sup>18</sup>F]fluorodeoxyglucose-positron-emission-tomography (FDG-PET) and functional magnetic resonance imaging (fMRI). This allows for a reliable correlation of the glucose consumption in the neurons through PET, and measures of global functional connectivity i.e., degree centrality (DC), between different brain regions using fMRI.

An analysis of 23 regions from an individual component analysis (ICA) revealed a linear relationship between FDG and DC, with the highest correlation in early sensory and motor regions. In addition to this linear trend, the simultaneously acquired modalities enabled us to generate a novel measure identifying the amount of input signaling to functional brain regions across the human brain. Therefore, we used the biological model that up to 75 percent of signaling-related energy is consumed post-synaptically [2], allowing conclusions about the directionality of the per-se undirected measure of global connectivity. Masking the mean FDG- and DC-data with an atlas from Shirer et al. [3] comprising 14 individual networks, we obtained a global picture of the relationship between the degree of connectivity and signaling input (figure 1). We therefore separated both the mean FDG and mean DC voxel into low / medium / high groups (figure 1a), and calculated the overlap of each network with the respective group (figure 1c – groups of high DC sorted by high FDG). In line with the theory of visual perception, both visual regions (primary and higher) show high levels of connectivity. However, their relative energy consumptions differ, meaning that the majority of voxels in the primary visual area receives signaling input, whereas higher visual areas might act as mediators with a balanced level of input/output communication (figure 1a, 1c). By contrast, the left and right executive control networks (LECN and RECN) consume equally high amounts of energy to support only a few, mainly input connections.

### Effective connectivity in the default mode network is distinctively disrupted in Alzheimer's disease

In 2016, our Focus Group introduced metabolic connectivity mapping (MCM), a new measure of directed or effective connectivity (EC) in the human brain. Applying this voxel measure to simultaneously acquired data from fMRI and FDG-PET scans enabled us to investigate the directionality of functional connectivity in the human brain, and to further identify specific pathways that are disrupted in diseases like Alzheimer's disease (AD). The neuropathological symptoms of AD include an accumulation of misfolded proteins via two possible spreading mechanisms:

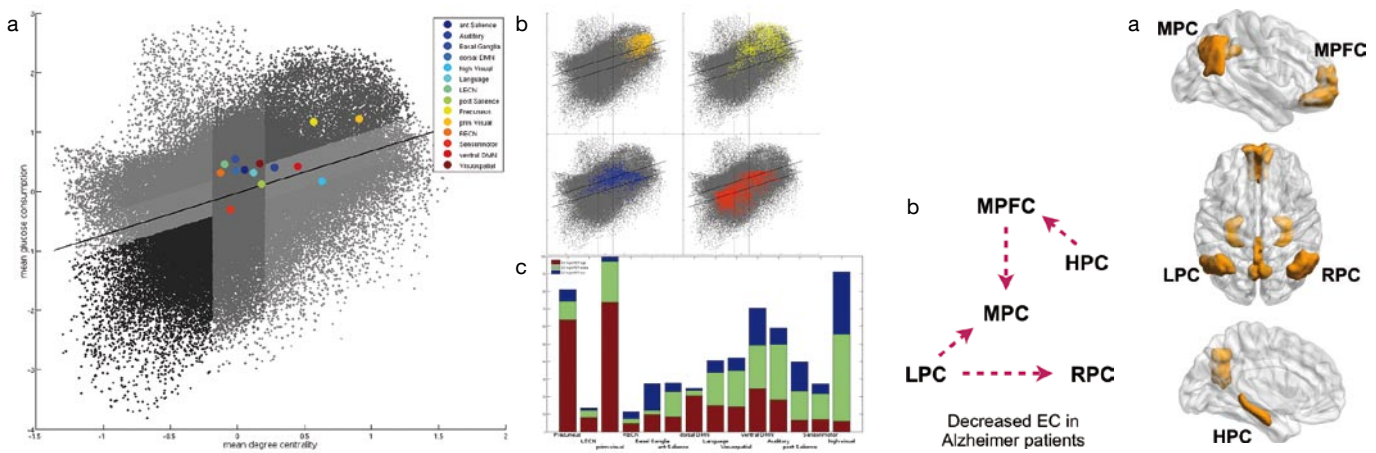

1 | (a) Comparison of mean DC and mean FDG across 22 subjects. Centroids of voxels of 14 networks from Shirer et al. (2012) are shown in colored circles. (b) Exemplary visualization of four networks with varying voxel distributions: prim Visual (left-top), Precuneus (right-top), Auditory (left-bottom) and Sensorimotor (right-bottom). (c) Percentage of overlap with groups of high DC and low/medium/high FDG across all 14 networks. Networks are sorted by the overlap with group of high FDG from left (large overlap) to right (small overlap).

2 | (a) Regions of the default mode network (DMN). MPFC: medial prefrontal cortex, MPC: medial parietal cortex, LPC: left parietal cortex, RPC: right parietal cortex, HPC: bilateral hippocampus. (b) Group difference with reduced EC in the DMN of patients with AD.

(1) downstream from an infected to a naïve neuron; or (2) in an activity-dependent manner, which means that neurons with continuously high activity are most vulnerable to accumulating misfolded disease proteins and, in turn, to progressively affecting upstream neurons. A human brain network known to be affected early in AD is the default mode network (DMN): However, the direction of signaling in this network is still unknown (figure 2a). An analysis of direction of connectivity and contrasts between healthy subjects and patients with AD might therefore provide support for one of these competing theories.

We applied MCM to a dataset of 18 healthy subjects and 35 patients with early AD to contrast the effective connectivity between groups. We then tested whether certain pathways are disrupted in AD. We identified two DMN subsystems: a frontal system including signaling from hippocampus into the medial prefrontal cortex (PFC), and a parietal system with directed signaling into medial parietal cortex (MPC). The only link between these systems is unilateral signaling from medial PFC into MPC. In the patients, we identified a significantly reduced signaling profile from the hippocampus into the medial PFC and subsequently into the MPC (figure 2b), which might be tested with molecular imaging markers and which, in turn, can support one of the two emerging theories about AD.

## References

- [1] D. Clark and L. Sokoloff, "Circulation and energy metabolism of the brain," In *Basic Neurochemistry: Molecular, Cellular and Medical Aspects*, G. J. Siegel, B. W. Agranoff, R. W. Albers, S. K. Fisher, and M. D. Uhler (eds.), Lippincott-Raven, Philadelphia, pp. 637–669, 1999.
- [2] V. Riedel, L. Utz, G. Castrillon, T. Grimmer, J. P. Rauschecker, M. Ploner, K. J. Friston, A. Drzezga, and C. Sorg, "Effective connectivity in the resting human brain," *PNAS* 2015.
- [3] W. R. Shirer, S. Ryali, E. Rykhlevskaia, V. Menon, and M.D. Greicius, "Decoding subject-driven cognitive states with whole-brain connectivity patterns," *Cereb Cortex* 2012.
- [4] M. Scherr, L. Utz, M. Tahmasian, L. Pasquini, M. J. Grothe, J.P. Rauschecker, T. Grimmer, A. Drzezga, C. Sorg, and V. Riedel, "Effective connectivity in the default mode network is distinctively disrupted in Alzheimer's disease," submitted.

*Publications by this Focus Group can also be found in the section Publications of this report.*

## Focus Group **Optimal Control and Medical Imaging**

Prof. Dominique Sugny (University of Bourgogne) | Hans Fischer Fellow  
Quentin Ansel, Wolfgang Kallies, Bálint Koczor (TUM) | Doctoral Candidates

### Scientific Reports



Dominique Sugny

### © Host

Prof. Steffen J. Glaser  
Organic Chemistry, TUM

Our Focus Group is aimed at developing and applying innovative mathematical tools coming from optimal control theory (OCT), with the goal of improving theoretical and experimental techniques in magnetic resonance imaging (MRI), nuclear magnetic resonance (NMR) spectroscopy and quantum information science. This approach allows us to explore and to experimentally reach the physical limits of the corresponding spin dynamics in the presence of typical experimental imperfections and limitations.

Hans Fischer Fellow, Dominique Sugny, made two stays with the TUM-IAS in 2016: The first from January to March, and the second from August to September. During these visits, he and the group pursued a variety of research projects – from looking at something called the “tennis racket effect” to improving MRI scanning of live subjects.

### The tennis racket effect: classical and quantum aspects

In an article set for publication in 2017 in the journal *Physica D* [1], we have proposed a complete theoretical description of the classical tennis racket effect, which occurs in the free rotation of any three-dimensional rigid body. This effect is characterized by a flip of  $\pi$  of the head of the racket when a full rotation of  $2\pi$  around the unstable inertia axis is considered. A schematic description of this motion is given in figure 1. Using the analogy between the Euler and the Bloch equations, we show in [2] that the dynamics of a rigid body plays a fundamental role in the control of two-level quantum systems, and can be used to design specific fields for state-to-state transfers or quantum gate implementations. The quantum analog of the tennis racket effect can also be defined and was demonstrated experimentally using techniques of NMR.

### Contrast optimization for *in vivo* MRIs

Over the previous year, we also investigated the use of optimal control pulses for image contrast optimization [5]. We were able to validate such control sequences for the first time in both *in vitro* and *in vivo* experiments on a small-animal, 4.7T magnetic resonance system. Our results show that these control strategies can be embedded in standard imaging sequences without affecting standard parameters such as slice selection or echo type. They also suggest that the theoretical benefit of optimal control pulses can be transferred to practical MRI acquisitions. As a proof-of-concept, an optimal control contrast pulse has been applied *in vivo* to imaging of an adult female mouse brain. Figure 2 shows the corresponding image. A clear saturation of the brain is achieved (in black), while a significant signal comes from the surrounding parietal muscles. It is also possible to distinguish the cerebrospinal fluid, which appears as a bright spot in the middle of the brain.



1 | The tennis racket effect: Schematic description of the dynamics of a tennis racket.

## Application in quantum computing: implementation of a robust NOT gate

We derived a versatile protocol to implement a fast and robust NOT quantum gate [3], driven by single-shot shaped pulses with appropriate time-dependent phase and intensity profiles. The pulses are derived by combining analytic computations and numerical optimizations. In collaboration with the group of Thomas Halfmann (Technische Universität Darmstadt), we have experimentally demonstrated the applicability, efficiency and robustness of the derived pulses to rephase atomic coherences in a  $\text{Pr}^{3+}:\text{Y}_2\text{SiO}_5$  crystal. This work opens the door to the practical implementation of robust and high-fidelity control procedures with complex target in quantum technology.

*In close collaboration with Michael Tesch, a doctoral candidate working in Steffen Glaser's group at TUM.*

2 | *In vivo* contrast experiment on a mouse brain: Spin echo acquisition with optimal preparation. The experiment has been performed at the Centre de Recherche en Acquisition et Traitement de l'Image pour la Santé (CREATIS Lyon, France).

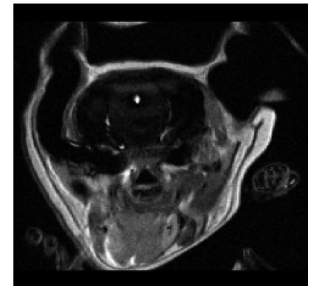

## References

- [1] L. Van Damme, P. Mardesic, and D. Sugny, "The tennis racket effect in a three dimensional rigid body," *Physica D*, vol. 338, no. 1, pp. 17–25, 2017, accepted in 2016.
- [2] L. Van Damme, D. Leiner, P. Mardesic, S. J. Glaser, and D. Sugny, "Linking the rotation of a rigid body to the Schrodinger equation: The quantum tennis racket effect and beyond," submitted to *Sci. Rep.*, 2017.
- [3] L. Van Damme, D. Schraft, G. Genov, D. Sugny, T. Halfmann, and S. Guérin, "Robust NOT-gate by single-shot shaped pulses: Demonstration by rephasing of atomic coherences," submitted to *Phys. Rev. Lett.*, 2017.
- [4] E. Van Reeth, H. Ratiney, M. Tesch, D. Grenier, O. Beuf, S. J. Glaser, and D. Sugny, "Optimal control design of preparation pulses for contrast optimization in MRI," submitted to *J. Magn. Reson.*, 2017.

## Selected publication

- [5] M. Riahi, J. Salomon, S. J. Glaser, and D. Sugny, "Fully efficient time parallelized optimal quantum control algorithm," *Phys. Rev. A*, vol. 94, no. 4, p. 043410, 2016.

*Publications by this Focus Group can also be found in the section Publications of this report.*

# Focus Group Information, Interaction and Mechanism Design

Prof. Dirk Bergemann (Yale University) | Hans Fischer Senior Fellow  
Florian Brandl (TUM) | Doctoral Candidate

## Scientific Reports



Dirk Bergemann

### 📍 Hosts

[Prof. Martin Bichler](#)  
Decision Sciences &  
Systems, TUM,  
[Prof. Felix Brandt](#)  
Algorithmic Game  
Theory, TUM

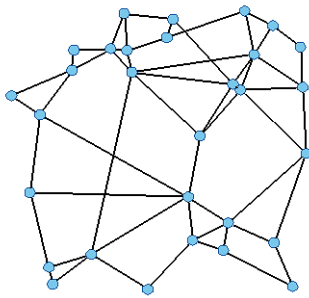

1 | Illustration of a transportation network with nodes being retail loading ramps.

The Focus Group aims at developing new types of models for the design and analysis of economic mechanisms and preference aggregation. The understanding and modeling of markets and economic interactions can be described as the central topic in economics. Rather than modeling markets from a bird's-eye view, *mechanism design* models the incentives of individual decision makers explicitly. A number of recent Nobel Memorial Prizes in economic sciences document the success of this stream of research and this specific way of modeling economic interactions. In recent years, the formal study of mechanism design has found concrete applications in the real world. For example, it has led to market designs in various fields such as spectrum auctions, procurement tenders, and kidney exchanges – cases in which multiple independent decision makers need to be coordinated in a way that ensures the outcome is economically efficient, and that mechanisms are robust to various forms of manipulation.

### Activities

Several activities were initiated in the recent year to foster the collaboration between TUM and Yale University. The German Research Foundation (DFG) recently approved a new graduate program, “Advanced Optimization in the Networked Economy (AdONE),” for which Dirk Bergemann and Martin Bichler serve as principal investigators in a group of scientists from the TUM Departments of Mathematics and Informatics and the TUM School of Management. This graduate program is closely related to the Focus Group.

In particular, the graduate program is running several projects which draw upon mechanism design and optimization. The goal: to develop economic mechanisms which aid economic efficiency in various domains.

As an example, one of the projects explores approximation mechanisms for coordination problems in retail logistics. Carriers in retail logistics often face congestion at warehouses at certain times of the day, which forces them to wait before their trucks can be unloaded. These waiting times are caused by a lack of coordination among carriers in their vehicle routing and planning decisions. Depending on the topology of the transportation network, waiting times can arise at different loading ramps or nodes of the network (figure 1). According to a survey among more than 500 transport companies, 18 percent of them have an average waiting time of more than two hours, and 51 percent have an average waiting time between one and two hours at each warehouse. This has a significant negative impact on logistics efficiency.

2 | Illustration of an approximation mechanism based on the linear programming relaxation of the allocation problem.

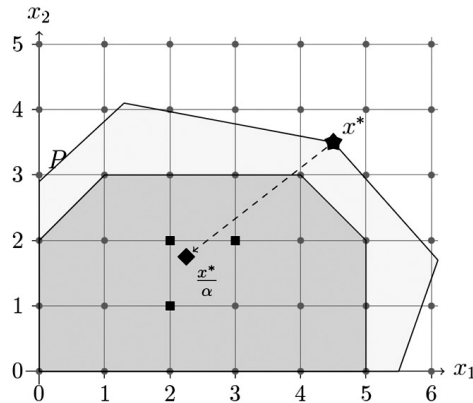

We develop approximation mechanisms tailored to the requirements in retail logistics, which address computational complexity and strategic complexity of the underlying coordination problem. One approach relies on the linear programming relaxation of the integer linear program assigning tours to carriers. The relaxed solution is scaled down, and feasible integer solutions are sampled using an approxima-

tion algorithm (figure 2). Numerical experiments yield initial insights in the efficiency gains of such mechanisms and the results suggest that the waiting times of carriers can be reduced substantially via coordination mechanisms.

### Visits and talks

To facilitate collaboration within the Focus Group, we organized two visits by TUM faculty to Yale University. Martin Bichler and Florian Brandl visited Yale in summer 2016, giving talks and collaborating on site with Dirk Bergemann. In August, Martin Bichler spent his time at Yale University working on problems in mechanism design. Florian Brandl, a doctoral candidate of Felix Brandt, visited the Microeconomic Theory Group at Yale University from August to October 2016, hosted by Dirk Bergemann. Numerous talks and discussions with students, academic staff, visitors, and, in particular, Dirk Bergemann, produced proficient feedback for ongoing research and new ideas for future projects. The research conducted during this time focused on a fundamental problem in collective decision making: how to aggregate the preferences of a group of agents into a collective preference? Arrow's famous impossibility theorem – named after economist Kenneth Arrow – shows that every method that aggregates preferences has serious drawbacks. We examined this problem for the case when the agents' preferences admit a particular structure. Preliminary results suggest that this allows for more positive results.

### Selected Publications

- [1] D. Bergemann and S. Morris, "Bayes Correlated Equilibrium and the Comparison of Information Structures in Games," *Theor. Econ.*, vol. 11, no. 2, pp. 487–522, 2016.
- [2] M. Bichler, Z. Hao, and G. Adomavicius, "Coalition-based pricing in ascending combinatorial auctions," *Inf. Syst. Res.*, article in advance, published online Jan. 12, 2017, accepted in 2016.
- [3] F. Brandl, F. Brandt, and H. G. Seedig, "Consistent probabilistic social choice," *Econometrica*, vol. 84, no. 5, pp. 1839–1880, 2016.

*Publications by this Focus Group can also be found in the section Publications of this report.*

# Focus Group Exploiting Antenna Arrays for Next-Generation Wireless Communications Systems

Prof. A. Lee Swindlehurst (University of California, Irvine) | Hans Fischer Senior Fellow  
Fabian Steiner, Hela Jedda (TUM) | Doctoral Candidates

Scientific Reports



A. Lee Swindlehurst

© Hosts

Prof. Josef A. Nosseck,  
Prof. Wolfgang Utschick  
Signal Processing  
Methods, TUM

## Coarsely quantized massive MIMO communication systems

Massive multiple-input multiple-output (MIMO) technology is considered to be a key component for 5G wireless communications systems, and has recently attracted considerable research interest. The main characteristic of massive MIMO is a base station (BS) array equipped with many (perhaps a hundred or more) antennas, as depicted in figure 1, which provides unprecedented spatial degrees of freedom for simultaneously serving multiple user terminals at the same time and on the same frequency channel. It has been shown that, with channel state information (CSI) available at the BS, relatively simple signal processing techniques such as maximum-ratio combining (MRC) or zero-forcing (ZF) can be employed at the BS to reduce the noise and interference at the terminals. This could lead to improvements not only in spectral efficiency, but in energy efficiency as well [1]–[5].

In most work on massive MIMO, perfect hardware implementations with infinite resolution analog-to-digital converters (ADCs) are assumed. There has been limited prior work on the impact of non-ideal hardware on massive MIMO systems including [6]–[8], which studied imperfections such as phase drifts and additive distortion and showed that a massive number of antennas can mitigate these effects. In terms of hardware, perhaps the most important issue at the BS for massive MIMO is the power consumption of the ADCs, which grows exponentially with the number of quantization bits [9], and also grows with increased bandwidth and sampling rate requirements, as proposed in next generation systems. For example, commercially available ADCs with resolutions of 12 to 16 bits consume on the order of several watts [10]. For massive MIMO configurations employing large antenna arrays and many ADCs, the cost and power consumption will be prohibitive, and alternative approaches are needed.

The use of low-resolution (one to three bits) ADCs is a potential solution to this problem. Our Focus Group has continued to study the case of simple one-bit ADCs, which consist of a simple comparator and consume negligible power (a few milliwatts). One-bit ADCs do not require automatic gain control and linear amplifiers: the corresponding radio frequency (RF) chains can therefore be implemented with very low cost and power consumption. It was shown in [11] that MIMO capacity is not severely reduced by the coarse quantization at low signal-to-noise ratios (SNRs); in particular, the power penalty due to one-bit quantization is approximately equal to only about 2dB in the low SNR region. On the other hand, at high SNRs one-bit quantization can produce a large capacity loss, but there is reason to believe that massive MIMO systems will operate at relatively low SNRs for improved energy efficiency, exploiting array gain to overcome the resulting distortion. This will be especially true as systems move to higher (e.g., millimeter wave) frequencies. In either case, the availability of accurate BS-side CSI is indispensable for exploiting the full potential of a massive MIMO system, and an important open question is how to reliably estimate the channel and decode the data symbols under one-bit output quantization.



Our work over the past year has focused on the communications “uplink,” the case depicted in figure 1, in which several single-antenna users transmit signals to the multiple-antenna BS. A summary of our accomplishments on the use of one-bit ADCs for the massive MIMO uplink is given below:

- We derived the Cramer-Rao lower bound (CRLB) for unbiased channel estimators, and showed that the performance of any unbiased channel estimator with one-bit quantization actually degrades as SNR increases.
- We used the Bussgang decomposition [12] to reformulate the nonlinear quantizer operation as a statistically equivalent linear system. Contrary to previous work, we performed the Bussgang decomposition separately for the pilot and data phase as well as for each channel realization. We derived a biased estimator approach we refer to as Bussgang Linear Minimum Mean Squared Error (BLMMSE) channel estimator. We calculated the high-SNR channel estimation error floor achieved by the proposed estimator, and showed via simulation that the BLMMSE approach outperforms previously proposed methods.
- We quantified an approximation of the theoretical rate achievable in the uplink using MRC or ZF receivers based on the BLMMSE channel estimate, and we obtained a simple but tight closed-form approximation on the uplink rate at low SNR that accurately approximates our empirical observations. Similar work has relied on a simpler additive quantization noise model to approximate the rate, but it assumed perfect rather than estimated CSI is available at the BS, which leads to an overly optimistic assessment.
- Using the closed-form expression for the achievable rate, we analyzed the power efficiency of massive MIMO with one-bit ADCs and showed that similar efficiency is obtained as in conventional massive MIMO systems. In particular, assuming  $M$  antennas, we show overall system performance remains unchanged if (1) for a fixed level of CSI accuracy (training data power independent of  $M$ ), the transmit power of each user terminal is reduced proportionally to  $1/M$ , and (2) power during both training and data transmissions is reduced proportionally to  $1/\sqrt{M}$ .
- We proposed an optimal resource allocation scheme to maximize the sum spectral efficiency of a one-bit massive MIMO system under a total power constraint. Numerical results indicate that the optimal training length in one-bit systems is no longer always equal to the number of users and the proposed resource allocation scheme notably improves performance compared to the case without power allocation.
- We showed that to achieve similar performance, a one-bit massive MIMO system employing an MRC receiver will require approximately 2.2 to 2.3 times more antennas than a conventional system if the sum spectral efficiency for both systems is optimized by employing our optimal resource allocation scheme; for the ZF receiver, we showed that to achieve the same goal, increasingly more antennas are needed as average transmit power increases. This result is depicted in figure 2, which shows the required ratio of the number of antennas as a function of the average transmit power. Note that at low SNRs, the factor of 2.2 to 2.3 also applies to the ZF receiver.

Scientific Reports  
Exploiting Antenna Arrays for Next-Generation  
Wireless Communications Systems

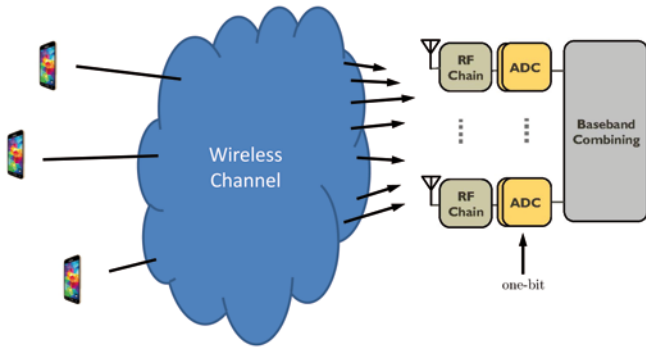

1 | Typical massive MIMO scenario: a number of users with single antenna mobile devices communicate with a base station that possesses a large antenna array of antennas. After the signals are received by the antennas, they are digitized by ADCs before being combined in the baseband.

Probabilistically shaped constellations  
for high-speed wireless

Our research collaboration with colleagues from the TUM Institute for Communications Engineering, Georg Böcherer and Patrick Schulte, earned us third place in the renowned 2015 Bell Labs Prize. As a follow up to this success, we have continued to place a special emphasis on showing practical applicability of our results. For this purpose, we teamed up with Nokia Bell Labs in Stuttgart as well as Deutsche Telekom to show that the ideas we've developed also work in a practical field trial using an optical fiber network owned and operated by Deutsche Telekom [13]. In the corresponding experiment, it was shown that data can be transmitted reliably at an unprecedented throughput of one Terabit/s in a so-called super channel experiment, where a major enabler was the probabilistic shaping scheme. The results were presented in a paper at the European Conference on Optical Communications (ECOC) in Düsseldorf [22]. The paper received broad media coverage, and was even featured in the German news magazine, Stern [14]. In a second experiment, it was also shown that probabilistic shaping improves the throughput in long-haul optical transmissions for transoceanic cable systems [15]. For the year ahead, we plan to extend our research on fast, parallelizable distribution matching and channel coding algorithms for industrial applications.

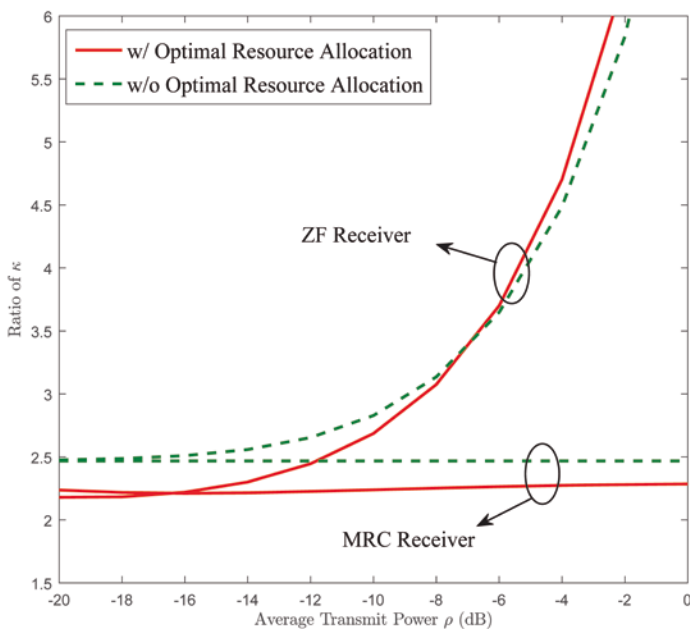

2 | Ratio of the number of extra antennas a one-bit system will require compared with a full-resolution system in order to achieve the same sum-rate performance for a case with 128 antennas and eight users.

## References

- [1] T. Marzetta, "Non-cooperative cellular wireless with unlimited numbers of base station antennas," *IEEE Transactions on Wireless Communications*, vol. 9, no. 11, pp. 3590–3600, November 2010.
- [2] H. Q. Ngo, E. Larsson, and T. Marzetta, "Energy and spectral efficiency of very large multiuser MIMO systems," *IEEE Transactions on Communications*, vol. 61, no. 4, pp. 1436–1449, April 2013.
- [3] E. Larsson, O. Edfors, F. Tufvesson, and T. Marzetta, "Massive MIMO for next generation wireless systems," *IEEE Communications Magazine*, vol. 52, no. 2, pp. 186–195, February 2014.
- [4] F. Rusek, D. Persson, B. K. Lau, E. Larsson, T. Marzetta, O. Edfors, and F. Tufvesson, "Scaling up MIMO: Opportunities and challenges with very large arrays," *IEEE Signal Processing Magazine*, vol. 30, no. 1, pp. 40–60, Jan 2013.
- [5] L. Lu, G. Y. Li, A. L. Swindlehurst, A. Ashikhmin, and R. Zhang, "An overview of massive MIMO: Benefits and challenges," *IEEE Journal of Selected Topics in Signal Processing*, vol. 8, no. 5, pp. 742–758, 2014.
- [6] E. Bjornson, J. Hoydis, M. Kountouris, and M. Debbah, "Massive MIMO systems with non-ideal hardware: Energy efficiency, estimation, and capacity limits," *IEEE Transactions on Information Theory*, vol. 60, no. 11, pp. 7112–7139, Nov 2014.
- [7] E. Bjornson, M. Matthaiou, and M. Debbah, "Massive MIMO with nonideal arbitrary arrays: Hardware scaling laws and circuit-aware design," *IEEE Transactions on Wireless Communications*, vol. 14, no. 8, pp. 4353–4368, Aug 2015.
- [8] X. Zhang, M. Matthaiou, M. Coldrey, and E. Bjornson, "Impact of residual transmit RF impairments on training-based MIMO systems," *IEEE Transactions on Communications*, vol. 63, no. 8, pp. 2899–2911, Aug 2015.
- [9] R. Walden, "Analog-to-digital converter survey and analysis," *IEEE Journal on Selected Areas in Communications*, vol. 17, no. 4, pp. 539–550, Apr 1999.
- [10] "Texas instruments ADC products." Available at: <http://www.ti.com/lscs/ti/data-converters/analog-to-digital-converter-products.page>
- [11] A. Mezghani and J. Nosseck, "Analysis of Rayleigh-fading channels with 1-bit quantized output," in *IEEE International Symposium on Information Theory (ISIT)*, July 2008, pp. 260–264.
- [12] J. J. Bussgang, "Crosscorrelation functions of amplitude-distorted Gaussian signals," *MIT Research Lab. Electronics, Tech. Rep. 216*, 1952.
- [13] <https://www.tum.de/en/about-tum/news/press-releases/detail/article/33398/>
- [14] <http://www.stern.de/digital/online/nokia-und-telekom-testen-das-superinternet---mit-1-terabit-die-sekunde-7069712.html>
- [15] [http://www.nokia.com/en\\_int/news/releases/2016/10/12/alcatel-lucent-submarine-networks-and-nokia-bell-labs-achieve-65-terabit-per-second-transmission-record-for-transoceanic-cable-systems](http://www.nokia.com/en_int/news/releases/2016/10/12/alcatel-lucent-submarine-networks-and-nokia-bell-labs-achieve-65-terabit-per-second-transmission-record-for-transoceanic-cable-systems)

## Selected Publications

- [16] A. K. Saxena, I. Fijalkow and A. Swindlehurst, "On one-bit quantized ZF precoding for the multiuser massive MIMO downlink," 2016 *IEEE Sensor Array and Multichannel Signal Processing Workshop (SAM)*, Rio de Janeiro, Brazil, 2016.
- [17] Y. Li, C. Tao, L. Liu, G. Seco-Granados and A. Swindlehurst, "Channel estimation and uplink achievable rates in one-bit massive MIMO systems," 2016 *IEEE Sensor Array and Multichannel Signal Processing Workshop (SAM)*, Rio de Janeiro, Brazil, 2016.
- [18] L. You, X. Gao, A. Swindlehurst and W. Zhong, "Channel Acquisition for Massive MIMO-OFDM With Adjustable Phase Shift Pilots," in *IEEE Transactions on Signal Processing*, vol. 64, no. 6, pp. 1461–1476, March, 2016.
- [19] F. Steiner, A. Mezghani, A. Swindlehurst, J. A. Nosseck and W. Utschick, "Turbo-Like Joint Data-and-Channel Estimation in Quantized Massive MIMO Systems," 20th *International ITG Workshop on Smart Antennas (WSA)*, Munich, Germany, 2016.
- [20] O. B. Usman, H. Jedda, A. Mezghani and J. A. Nosseck, "MMSE precoder for massive MIMO using 1-bit quantization," 2016 *IEEE International Conference on Acoustics, Speech and Signal Processing (ICASSP)*, Shanghai, 2016, pp. 3381–3385.
- [21] H. Jedda, J. A. Nosseck and A. Mezghani, "Minimum BER precoding in 1-Bit massive MIMO systems," 2016 *IEEE Sensor Array and Multichannel Signal Processing Workshop (SAM)*, Rio de Janeiro, Brazil, 2016.
- [22] W. Idler, F. Buchali, L. Schmalen, E. Lach, R.-P. Braun, G. Böcherer, P. Schulte, and F. Steiner, "Field demonstration of 1Tbit/s super-channel network using probabilistically shaped constellations," in *European Conference on Optical Communication (ECOC)*, Düsseldorf, Germany, Sep. 2016, paper M.1.D.2.

*Publications by this Focus Group can also be found in the section Publications of this report.*

# Focus Group Networked Cyber-Physical Systems

Prof. John S. Baras (University of Maryland) | Hans Fischer Senior Fellow  
Touraj Soleymani (TUM) | Doctoral Candidate

## Scientific Reports



John S. Baras

### © Host

Prof. Sandra Hirche  
Information-Oriented  
Control, TUM

The Focus Group on Networked Cyber-Physical Systems (Net-CPS) was established in October 2014 by Hans Fischer Senior Fellow John S. Baras and Sandra Hirche, together with doctoral candidate, Touraj Soleymani. Research was initiated to tackle the important topic of “Value of Information.” The purpose of the research undertaken by the group is to foster the development of fundamental principles for the design, manufacturing and operation of cyber-physical systems (CPS), which collaborate under various networking arrangements and constraints. CPS are technological systems in which both physical and cyber components are tightly integrated (see figure 1). Examples abound, ranging from smartphones and smart sensors, homes, cars, power grids and manufacturing to integrated transportation systems, human-robot teams and many others. Most of modern CPS are actually networked, typically via the internet or the cloud, or via special logical or physical networks. Examples include modern factories and enterprises, heterogeneous wireless networks and wireless sensor networks, social networks over the internet, the Industrial Internet Consortium (IIC) and the Internet of Things (IoT). When networks are under consideration, new fundamental challenges emerge as the network semantics and characteristics must be modeled and taken into account. The group’s research is focused on addressing fundamental challenges on two fronts: (a) the interface between the cyber and physical components and their joint design and performance evaluation; (b) the implications of the networked interfaces and the collaborative aspects of these systems and their design and performance evaluation. An additional challenge that has emerged in the last few years, also addressed by the Net-CPS Focus Group, is the incorporation of humans – ubiquitous elements of such networked CPS – as system “components” from the start of the analysis and performance evaluation.

We believe a key to improving our understanding about these systems is something we term the “Value of Information.” Two main information-theoretic measures of information for a pair of stochastic processes are “mutual information” by Shannon sampling series and “directed information” as defined by James Massey. In fact, directed information, a definition which first appeared in the context of feedback communication, is a generalization of mutual information in which the causality condition is considered. Nonetheless, the above measures fail to show the difference between important and unimportant events with similar distributions. In other words, they quantify only the amount of reduction in the uncertainty of the recipient about a stochastic process in the environment given the side information – regardless of its application. This issue has driven the Focus Group’s interest in investigating a new measure of information that takes into account operational and economic aspects of information. This value of information should quantify the improvement in the future expenditure of the system given the causal side information.

Based on the idea of the value of information, the group is targeting the design of a mechanism that transmits only important measurements from the plant to the controller in a networked control system (see figure 2; [1], [2], [3], [4]). In this year, in [4] we showed that for the estimation problem of a linear system, the optimal sampling policy – without presuming a priori any structure – samples a measurement whenever the value of information exceeds a threshold.

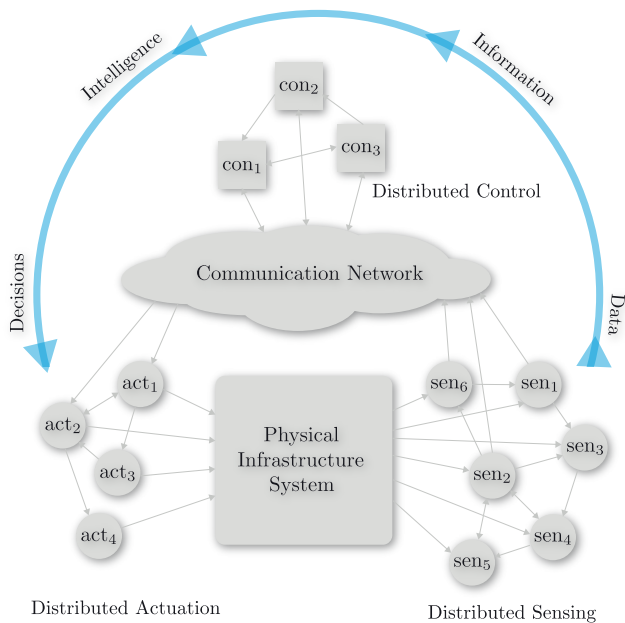

1 | A schematic view of a networked cyber-physical system.

This work connects the value of information to event-driven sampling, and is in accordance with the idea of using the value of information for optimal information acquisition. Recently, in an ongoing study we sought fundamental limitations in control of mobile cyber-physical systems. We developed a framework for partially observable linear quadratic Gaussian (LQG) control over communication networks in which the forward channel transporting measurements is modeled by a zero-delay lossy channel, and the feedback channel transporting control inputs is assumed ideal. Following the rate-distortion tradeoff for control under communication constraints we studied minimum-rate LQG control with optimal event-driven sampling. Making use of dynamic programming, we characterized the optimal control and the optimal sampling policies that achieve the minimum data rate required for a guaranteed level of control performance. In particular, we proved that in the presence of event-driven sampling the adopted filter is optimal and the separation principle between control and estimation holds. We showed that the optimal control policy is a “certainty equivalent” policy and the optimal sampling policy is a “threshold” policy expressed in terms of the value of information.

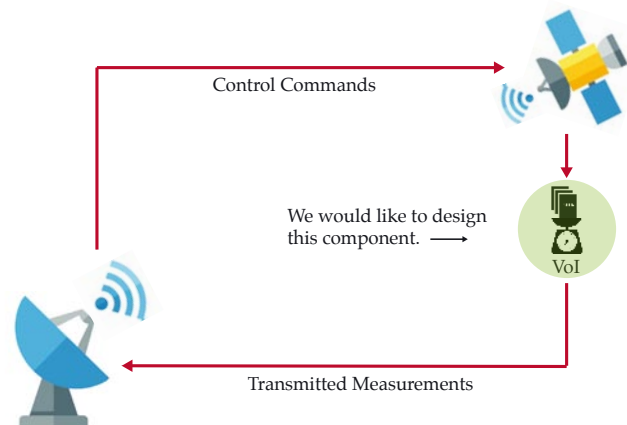

2 | Event-triggered sampling in a networked control system.

The Focus Group also successfully organized a major event at TUM-IAS, the first “International Symposium on Networked Cyber-Physical Systems (Net-CPS 2016),” which took place on September 19–20, 2016. The objective of the symposium was to provide a forum for presenting state-of-the-art work and describe challenges in this emerging and critical area. Internationally renowned experts shared their insights during three plenary lectures, 12 lectures, two panel sessions and two poster sessions. More than 90 researchers from Germany and abroad participated in the event. More information about the event can be found on pages 28–29 and at [www.ias.tum.de/events/netcps2016](http://www.ias.tum.de/events/netcps2016).

#### Selected Publications

- [1] T. Soleymani, S. Hirche, and J. S. Baras, “Optimal stationary self-triggered sampling for estimation,” in Proceedings of the IEEE Conference on Decision and Control (CDC), Las Vegas, USA, 2016.
- [2] T. Soleymani, S. Hirche, and J. S. Baras, “Optimal self-driven sampling for estimation based on value of information,” in Proceedings of the IEEE International Workshop on Discrete Event Systems (WODES), Xi’an, China, 2016.
- [3] T. Soleymani, S. Hirche, and J. S. Baras, “Maximization of information in energy-limited directed communication,” in Proceedings of the European Control Conference (ECC), Aalborg, Denmark, 2016.
- [4] T. Soleymani, S. Hirche, and J. S. Baras, “Optimal information control in cyber-physical systems,” in Proceedings of the IFAC Workshop on Distributed Estimation and Control in Networked Systems (NecSys), Tokyo, Japan, 2016.

*Publications by this Focus Group can also be found in the section Publications of this report.*

## Scientific Reports



Martin Buss

### Host

Automatic Control Engineering, TUM

### Alumni Members

[Prof. Dongheui Lee \(TUM\)](#) | Carl von Linde Junior Fellow  
[Sang-Ik An \(TUM\)](#) | Doctoral Candidate

## Seamless human-robot interaction in dynamic environments

At present, the acceptance of robots beyond the group of technical experts is rising, and the general public is slowly starting to accept and respect robots as helpful servants in daily life – both at home and work. Nevertheless, a robotic servant is currently “only” expected to fulfill its assigned task reliably and without harming or disturbing the human user. The next logical step is to make robots acceptable not merely as servants, but as collaborators in human-robot environments. A robot collaborator would need to have the ability to consider multiple acceptance levels and needs in order to infer the intentions of a human partner. At the same time, complexity from the user’s perspective must not increase in order to keep the group of potential users large. Within the ERC Advanced Grant SHRINE, our group developed cooperative manipulation skills in robots – skills which imitate human manipulation and cooperation behavior and which do not require expert knowledge during task execution.

When multiple humans cooperate to solve a physical task, they utilize many channels of communication: visual and physical interaction (haptics) are the most important. The communication channels which can be used for human-robot interaction depend highly upon the particular cooperative task that is being performed. Cooperative assembly, for example, may try to avoid physical contact between human and machine, whereas in a cooperative transport scenario, both visual and haptic communication are available. In the latter case, the two communication channels are not equally important, which is the case in many other physical cooperation scenarios as well. Haptic communication is superior to visual communication in terms of processing time, precision and information quality. Properly exploited, the haptic communication channel alone can even be sufficient to enable seamless human-robot cooperation.

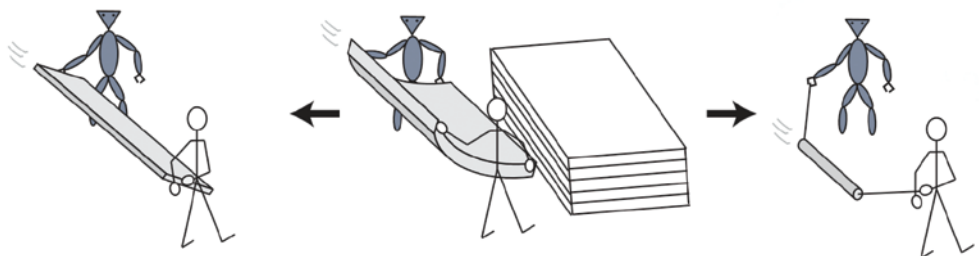

1 | Cooperative flexible object swinging (center) consists of two fundamental dynamics: rigid object swinging (left) and pendulum swinging (right).

These observations were demonstrated with an exemplary human-robot cooperative dynamic manipulation scenario. In this scenario, complex, pendulum-like objects were cooperatively swung up to a target height, at which they could be released to be placed at a desired elevated location. Leader and follower roles evolved based on available knowledge of the desired object energy, for example, height. Without using visual feedback from a camera system, a standard robotic arm was able to cooperatively swing a pendulum-like object with every visitor in our lab.

By projecting the measured interaction forces onto an abstract simple pendulum, the robot separates desired from undesired oscillations. An energy-based controller excites the desired oscillation at its natural frequency, while undesired oscillations can be damped simultaneously. If the target energy of the desired oscillation is unknown to the robot, the robot infers the human intent by monitoring and imitating the human's energy flow.

*This work was conducted in cooperation with Philine Donner and Markus Schill (Automatic Control Engineering, TUM).*

#### Selected Publications

- [1] P. Donner and M. Buss, "Cooperative Swinging of Complex Pendulum-Like Objects: Experimental Evaluation," *IEEE Transactions on Robotics*, vol. 32, no. 3, pp. 744–753, 2016.
- A. Turnwald, D. Althoff, D. Wollherr, and M. Buss, "Understanding Human Avoidance Behavior: Interaction-aware Decision Making based on Game Theory," *International Journal of Social Robotics*, vol. 8, no. 2, pp. 331–351, 2016.

*Publications by this Focus Group can also be found in the section Publications of this report.*

# Focus Group Automated Controller Synthesis

Prof. Anca Muscholl (LaBRI, University of Bordeaux) | Hans Fischer Senior Fellow  
Dr. Denis Kuperberg (TUM) | Postdoctoral Researcher

Scientific Reports



Anca Muscholl

© Hosts

Prof. Samarjit

Chakraborty

Institute of Real-Time  
Computer Systems,  
TUM

Prof. Javier Esparza

Foundations of Software  
Reliability and Theoretic-  
al Computer Science,  
TUM

## Controller synthesis: from models to implementations

Cars, planes, power grids, manufacturing plants, robots, and many other systems are increasingly controlled by software – and these complex controlled systems require formal certification. The Focus Group Automated Controller Synthesis concentrates its research on the development of algorithmic techniques for the design and validation of these complex controlled systems. Controller synthesis techniques produce correct-by-construction solutions that do not require intensive, post-factum testing or verification. They offer a promising approach to addressing the growing complexity and time-to-market pressures present in a wide range of industries and technologies.

Modern, complex systems often rely on communication over a network connecting spatially distributed devices (controlled networked systems, figure 1). As an example, contemporary automotive in-vehicle architectures consist of up to 100 electronic control units, sensors, controllers and actuators connected via shared buses. The current state-of-the-art of the design of these networks is based on a number of abstractions or idealistic assumptions about the implementation platform for the controllers. These include the availability of infinite arithmetic precision, zero computation and communication delays and no deadline misses. As a result, control performance that is obtained at the controller design phase significantly deviates after the mathematical models of the designed controllers are implemented on a hardware architecture. This so-called semantic gap between controller models and their implementations gives rise to the need for intensive testing and debugging, which currently dominates the design cost in many application domains. Further, since the testing, debugging and iterative design processes are often ad hoc in nature, this makes certification very time consuming. Our first efforts show that by co-designing control algorithms and the platform architectures on which these algorithms are to be implemented, a lot of testing and debugging can be avoided [1].

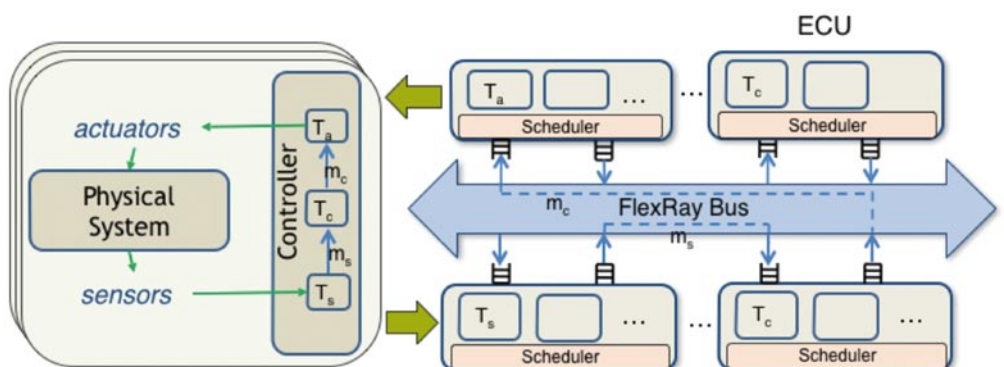

1 | FlexRay-based control system.

Our general goal is to develop algorithmic techniques for a joint design and verification of controllers and their implementation infrastructure, taking into account quantitative characteristics of the computation/communication architecture.



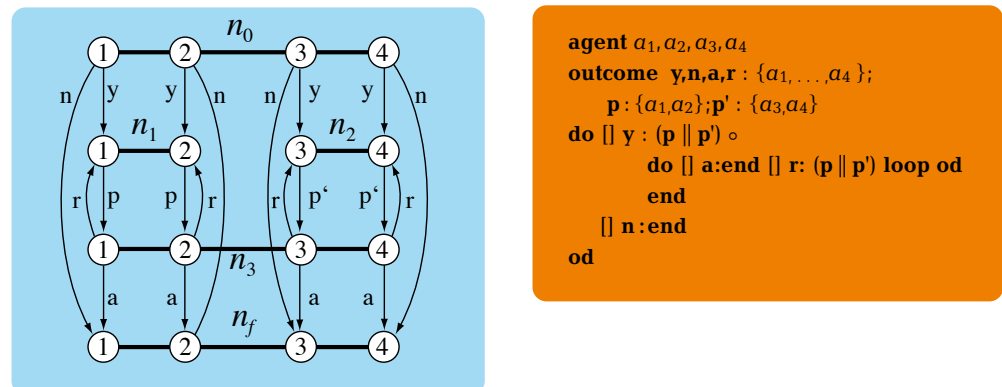

2 | A negotiation diagram and its equivalent, automatically generated distributed program.

In [1] we proposed a co-optimization approach for FlexRay-based distributed control systems that synthesizes both the controllers and the task and communication schedules. Compared with existing methods, this approach is more scalable and allows multi-objective optimization – taking into account both the overall control performance and the bus resource utilization. The certification of performant software such as distributed controllers is a significant endeavor. This kind of software is particularly fault-prone, because faults may happen under very specific schedules of various components. Since the likelihood of exploring such corner case schedules during regular testing is very low, automated safety check and controller synthesis are a major concern. Our long-term objective is to develop scalable algorithms for building distributed monitors and controllers that guarantee fault-tolerance. One step we have taken towards achieving this goal: We have explored algorithmic verification techniques for negotiation diagrams, a novel model of distributed computation (figure 2). Negotiation diagrams use an interaction primitive combining synchronization and nondeterministic choice. They turned out to be surprisingly manageable for algorithmic verification [2], and our results suggest that they may be a promising synchronization model for realizing scalable algorithms for safety check and controller synthesis. In a second line of research, we progressed on automated verification techniques for parametrized dynamic concurrent programs. Parametrized verification techniques guarantee that a given property, for example, safety, holds independent of the number of components in any given system. Our results show that safety can be checked even for computationally powerful components that can create recursively further components.

### Selected Publications

- [1] D. Roy, L. Zhang, W. Chang, D. Goswami, and S. Chakraborty, “Multi-objective co-optimization of FlexRay-based distributed control systems,” in 22nd IEEE Real-time and embedded technology and applications symposium, RTAS, Vienna, Austria, 2016, pp. 279–290.
- [2] J. Esparza, D. Kuperberg, A. Muscholl, and I. Walukiewicz, “Soundness in negotiations,” in 27th International Conference on Concurrency Theory, Québec, Canada, 2016, no. 12, pp. 1–13.

*Publications by this Focus Group can also be found in the section Publications of this report.*

# Focus Group **Safe Adaptive Dependable Aerospace Systems (SADAS)**

Dr. Matthias Heller (Airbus Defence and Space) | Rudolf Diesel Industry Fellow  
Prof. Gernot Spiegelberg (Siemens AG) | Rudolf Diesel Industry Fellow  
Prof. Klaus Schilling (University of Würzburg) | Visiting Fellow

## Scientific Reports



Matthias Heller



Gernot Spiegelberg

## © Host

[Prof. Florian Holzzapfel](#)  
Flight System Dynamics,  
TUM

## Safe Adaptive Dependable Aerospace Systems (SADAS): “Flying into a *novel* Future”

For the TUM-IAS Focus Group Safe Adaptive Dependable Aerospace Systems (SADAS), our main objective is the investigation of innovative techniques that can provide safe, highly reliable and affordable automation for aerospace systems. At this juncture, we are taking the research results from previous IAS Focus Groups “Aircraft Stability and Control” and “Diesel Reloaded” with the target of using them to advance the science. The goal: working towards a novel common approach for future aerospace, vehicle and respective multi-vehicle systems featuring the “Bi-directional Transfer of Concepts: From aerospace systems to vehicle systems – and back.”

In aerospace applications, alongside the control and mastery of challenging systems dynamics, compliance with safety requirements and regulations is mandatory. Promising new results from control theory research – together with progress being made in automation technology – may offer highly attractive approaches and solutions for the development of viable, robust and reconfigurable unmanned aerial vehicle systems (UAS). Nevertheless, due to the specific requirements and general framework conditions in the aerospace environment – in particular the totally unresolved certification problem – the advancement of these new methods for real-world applications or even entry to market has to be mastered. Although initial technology demonstrators are available for testing, there is still a significant amount of research to be performed if we want to realize safe, highly reliable and affordable systems – ones which also satisfy the strict, mandatory regulations and certification requirements imposed upon the transportation- and especially the aerospace-industries.

It is therefore our vision and mission statement to fully develop and mature novel control approaches (e.g., those featuring adaptive stabilization and flight envelope protection along with reconfiguration methods) towards their valuable application within real flying systems by overcoming the so-called “certification collapse.” This means we are aiming to develop certifiable “autoflight” systems featuring guaranteed stability, robustness and performance properties which comply with the rigid requirements for safety, accuracy, availability and survivability that are common in the aviation sector. Our research integrates the different – albeit complementary – fields of competence in mechanical engineering, aerodynamics, flight system dynamics, control and embedded computers. Our target is the development of innovative technologies and solutions for aerospace systems that bridge the gap between theory and real flight applications.



1 | SAGITTA multidisciplinary advanced research demonstrator – Flying Wing UAV.

## Major activities and achievements in 2016

Over the past year, the SADAS group focused on finalizing development, integration and testing efforts in preparation for the SAGITTA demonstrator's first flight – a mission that is scheduled for early summer 2017 at the Overberg Test Range, South Africa.

The SAGITTA demonstrator is a diamond-shaped, flying wing-type unmanned aerial vehicle (UAV) with a weight of about 145 kg (figure 1). It was developed under the auspices of Airbus Defence and Space's "Open Innovation Pilot Program SAGITTA" together with a broad range of high-profile academic partners. The project embodies our vision and strategy for proving the evidence of validity and feasibility of the novel approaches, research results and technologies via in-flight demonstration. The former TUM-IAS Focus Group, Aircraft Stability and Control (and now the successor group, SADAS) – led by TUM-IAS Rudolf Diesel Industry Fellow, Matthias Heller – holds the overall design responsibility for the absolutely vital and safety-critical flight management system (FMS). The FMS is comprised of the Autoflight and Automatic Take-off and Landing (ATOL) system.

A major achievement over the past year has been the delivery of the initial "on-ground controller and taxi-test software" in the spring of 2016. This facilitated the first manual and automatic (self-driving) taxi tests at Manching Airfield (near Munich) – at velocities of up to 65 knots groundspeed between spring and late autumn 2016 (figure 2). The next decisive step was a series of systematic (high/low speed) automatic taxi tests with different predetermined gain schedule settings. The goal: To verify and increase the demonstrator's ground controller performance, which in turn allowed us to finalize its layout and design. Together with the completion of autoflight and ATOL functionalities, this culminated in the crucial delivery and formal handover of the final first flight FMS software flashed on the flight control computer (FCC) in December 2016.

After the demonstrator successfully completes the test readiness review (TRR), final formal tests will need to be performed: these are targeted for finalization in spring 2017. Subsequently, once the SAGITTA demonstrator has successfully passed the final hurdle in terms of the flight readiness review, we will prepare it for shipment to the Overberg test range in South Africa. At the time of publication, the SAGITTA's first flight mission was scheduled for May 2017: If successful, the SAGITTA will have demonstrated our vision for soaring – unmanned – and autonomously into a novel future.

Concerning space applications: Increases in robustness could be achieved through the inclusion of cooperating networked distributed aerospace systems. In this context, our research focus in 2016 centered on coordination approaches for joint observations by small satellites. Under the framework of the Telematics International Mission (TIM), the teams from the University of Würzburg (Germany) and TUM have combined their expertise to perform joint research on the Bavarian contribution to the mission, *TOM* (Telematics Earth Observation Mission). *TOM* consists of three picosatellites cooperating in attitude and position estimation, as well as in control activities (figure 3). The objective is to improve observation results by targeting the same surface areas with cameras on each satellite, and to perform subsequent data fusion from different viewing perspectives to obtain 3-D images. A prerequisite to this will be ensuring a stable flying formation and coordinated pointing for the multi-satellite system, which will be the core contribution of our team. During 2016, we prepared the relevant sensor and control technologies as well as testbeds to gear up for the start of mission implementation in 2017.

The SADAS group also had an active role when, back in 2014, Siemens CT (represented by Rudolf Diesel Industry Fellow, Gernot Spiegelberg) launched the department, *eAircraft*, in order to develop a high-power-density electrical motor for electric flying in cooperation with Airbus. In 2016, *eAircraft* received the certification to develop airborne systems. At this juncture, the knowledge and advances gained through the German Federal Ministry of Economics and Technology's (BMWi) Project RACE will be further advanced by combining them with aerospace technology. This Project RACE work culminated in 2015 with the development of a duo-duplex architecture with Ethernet communication of two centralized main computers for safety critical systems as drive-by-wire or fly-by-wire. By using this approach, the link between two key technology domains will be accomplished by implementation of autonomous driving and autonomous flying on the same integration platform – at low cost.

*Three doctoral candidates associated to our Focus Group – Stanislav Braun, Markus Geiser and David Seiferth – worked in close collaboration with us on all of these projects.*

2 | SAGITTA demonstrator testing in 2016 – engine, data link, navigation and manual / automatic (self-driving) taxi tests at the Manching Airfield near Munich.



3 | Bavarian contribution to the Telematics International Mission (TIM): TOM (Telematics earth Observation Mission), developed by teams from the University of Würzburg and TUM.

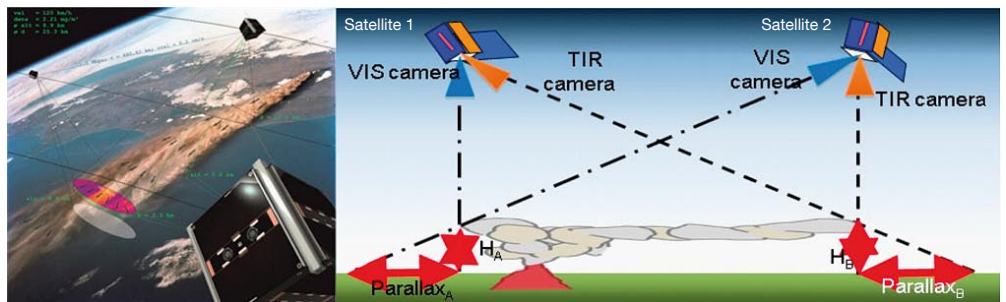

### Selected Publications

- [1] K. Schilling, "Perspectives for miniaturized, distributed, networked cooperating systems for space exploration," *Rob. Auton. Syst.*, vol. 90, pp. 118–124, 2016.
- [2] M. E. Kügler, and F. Holzapfel, "Developing automated contingency procedures for the ATOL system of a fixed-wing UAV through online FDD," in *AIAA Modeling and Simulation Technologies Conference*, Washington D. C., USA, 2016, no. 3221.
- [3] M. Vrdoljak, F. Viertler, M. Hajek, and M. Heller, "Helicopter pilot model for pitch attitude tracking task," in *Euro GNC 2017 – 4th CEAS Specialist Conference on Guidance, Navigation and Control*, Warsaw, Poland, accepted 2016.

*Publications by this Focus Group can also be found in the section Publications of this report.*

# Focus Group Environmental Sensing and Modeling

Prof. Jia Chen (TUM) | Rudolf Mößbauer Tenure Track Professor  
Dr. Francisco Toja Silva, Dr. Yin Bai (TUM) | Postdoctoral Researchers  
Lijuan Lan (TUM) | Doctoral Candidate

Scientific Reports



Jia Chen

© Host  
Environmental Sensing  
and Modeling, TUM

## Urban greenhouse gas (GHG) emission monitoring and methodology development

This group's current research focus is on quantifying greenhouse gas emissions and understanding the metabolism of pollutants in urban environments. To achieve this goal, wide ranges of research topics need to be covered, both in modeling and experimental. Modeling includes meso- and micro-scale simulations. Experimental techniques include optical sensing using the sun or novel semiconductor lasers as light source, spectroscopic methods such as tunable diode laser spectroscopy, Fourier transform spectroscopy, ground-based and satellite-based remote sensing.

We aim to establish a regional sensor network with novel differential column measurements (figure 1), i.e., column measurements (XGHG) inside and outside of a given city or urban area. Using these measurements, combined with models of atmospheric transport (for example, computational fluid dynamics, CFD), the group wants to demonstrate a new experimental strategy to determine greenhouse gas and pollutant emissions in urban areas.

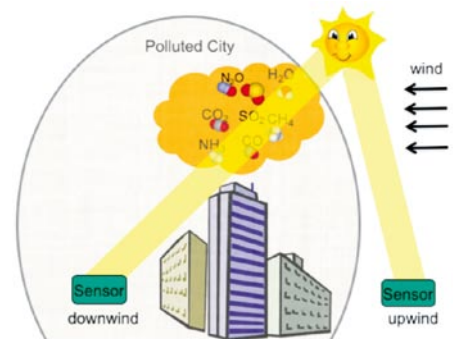

1 | Differential column measurement for emission determination in cities [1].

To deploy and improve the differential column measurement methodology for determining the GHG emissions in cities, we carried out field measurements with international partners (Harvard University, Purdue University, UC Berkeley, Caltech, DLR, KIT, LANL) in Indianapolis and San Francisco using 5–6 solar-tracking Fourier transform spectrometers.

We are particularly interested in the accuracy of this novel method, and have deployed 2–3 spectrometers to determine the emission rate of CO<sub>2</sub> and CH<sub>4</sub> of Heizkraftwerk Süd (powerplant south) in Munich. We took measurements in both winter and summer, using different measurement strategies. Based on the data gathered, we have determined an emission rate which matches well with the inflow.

We are carrying out CFD simulations of GHG emission from thermal power plants in urban environments (figure 2). We are validating these simulations by comparing the results with experimental measurements of XGHG. These results have also led to the improvement of the design of measurement campaigns.

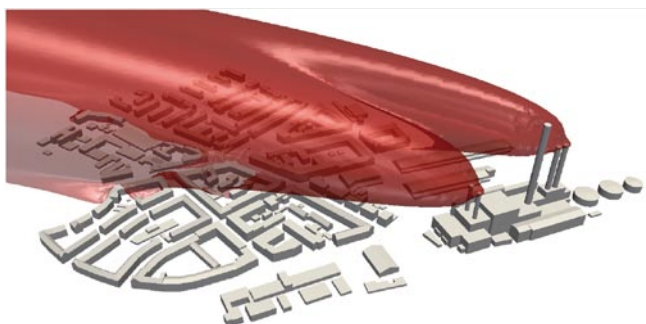

2 | Isosurface for CO<sub>2</sub> concentration of 425 ppm (left), surface concentration of CO<sub>2</sub> at z = 2m (right).

Another approach for differential column measurements followed by our group is the analysis of column averaged carbon dioxide XCO<sub>2</sub> and solar induced fluorescence (SIF) measurements from the Orbiting Carbon Observatory-2 Satellite (OCO-2). Compared with stationary spectrometers, measurements gathered via a moving satellite provide a global and spatial continuous coverage of XCO<sub>2</sub> in our planet's atmosphere. Over the course of 2016, we reliably detected urban areas of different sizes, geographical locations and structure as local carbon sources.

To deploy the compact spectrometers for stationary monitoring of urban emissions, an automatic protection and control system has been developed and patented. Since August 2015, we have been measuring GHG concentrations in central Munich.

The Focus Group is also developing optical sensors for measuring CO<sub>2</sub>, CO and CH<sub>4</sub> and particle concentrations in the urban area. The compact sensors use vertical cavity surface emitting laser (VCSEL) and LEDs. They are based on the principles of tunable diode laser absorption spectroscopy (TDLAS), wavelength modulation spectroscopy (WMS) and Cavity attenuation phase-shift spectroscopy (CAPS).

#### Selected Publications

- [1] J. Chen, C. Viatte, J. K. Hedelius, T. Jones, J. E. Franklin, H. Parker, E. W. Gottlieb, P. O. Wennberg, M. K. Dubey, and S. C. Wofsy, "Differential column measurements using compact solar-tracking spectrometers," *Atmos. Chem. Phys.*, vol. 16, pp. 8479–8498, 2016.
- [2] J. Chen, J. K. Hedelius, C. Viatte, T. Jones, J. E. Franklin, H. Parker, E. W. Gottlieb, P. O. Wennberg, M. K. Dubey, and S. C. Wofsy, "Study of differential column measurements for urban greenhouse gas emission monitoring," in *EGU General Assembly 2016, Vienna, Austria*, vol. 18, pp. 3244–3248.

*Publications by this Focus Group can also be found in the section Publications of this report.*

# Focus Group High-Resolution Gravity Modeling

Dr. Christian Hirt (Curtin University and TUM) | Hans Fischer Fellow  
Moritz Rexer (TUM) | Doctoral Candidate

## Scientific Reports



Christian Hirt

### © Host

Prof. Roland Pail  
Astronomical and Physical Geodesy, TUM

The research goal of the Focus Group High-Resolution Gravity Modeling is the development of a gravity field model with highest resolution of about 100 to 200 m over land and coastal areas of our planet. Such a gravity field model is important for several geoscience and engineering applications. For instance, gravity is a fundamental quantity for precision heighting and topographic mapping with satellite systems. In geophysics, gravity is crucial for making inferences on the location and size of mass-density anomalies, e.g., salt domes or iron-ore bodies. In metrology, gravity is required for the calibration of precision scales. In these and other applications, the higher the spatial resolution of the gravity model, the better the representation of field structures, and, hence, the overall applicability of the model.

To achieve this goal, the group's research focus is on (a) assessment and improvement of modeling methods; (b) assessment and combination of data sets (observations of the gravity field and auxiliary data such as topography models carrying information on the gravity field); and (c) application of methods and data to create products describing the gravity field to ultra-high resolution.

In 2016, the Focus Group's research activities centered on the development of new computational techniques for 3-D gravity modeling from masses arranged in layers. The new technique [1] can be applied, for example, to accurately compute the gravity field generated by ocean water masses, which are bounded by the seafloor (known from depth measurements) and the water surface (known from satellite observations). The computational techniques work in the spectral domain – that is, the field structures are represented through series of weighted sine- and cosine terms – and take into account the ellipsoidal shape of the Earth. This is a novel aspect of our work and important in practice, given that the shape of planet Earth is much closer to an ellipsoid of revolution than a sphere. The new technique has been applied to generate a new, high-resolution synthetic model of the Earth's gravity field, as generated by the known masses of the topography (mountain and valleys), water masses of the oceans and the Earth's major lakes and major ice-sheets. The model was released under the name dV\_ELL\_Earth2014 via the services of the International Association of Geodesy. The research described in [1] was made possible thanks to major contributions by the group's doctoral candidate, Moritz Rexer, whose PhD thesis is near completion.

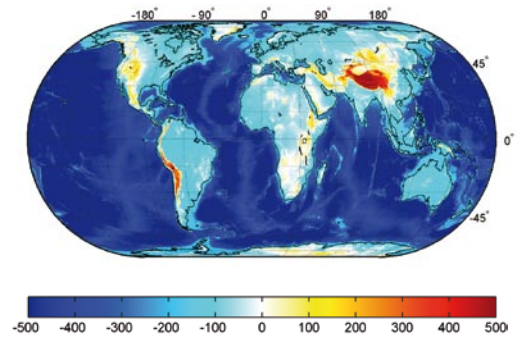

1 | The gravity field generated by the Earth's topographic, water and ice masses, computed with the so-called 'layer-based gravity forward modeling approach in ellipsoidal approximation.' The panel shows the gravity effect at the Earth's surface, obtained from our model "dV\_ELL\_Earth2014". Mass excess (e.g., over the Himalayas) results in a strongly positive gravity effect. Unit in  $10^{-6} \text{ m s}^{-2}$  [1].



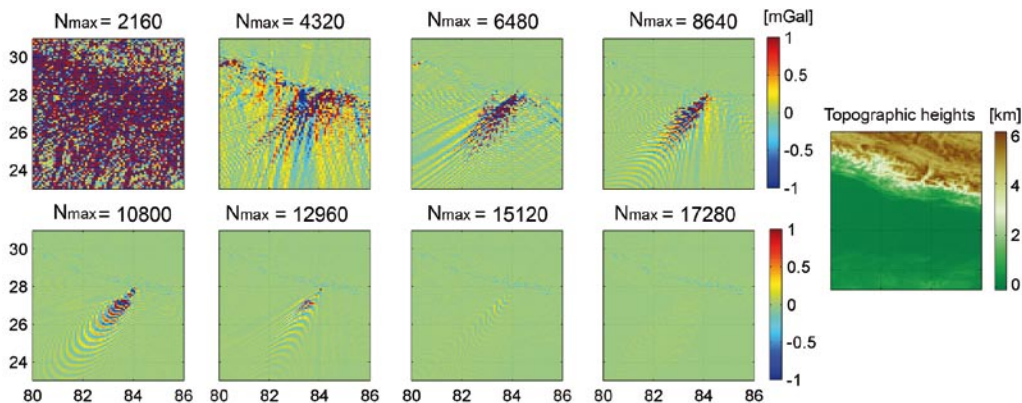

2 | Artefacts in gravity values produced by the spectral gravity modeling technique. The panel shows the necessity to extend the gravity modeling to extremely fine spatial scales (1 km) when the gravity field is modelled with high accuracy from a topography model with 10 km resolution. The artefacts, named “fan effect of spectral gravity modeling” were discovered in the work by Hirt et al. [2]. Unit in  $10^{-5}$  m s<sup>-2</sup> [2].

A second focus of our work was on the rigorous validation of different computational techniques used in the modeling of gravity fields from given mass distributions [2]. We applied strategies developed by the group for the first time to validate gravity model computations at 10 km spatial resolution, and were able to demonstrate excellent agreement (level of  $10^{-6}$  m s<sup>-2</sup>) for gravity accelerations from two independent modeling techniques [2]. The numerical experiments involved were numerically extremely expensive because several gravity models consisting of 233 million coefficients had to be computed. The work presented was the first to demonstrate the correctness of gravity modeling techniques based on mass distributions and 10 km resolution.

Further work concentrated on the assessment of new-generation topography data sets from the German TanDEM-X space mission and quantification of approximation errors in gravity modeling, both studies of which are important to ensure sufficient accuracy in present and future gravity products developed by the group members. A key publication summarizing the state-of-the-art of gravity modeling using topography data sets appeared in the handbook of geodesy [3]. Finally, it is worth mentioning that our research activities will be continued and extended to highest spatial resolution thanks to funding provided by German National Research Foundation (2016–2018). This follow-up research would not have been possible without the support provided by the TUM-IAS to our Focus Group from 2013–2016.

### Selected Publications

- [1] M. Rexer, C. Hirt, S. J. Claessens, and R. Tenzer, “Layer-based modeling of the Earth’s gravitational potential up to 10km-scale in spherical harmonics in spherical and ellipsoidal approximation,” *Surveys in Geophysics*, vol. 37, no. 6, pp. 1035–1074, 2016.
- [2] C. Hirt, E. Reußner, M. Rexer, and M. Kuhn, “Topographic gravity modeling for global Bouguer maps to degree 2,160: Validation of spectral and spatial domain forward modeling techniques at the 10 microgal level,” *Journal of Geophysical Research – Solid Earth*, vol. 121, no. 9, pp., 6846–6862, 2016.
- [3] C. Hirt, “Topographische Modellierung des Gravitationsfeldes,” in *Handbuch der Geodäsie*, W. Freeden und R. Rummel, Eds. Berlin, New York: Springer, 2016.

*Publications by this Focus Group can also be found in the section Publications of this report.*

# Focus Group Sustainable Water Cycles for Cities of the Future

Prof. Stuart Khan (University of New South Wales) | Hans Fischer Fellow  
 Philipp Michel (TUM) | Doctoral Candidate

## Scientific Reports



Stuart Khan

© Host  
 Prof. Jörg Drewes  
 Urban Water Systems  
 Engineering, TUM

The principal objective of the EU Water Framework Directive (WFD) is to protect water quality and ecological attributes of Europe's rivers, lakes, groundwater and coastal beaches. An important focus of the WFD is the control of chemical substances that may, when released into bodies of water, result in detrimental ecological impacts. Priority chemical substances have been identified according to approaches outlined in the WFD. Advanced wastewater treatment technologies have been proposed to reduce contaminant loads from these point sources. However, these advanced treatment technologies are energy intensive, operationally complex and expensive. In light of these considerations, the investment in the implementation of advanced treatment technologies should be balanced against the environmental benefits versus environmental impacts and financial costs. The relationship between these costs and benefits will vary – both between locations and also over time.

A central research focus is the understanding and modeling of cause-effect relationships which could provide a mean for dynamic and more quantified decision-making for advanced wastewater treatment, driven by machine learning approaches. This approach could result in significant savings in overall energy consumption, and thus lower costs and greenhouse gas emissions. Using state-of-the-art modeling approaches, this research will advance the predictive capacity for diverse contaminant concentrations in wastewater treatment and receiving environmental systems.

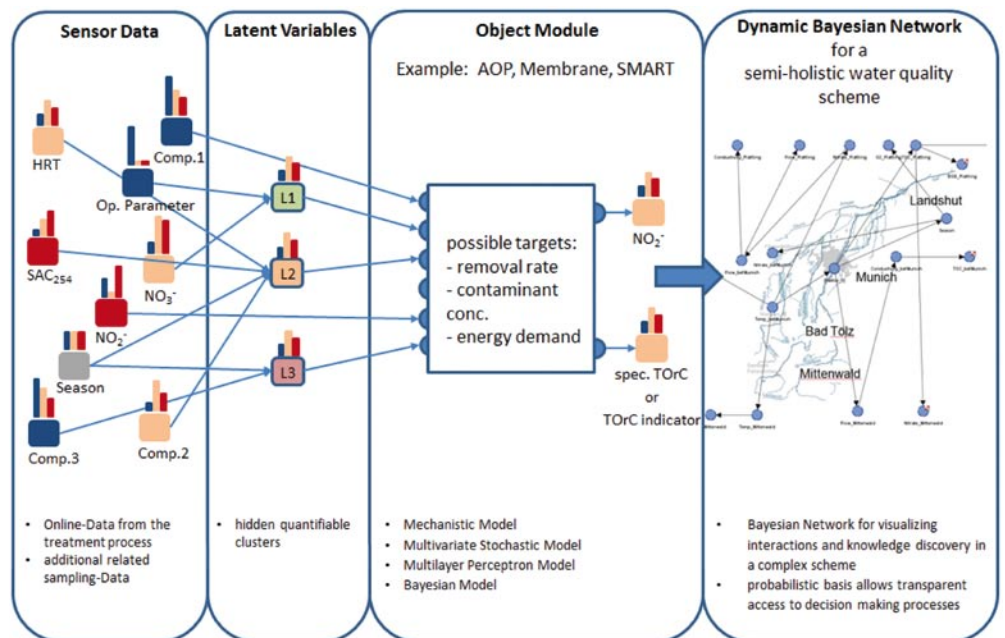

1 | Schematic data processing.

The focus of this study is on the removal of trace organic chemicals and surrogate parameters that correlate with their removal. Issues related to data, model structures, incorporations of variability and uncertainty, calibration, potential surrogate parameters, and model validation will be investigated. The contributions of existing systems and parameters determining environmental contaminant concentrations

(e.g., source variability, existing treatment, discharge dilution, environmental processing) will be accounted for. Figure 1 illustrates a dynamic system in assessing water quality. In this concept, surrogates and generated latent variables feed into a fate model based either on mechanistic or multivariate stochastic mechanisms. Subsequently, the modelled target variables and their probabilities of occurrence feed into a holistic Bayesian network. This allows further decision making based on a yet not common transparent scheme. This approach of the field of machine learning will employ and evaluate clustering machine learning, probabilistic modeling including “Bayesian belief networks” (BBN) with partially static and online data-driven data sources. The final target is a comprehensive dynamic monitoring approach, which is dealing with relevant system variations in real-time context.

In 2016, the main focus of our work was to complete a review paper which discusses the potential of current regulatory tools and controls for a dynamic water quality risk profile in water quality management. Additionally, a large field sampling campaign at the wastewater treatment plant Munich II was performed, which provides the major basis for the data analysis. For the latter, the computational basis for the different machine-learning modules was developed.

A further aspect of this sampling campaign was to investigate advanced statistical machine-learning concepts with the perspective to capture new multi-dimensional sensory data (3D-fluorescence) and so called software sensors. By embedding this data in the machine-learning environment, we are proposing a new process for knowledge discovery and information gathering. Publications for this Ph.D. project are currently in the preparation stage. At the start of the year, Stuart Khan and Jörg Drewes were successful in attracting a joint funding grant in the context of the Australia-Germany Joint Research Cooperation Scheme being a joint initiative of Universities Australia and the German Academic Exchange Service (DAAD). This funding was earmarked to facilitate the exchange of doctoral candidates between TUM and the University of New South Wales (UNSW) during 2016 and 2017.

Doctoral candidate Philipp Michel visited the UNSW from January 18 to March 31, 2016, to undertake collaborations with Stuart Khan and his Australian doctoral candidates. During this time, Philipp Michel worked on developing new skills with Bayesian network modeling and machine learning, and strengthened the collaboration with doctoral candidate Guido Carvajal Ortega at UNSW. From June 11 to July 16, 2016, Stuart Khan visited TUM. During this time, he visited the Universidade Nova de Lisboa where he gave a presentation on emerging issues in urban water quality management. Between August 25 to October 7, 2016, Guido Carvajal Ortega visited TUM. This visit was funded by the DAAD Australia-Germany Joint Research Cooperation Scheme. During this visit, he conducted research on disinfection performance evaluation during ozonation of secondary effluent using Bayesian analysis. Doctoral candidate Philipp Michel is now preparing for a second visit to UNSW in 2017.

Throughout 2016, Jörg Drewes and Stuart Khan have been working together on the organizing committee for the largest international water reclamation and reuse conference, which will take place in Long Beach, California during July 2017. Drewes will serve as chair of the conference. Moreover, Stuart Khan and Jörg Drewes co-authored a new chapter in a forthcoming book on “Advanced Oxidation Processes for Water Treatment.” The chapter focuses on applications of advanced oxidation for potable water reuse. The book will be published by the International Water Association (IWA) in early 2017 [1].

## Reference

- [1] S. J. Khan, T. Walker, B. D. Stanford, and J. E. Drewes, “Advanced treatment for potable water reuse,” in *Advanced Oxidation Processes for Water Treatment: Fundamentals and Applications*, Mihaela I. Stefan, Ed. London: IWA Publishing, 2017, ch. 14.

*Publications by this Focus Group can also be found in the section Publications of this report.*

## Focus Group Global Change

Prof. Annette Menzel (TUM) | Carl von Linde Senior Fellow

Prof. Dianne Newell (University of British Columbia) | Visiting Fellow

Dr. Ricardo Acevedo-Cabra | Postdoctoral Researcher

### Scientific Reports



Annette Menzel

### Host

Ecoclimatology, TUM

### Alumni Members

Prof. Tim H. Sparks

(Coventry University)

Hans Fischer Senior Fellow

Dr. Nicole Estrella (TUM),

Prof. Susanne Jochner

(Catholic University of

Eichstätt-Ingolstadt),

Dr. Christian Zang (TUM)

Postdoctoral Researchers

Dr. Julia Laube (TUM),

Dr. Anna Bock (LfU)

Doctoral Candidates

## Is there a limit to phenological advance by climate change-induced warming?

Phenology, such as flowering and bud burst, is strongly determined by spring temperatures, and with climate warming, such events have been observed as occurring progressively earlier in the year. Phenology is therefore a suitable bio-indicator of climate change, mirroring spring temperatures almost linearly. In the future, can we expect a greening of the vegetation to occur around Christmas or even earlier?

The Focus Group Global Change is concentrated on this topic of universal interest: If climate warming continues, will there be a natural limit in phenological advance, e.g., triggered by a short photoperiod or lack of chilling in the preceding autumn / winter months? This would lead to a flattening of the linear response, and a loss of temperature sensitivity [1]. Long-term datasets demonstrate this flattening at the colder edge of the temperature range (see figure 1). For the period 1951–2012, we analyzed more than 550,000 annual observations of spring phenological phases (flowering, leafing) at more than 3,500 sites across 22 countries in Europe [4]. The mean sensitivity of phases varied among species, ranging from  $-7.7$  days  $^{\circ}\text{C}^{-1}$  for the flowering of hazel (occurring in early spring) to  $-2.7$  days  $^{\circ}\text{C}^{-1}$  for the leafing of European beech and oak (usually observed in mid-May). In contrast to our hypothesis, we could not identify a general loss of sensitivity at the warmer edge of our dataset. For only 14 percent of the time series, there was an s-shaped model solution of the temperature response superior to a linear one. However, most of the series revealed a flattening of the response at the cooler edge, pointing to a natural limit of delay to onsets in exceptionally cold springs.

The Focus Group continued to work on this topic together with Tim Sparks, who joined us again during a visiting guest professorship in summer 2016. For this project, we concentrated on a small perennial plant species re-sprouting in spring from subsoil rhizomes. Here, we found an interesting novel aspect: Weather conditions in autumn seemed to influence spring phenology – most likely by modifying plant respiration and thus altering the plant's stored starch reserves. Equally, this proposed process may set a natural limit to warming-induced advance in phenology.

## Pollen-free offices in research buildings?

Pollen-induced allergies constitute a major health risk for ~15 percent of the German population. Since people – whether staff, students or scientists at universities – spend most of their time indoors (on average 90 percent of the day), standard measurements of airborne pollen concentration on elevated rooftops do not mirror the actual amount of exposure an individual has to airborne pollen. Our group measured ambient pollen concentrations in offices in buildings of the Technical University of Munich at Freising and of KIT at Garmisch-Partenkirchen [5]. As expected, indoor pollen concentrations were generally lower than outside concentrations. The I/O ratios (indoor/outdoor concentration) ranged, for example, between 0.07 and 0.75 (Birch pollen 2015 in Freising).

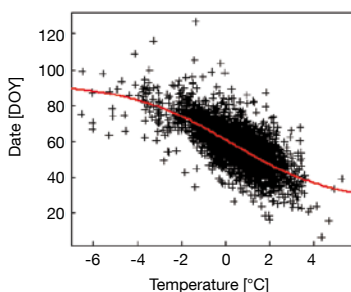

1 | Site-specific mean onset dates (day of the year) versus mean early spring temperature for hazel flowering across Europe. Line represents the nonlinear (sigmoidal) fit.

However, these ratios strongly depended on outside meteorology and ventilation schemes. Tilted windows were compared to short ventilation, though there was no consistent difference between the two. Hourly I/O ratios increased with the outside temperature, wind speeds, and wind direction perpendicular to the window opening. Pollen accumulating in the rooms led to increased, medically relevant concentrations at times when outside pollen concentration may have fallen again.

## Monitoring climate change in the subarctic – hidden treasures at TUM

The sub-Arctic land surface temperature has substantially warmed since the mid-20th century, leading to drastic changes in the biosphere – specifically in the phenology of plants and animals in Greenland. Equally, the extent of Arctic sea ice dramatically decreased between 1979 and 2012. Whereas current data products show that it is certain that globally averaged land surface temperature has risen since the late 19th century, there is low confidence in changes prior to 1880, especially due to a reduced number of stations.

The Arctic is one region where historical meteorological datasets are extremely sparse, and any supplemental data is welcome. In a joint cooperation with Dianne Newell and Cornelia Lüdecke (Center for History of Science and Technology, University of Hamburg), we worked on meteorological observations at the Moravian Brethren's Labrador and Greenland missions. The professorship of Ecoclimatology has surviving collections of duplicated, handwritten instrumental meteorological records and observations conducted at the Moravian stations (figure 2). They cover the period from 1841 to 1879, and seem to be a unique and valuable source for the work of historical climatology in sub-Arctic regions. We reviewed the range of historical data available in both archival collections and historical publications, then digitized a feasible amount of this collection and combined the data with more recent data. Initial analyses demonstrate a huge potential of these data to study changes in the sub-Arctic, especially pertaining to the frequency of polar lows which will be presented in 2017 at the EGU General Assembly in Vienna [2]–[3].



2 | Photo of the so-called Lamont copies collection of unpublished Moravian meteorological data of the 19th century from mission stations in Labrador and Greenland.

### References

- [1] Y. H. Fu, H. Zhao, S. Piao, M. Peaucelle, S. Peng, G. Zhou, P. Ciais, M. Huang, A. Menzel, J. Peñuelas, Y. Song, Y. Vitasse, Z. Zeng, and I. A. Janssens, “Declining global warming effects on the phenology of spring leaf unfolding,” *Nature*, vol. 526, no. 7571, pp. 104–107, 2015.
- [2] M. Matiu, C. Lüdecke, D. Newell, and A. Menzel, “Polar lows in the Labrador Sea based on the Moravian historical collection of meteorological data in Labrador and Greenland since the mid-18th century,” in 2017 European Geosciences Union, Vienna, Austria, vol. 19, no. EGU2017-7827.
- [3] D. Newell, C. Lüdecke, and A. Menzel, “The science behind Moravian meteorological observations for late-18th century Labrador,” in 2017 European Geosciences Union, Vienna, Austria, vol. 19, no. EGU2017-19294.

### Selected Publications

- [4] S. Jochner, T. H. Sparks, J. Laube, and A. Menzel, “Can we detect a nonlinear response to temperature in European plant phenology?” *Int. J. Biometeorol.*, vol. 60, no. 10, pp. 1551–1561, 2016.
- [5] A. Menzel, M. Matiu, R. Michaelis, and S. Jochner, “Indoor birch pollen concentrations differ with ventilation scheme, room location and meteorological factors,” *Indoor Air*, 2016.

*Publications by this Focus Group can also be found in the section Publications of this report.*

## Focus Group **Modeling Spatial Mobility**

Prof. Rolf Moeckel (TUM) | Rudolf Mößbauer Tenure Track Professor  
Dr. Ana Tsui Moreno Chou, Dr. Carlos Llorca Garcia,  
Dr. Matthew Bediako Okrah (TUM) | Postdoctoral Researchers  
Shihang Zhang (TUM) | Doctoral Candidate

Scientific Reports



Rolf Moeckel

© Host  
Modeling Spatial  
Mobility, TUM

### Taking on the challenge of transportation issues in the 21st century

The goal of research for the Modeling Spatial Mobility (MSM) Focus Group is to improve integrated land use / transportation modeling to promote advanced scenario analysis. This includes the development of models for land use and transportation by utilizing data from a variety of sources, including census data, surveys and crowd-sourcing data. Our work also incorporates data from the spatial analysis of travel behavior and location choice of households and firms. The interaction between land use and transport is of special interest: ultimately, models and spatial analysis should facilitate the improvement of policy analysis by enhancing scenario capabilities – and by making model sensitivities more realistic.

Currently, an integrated land use / transport modeling suite for the Munich metropolitan area is under development. The Base year is 2010, and the model will simulate land use and travel behavior until 2050. The study area consists of 444 municipalities with a population of 4.5 million living in 2.2 million households. The study area has been delineated based on commuter flows and is shown in figure 1. The size of the study area was chosen because of the long commute distances and times prevalent in the Munich metro region: these are driven, in part, by Munich's relatively high real estate and rental prices.

The model will be used to improve our understanding of the impact of public policies – such as increased transit fares, zoning restrictions and new transport infrastructure. The model will also be applied to test technological advances in transportation, such as autonomous vehicles or advanced communication technologies. Last but not least, global trends, such as the development of energy prices, will be analyzed with the model. Ultimately, such models are utilized to inform policy making and for testing what-if scenarios.

To create a consistent zone system for this study area, a raster cell system was created based on the quadtree algorithm. This method creates smaller raster cells in urban areas, and larger raster cells in rural regions, thereby allocating resources in proportion to levels of activity. This approach to modeling has been enhanced by intersecting raster cells with jurisdictional boundaries: resulting slivers and small pieces of raster cells were merged with neighboring raster cells in the same municipality. Figure 2 shows raster cells for the city of Munich and a few surrounding municipalities. For the entire study area, 5,428 raster cells were generated. The method is flexible, and it is possible to generate more or fewer raster cells for selected studies.

All models are built as microsimulation models. In aggregate models, the same level of aggregation of socio-demographic data is carried through the entire model. Using micro data instead allows every module to use different attributes of the micro data, or aggregations thereof.

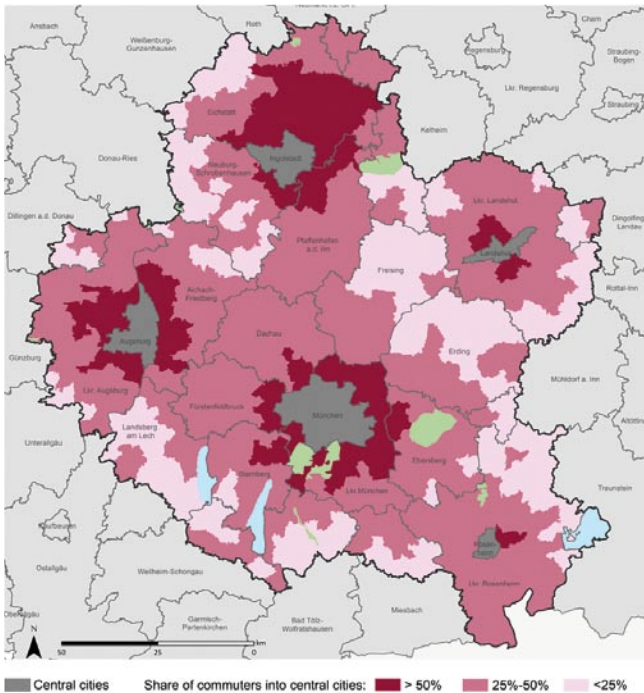

1 | Munich metropolitan area for the integrated land use / transport model.

Model development follows the agile approach. In this paradigm – borrowed from computer science – the simplest model possible is implemented initially, and subsequently and gradually improved as necessary. In this concept, an operational model is maintained from the very beginning. At every step, the results are validated against observed data. The step that performs the least satisfactorily will be improved upon next. The agile approach applies both to model design and to data. In many cases, data may be borrowed from other models to speed up model implementation. Where borrowed data are found to work unsatisfactorily, they are replaced with local data.

The modeling suite developed by our group contains several modules, including SILO for land use, MITO for travel demand (both developed at TUM) and MATSim (developed at ETH Zurich and TU Berlin) for the assignment. All models are written in Java, which facilitates their tight integration. In 2016, a synthetic population was created, a microscopic trip generation module was implemented and we developed a module to calculate travel time budgets for every household.



2 | Raster cells in Munich reflecting population and employment densities in zone sizes.

Also, the highway and road network utilized in our model was created using open-source street maps, and initial traffic assignments in MATSim were implemented successfully. The next steps in the process will include the addition of microscopic destination choice and mode choice models.

All models developed by this research group are open source under the auspices of the GNU licensing agreement, and are available at <https://github.com/msmobility> free of charge. Interested users are welcome to download, use and further develop these models. Additionally, data to run these models are shared – so long as the sharing thereof doesn't violate privacy concerns.

#### Selected Publications

- [1] C. Dawkins and R. Moeckel, "Transit-induced gentrification: who will stay, and who will go?" *Housing Policy Debate*, vol. 26, no. 4–5, pp. 801–818, 2016.
- [2] R. Moeckel and K. Nagel, "Maintaining mobility in substantial urban growth futures," *Transport. Res. Procedia*, vol. 19, pp. 70–80, 2016.
- [3] R. Moeckel and R. Donnelly, "A model for national freight flows, distribution centers, empty trucks and urban truck movements," *Transport. Plan. Techn.*, vol. 39, no. 7, pp. 693–711, 2016.

*Publications by this Focus Group can also be found in the section Publications of this report.*

## Focus Group **Climate Flows**

Prof. Carlo Ratti (Massachusetts Institute of Technology & Carlo Ratti Associati)

Rudolf Diesel Industry Fellow

Daniele Santucci (TUM) | Doctoral Candidate

### Scientific Reports



Carlo Ratti

### © Host

[Prof. Thomas Auer](#)

Building Technology  
and Climate Responsive  
Design, TUM

## Climate Flows

In the future, climate change will increasingly manifest itself in cities and urban areas in a variety of direct and indirect ways. These phenomena will include ever more – and ever more extreme – adverse-type weather events such as heat waves, flooding and extreme discomfort conditions. We will also see more subtle changes occur, such as higher temperatures in urban microclimate areas, or worsening air quality. Alongside the challenges posed by changing climate conditions, urban population growth will lead to rapid densification in cities – by 2050, around two-thirds of the human population is predicted to be residing in cities and urban areas. This will place an ever-greater demand on resources – both natural and humanmade.

The totality of environmental conditions regulates the use of public space and influences socio-technical questions. And the evaluation of these conditions demands innovative computational methodologies and tools. Nowadays, there is a preponderance of research data available to social scientists – especially the manifold data of social life that is generated by human activities in cities and urban areas: public transport, everyday interactions and demographics, education, public health, crime, environment, etc. As a result, the challenge facing social scientists is not only the question of how to collect, process and interpret such huge arrays of information. It also lies in how to manage this data in an interdisciplinary setting, through the exchange of expertise between disparate disciplines in order to develop an integrated understanding of socio-technical environments and social interaction.

Recently, advancements in technologies and tools – such as in big data and high computational power and speed – are opening up a completely new platform for allowing us the ability to push into the microscale – and to monitor behaviors in high resolution. We've got a level of precision in terms of scale that, for example, doesn't just show us that when it rains, people in cities switch transport modes from bikes or trains to cars. The tools at hand can also tell us how people occupy and use public spaces in all seasons and weather. In light of this, the necessity for developing tools that allow us to sift through different layers of data gathering, data visualization and data mapping is growing in importance.

Within this framework, our research group is investigating the relationship between environmental conditions in urban areas and cities, and how people occupy and use urban spaces – especially in regards to individual mobility. Our aim is to determine a systematic relation. The methodology we've outlined previously will provide us with new approaches to understanding the influence of environmental conditions on human activity and the use of outdoor space in urban areas and cities. It will also provide us with more information on the ramifications of urban and mobility planning, which will – in turn – allow us to tailor this planning to both create more livable public spaces and counteract more frequent extreme climatic phenomena.



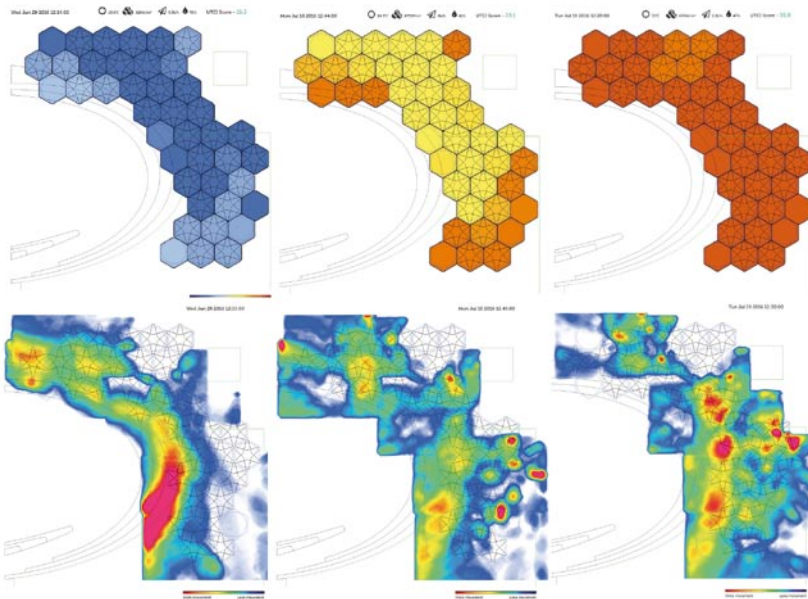

1 | Comparison between outdoor comfort (UTCI) – above – and movement patterns for a specific timeframe.

## Outdoor comfort dynamic model

The Elytra Pavilion at the Victoria & Albert Museum in London is being used as a case study to evaluate the relationship between the movement of humans in an urban public space and outdoor thermal comfort.

Our Focus Group is currently developing an “outdoor comfort model” based on ongoing measurements that look at conventional methods being used to assess thermal comfort (for example, the universal thermal climate index, or UTCI). We are working with models that measure and quantify comfort levels with different indices at specific moments in spatial distribution. The aim of this research is to map thermal comfort – both in time and space – to provide a spatio-temporal distribution of comfort levels. This will allow us to predict human response to changing microclimatic conditions. One of the first steps we took within this context was the integration of existing tools (including tools such as ENVI-met, TRNSYS and Grasshopper) – in lieu of developing a new one of our own. We integrated tools based on the accuracy of their outputs to increase the reliability of simulation results, and to compare them with real measured data. Outdoor comfort models require precise microclimate data to determine conditions with a high resolution. In an urban context, the morphology of the built environment and material properties are two key factors that influence microclimate: Based upon this assumption, ongoing studies are targeting patterns to correlate urban microclimate and density factors in cities.

To establish valid relations, the combination of a diverse set of methods is particularly important, because large datasets containing both location-based and social data have not yet been sufficiently systematically tested at different scales [1], especially not when they are comprised of rather heterogeneous data. The question of individual and intersubjective outdoor comfort is an interesting case – not only for the development of a multiplex approach, but also to facilitate the determination of which data in combination make sense – and what kind of biases can be ruled out, or which ones would prove useful in relation to the research questions.

*In collaboration with Eduard Mildemberger, a research assistant working at the Chair for Building Technology and Climate Responsive Design, TUM.*

### Reference

- [1] C. Herrera-Yagüe, C. M. Schneider, T. Couronné, Z. Smoreda, R. M. Benito, P. J. Zufiria, and M. C. González, “The anatomy of urban social networks and its implications in the searchability problem,” *Sci. Rep.*, vol. 5, no. 10265, 2015.

### Selected Publications

- [2] D. Santucci, T. Auer, and C. Frenzel, “Build simple – Climate engineering 2.0,” in *Proceedings of PLEA2016 – 32nd International Conference on Passive and Low Energy Architecture. Cities, Buildings, People: Towards Regenerative Environments*, P. LaRoche and M. Schiler, Eds., 2016.
- [3] D. Santucci, E. Mildemberger, and B. Plotnikov, “An investigation on the relation between outdoor comfort and people’s mobility – The Elytra Filament Pavilion survey,” in *PowerSkin Conference Proceedings, Munich, Germany*, pp. 97–107, 2017, accepted in 2016.

*Publications by this Focus Group can also be found in the section Publications of this report.*

## Focus Group Supramolecular Chemistry

Prof. Job Boekhoven (TUM) | Rudolf Mößbauer Tenure Track Professor  
Dr. Chandan Maity, Dr. Marta Tena Solsona (TUM) | Postdoctoral Researchers  
Raphael Grötsch, Benedikt Rieß, Caren Wanzke (TUM) | Doctoral Candidates

Scientific Reports



Job Boekhoven

© Host  
Supramolecular  
Chemistry, TUM

### Dynamic supramolecular materials

Supramolecular assemblies consist of molecular building blocks that are assembled via non-covalent interactions such as hydrogen bonding and ionic interactions. Material properties can be encoded into these building blocks, which give rise to supramolecular materials. Prominent examples include liquid crystals in LCDs, or amphiphiles compounds in detergents. In recent decades, there have been tremendous developments in the field of supramolecular materials, and as a result of combined efforts, the use of supramolecular materials can nowadays be found in a range of areas including healthcare and opto-electronics. Despite this progress, however, these materials remain rather simple, especially concerning responsiveness or adaptivity to environmental changes. That's especially true when compared to biological equilibrium supramolecular structures, like the cytoskeleton, but also when compared to entire cells and organs.

While most human-made materials reside in equilibrium and are thus controlled by thermodynamics, biological materials typically exist in states far-from-equilibrium, e.g., states driven by chemical reaction networks that consume chemical fuels such as ATP or GTP. In other words, these materials are controlled by chemical reactions (kinetics) rather than by thermodynamics. As a result of this kinetic control, biological materials are endowed with unique properties including a limited lifetime, robustness, adaptivity and the capacity to self-heal. Such unique material properties offer opportunities for materials science. Imagine, for instance, a packaging material that is able to self-heal when damaged, and which has a predefined lifetime after which it autonomously disintegrates.

Inspired by the unique properties that biological far-from-equilibrium materials offer, our group aims at designing and synthesizing analogs of such kinetically controlled materials – and testing their unique properties. In this process, supramolecular assemblies are coupled with two different chemical reactions: an activation and deactivation reaction. In the activation reaction, a building block consumes a chemical fuel, thus activating it for self-assembly. Only upon activation can assembly into the desired supramolecular material occur. Crucially, the activated building block is thermodynamically unfavored, and will ultimately be reverted to the original building blocks by the deactivation reaction. The associated supramolecular material is, as a result of the continuous activation and deactivation, dynamically formed and only present for as long as there is fuel.

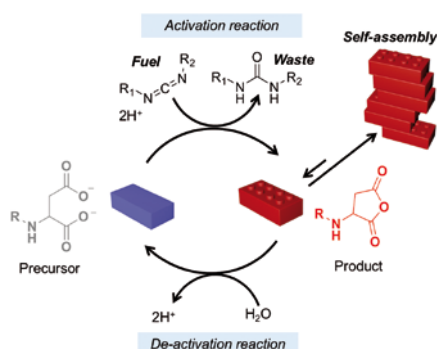

1 | Scheme of the chemical reaction network for the fuel-driven formation of a transient product. A dicarboxylate (precursor, blue brick) is converted into an anhydride (product, red brick) by consumption of a carbodiimide (fuel). The aqueous anhydride product is unstable and rapidly hydrolyzes back to the corresponding dicarboxylate precursor. The dicarboxylate precursor carries two negative charges while the anhydride product is uncharged. The loss of the charges decreases the solubility of the precursor and thereby induces self-assembly.

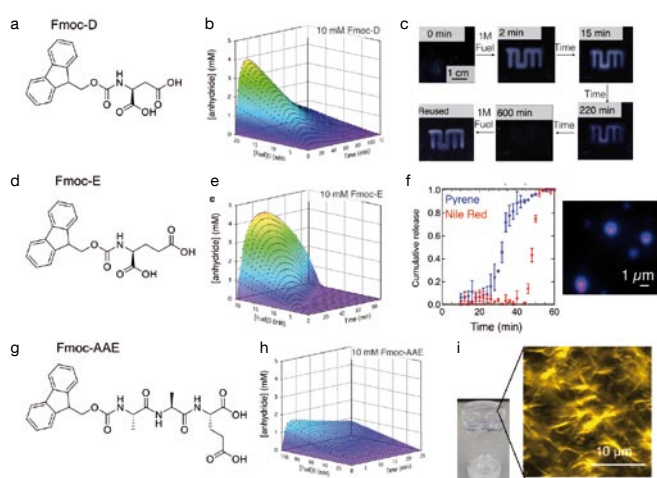

In the group's first year with the TUM-IAS, it realized the development of a successful chemical reaction network that has the ability to drive the formation of dynamic supramolecular materials. In this chemical reaction network, a dicarboxylate is converted into a metastable anhydride driven by the irreversible consumption of a carbodiimide (i.e. fuel). These anhydrides are intrinsically unstable and hydrolyze quickly to their original dicarboxylates. In other words, we can transiently create anhydrides in a chemical reaction network driven by chemical fuels (figure 1).

To couple this network with the formation and degradation of supramolecular material, we use the fact that the precursor carries two negative charges and is thus well soluble, while the metastable anhydride is uncharged and thus less soluble. We molecularly engineered the rest of the molecule to drive self-assembly of the less soluble anhydride into gel fibers, colloids and spherulites (figure 2). Over the course of our research, all these assemblies were shown to autonomously form in response to chemical fuels and degrade when they ran out of fuel. Interestingly, their lifetimes were tuned from minutes to hours by simply altering the components in the chemical reaction network. Reusability was also demonstrated by addition of another batch of fuel.

The transient nature of these assemblies was exploited as temporary supramolecular materials. For instance, Fmoc-D solutions with transient turbidity were used as a carrier for temporary messages with

(a, d, g) Molecular structures of the tested precursors Fmoc-D, Fmoc-E and Fmoc-AAE, respectively. (b, e, h) 3-D plots of the anhydride concentration against time after addition of fuel for different initial fuel concentrations for each precursor. (c) Self-erasing inks of Fmoc-D. Fmoc-D were embedded into polyacrylamide hydrogel. Only where fuel was applied does turbidity appears. The anhydride product hydrolyzed in water and the assemblies disappeared when the system ran out of fuel. The self-erasing medium could be reused several times. (f) Confocal micrographs Fmoc-E with fuel in the presence of Nile Red and pyrene (dyes were added sequentially) and sequentially release profiles of pyrene (blue markers) and Nile Red (red markers) from the particle. (h) Photograph and confocal micrographs of a transient hydrogel from FmocAAE with fuel.

a tunable lifetime (figure 2a–c). Fmoc-E formed large colloids, which were explored as vehicles that released hydrophobic contents in a predictable fashion (figure 2d–f). Finally, Fmoc-tripeptides, like Fmoc-AAE, self-assembled into hydrogels that autonomously and with a predefined lifetime turned back to liquids (figure 2g–i).

Taken together, our Focus Group has demonstrated that simply coupling the formation of supramolecular materials with a fuel-driven chemical reaction network endows the resulting materials with unique properties. In this work, we have exploited the spatial and temporal control over the material as one of the unique properties which we demonstrate by self-erasing inks, colloids that fall apart with predictable lifetimes and thus release their contents predictably and hydrogels that turn into fluids at a tunable time.

#### Selected Publication

- [1] T. Tantakitti, J. Boekhoven, X. Wang, R. Kazantsev, T. Yu, J. Li, E. Zhuang, F. Zandi, J. Ortony, C. Newcomb, L. Palmer, S. M. Gajendra de la Cruz, G. Schatz, and S. Stupp, "Energy landscapes of supramolecular systems determine their function," *Nat. Mater.*, vol. 15, no. 4, pp. 469–476, 2016.

*Publications by this Focus Group can also be found in the section Publications of this report.*

# Focus Group **Functional Metagenomics**

Prof. Yana Bromberg (Rutgers University) | Hans Fischer Fellow  
Yannick Mahlich (TUM) | Doctoral Candidate

## Scientific Reports



Yana Bromberg

## © Host

Prof. Burkhard Rost  
Bioinformatics, TUM

During the past year, the Functional Metagenomics Focus Group finalized a number of tasks it originally set out to accomplish. This included: (1) building a database of microorganism functional similarities, fusionDB, with an intuitive interface and a built-in ability to analyze newly sequenced microorganisms (figure 1) and (2) creating a new method for mapping reads to parent protein functions and building a metagenome-to-function pipeline, mi-faser. Both publications have been submitted and the associated computational resources are publicly available from the bromberglab.org services website. Additionally, we showed that our new, sequence-based predictor of type III secreted effectors, pEffect, is just as accurate in annotating sequencing reads as it is full length proteins – a finding that makes pEffect the next perfect candidate to be plugged into our mi-faser metagenome analysis pipeline.

When taken together, these developments allow for fast and accurate interpretations of metagenomic and transcriptomic data allowing for new discoveries. For example, we demonstrate that closely related microorganisms could share less functionality than unrelated members of the same environment (figure 1). In a more applied approach, we could also demonstrate that our analysis can distinguish gut microbiomes of Crohn's patients from that of their healthy relatives, even when they reside in the same household (figure 2).

## Resources

- Type III secretion prediction:  
<http://services.bromberglab.org/peffect>
- Functional analysis of microbiomes (submit metagenome/transcriptome data)  
<http://services.bromberglab.org/mifaser>
- Analysis of microbial functional similarities (submit microbial proteome)  
<http://services.bromberglab.org/fusiondb/>

## References

- [1] C. Zhu, M. Miller, S. Marpaka , P. Vaysberg , M. C. Rühlemann, F. A. Heinsen, M. Tempel , W. Lieb, A. Franke, and Y. Bromberg, "Accurate read-based annotation of metagenome functionality," submitted.
- [2] C. Zhu, Y. Mahlich , M. Miller, and Y. Bromberg, "fusionDB: assessing microbial diversity and environmental preferences via functional similarity networks," submitted.

## Selected Publications

- [3] T. Goldberg, B. Rost, and Y. Bromberg, "Computational prediction shines light on type III secretion origins," Nat. Sci. Rep., vol. 6, no. 34516, 2016.
- [4] Y. Bromberg, M. W. Hahn, and P. Radivojac, "Computational approaches to the understanding of evolution of molecular function," in Proceedings of the Pacific Symposium on Biocomputing, Hawaii, USA, 2016, vol. 22, pp. 1–2.

*Publications by this Focus Group can also be found in the section Publications of this report.*

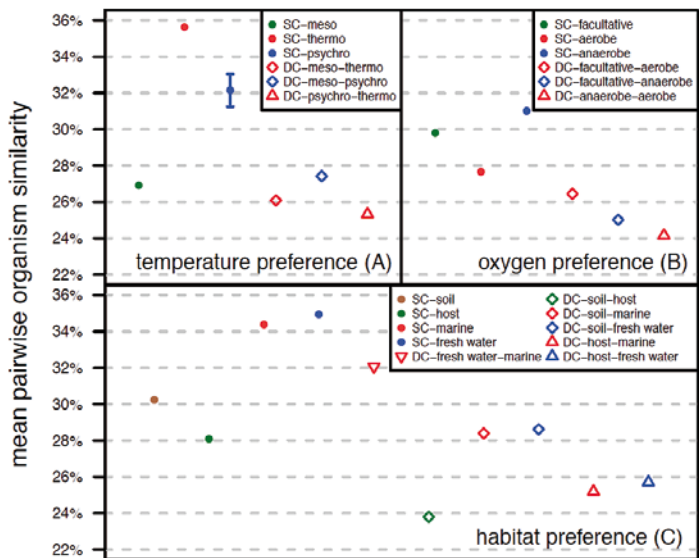

1 | Organism pairwise similarity is higher among organisms living in the same environmental conditions. The mean pairwise similarity for same (SC) and different (DC) condition organisms according to (A) temperature preference, (B) oxygen requirement, and (C) habitat. For all points without error bars, the standard errors are vanishingly small.

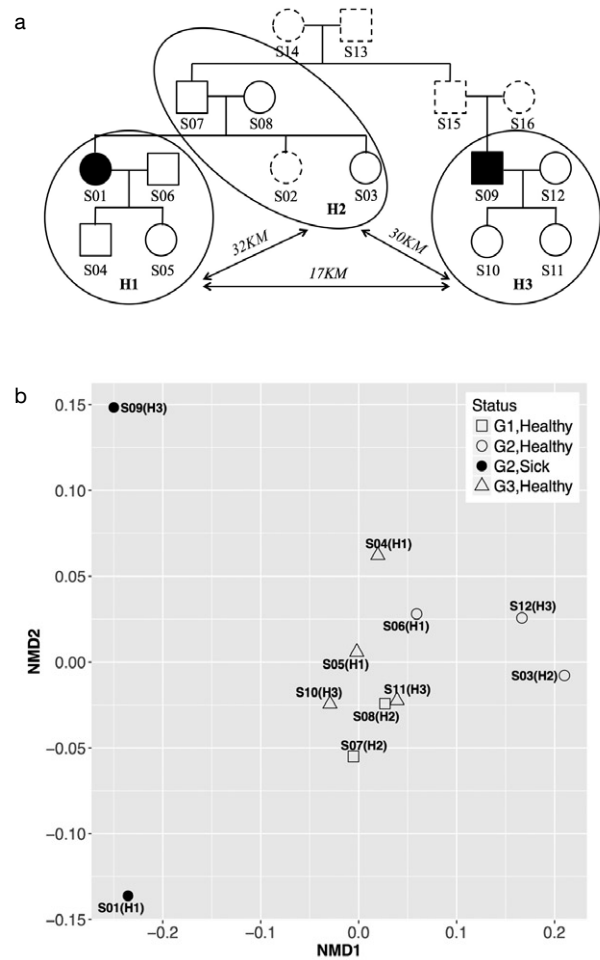

2 | Functional capabilities of microbiomes of CD-affected individuals differ from healthy individuals and from each other. (a) The pedigree of the family in our study. Filled markers indicate CD affected individuals and empty markers are healthy individuals; dashed outline markers indicate individuals not included in this study. Individuals grouped by circles live in the same household. (b) The non-metric multidimensional scaling (NMDS) graph represents the distribution of individual microbiome functional profiles. Samples are labeled with identifiers (S1-S11) and household numbers (H1, H2, or H3, in parenthesis). Legend marker numbers (G1 - grandparents, G2 - parents, G3 - children) represent generations, while marker shapes relate generations and CD status. Sick individuals (filled markers) localize separately from each other and from the cluster of healthy individuals (empty markers).

## Focus Group Integrative Structural Biology

Prof. Carlo Camilloni (TUM) | Rudolf Mößbauer Tenure Track Professor  
Alexander Jussupow (TUM) | Doctoral Candidate

### Scientific Reports



Carlo Camilloni

### © Host

Integrative Structural  
Biology, TUM

Research being conducted by the Focus Group Integrative Structural Biology is centered on the development and application of computational methods to describe the behavior of biological molecules at high resolution. We are interested in enabling the use of computer simulations to provide accurate descriptions of the behavior of proteins and nucleic acids in such a way as to predict the effect of mutations or those resulting from the interactions with other molecules.

We utilize molecular dynamics simulations that are based on models of proteins, nucleic acid and other biological molecules to accomplish our research targets. The group integrates the data resulting from structural biology techniques such as nuclear magnetic resonance (NMR spectroscopy), small angle x-ray scattering (SAXS) and cryo-electron microscopy, making use of techniques derived from information theory and statistics. In this way, we aim at improving the quality of physical models employed in computer simulations to provide robust and quantitative descriptions of biological systems that can be used to rationally design new experiments.

In 2016, our focus was mainly on developing a new theoretical framework in which to integrate equilibrium experimental data into standard physical simulation models. In the past, we worked within the maximum entropy framework: However, this does not allow for a direct inclusion of errors in the experimental data as well as in their interpretation. We have now introduced a more general framework, meta-inference, which is based on Bayesian statistics. It allows for the integration of physical-based models with equilibrium experimental data, and weighting them to take into account possible sources of errors: of notice that this is also equivalent to our former maximum entropy approach when errors are negligible.

Parallel to this, we have applied our methods to develop a better understanding of the role played by protein dynamics in protein folding and aggregation. In particular and in collaboration with John Christodoulou at University College of London (UK), we have studied to which extent the behavior of a nascent protein – a protein being translated by the ribosome – is actually influenced by the ribosome itself. In particular, we have focused our attention on two representative cases: a classical, well-folded protein (a protein with a well-defined 3-D structure); and an intrinsically disordered protein,  $\alpha$ -synuclein, that is involved in Parkinson's disease.

In a separate collaboration with Stefano Ricagno from the University of Milano (Italy) we studied the link between protein dynamics and protein aggregation. The question here was to investigate to which extent the chances for a protein to aggregate into amyloid fibrils, which are responsible for a number of diseases, are determined by the protein's intrinsic thermal stability, i.e. its ability to retain its 3-D structure upon heating. We also explored whether or not there are other properties that can play a critical role in the aggregation processes. By studying  $\beta$ 2-microglobulin, whose aggregation is associated with dialysis-related amyloidosis, we have found that while stability is often a key factor, it is nonetheless possible to design stable protein variants whose aggregation properties are completely independent from thermal stabilities.

1 | Structural ensemble of two  $\beta$ 2-microglobulin variants representing their structure and dynamics. The two variants show a different behavior characterized by two or three representative states and corresponding to different exposure of aggregation prone regions.

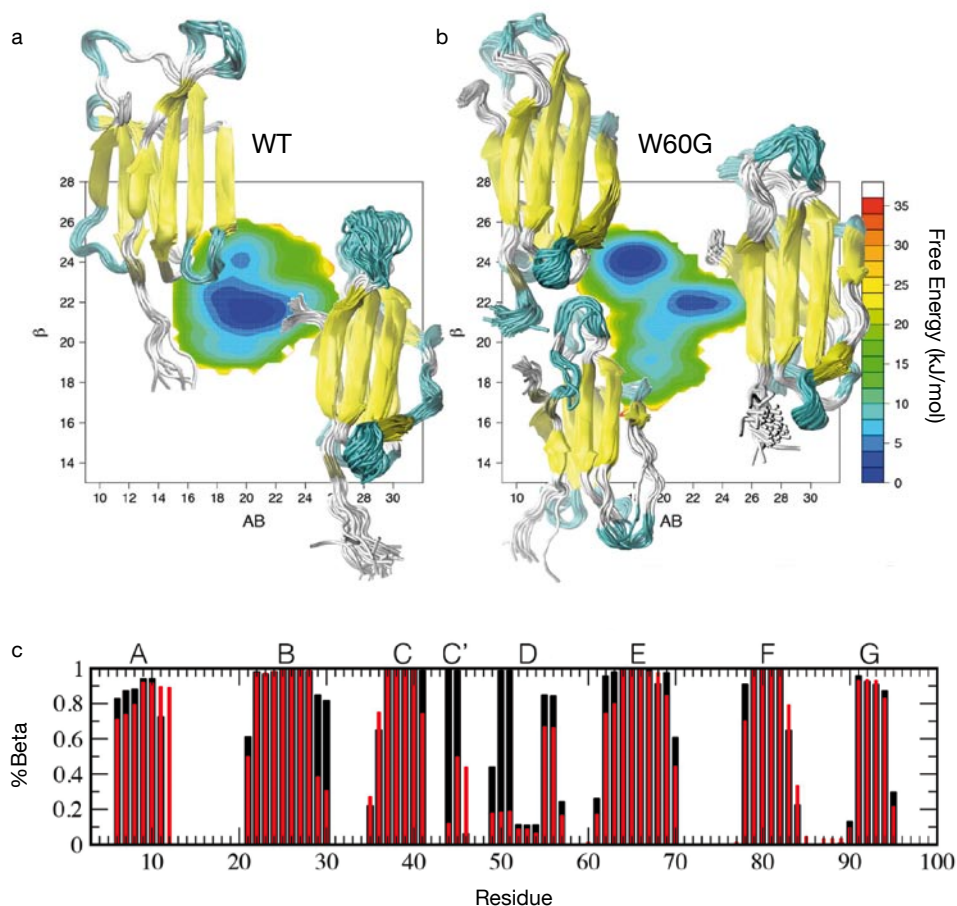

### Selected Publications

- [1] A. Deckert, C. A. Waudby, T. Wlodarski, A. S. Wentink, X. Wang, J. P. Kirkpatrick, J. F. S. Paton, C. Camilloni, P. Kukic, C. M. Dobson, M. Vendruscolo, L. D. Cabrita, and J. Christodoulou, "Structural characterization of the interaction of  $\alpha$ -synuclein nascent chains with the ribosomal surface and trigger factor," *Proc. Natl. Acad. Sci. U.S.A.*, vol. 113, no. 18, pp. 5012–5017, 2016.
- [2] L. D. Cabrita, A. M. E. Cassaignau, H. M. M. Launay, C. A. Waudby, T. Wlodarski, C. Camilloni, M.-E. Karyadi, A. L. Robertson, X. Wang, A. S. Wentink, L. S. Goodsell, C. A. Woolhead, M. Vendruscolo, C. M. Dobson, and J. Christodoulou, "A structural ensemble of a ribosome-nascent chain complex during cotranslational protein folding," *Nat. Struct. Mol. Biol.*, vol. 23, no. 4, pp. 278–285, 2016.
- [3] M. Bonomi, C. Camilloni, A. Cavalli, and M. Vendruscolo, "Metainference: A Bayesian inference method for heterogeneous systems," *Sci. Adv.*, vol. 2, no. 1, p. e1501177, 2016.
- [4] C. Camilloni, B. M. Sala, P. Sormanni, R. Porcari, A. Corazza, M. De Rosa, S. Zanini, A. Barbiroli, G. Esposito, M. Bolognesi, V. Bellotti, M. Vendruscolo, and S. Ricagno, "Rational design of mutations that change the aggregation rate of a protein while maintaining its native structure and stability," *Sci. Rep.*, vol. 6, p. 25559, 2016.

*Publications by this Focus Group can also be found in the section Publications of this report.*

# Focus Group **Biomolecular Design**

Prof. Hendrik Dietz (TUM) | Carl von Linde Senior Fellow

## Scientific Reports



Hendrik Dietz

© Host  
Biomolecular  
Nanotechnology, TUM

We focus on the design of macromolecular structures, currently using mostly nucleic acids, in order to understand the links between the sequence, shape, and function of biomolecules; and to learn what it takes to build artificial molecular machines. We also develop precision measurement methods for analyzing biomolecules and the physical interactions between them with greater detail.

## Molecular engineering with DNA

It is notoriously difficult to observe, let alone control, the position and orientation of molecules due to their small size and the constant thermal fluctuations that they experience in solution. Molecular self-assembly with DNA enables building custom-shaped, nanometer-scale objects with molecular weights up to the mega-dalton regime. It provides an attractive route for placing molecules and constraining their fluctuations in user-defined ways, thereby opening up completely new avenues for scientific and technological exploration. In 2016, our Focus Group made progress with the following aspects:

## High-resolution measurements of biomolecular interactions and structure supported by DNA origami

### Single-molecule dissection of stacking forces in DNA

We directly measured at the single-molecule level the forces and lifetimes of DNA base-pair stacking interactions for all stack sequence combinations. Our experimental approach combined dual-beam optical tweezers with DNA origami components to allow positioning of blunt-end DNA helices so that the weak stacking force could be isolated. Base-pair stack arrays that lacked a covalent backbone connection spontaneously dissociated at average rates ranging from 0.02 to 500 per second, depending on the sequence combination and stack array size. Forces in the range from 2 to 8 piconewtons that act along the helical direction only mildly accelerated the stochastic unstacking process. The free-energy increments per stack that we estimate from the measured forward and backward kinetic rates ranged from  $-0.8$  to  $-3.4$  kilocalories per mole, depending on the sequence combination. Our data contributes to understanding the mechanics of DNA processing in biology, and it is helpful for designing the kinetics of DNA-based nanoscale devices according to user specifications.

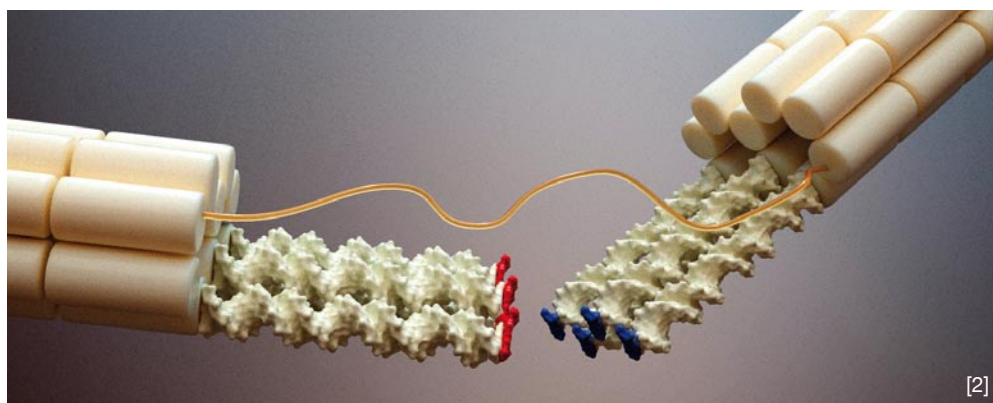



## Uncovering the forces between nucleosomes using DNA origami

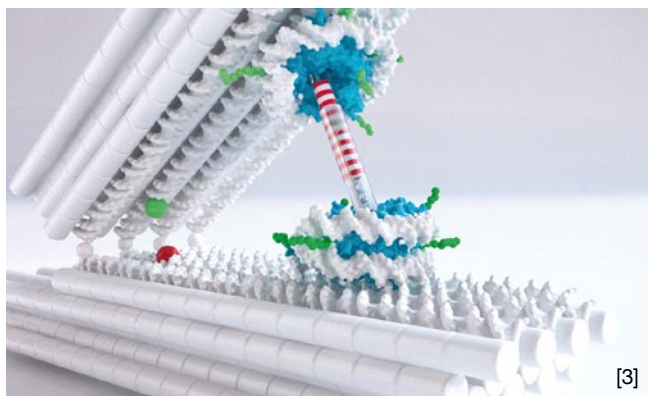

Revealing the energy landscape for nucleosome association may contribute to the understanding of higher-order chromatin structures and their impact on genome regulation. We accomplished this in a direct measurement by integrating two nucleosomes into a DNA origami-based force spectrometer, which enabled subnanometer-resolution measurements of nucleosome-nucleosome distance frequencies via single-particle electron microscopy imaging. From the data, we derived the Boltzmann-weighted, distance-dependent energy landscape for nucleosome pair interactions. We find a shallow but long-range (~6 nm) attractive nucleosome pair potential with a minimum of  $-1.6$  kcal/mol close to direct contact distances. The relative nucleosome orientation had little influence, but histone H4 acetylation or removal of histone tails drastically decreased the interaction strength. Because of the weak and shallow pair potential, higher-order nucleosome assemblies will be compliant and experience dynamic shape fluctuations in the absence of additional cofactors. Our results contribute to a more accurate description of chromatin and our force spectrometer provides a powerful tool for the direct and high-resolution study of molecular interactions using imaging techniques.

## Design of a molecular support for cryo-EM structure determination

119

Despite the recent rapid progress made in cryo-electron microscopy (cryo-EM), there still exist ample opportunities for improvement in sample preparation. Macromolecular complexes may disassociate or adopt non-random orientations against the extended air-water interface that exists for a short time before the sample is frozen. We designed a hollow support structure using 3-D DNA origami to protect complexes from the detrimental effects of cryo-EM sample preparation. For a first proof-of-principle, we concentrated on the transcription factor p53, which binds to specific DNA sequences on double-stranded DNA. The support structures spontaneously form monolayers of pre-oriented particles in a thin film of water, and offer advantages in particle picking and sorting. By controlling the position of the binding sequence on a single helix that spans the hollow support structure, we also sought to control the orientation of individual p53 complexes. Although the latter did not yet yield the desired results, the support structures did provide partial information about the relative orientations of individual p53 complexes. We used this information to calculate a tomographic 3-D reconstruction, and refined this structure to a final resolution of  $\sim 15$  Å. This structure settles an ongoing debate about the symmetry of the p53 tetramer bound to DNA.

## Molecular positioning with atomic accuracy

Molecular self-assembly with nucleic acids relies on building blocks that are commensurate to those of biological macromolecular machines and should therefore be capable of delivering the atomic-scale placement accuracy known today only from natural and designed proteins. However, research in the field has predominantly focused on producing increasingly large and complex – albeit more coarsely defined – objects and placing them in an orderly manner on solid substrates. So far, few objects afford design accuracy better than 5 nm, and the subnanometer scale has been reached only within the unit cells of designed DNA crystals. In this work, we report a molecular positioning device made from a hinged DNA origami object in which the angle between the two structural units can be controlled with adjuster helices. To test the positioning capabilities of the device, we used photo-physical and crosslinking assays that report the coordinate of interest directly with atomic resolution. Using this combination of placement and analysis, we rationally adjusted the average distance between fluorescent molecules and reactive groups from 1.5 to 9 nm in 123 discrete displacement steps. The smallest displacement step possible was 0.04 nm, which is slightly less than the Bohr radius. The fluctuation amplitudes in the distance coordinate were also small ( $\pm 0.5$  nm), and within a factor of two to three of the amplitudes found in protein structures. This study constitutes an important proof-of-concept that lends confidence in the capabilities of molecular self-assembly with nucleic acids.

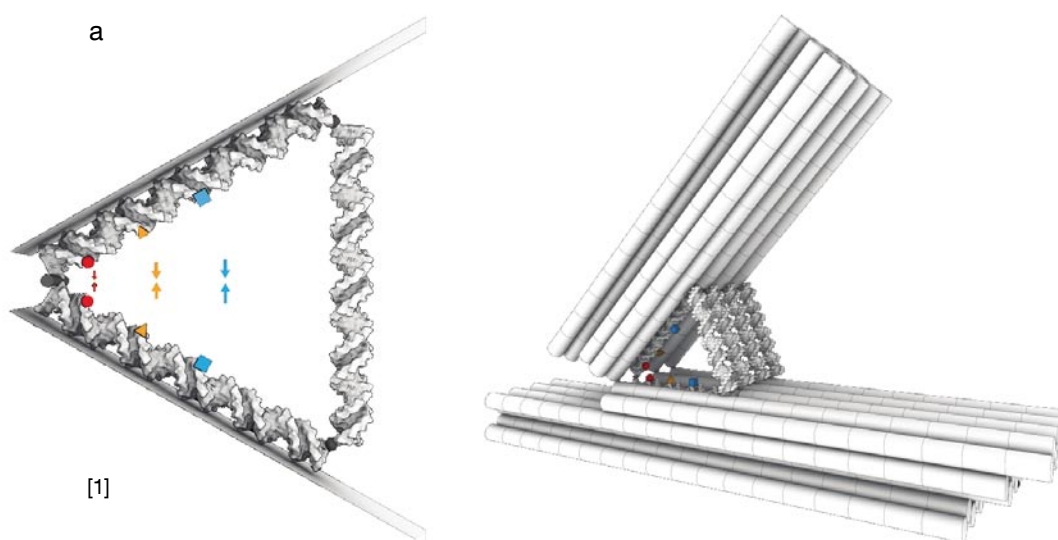

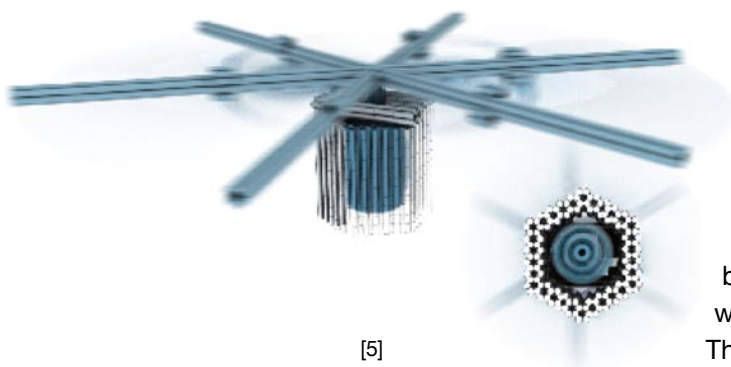

[5]

In our quest towards building molecular machines, we report a nanoscale rotary mechanism that reproduces some of the dynamic properties of biological rotary motors in the absence of an energy source, such as random walks on a circle with dwells at docking sites. Our mechanism is built modularly from tight-fitting components that were self-assembled using multilayer DNA origami. The apparatus has greater structural complexity than previous mechanically interlocked objects and features a well-defined angular degree of freedom without restricting the range of rotation. We studied the dynamics of our mechanism using single-particle experiments analogous to those performed previously with actin-labeled adenosine triphosphate synthases. In our mechanism, rotor mobility, the number of docking sites, and the dwell times at these sites may be controlled through rational design. Our prototype thus realizes a working platform toward creating synthetic nanoscale rotary motors. The assembly methods developed in this study will support creating other complex nanoscale mechanisms based on tightly fitting, sterically constrained, but mobile, DNA components.

### Reference

- [1] J. Funke, and H. Dietz, “Placing molecules with Bohr radius resolution using DNA origami,” *Nat. Nanotechnol.*, vol. 11, no. 1, pp. 47–52, 2015.

### Selected Publications

- [2] F. Kilchherr, C. Wachauf, B. Pelz, M. Rief, M. Zacharias, and H. Dietz, “Single-molecule dissection of stacking forces in DNA,” *Science*, vol. 353, no. 6304, 2016.
- [3] J. Funke, P. Ketterer, C. Lieleg, S. Schunter, P. Korber, and H. Dietz, “Uncovering the forces between nucleosomes using DNA origami,” *Sci. Adv.*, vol.2, no.11, 2016.
- [4] T. Martin, T. Bharat, A. Joerger, X. Bai, F. Praetorius, A. Fersht, H. Dietz, and S. Scheres, “The design of a molecular support for cryo-EM structure determination,” *PNAS*, vol. 113, no. 47, pp. E7456–E7463, 2016.
- [5] P. Ketterer, E. Willner, and H. Dietz, “Nanoscale rotary apparatus formed from tight-fitting 3D DNA components,” *Sci. Adv.*, vol. 2, no. 2, pp. e1501209, 2016.

*Publications by this Focus Group can also be found in the section Publications of this report.*

# Focus Group **Biologically Inspired Material Science**

Prof. Zvonimir Dogic (Brandeis University) | Hans Fischer Senior Fellow  
Felix Keber (TUM) | Doctoral Candidate

## Scientific Reports



Zvonimir Dogic

© Host

Prof. Andreas Bausch  
Molecular and Cellular  
Biophysics, TUM

## Self assembly with DNA origami particles

Over the course of 2016, the Focus Group made substantial progress in the broad area of molecular self-assembly. In particular, Zvonimir Dogic worked together with the Biomolecular Design Focus Group, led by TUM professor, Hendrik Dietz: The target was to demonstrate the many intriguing possibilities that arise once the field of colloidal self-assembly is merged with the rapidly emerging area of DNA origami technology. It has long been recognized that controlling the shape and interactions of colloidal particles should, in principle, allow for the design of novel materials with tunable structural, mechanical and optical properties. However, the main obstacle to progress has been the lack of a rational method for creating complex colloids using traditional synthesis methods. In comparison, DNA origami technology allows for the rapid and robust assembly of particles of arbitrary structural complexity. The Focus Group Biologically Inspired Material Science reported on the powerful synergies that emerge at the intersection between these two fields. Specifically, relying on the unique structural feature of origami particles, the group's work provides fundamentally new insights into self-assembly of bulk liquid crystals and 1-D supramolecular polymers.

Perhaps the most dramatic example of how the shape of constituent particles dramatically changes the fundamental material properties comes from the field of liquid crystals. Within this vast and technologically important research area, the chirality of the constituent molecules is essential for many of the desirable properties of liquid crystals. However, despite its outsized importance, at present there is neither quantitative nor even a qualitative understanding of the relationship between tendency of liquid crystalline materials to adopt macroscopic twist and the microscopic chirality of the constituent units. Specifically, when looking at a particular microscopic chiral structure, theoretical models fail to predict either the magnitude or the handedness of the cholesteric twist. One of the main obstacles to progress in this area has been the inability to continuously tune the chirality of the constituent building blocks. There are many routes towards making chiral or achiral molecules, but continuously tuning the magnitude of any given chiral molecule remains an outstanding problem in supramolecular chemistry. Using the unique features of origami technology, we designed a set of origami filaments in which we directly control the magnitude of the twist that is inscribed along the filament's long axis. We quantitatively showed how such microscopic twist controls the magnitude of the cholesteric pitch. Our data provides essential information that is required for the development of predictive theoretical models of how chirality propagates from microscopic to macroscopic lengthscales in liquid crystalline materials.

Building on these results, in our next step, we used the same filaments to robustly assemble an entirely different structure: twisted chiral ribbons whose length can reach hundreds of microns. For large-wavelength distortions, we showed that these linear assemblages behave as semi-flexible supramolecular polymers with effective bending rigidity that can be extracted from microscopic fluctuations. We demonstrated that structure, chirality and elastic properties of the twisted ribbons can be precisely engineered by tuning the geometry of the constituent filaments. Ranging from misfolded proteins and block copolymers to Gemini surfactants, twisted ribbons and amyloid fibers are a ubiquitous structural motif that has direct relevance to both basic life sciences and human health – while simultaneously holding promise for development of new structural biomaterials. Essentially, all of the above described assembly pathways are driven by the same interactions, namely the hydrophobic segments of the structural building blocks that associate laterally in an aqueous solvent. In the submitted manuscript, we demonstrate a fundamentally different pathway for assembly of 1-D twisted ribbons. This pathway does not rely on the chemical heterogeneity of the building blocks, but rather on the geometry of the elemental units. Since hard-core repulsive interactions that drive assembly of such ribbons are universal, our results should be applicable to all rod-like molecules. Indeed, initial experiments demonstrating the same assembly pathways in two very different systems demonstrate the universal nature of our findings.

The work described above inherently spans many diverse fields within material science, ranging from DNA origami, self-assembly, supramolecular chemistry, biophysics, soft matter and colloidal science.

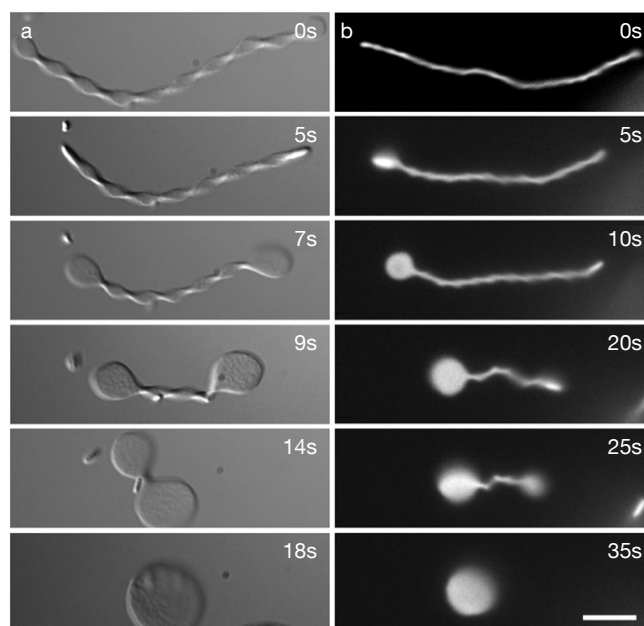

1 | Stimuli induced ribbon to membrane transition.

(a) A sequence of DIC images illustrates polymorphic transition of 1-D ribbons into flat 2-D colloidal membranes. The ribbon is comprised of a monolayer of aligned, rod-like viruses and with increasing temperature undergoes a polymorphic transition.

(b) A similar ribbon-to-membrane transition observed in a suspension of six helix DNA origami filaments. The transition is induced by exposure to fluorescence excitation light. Scale bars, 4  $\mu\text{m}$ .

## Focus Group Cellular Protein Biochemistry

Prof. Matthias J. Feige (TUM) | Rudolf Mößbauer Tenure Track Professor  
Nicolas Blömeke, Joao Coelho, Yonatan Mideksa, Stephanie Müller,  
Susanne Reitberger (TUM) | Doctoral Candidates

### Scientific Reports



Matthias J. Feige

© Host  
Cellular Protein  
Biochemistry, TUM

During the second year at the TUM-IAS, our laboratory for Cellular Protein Biochemistry (CPB lab) has continued to pursue our research agenda of understanding how proteins acquire their native structure in the cell. To accomplish this, we use an interdisciplinary approach that combines biochemical and biophysical approaches with mammalian cell biology.

Proper protein function depends on proteins adopting their correct structure. This process underlies all the biological processes that cells and organisms depend on – from immune defense to memory formation. Within the cell, protein folding is aided by a class of dedicated protein folding helpers, so-called “molecular chaperones,” and proteins that fail to mature properly are targeted for degradation. It is a fundamental question in cell biology and protein biochemistry as to how the machine of cellular protein folding can discriminate between properly folded proteins and those that are misfolded and could potentially give rise to debilitating disorders like Parkinson’s or Alzheimer’s disease.

A study under our participation has now shed some light onto this issue: The machinery that scrutinizes secretory pathway proteins, which are produced in a dedicated organelle of the cell called the endoplasmic reticulum, can be divided into two functional classes of chaperones. One of these classes detects very abundant sequences within proteins that are hydrophobic (e.g., water repellent) in nature, and that simply signify a protein is not completely folded yet. These chaperones aid protein folding reactions. Our work has revealed that a second class of chaperones, however, is specialized in recognizing sequences that could give rise to toxic protein aggregation, and would thus be harmful to the cell and organism as a whole. Once recognized, these proteins are targeted for degradation. This work has been published and highlighted in the journal *Molecular Cell* [1,2].

Current work in the CPB lab is focused on two major topics. First, we are looking at quality control of membrane proteins, in which principles are still mostly unknown, yet are of immediate biomedical relevance. And second, we investigate the biogenesis of interleukins, which are key signaling molecules in our immune system. Understanding interleukin biogenesis in the cell in more detail will provide an avenue towards rationally optimizing these key immune molecules, and will pave the way for the development of novel approaches to immunomodulation.

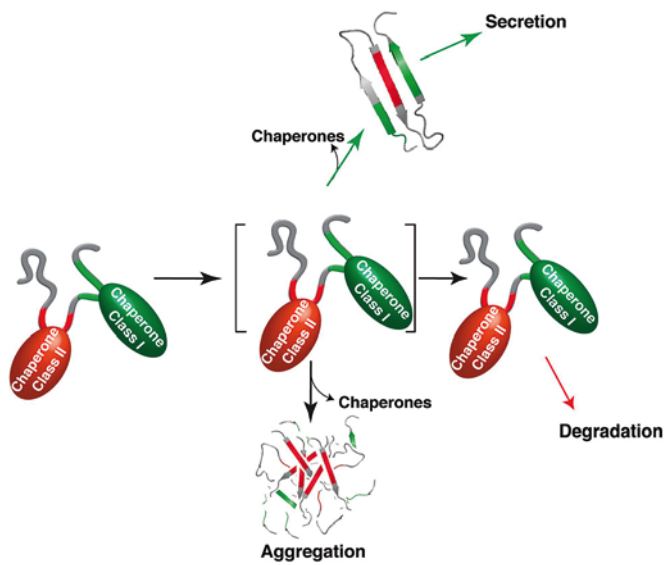

1 | Two distinct chaperone classes exist within the cell's endoplasmic reticulum to scrutinize proteins before they leave the cell [2].

## Reference

- [1] D. N. Hebert, E. M. Clerico, and L. M. Gierasch, "Division of labor: ER-resident BiP co-chaperones match substrates to fates based on specific binding sequences," *Mol. Cell*, vol. 63, no. 5, pp. 721–723, 2016.



2 | An artistic representation of protein quality control in the cell. Copyright: Joshua Stokes, St. Jude Children's Research Hospital, USA.

## Selected Publication

- [2] J. Behnke, M. J. Mann, F. L. Scruggs, M. J. Feige, and L. M. Hendershot, "Members of the Hsp70 family recognize distinct types of sequences to execute ER quality control," *Mol. Cell*, vol. 63, no. 5, pp. 739–752, 2016.

*Publications by this Focus Group can also be found in the section Publications of this report.*

## Focus Group Structural Membrane Biochemistry

Prof. Franz Hagn (TUM) | Rudolf Mößbauer Tenure Track Professor  
Dr. Kai Fredriksson, Dr. Shakeel A. Shahid (TUM) | Postdoctoral Researchers  
Laura Entenmann, David Goricanec, Elisabeth Häusler, Kolio Raltchev,  
Andrea Steiner (TUM and HMGU) | Doctoral Candidates

Scientific Reports

### Design of novel circular nanodiscs for membrane protein structural biology



Franz Hagn

© Host  
Structural Membrane  
Biochemistry, TUM

The research of the Focus Group Structural Membrane Biochemistry is concentrated on nuclear magnetic resonance (NMR) spectroscopy, but also on a variety of other biophysical and biochemical methods. We are interested in the mechanism and the mode of action of membrane protein systems connected to cancer, neurological disorders and metabolic diseases. For many of these pharmaceutically relevant membrane protein systems, molecular and structural details are either sparse or absent. In order to obtain high quality structural data, we are employing cutting-edge biochemical methods for membrane protein sample preparation, using various membrane mimetics such as detergent micelles, detergent-lipid bicelles and phospholipid nanodiscs. The latter is a novel detergent-free and native-like membrane system. This system has recently been optimized in the lab to enable structure determination by NMR and electron microscopy [1]. More recently, we established a protocol for high-resolution structure determination of membrane proteins in nanodiscs. A combination of specific isotope labeling and suitable NMR methods yielded the first protein side chain-based structure of a membrane protein in nanodiscs [3]. To produce otherwise elusive eukaryotic membrane proteins, we are employing cell-free protein expression, and have adapted this method for the production of selectively labeled membrane proteins that could not be obtained in living cells and were able to record high-resolution NMR data [2].

Among recent results in G-protein [4] and tumor suppressor protein [5] structural biology, one major achievement in 2016 was the development of novel phospholipid nanodiscs for structural studies of membrane proteins using NMR and electron microscopy [6]. The membrane scaffold protein (MSP), encircling a patch of phospholipid bilayer to form nanodiscs, has been produced in a circular form by using the enzyme SortaseA. This enzyme ligates an N-terminal glycine residue to a specific SortaseA recognition site. These two motifs have been inserted into one MSP molecule, thus enabling efficient intramolecular circularization at low protein concentrations. The resulting nanodiscs show extremely narrow size distributions as compared to nanodiscs formed with linear MSP. This feature is perfectly suited for high-resolution EM studies of membrane proteins. Due to the almost identical size of these nanodiscs, the generation of EM class averages is possible, thus enabling efficient structure determination using single particle EM. Furthermore, the covalent nature of this system is suitable to trap defined oligomeric states of a membrane protein. This can be exploited in NMR spectroscopy, where circular nanodiscs of different sizes can be used to trap the oligomeric and the monomeric state of a membrane protein and compare the NMR spectra obtained in each case to map oligomerization surfaces of membrane proteins.

In summary, this novel nanodisc system will be of use for a large variety of NMR and EM applications with membrane proteins. Our Focus Group will continue working on nanodisc development and the application of this technology to biomedically relevant membrane protein systems such as G-protein coupled receptors and mitochondrial membrane proteins.



## References

- [1] F. Hagn, M. Etzkorn, T. Raschle, and G. Wagner, "Optimized phospholipid bilayer nanodiscs facilitate high-resolution structure determination of membrane proteins," *J. Am. Chem. Soc.*, vol. 135, no. 5, pp. 1919–1925, 2013.
- [2] R. Linser, V. Gelev, F. Hagn, H. Arthanari, S. G. Hyberts, and G. Wagner, "Selective methyl labeling of eukaryotic membrane proteins using cell-free expression," *J. Am. Chem. Soc.*, vol. 136, no. 32, pp. 11308–11310, 2014.
- [3] F. Hagn and G. Wagner, "Structure refinement and membrane positioning of selectively labeled OmpX in phospholipid nanodiscs," *J. Biomol. NMR*, vol. 61, no. 3, pp. 249–260, 2015.

## Selected Publications

- [4] D. Goricanec, R. Stehle, P. Egloff, S. Grigoriu, A. Plückthun, G. Wagner, and F. Hagn, "Conformational dynamics of a G-protein  $\alpha$  subunit is tightly regulated by nucleotide binding," *Proc. Natl. Acad. Sci. U.S.A.*, vol. 113, no. 26, pp. E3629–E3638, 2016.
- [5] A. Enthart, C. Klein, A. Dehner, M. Coles, G. Gemmecker, H. Kessler, and F. Hagn, "Solution structure and binding specificity of the p63 DNA binding domain," *Sci. Rep.*, vol. 6, p. 26707, 2016.
- [6] M. L. Nasr, D. Baptista, M. Strauss, Z. J. Sun, S. Grigoriu, S. Huser, A. Plückthun, F. Hagn, T. Walz, J. M. Hogle, and G. Wagner, "Covalently circularized nanodiscs for studying membrane proteins and viral entry," *Nat. Methods*, vol. 14, no. 1, pp. 49–52, 2017, accepted in 2016.

*Publications by this Focus Group can also be found in the section Publications of this report.*

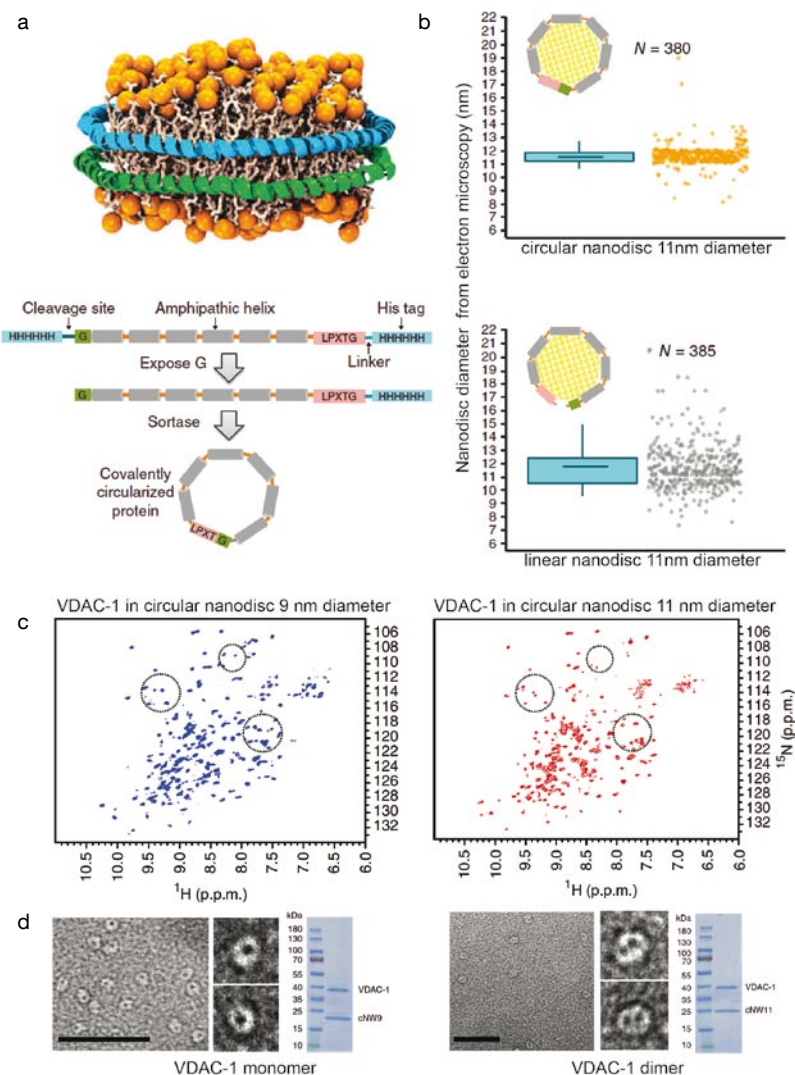

**1 | Design and application of circular membrane scaffold proteins for electron microscopy (EM) and NMR applications.** (a) Model of a phospholipid nanodisc, consisting of a patch of lipids surrounded by two copies of membrane scaffold protein (MSP). Below: Sortase-mediated circularization of MSP. (b) Negative-stain EM of nanodiscs formed with linear (top) and circular (bottom) MSP. Circular MSP leads in a narrow size distribution of the resulting nanodiscs, rendering this system suitable for high-resolution (cryo-) EM studies of membrane proteins. (c) and (d) Circular nanodiscs can be used to trap different oligomeric states of the VDAC1 anion channel, as probed with 2D-[ $^{15}\text{N}$ ,  $^1\text{H}$ ]-TROSY experiments (cNW9: 9 nm diameter, cNW11: 11 nm diameter) (c), and negative-stain EM (d). This system can thus be used to map the interfaces of oligomeric membrane proteins using NMR chemical shift perturbations.

# Focus Group Population Epigenetics and Epigenomics

Prof. Frank Johannes (TUM) | Rudolf Mößbauer Tenure Track Professor  
Dr. David Roquis, Dr. Amaryllis Vidali (TUM) | Postdoctoral Researchers

## Scientific Reports



Frank Johannes

## © Host

Population Epigenetics  
and Epigenomics, TUM

DNA functionally interacts with a variety of epigenetic marks, such as cytosine methylation or histone modifications (figure 1a). The dynamic placement of these marks along the genome is essential for coordinating gene expression programs, and for maintaining genome integrity in response to developmental or environmental cues. Technological advances in the past decade have enabled high-resolution measurements of various epigenetic marks at a genome-wide scale (figure 1b). The computational integration of these measurements has led to the construction of so-called chromatin state maps (figure 1c), which provide an operational definition for the term “epigenome.” These integrated maps are believed to provide a good description of the functional state of the genome in a given cell type and at a specific point in time.

Large initiatives are currently underway to collect reference epigenomes for different tissues, developmental stages, disease states and environmental treatments. Reference epigenomes are usually derived from cells extracted from single individual or a pool of several individuals, and therefore do not capture inter-individual epigenomic variation at the population level. Genetic polymorphisms or differential environmental exposure can alter chromatin states and lead to transient or permanent changes in gene expression. Chromatin states therefore represent important molecular phenotypes that mediate how different genotypes are translated into observable traits, or how environmental signals are translated into genomic function. There is substantial interest within the biomedical, agricultural and evolutionary communities to try to understand the factors that cause population epigenomic variation. A number of recent genetic studies have tried to quantify the heritable basis underlying population epigenomic variation, and to delineate its regulatory genetic architecture (figure 1d). New insights and results from these population-level genetic studies are accumulating at a staggering pace. In 2016, the TUM-IAS Focus Group Population Epigenetics and Epigenomics published a comprehensive, up-to-date summary of and perspective on these recent developments [1].

Unlike in mammalian systems such as humans, plants can transmit changes in epigenetic marks to subsequent generations. Epigenetic modifications have therefore emerged as potentially important factors in plant evolution, and as possible molecular targets for the improvement of commercial crops. One epigenetic mark in plants that has been studied intensively is cytosine methylation, a chemical modification of a cytosine into 5-methylcytosine. Despite major progress in dissecting the molecular pathways that control cytosine methylation patterns in plants, little is known about the mechanisms that shape plant methylomes over evolutionary time. Drawing on recent intra- and intra-specific data, our group showed that long-term methylome evolution appears to mainly be a by-product of genomic changes, such as the differential expansion of transposable elements and repeat sequences as well as genetic mutations in pathways that control DNA methylation or transcriptional states [2]. By contrast, short-term methylome evolution seems to be strongly dominated by heritable stochastic changes in DNA methylation (i.e., epimutations) that occur at relatively high rates, and which are largely independent of genomic backgrounds. Because these two processes operate on different timescales, an obvious empirical goal is to be able to delineate their relative contributions to inter- and intra-specific methylome diversity patterns.

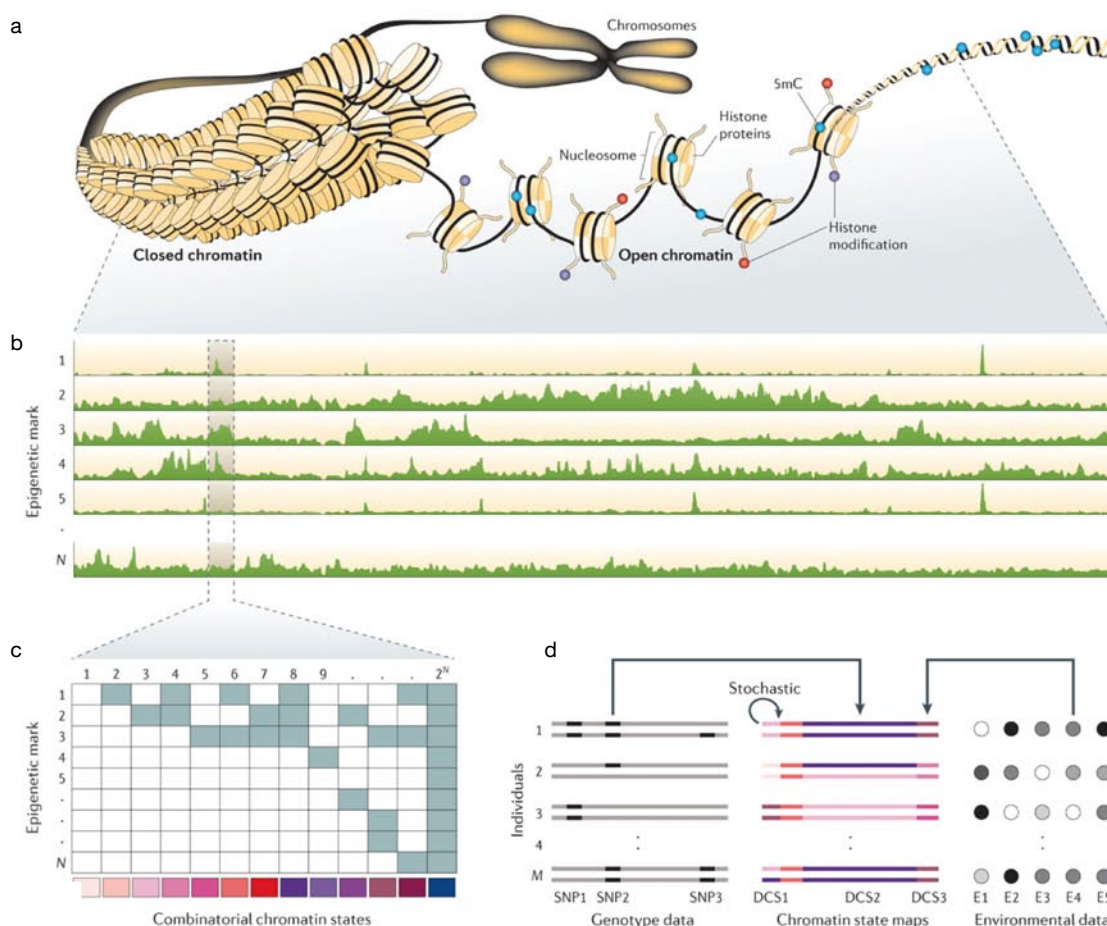

Nature Reviews | Genetics

1 | (a) DNA is tightly packaged in cells and is functionally modified by a variety of epigenetic marks, such as cytosine methylation (5mC) or post-translational changes in histone proteins. The co-occurrence of specific epigenetic marks in a genomic region defines its functional state. Of note, histones in closed chromatin also contain repressive marks (not shown). (b) The genome-wide distribution of different epigenetic marks can be measured using next-generation sequencing (NGS) technologies. Shown here are the read-tracks from NGS measurements of  $N$  different epigenetic marks along the genome. (c) The computational challenge is to infer distinct chromatin states for each genomic position. These chromatin states are defined by the joint presence and absence patterns of the different epigenetic marks. With  $N$  marks there can be  $2^N$  possible combinatorial states. The color code on the bottom denotes each unique state. This analysis leads to the construction of chromatin state maps. (d) Shown are the chromatin state maps of  $M$  diploid individuals. Individuals differ in their chromatin states in three genomic regions. These differential chromatin states (DCSs) can originate from DNA sequence polymorphisms, environmental factors or from stochastic changes. DCS2 is caused by a single-nucleotide polymorphism (SNP2), DCS3 is caused by exposure to environmental factor E4 and DCS1 is the result of stochastic processes in the mitotic maintenance of the chromatin state at that locus. The statistical challenge is to try to identify these causal factors from millions of measured SNPs and a large number of environmental factors [1].

We have provided a proof-of-principle demonstration in the model plant *A. thaliana* showing that a formal analysis of the species' methylation site frequency spectrum (mSFS) in terms of epimutational processes provides a powerful framework for addressing this challenge [2]. We have argued that further applications of such modeling approaches, in conjunction with high-throughput sequencing data, will be necessary to understand the forces that shape the evolution of plant methylomes over timescales that are of agricultural and evolutionary relevance.

#### Selected Publications

- [1] A. Taudt, M. Colome-Tatche, and F. Johannes, "Genetic sources of population epigenomic variation," *Nat. Rev. Genet.*, vol. 17, no. 6, pp 319–332, 2016.
- [2] A. Vidali, D. Živković, R. Wardenaar, D. Roquis, A. Tellier, and F. Johannes, "Methylome evolution in plants," *Genome Biol.*, vol. 17, no. 264, 2016.

*Publications by this Focus Group can also be found in the section Publications of this report.*

### Scientific Reports



Horst Kessler

© Host  
Chemistry, TUM

In 2016 we published 15 manuscripts, with a total impact factor of 99,3. Two highlights are outlined briefly below.

### Developing highly selective and active ligands for integrins: Applications for nuclear imaging coating of biomaterials and biophysical studies

Integrins are bidirectional receptors on cell surfaces which are required in all higher organisms for communications between cells of different tissues and organization of shape, function and integrity of organs. This is why integrins play an important role in biological processes such as embryogenesis, regulation of hemostasis and other functions. The malfunction of integrins is associated with a number of diseases, especially in cancer proliferation and the formation of metastases. In mammals, 24 integrin subtypes are known to be differing temporal and spatial distribution and distinct function. Integrins are heterodimers – one  $\alpha$ - and one  $\beta$ -subunit – which differ in their amino acid composition. Receptor subtypes such as these subtypes of the integrin family have evolved in nature using the same mechanistic principles for different function. The interaction of integrins with proteins in the extracellular matrix is followed by enhanced adhesion and / or signal transduction in the integrin-carrying cells. For medicinal applications, it is of the utmost interest to develop compounds which selectively address those integrin receptor subtypes. Ligands, which are compounds that bind to integrin subtypes, can be modified to attach positron-emitting radioisotopes, and are used to identify and characterize cancers in mice and humans. One of the main problems in cancer treatment targeting integrins is the different expression of integrin subtypes in different cancer populations. Using positron emission tomography (PET), the distinct integrin patterns of a cancer can be determined. Hence, this technology paves the way for a selective treatment, tailored for the individual cancer, so called “Personalized Medicine”.

Over the past year, our group has continued its work on the development of subtype selective ligands to differentiate the RGD-recognizing integrins. The tripeptide sequence Arg-Gly-Asp (RGD) is recognized by eight different integrin subtypes, containing different  $\alpha$ - and  $\beta$ -units in integrins, among them  $\alpha_v\beta_3$ ,  $\alpha_v\beta_6$ ,  $\alpha_v\beta_8$ ,  $\alpha_5\beta_1$  and  $\alpha_{IIb}\beta_3$ . We have been able to design and prepare ligands to differentiate closely related integrins  $\alpha_v\beta_3$  and  $\alpha_5\beta_1$  and functionalize them with Ga-68 or F18, ideal nuclei for PET (in collaboration with Hans-Jürgen Wester and Johannes Notni (Pharmaceutical Radiochemistry, TUM) and Markus Schwaiger (Nuclear Medicine, university hospital Klinikum rechts der Isar)).

The ligands are also used to elucidate the different roles of these integrins in biophysical studies (in collaboration with Joachim Spatz, Max Planck Institute for Intelligent Systems, Stuttgart, Germany) and for the properties of coated biomaterials (in collaboration with Carles Mas-Moruno, BarcelonaTech, Spain). Another integrin which plays a very important role in cancer is the subtype  $\alpha_v\beta_6$ . The ligand we developed – a N-methylated cyclic nonapeptide – allowed the characterization and imaging of cancer in mice which express this specific integrin in high amounts (figure 1).

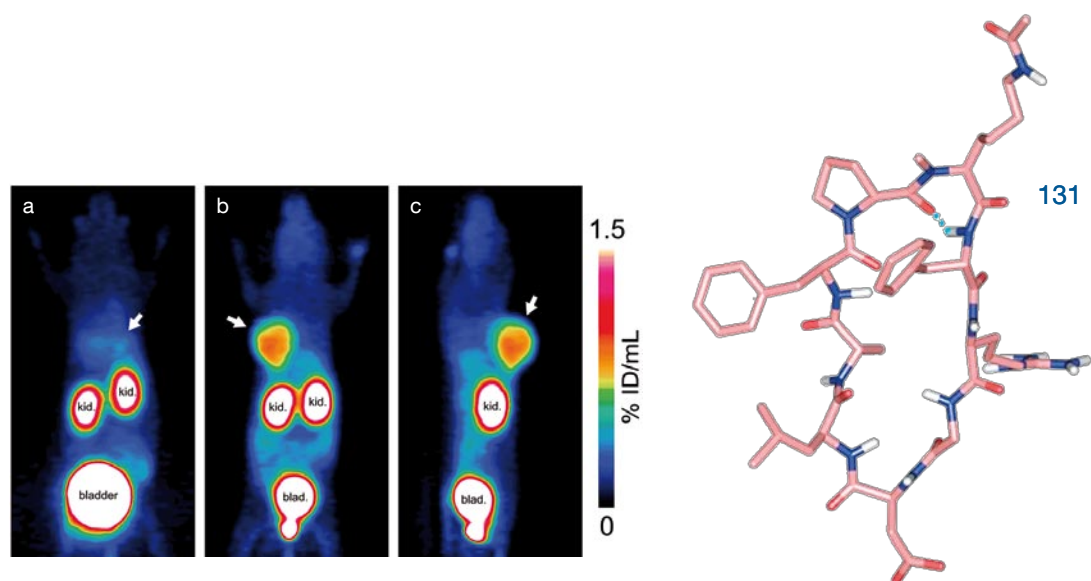

1 | Left:  $^{68}\text{Ga}$ -Avebehexin-PET images (maximum intensity projections, 60 min p.i.) of two different H2009-bearing SCID mice, one with (a) and one without co-injection of 60 nmol Avebehexin (b), dorsal view and (c), sagittal view; 12 MBq, 53 pmol, 230 MBq/nmol. H2009 tumor positions are indicated by white arrows. Right: Structure of the ligand, which is modified with the TRAP unit on the Lysine residue (upper left residue).

*This work was conducted in cooperation with postdoctoral researchers Tobias Kapp, Andreas Räder, and Florian Reichart as well as doctoral candidate Michael Weinmüller (all TUM).*

#### Selected Publications

- [1] O. V. Maltsev, U. Kiran Marelli, T. G. Kapp, F. S. Di Leva, S. Di Maro, M. Nieberler, U. Reuning, M. Schwaiger, E. Novellino, L. Marinelli, and H. Kessler, "Stable peptides instead of stapled peptides: Highly potent  $\alpha_v\beta_6$ -selective integrin ligands," *Angew. Chem., Int. Ed.*, vol. 55, no. 4, pp. 1535–1538, 2016.
- [2] J. Notni, K. Steiger, F. Hoffmann, D. Reich, T. G. Kapp, F. Rechenmacher, S. Neubauer, H. Kessler, and H.-J. Wester, "A match made in heaven: Complementary, selective PET-imaging of integrin subtypes  $\alpha_5\beta_1$  and  $\alpha_v\beta_3$  using Ga-68-Aquibepirin and Ga-68-Avebetrin," *J. Nucl. Med.*, vol. 57, no. 3, pp. 460–466, 2016.
- [3] J. Notni, D. Reich, O. V. Maltsev, T. G. Kapp, K. Steiger, F. Hoffmann, V. Stiegler, I. Esposito, W. Weichert, H. Kessler, and H.-J. Wester, "*In vivo* PET imaging of the 'cancer integrin'  $\alpha_v\beta_6$  using gallium-68 labelled cyclic RGD nonapeptides," *J. Nucl. Med.*, vol. 58, 2017, accepted in 2016.
- [4] C. Mas-Moruno, R. Fraioli, F. Rechenmacher, S. Neubauer, T. G. Kapp, and H. Kessler, " $\alpha_v\beta_3$ - or  $\alpha_5\beta_1$ -integrin-selective peptidomimetics for surface coating," *Angew. Chem., Int. Ed.*, 2016, vol. 55, no. 25, 7048–7068, 2016.
- [5] D. Missirlis, T. Haraszti, C.v.C. Scheele, T. Wiegand, C. Diaz, S. Neubauer, F. Rechenmacher, H. Kessler, and J. P. Spatz, "Substrate engagement of integrins  $\alpha_5\beta_1$  and  $\alpha_v\beta_3$  is necessary, but not sufficient, for high directional persistence in migration on fibronectin," *Sci. Rep.*, vol. 6, p. 23258–23258, 2016.
- [6] V. Schaufler, H. Czichos-Medda, V. Hirschfeld-Warnecken, S. Neubauer, F. Rechenmacher, R. Medda, H. Kessler, B. Geiger, J. P. Spatz, and E. A. Cavalcanti-Adam, "Selective binding and lateral clustering of  $\alpha_5\beta_1$  and  $\alpha_v\beta_3$  integrins: unraveling the spatial requirements for cell spreading and focal adhesion assembly," *Cell Adh. Migr.*, vol. 10, no. 5, pp. 505–515, 2016.

*Publications by this Focus Group can also be found in the section Publications of this report.*

# Focus Group **Physics with Effective Field Theories**

Dr. Andreas S. Kronfeld (Fermilab) | Hans Fischer Senior Fellow  
Dr. Javad Komijani | Postdoctoral Researcher

Scientific Reports



Andreas S. Kronfeld

© Host

[Prof. Nora Brambilla](#)  
Theoretical Particle and  
Nuclear Physics, TUM

## Puzzles surrounding the strong interactions

The main aim of elementary particle physics is to study fundamental interactions at the smallest distance scales, but the interpretation of experiments inevitably demands theoretical control over several length scales. A vital example lies in the search for new, as-yet-unobserved interactions of quarks, which are the underlying building blocks of protons, neutrons, and many other particles known as *hadrons*. The strong nuclear force confines quarks into hadrons before they can be detected. Thus, whenever quarks are involved, it is crucial to understand physics at the distance scale of the proton radius and to examine physics at the microscopic frontier, at a size of at least 1,000 times smaller than the proton.

An analogy for the way theoretical physicists treat such problems is a nest of Russian dolls. Open one up, and you find another one inside. The dolls in this case are *quantum field theories*: the mathematics for every particle is a quantum field – a concept that merges classical field theory and quantum mechanics. Nesting quantum field theories, à la Russian dolls, is known as *effective field theory*, which is one of the central research elements for our Focus Group. The other central element in our research is lattice gauge theory, which sets up quantum fields on a space-time lattice. Especially pertinent is the *lattice gauge theory* of the strong force, quantum chromodynamics (QCD). Lattice QCD allows large-scale computations of QCD dynamics, which are needed to connect the intriguing world of quarks with the detectable world of hadrons.

During the second year of this Focus Group in 2016, we published several papers combining the techniques of effective field theory and lattice QCD. We highlight three papers here: The first paper of the TUMQCD Collaboration [1]; an application of effective field theory to understand *CP* violation of Majorana neutrinos [2]; and a further development of work from 2015 that reveals hints of particle physics beyond the Standard Model in flavor-changing neutral currents.

The accelerator laboratories at CERN (Switzerland) and Brookhaven National Laboratory (USA) recreate the conditions that existed microseconds after the Big Bang occurred via heavy-ion collisions. At this very early time in the universe, hadronic matter existed in a phase known as the quark-gluon plasma. This phase is odd in many ways: for example, the quark-gluon plasma seems to behave like a liquid, but cools to a gas. Instead of being confined inside hadrons, the quarks and gluons propagate in a deconfined way. To gain a better understanding of the quark-gluon plasma, the TUMQCD Collaboration deployed lattice-QCD computer simulations [1]. We inserted test charges into the thermal background of the strong interactions and varied the temperature. We obtained the free energy and the entropy of the test charges, showing that the deconfinement transition takes place at a temperature of about  $1.75 \times 10^{12}$  Kelvin.

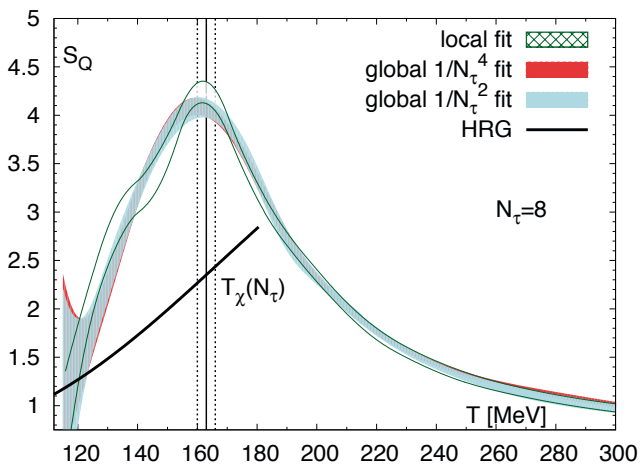

1 | Lattice-QCD calculation of the entropy of a static quark vs. temperature (blue band) showing that the hadron resonance gas (HRG, black curve) does not describe the phase transition [1].

This result from the TUMQCD collaboration suggests that the phase transition, between the quark-gluon plasma and normal hadronic matter, takes place over a significantly narrower range of temperatures than previously thought. Through studies of the high temperature region, we showed that the quark-gluon plasma appears to be weakly interacting at temperatures above  $3.5 \times 10^{13}$  Kelvin [1]. We will pursue these findings further with a grant of computer time on the SuperMUC supercomputer at the Leibniz Supercomputing Centre (Garching).

Javad Komijani and Andreas Kronfeld are joining TUMQCD to pursue this work, which will also yield an improvement on our determination of the basic measure of the strong force, denoted  $\alpha_s$ .

One of the most important open questions in particle physics and cosmology is the origin of the matter-antimatter asymmetry. This can arise when the product  $CP$  of charge conjugation ( $C$ ) and spatial inversion ( $P$ ) is no longer a good symmetry. We have built an effective field theory for a variety of neutrino that is its own antiparticle, known as Majorana after the first person to consider them. If the Majorana neutrino is heavy, there was

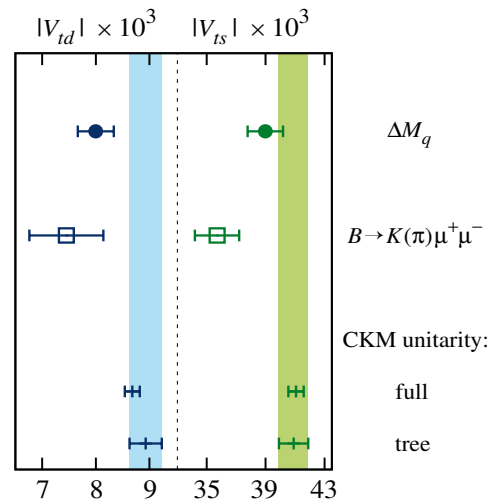

2 | Comparison of B-meson mixing, flavor changing decays  $B \rightarrow K(\pi)ll$ , and several simpler processes (bars) [3]. The deviation of the first two from the bar is a hint of phenomena not captured in the Standard Model of particle physics.

an epoch in the evolution of the early universe when the temperature was below the mass of the Majorana neutrinos, but still larger than the electroweak scale. For this interesting epoch, we have used our effective field theory to calculate the neutrinos' thermal width and  $CP$  asymmetries in lepton decays [2]. These results are the key ingredients in the rate equations of the leptogenesis mechanism for the matter-antimatter asymmetry in today's universe. Standard electroweak interactions could convert the consequent excess of leptons into an excess of baryons (e.g., the protons and neutrons in atomic nuclei) – the most familiar present-day outcome of matter-antimatter asymmetry.

In the 2015 TUM-IAS Annual Report, our group reported on work that revealed a tantalizing puzzle when comparing measurements from the LHCb experiment with calculations of the Standard Model (of particle physics). LHCb measures rare decay rates of B mesons, which must be calculated with lattice QCD. When these decays change the flavor of the quarks without changing the charge, the measured decay rate is smaller than expected. Another process that changes flavor but not charge is “mixing” in which the neutral  $B$  meson changes into its antiparticle and back.

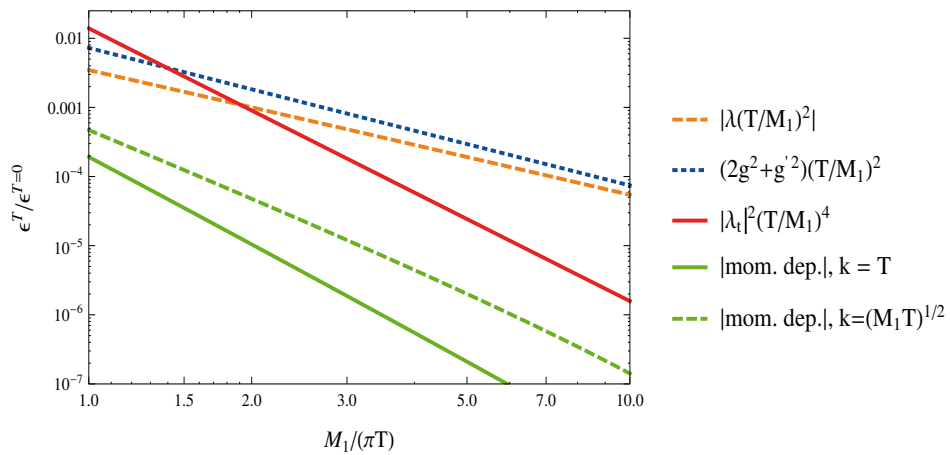

3 | Thermal corrections to the CP asymmetry of a Majorana neutrino decaying into leptons and anti-leptons vs. temperature [2]. The blue, orange, and green curves denote contributions from gauge bosons, from the Higgs boson (times  $-1$ ), and the neutrino momentum (times  $-1$ ).

In the past year, we improved the precision on the QCD ingredients needed to calculate the mixing rate in the Standard Model [3]. We again find that the measured frequency of mixing is smaller than expected. It will be important to confirm these findings: if they hold up with more data and more computer time, they would imply virtual particles lying beyond the known particles of the Standard Model.

In May 2016, our Focus Group hosted the “International Symposium on Effective Field Theories and Lattice Gauge Theory,” bringing researchers from around the world to the TUM-IAS. This successful event is described in detail on page 24 of this report.

*For its project, this Focus Group collaborates with postdoctoral researcher Johannes Weber (Theoretical Particle and Nuclear Physics, TUM) and senior researcher PD Antonio Vairo (Applied Quantum Field Theory, TUM).*

#### Selected Publications

- [1] A. Bazavov, N. Brambilla, H.-T. Ding, P. Petreczky, H.-P. Schadler, A. Vairo, and J. H. Weber, “Polyakov loop in 2+1 flavor QCD from low to high temperatures,” *Phys. Rev. D*, vol. 93, no. 11, art. 114502, 2016.
- [2] S. Biondini, N. Brambilla, and A. Vairo, “CP properties of heavy Majorana neutrinos at finite temperature: the hierarchical case,” *J. High En. Phys.*, vol. 1609, art. 126, 2016.
- [3] A. Bazavov, A. S. Kronfeld, et al., “ $B^0$ -mixing matrix elements from lattice QCD for the Standard Model and beyond,” *Phys. Rev. D*, vol. 93, no.11, art. 113016, 2016.

*Publications by this Focus Group can also be found in the section Publications of this report.*



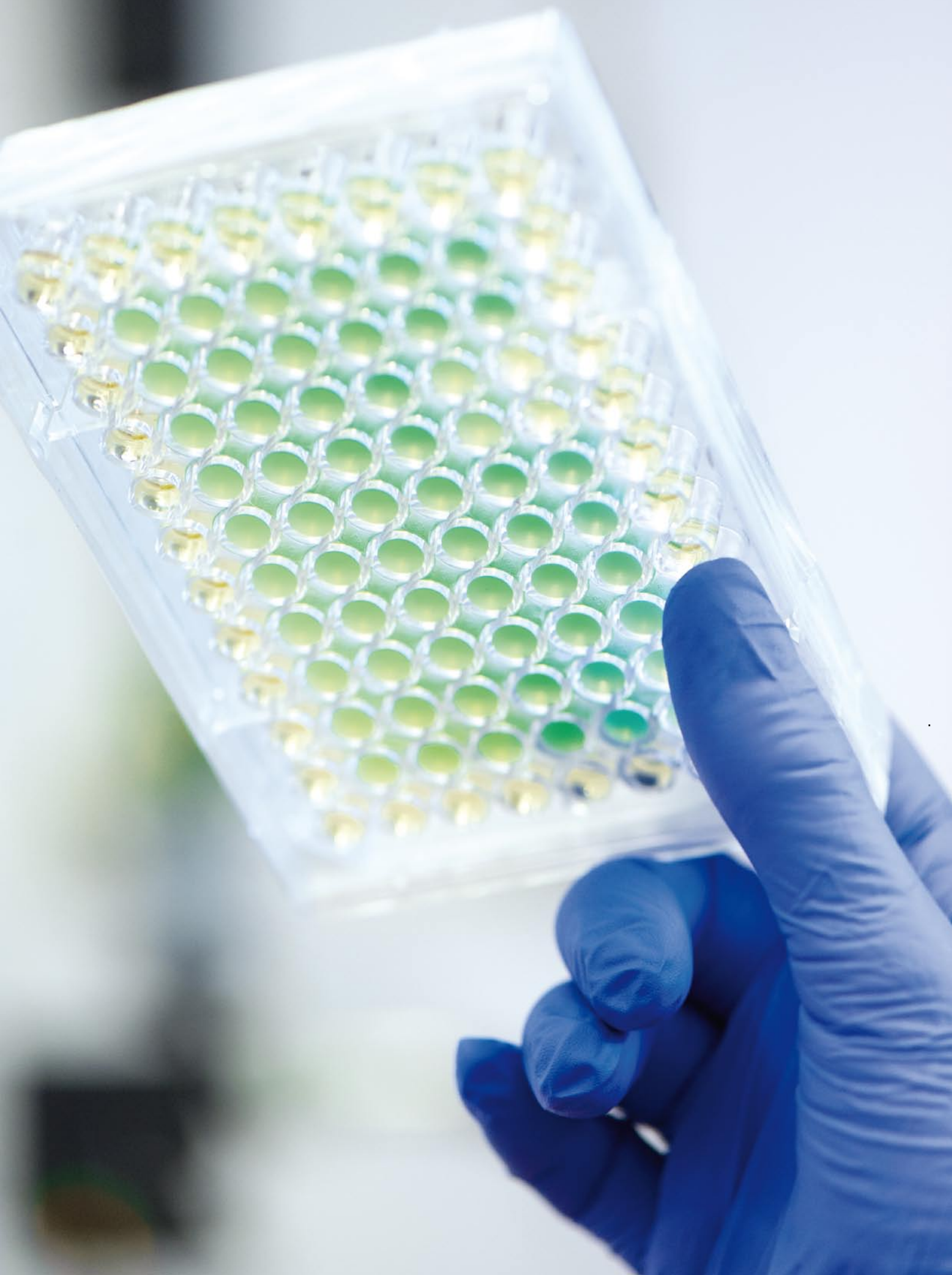

## Focus Group Synthetic Biochemistry

Prof. Kathrin Lang (TUM) | Rudolf Mößbauer Tenure Track Professor

Marko Cigler, Maximilian Fottner, Susanne Mayer,

Marie-Kristin von Wrisberg, (TUM) | Doctoral Candidates

Andreas-David Brunner, Daniel Horn-Ghetko (TUM) | Research Assistants

Scientific Reports

### Expanding the genetic code – chemistry in living systems



Kathrin Lang

© Host

Synthetic Biochemistry

TUM

The Focus Group Synthetic Biochemistry conducts research in the interdisciplinary area of chemical biology, applying concepts from organic chemistry to develop new tools for studying and manipulating complex biological systems.

In particular, we develop and apply approaches that allow the site-specific incorporation of unnatural amino acids (UAAs) with tailored physical and chemical properties into proteins in diverse cells and organisms by genetic code expansion. This can be achieved by using an expanded machinery of translation, consisting of an “orthogonal” aminoacyl-tRNA synthetase (aaRS) / tRNA pair that directs the incorporation of an unnatural amino acid in response to an amber stop codon (UAG) placed at a user-defined site in a gene of interest (amber suppression, figure 1). By incorporating new UAAs bearing different functional moieties, it has been possible to leverage genetic code expansion approaches to address unmet challenges in studying and controlling biological processes with a new level of spatial, temporal, and molecular precision [1].

Our Focus Group is especially interested in combining this amber suppression approach with carefully designed *in vivo* chemistries (bioorthogonal chemistries) that allow the specific functionalization of proteins within their physiological context. To accomplish this, we have developed UAAs that can be incorporated site-specifically into proteins, and that contain functional groups which allow subsequent chemoselective and rapid labeling with biophysical probes at defined sites within the protein of interest. In the initial step, a UAA bearing a bioorthogonal group is co-translationally inserted into the protein, and in a second step, the probe is site-specifically attached to the protein (figure 2). We have developed aaRS variants for the efficient site-specific incorporation of several UAAs, bearing strained alkene or alkyne moieties into proteins expressed in *E. coli* and mammalian cells. These amino acids react chemoselectively with tetrazine conjugates via the inverse electron demand Diels Alder cycloaddition [4,5]. Such cycloadditions are exceptionally fast, highly specific and thus compatible with living cells. We have demonstrated the site-specific and selective labeling of proteins *in vitro*, and *in vivo* in *E. coli* and in live mammalian cells (both on the surface and intracellularly) with tetrazine-fluorophore conjugates. We have also used our approach for the imaging of cell-surface and intracellular proteins in living mammalian cells via super resolution techniques such as STORM, STED and SIM [2].

The invention of these techniques was awarded the Nobel Prize in Chemistry in 2014. We envision that our labeling approach will further impact the development of super-resolution techniques and address important biological questions since it allows the non-invasive, site-specific, efficient and rapid labeling of target proteins using chemical probes with tailored physical and biological properties. Additionally, we have used our bioorthogonal chemistry for selectively inhibiting a target protein (a kinase) within living cells that contain closely related protein family members. By installing photoswitchable linkers on an inhibitor, we have shown that we can selectively and reversibly control the enzymatic activity of a specific enzyme within living mammalian cells [3].

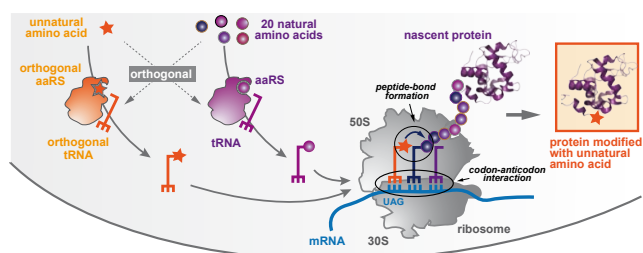

1 | Amber suppression approaches using orthogonal aaRS/tRNA systems allows the *in vivo* production of proteins bearing unnatural amino acids.

Apart from development of bioorthogonal chemistries, we are also interested in designing crosslinking chemistries – such as proximity enhanced reactions and photocrosslinking chemistries (figure 2) – to develop tools for the manipulation and study of intracellular protein activities and protein interactions. Our goal: to gain deeper insights into the organization of protein networks and signal cascades in cells. We have, for example, developed new proximity-enhanced chemistries that enable the crystallization of low-affinity protein complexes. We are also designing tools to mimic and install post-translational modifications using UAAs.

Looking ahead to the future, our aim is to focus our research on gaining insights into the mechanisms of complex biological processes through the application of synthetic molecules with tailored functions and properties. Research will focus on the targeted chemical synthesis of new artificial biomolecules (amino acids, proteins, nucleotides, oligonucleotides) that are designed to investigate and manipulate complex cellular processes in *in vitro* and *in vivo* biological systems. In particular, we plan to extend and apply approaches of site-specifically modifying and engineering proteins: The goal is to endow them with new functions through the use and development of extended, engineered orthogonal translation machineries *in vivo* through directed evolution approaches. Our group's focus on "chemical" research centers around the synthetic development of new, genetically encodable bioorthogonal reactions – including photo-inducible reactions – that enable the *in vivo* site-specific modification of target proteins with modified ligands, oligonucleotides and biophysical probes. We believe this will be interesting not only in regards to the study of important protein

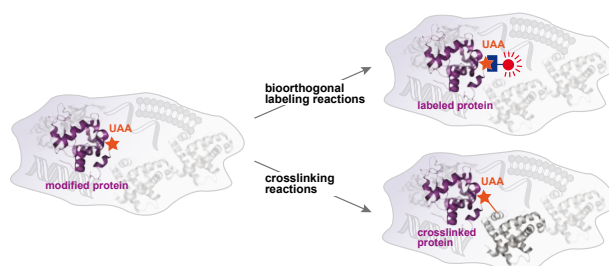

2 | Proteins bearing unnatural amino acids can be used for the site-specific functionalization of proteins with biophysical probes and for studying protein-protein interactions through crosslinking chemistries.

interactions and imaging of proteins *in vivo*, but also regarding drug design and new biomaterials. Our Focus Group will continue to approach our research from the perspective of synthetic organic chemistry: Our goal remains the pursuit of developing and extending toolkits and approaches that contribute to the exploration of questions arising at the fascinating intersection of chemistry and biology. The ability to precisely design novel protein functions with new chemistries will open up many possibilities for synthetic biology, drug design and gene therapy.

## References

- [1] K. Lang, and J. W. Chin, "Cellular incorporation of unnatural amino acids and bioorthogonal labeling of proteins," *Chem. Rev.*, vol. 114, no. 9, pp. 4764–4806, 2014.
- [2] C. Uttamapinant, J. D. Howe, K. Lang, V. Beránek, L. Davis, M. Mahesh, N. P. Barry, and J. W. Chin, "Genetic code expansion enables live-cell and super-resolution imaging of site-specifically labeled cellular proteins," *J. Am. Chem. Soc.*, vol. 137, no. 14, pp. 4602–4605, 2015.
- [3] Y.-H. Tsai, S. Essig, J. R. James, K. Lang, and J. W. Chin, "Selective, rapid and optically switchable regulation of protein function in live mammalian cells," *Nat. Chem.*, vol. 7, no. 7, pp. 554–561, 2015.

## Selected Publications

- [4] S. Mayer, and K. Lang, "Tetrazines in inverse-electron-demand Diels–Alder cycloadditions and their use in biology," *Synthesis*, vol. 49, no. 4, pp. 830–848, 2017, accepted in 2016.
- [5] S. Mayer, and K. Lang, "Chemie in lebenden Systemen," *Nachr. Chem.*, vol. 64, no. 3, pp. 301–305, 2016.

*Publications by this Focus Group can also be found in the section Publications of this report.*

# Focus Group Sterile Neutrino and Dark Matter

Dr. Thierry Lasserre (CEA, Saclay/APC, Paris) | Hans Fischer Senior Fellow  
Konrad Altenmüller, Julia Sawatzki (TUM) | Doctoral Candidates

## Scientific Reports



Thierry Lasserre

### Host

Prof. Stefan Schönert  
Experimental Physics  
and Astroparticle  
Physics, TUM

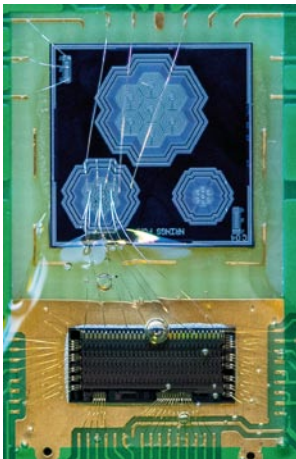

1 | A 7-pixel silicon drift detector prototype for the keV neutrino search in KATRIN. A detector with pixels of 1 mm is bonded to the IdefX-BD CEA ASIC.

## Sterile neutrinos

Neutrinos are neutral subatomic particles that rarely interact with matter. Science has identified three types of neutrinos which are associated with the electron, muon, and tau particles. As a result of decades of experimental work, scientists have found that neutrinos do have a tiny mass. Thus, due to their quantum nature, they oscillate – or change type – as they travel through space and time. Beyond the Standard Model of Physics (Standard Model upon further reference), other types of neutrinos could theoretically exist, but they would not interact with matter. This is why we usually refer to these as “sterile neutrinos.” However, sterile neutrinos might have the ability to oscillate with active neutrinos, which would make them possible to detect. Our work in the Sterile Neutrino and Dark Matter Focus Group centers on the investigation of phenomenology and experimental perspectives for detecting sterile neutrinos at different mass scales.

## keV sterile neutrinos

The nature of dark matter – what it is and how it behaves – is one of the major questions and mysteries facing the physics community. Massive relic sterile neutrinos at the keV mass scale are well-suited candidates for explaining the existence of dark matter in our universe. In 2016, our Focus Group continued with the development of methods that can be used to search for keV sterile neutrinos in an experimental laboratory setting.

The first approach we investigated is a future upgrade of the KATRIN experiment (Karlsruhe Institute of Technology, KIT), which was primarily designed to measure the known neutrino mass by studying the high-energy part of the tritium beta-decay spectrum. For our purposes, a keV sterile neutrino would specifically distort the tritium beta-decay spectrum [1]. Our group has made significant contributions to the realization and testing of new silicon drift-detector prototypes, in collaboration with the Halbleiterlabor (semiconductor laboratory) of the Max Planck Society (MPG HLL) and the Max Planck Institute for Physics (MPI for Physics). We designed and set up a new readout system and test bench, in close collaboration with the French Alternative Energies and Atomic Commission (CEA, Paris-Saclay), and provided the first characterization of these novel detectors with respect to energy resolution and noise in 2016. As a preliminary result, the 7-pixel prototypes tested (figure 1) have turned out to be suitable for the keV sterile neutrino search. A prototype detector was tested in extreme conditions during a stratospheric balloon flight, in partnership with the National Centre for Space Studies (CNES, France). The balloon flew for 12 hours up to an altitude of 29 km and, as a first application, the neutron altitude profile in the atmosphere was measured with our prototype detectors.

The second approach is an idea newly developed at the TUM-IAS. We have demonstrated that keV neutrinos trapped in our galaxy could be captured on stable dysprosium 163, thanks to their mass and energy [2]. Two experimental realizations have been studied: an integral counting of holmium 163 atoms, produced by this capture in dysprosium-rich ores; and a real-time spectroscopy of the emerging electron spectrum in a dysprosium-based detector. An experiment starting with several kilograms



2 | Stratospheric balloon used for flying our prototype detectors, during its helium filling prior to the launch at Aire-sur-Adour (France) on July 2, 2016.

of  $^{163}\text{Dy}$  and counting the number of  $^{163}\text{Ho}$  atoms induced by dark matter neutrino captures could already be competitive to search for keV sterile neutrinos. The technical feasibility of this novel concept is now being published and investigated. Since 2015, our Focus Group has led a global effort to assess the physics case for sterile neutrinos and dark matter. Together with around 150 authors from 100 institutions globally, we developed a white paper on the topic, including the observational constraints, production mechanisms in the early universe and experimental perspectives. This work, accepted for publication in the *Journal of Cosmology and Astroparticle Physics* [3], was conducted in close collaboration with the MPI for Physics and the TUM Physics department.

## eV sterile neutrinos

Sterile neutrinos in the eV mass range could also exist. This hypothesis is supported by results from several short baseline neutrino experiments reported over the last two decades. Experts in our Focus Group are participating in the CeSOX experiment. In 2018, we will deploy an intense  $^{144}\text{Ce}$ - $^{144}\text{Pr}$  antineutrino generator (3 to 5 PBq) in the vicinity of the Borexino neutrino detector, located at Italy's Laboratory Nazionali del Gran Sasso (LNGS). A positive signal would manifest as an oscillation of the neutrino interaction rate inside the liquid scintillator, as a function of their distance to the antineutrino generator. In 2016, we finalized the studies and specifications of the  $^{144}\text{Ce}$ - $^{144}\text{Pr}$  antineutrino generator, and also signed a production contract with the



3 | Test-deployment of the TUM-Genova thermal calorimeter at the Laboratory Nazionali del Gran Sasso (Italy).

Russian manufacturer of the generator. The generator's massive, 2.3-ton tungsten shield was manufactured in China. In collaboration with Stefan Schönert's chair for Experimental Physics and Astroparticle Physics and Italy's Genova University, a calorimeter was designed and built. This device was successfully tested with an electrical source, superseding the designed 1 percent accuracy. It has now been deployed at LNGS (figure 3). Measurements of the  $^{144}\text{Ce}$  and  $^{144}\text{Pr}$  beta-spectra have also been initiated to facilitate the assessment of the expected signal in Borexino. To achieve the desired sensitivity, a collaboration was initiated with the group of Bastian Märksich (TUM) to adapt the Perkeo spectrometer, and a DFG-ANR proposal will be submitted in 2017. The CeSOX experiment will start gathering data in 2018.

### Selected Publications

- [1] K. Dolde, S. Mertens, D. Radford, T. Bode, A. Huber, M. Korzeczek, T. Lasserre, and M. Slezak, "Impact of ADC non-linearities on the sensitivity to sterile keV neutrinos with a KATRIN-like experiment," *Nucl. Instrum. Methods Phys. Res. A*, vol. 848, no. 8, pp. 127–136, 2017, accepted in 2016.
- [2] T. Lasserre, K. Altenmueller, M. Cribier, A. Merle, S. Mertens, and M. Vivier, "Direct search for keV sterile neutrino dark matter with a stable dysprosium target," online ahead of publication, 2017, accepted in 2016.
- [3] R. Adhikari, M. Drewes, T. Lasserre, S. Mertens, A. Merle, et al., "A white paper on keV sterile neutrino dark matter," *JCAP*, vol. 2017, no. 1, p. 025, 2017, accepted in 2016.

*Publications by this Focus Group can also be found in the section Publications of this report.*

# Focus Group **Chemical Catalysis, Photo-catalysis and Electro-catalysis**

Prof. Suljo Linic (University of Michigan) | Hans Fischer Fellow  
Simon P. Rittmeyer (TUM) | Doctoral Candidate

Scientific Reports



Suljo Linic

© Hosts

[Prof. Ulrich Heiz](#)

Physical Chemistry, TUM

[Prof. Karsten Reuter](#)

Theoretical Chemistry,

TUM

## Energy exchange at metal surfaces:

### Where does the energy come from? Where does it go?

Energy dissipation during surface dynamical processes on solid surfaces has been extensively studied, both due to its outstanding technological importance in heterogeneous catalysis as well as its intriguing fundamental richness of applications. Adsorption of molecules, diffusion on the substrate and – not least – surface chemical reactions are all known to be intricately governed by the detailed ways in which chemical and kinetic energy is transferred into and out of substrate degrees of freedom.

On insulating or semiconducting surfaces, the dynamical coupling to the surface can clearly be attributed to the excitation of and interaction with lattice vibrations – so-called phonons. On metal surfaces, however, the availability of gapless electron-hole pair excitations in the substrate offers a competing energy dissipation channel. The actual role of these electronically non-adiabatic effects is an ever-continuing topic of debate. In fact, there is growing experimental evidence that can only be rationalized by breaking with the prevalent Born-Oppenheimer view of nuclear dynamics evolving only on the ground state potential energy surface [1].

Our research is therefore aimed at gaining a deeper understanding of these different energy transfer processes and their relative importance for surface dynamical phenomena. With high-level non-adiabatic simulations still intractable for extended metal surfaces, we rely on the approximative – but numerically highly efficient – concept of electronic friction within the local density friction approximation (LDFA). The numerical efficiency of this approach stems from an implicit consideration of the electron-hole (*eh*)-pair excitations that allow us to effectively replace the coupled electron-nuclear dynamics with a simple Langevin-equation of motion for the nuclei. All non-adiabatic effects are then condensed into and described by the so-called electronic friction coefficient.

This inherent simplicity has, however, raised conceptual concerns about the accuracy of this model. Aiming to clarify this picture, we first assessed vibrational lifetimes of high-frequency adsorbate modes as a sensitive measure to gauge the predicted non-adiabatic energy losses against experimental benchmark values [2]. Though general trends were adequately captured, our analysis revealed certain deficiencies of the prevalent LDFA for most relevant molecular adsorbates. We responded by introducing a simple and computationally highly efficient strategy to extend the LDFA beyond the available inherent independent-atom approximation, which compares quantitatively with experimental and theoretical reference data.

With this having increased our confidence in the model, we further applied the LDFA-based electronic friction formalism to thermal surface diffusion, where electronically non-adiabatic energy losses are expected to clearly compete with energy losses due to phononic coupling [3].

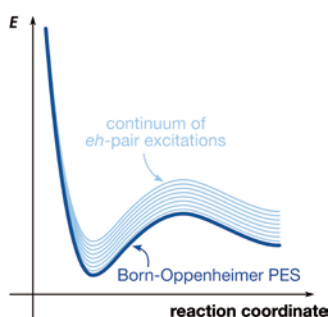

1 | Dynamics on a metal surface do not necessarily evolve on the ground state Born-Oppenheimer potential energy surface (PES). Instead, non-adiabatic coupling to the continuum of electron-hole pair excitations has to be taken into account.

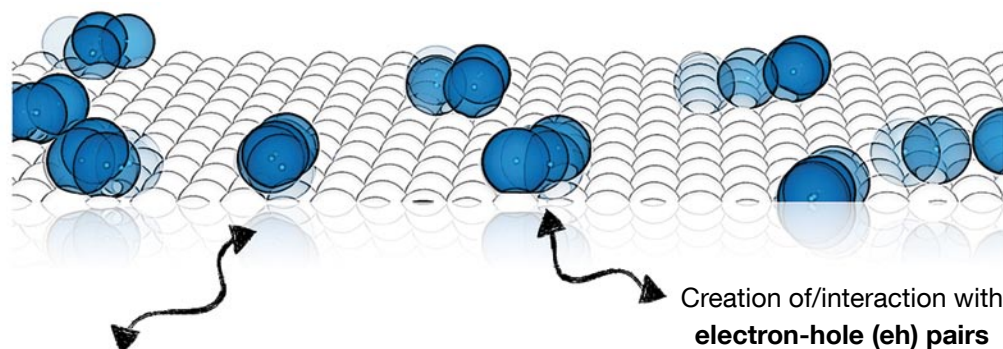

Creation of/interaction with substrate **phonons**

2 | Overview of the most important energy exchange mechanisms between diffusing adsorbates and a metallic substrate.

In order to quantitatively disentangle these dissipation channels, we first compared *ab initio*-based Langevin molecular dynamics (MD) simulations for Na on Cu(111) to experimental signatures obtained from state-of-the-art  $^3\text{He}$  spin echo measurements. The resulting friction coefficient contains contributions from both phononic and electronically non-adiabatic coupling. A subsequent analysis of the underlying trajectories involving an explicit evaluation of the electronic friction coefficient in the LDFA model then allowed for a quantitative estimate of the relative importance of non-adiabatic and phononic surface coupling, respectively. Despite the minimal electronic friction coefficient of Na and the relatively small mass mismatch to Cu promoting efficient phononic dissipation, we found that a surprisingly high amount of about 20 percent of the total energy loss is attributable to electronic friction.

All in all, the picture that emerges is of surface diffusion in which electronic non-adiabaticity plays a much more prominent role than previously anticipated. Indeed, one could speculate that it is in fact electronic non-adiabaticity that ensures rapid thermalization in adsorbate systems with a large frequency mismatch, and that also explains the long-term success of adiabatic theories to determine diffusion constants and other kinetic parameters for growth and catalysis applications.

## References

- [1] A. M. Wodtke, "Electronically non-adiabatic influences in surface chemistry and dynamics," *Chem. Soc. Rev.*, vol. 45, no. 13, pp. 3641–3657, 2016.
- [2] S. P. Rittmeyer, J. Meyer, J. I. Juaristi, and K. Reuter, "Electronic friction-based vibrational lifetimes of molecular adsorbates: beyond the independent-atom approximation," *Phys. Rev. Lett.*, vol. 115, no. 4, pp. 046102-1–04102-5, 2015.

## Selected Publication

- [3] S. P. Rittmeyer, D. J. Ward, P. Gütlein, J. Ellis, W. Allison, and K. Reuter, "Energy dissipation during diffusion at metal surfaces: disentangling the role of phonons versus electron-hole pairs," *Phys. Rev. Lett.*, vol. 117, no. 19, pp. 196001-1–196001-5, 2016.

*Publications by this Focus Group can also be found in the section Publications of this report.*

# Focus Group Protein Misfolding and Amyloid Diseases

Prof. Ayyalusamy Ramamoorthy (University of Michigan) | Hans Fischer Senior Fellow  
Dr. Diana Rodriguez Camargo (TUM) | Postdoctoral Researcher

## Scientific Reports



Ayyalusamy Ramamoorthy

## © Host

Prof. Bernd Reif

Solid-State NMR, TUM

The topic of our Focus Group is the investigation of the structure, dynamics and aggregation of the hormone, human islet amyloid polypeptide (hIAPP), in the presence of lipid membranes using magic-angle spinning (MAS), and solid-state nuclear magnetic resonance (NMR) experiments. Our research work in two different sub-projects is summarized below.

## High-resolution structural differences between oxidized and reduced hIAPP

Type 2 diabetes (T2D) is characterized by diminished insulin production and cell resistance to insulin, which in turn triggers the overproduction of regulatory hormones such as insulin and hIAPP. Among others, endoplasmic reticulum (ER) stress is a principal factor contributing to T2D, and induces a shift towards a more reducing cellular environment. We could show that the differential aggregation of reduced and oxidized hIAPP assists to maintain the redox equilibrium in the cell by restoring redox equivalents. Aggregation therefore induces redox balancing, which can assist initially in counteracting ER stress. Failure of the protein degradation machinery might finally result in beta cell ( $\beta$ -cell) disruption and cell death. We further characterized the structure of hIAPP in solution, and demonstrated that the N-terminus of the oxidized peptide has a high propensity to form an alpha-helical ( $\alpha$ -helical) structure, which is absent in the reduced state of hIAPP. In healthy cells, this residual structure prevents the conversion into amyloidogenic aggregates.

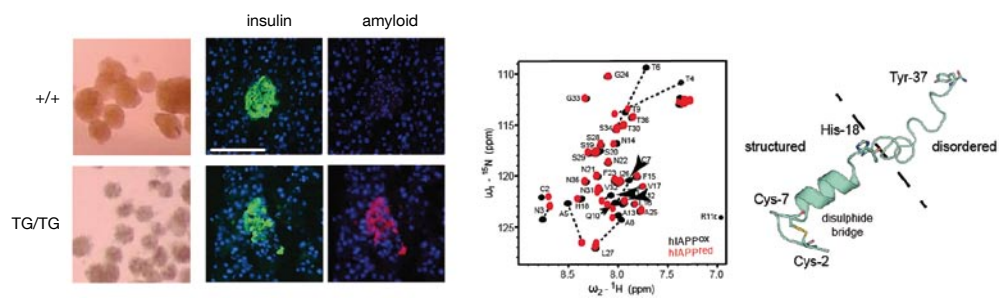

1 | In Type 2 diabetes, overexpression of the hormone hIAPP results in the loss of beta cells in the pancreas. Left: Light microscopy and histological immunofluorescence images of islets from +/+ control mice and TG/TG mice. Insulin is indicated in green, amyloid fibrils in red, nuclei in blue. +/+ control mice do not display any morphological changes. Amyloid aggregates are observed using an antibody against amyloid fibrils in islets of TG/TG mice. Center: Solution-state NMR  $^1\text{H}$ ,  $^{15}\text{N}$  HSQC spectra of reduced and oxidized hIAPP. Right: Structural model of a conformer of the hIAPP ensemble. hIAPP<sup>ox</sup> has a high  $\alpha$ -helical propensity involving residues 8-17, and is disordered in its C-terminal part.



## Structural characterization of membrane-bound hIAPP intermediates

We further investigated the membrane interaction and aggregation of hIAPP to better understand its toxicity to islet cells in Type 2 diabetes. Since the interaction of hIAPP with the lipid membrane dramatically speeds up the aggregation of hIAPP to form amyloid fibrils, it has been a major challenge to obtain structural insights into the formation of toxic hIAPP intermediates. To overcome this challenge, we have successfully optimized the lipid composition encapsulated in nanodiscs to trap an intermediate of hIAPP by using a variety of biophysical experiments including fluorescence, dynamic light scattering and NMR spectroscopy. Nanodisc preparations are done in collaboration with Franz Hagn (TUM-IAS Rudolf Mößbauer Tenure Track Assistant Professor). High-resolution NMR spectra obtained from hIAPP reconstituted in lipid nanodiscs demonstrate the feasibility of solving the three-dimensional structure of the membrane-bound hIAPP non-fibril intermediate.

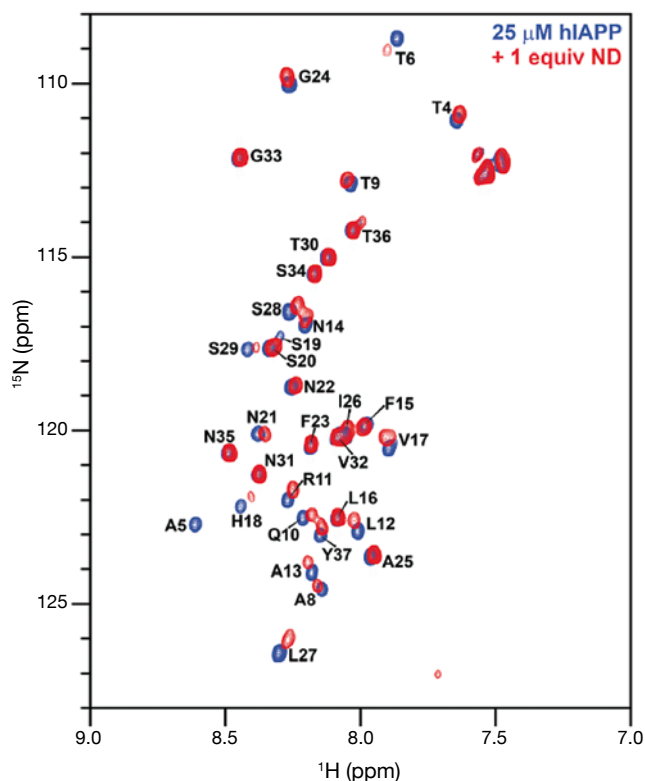

2 | 2-D  $^1\text{H}$ ,  $^{15}\text{N}$  HSQC spectra of hIAPP in solution (blue) and reconstituted in nanodiscs (red).

### Selected Publication

- [1] D. C. Rodriguez Camargo, K. Tripsianes, K. Buday, A. Franko, C. Göbl, C. Hartlmüller, R. Sarkar, M. Aichler, G. Mettenleiter, M. Schulz, A. Böddrich, C. Erck, H. Martens, A. K. Walch, T. Madl, E. E. Wanker, M. Conrad, M. Hrabě de Angelis, and B. Reif, "The redox environment triggers conformational changes and aggregation of hIAPP in Type II Diabetes," *Nature Sci. Rep.*, 2017, accepted in 2016.

## Focus Group **Biomedical Humanities**

Prof. Giovanni Boniolo (Università di Ferrara) | Anna Boyksen Fellow  
Maria Marloth (TUM) | Doctoral Candidate

### Scientific Reports



Giovanni Boniolo

### © Host

Prof. Mariacarla  
Gadebusch Bondio  
Institute for History  
and Ethics of Medicine,  
TUM

Recent advances in the understanding of the molecular basis of disease – at the level of genetic predisposition as well as of the interaction with individual diversities, lifestyles and environments – are drastically modifying the diagnosis, therapy and prevention of disease. Furthermore, these new revelations are also changing our perceptions of what constitutes illness and health.

Against this backdrop, there is a clear need for innovative foundational and ethical analyses: these could be provided under the auspices of a Biomedical Humanities framework. A biomedical humanities perspective is a humanistic approach that ethically and philosophically addresses that chain which commences with basic and translational research into the molecular roots of diseases. It also addresses issues of disease detection, and how to cope with the cause of disease (and disease itself) by taking into account an individual patient's genetic makeup, diversity (e.g., dealing with gender, sexuality, aging, culture, socio-economical status, religious beliefs, etc.), lifestyle and aspirations. It finishes with the care of patients in clinical practice.

In particular, the Focus Group Biomedical Humanities at the TUM-IAS is working to explore how well-designed ethical counselling services could improve the decision-making process for both patients and medical practitioners whenever diversity issues arise.

With “ethical counselling,” we are referring to a dialog that could be implemented in the cases in which clinical decisions involve existential issues and moral questions. Such a dialog serves two different purposes: On the one hand, by investigating and clarifying a patient's values and beliefs, an ethical counselling process would assist a patient with overcoming any ethical decisional paralysis in clinical settings – and allow them to choose the option most aligned with their moral sensitivity. On the other hand, this tool would train clinicians to properly examine the ethical and existential aspects of problematic healthcare situations and decisions being faced by patients and their families and friends. One central point of ethical counselling is to go beyond common sense and intuitive moral understanding in order to weigh all options before making a given choice. The kind of critical reflection which takes place during the dialog promotes a non-directive, non-paternalistic and highly individualized decision-making process. The process should also serve the purpose of debunking the fallacious conviction that a physician's moral way of thinking is somehow superior to that of the patient.

The Focus Group promotes a humanistic approach to medicine by putting the patient at the center. Indeed, one of its central aims is to improve more awareness – particularly among biomedical researchers and clinicians – of the relevance of personalized medicine and healthcare that derives from an ethical base. Moreover, the group is working to encourage the development of an appropriate sensibility towards diversity issues. In order to achieve these aims, beyond the papers listed below, we have realized three international meetings:

- Workshop “[Ethical Counselling in the Age of Personalized Medicine and Multicultural Diversity](#),” held on May 19, 2016,
- ESO/TUM-IAS Masterclass “[Ethical Counselling in Oncology and Gender Issues](#),” held on November 23–24, 2016,
- Liesel Beckmann Symposium “[Ethical Counselling in the Age of Personalized Medicine and Diversity Issues](#),” held on November 25, 2016.

Furthermore, with the contribution of a renowned neuropsychologist, we are finalizing a paper on the modulation in function of diversity of the empathic relationship which could grow between a patient and healthcare practitioner (e.g., doctors, clinicians, nurses, etc.). In addition, we are thinking of publishing the contributions presented at the Liesel Beckmann Symposium in the form of a special issue of a journal.

### References

- [1] G. Boniolo, “Molecular medicine: the clinical method enters the lab. What tumor heterogeneity and primary tumor culture teach us.” In G. Boniolo, M. Nathan (eds.), *Philosophy of Molecular Medicine: Foundational Issues in Research and Practice*, Routledge, New York 2017, Chapt. 1.
- [2] M. Gadebusch Bondio and F. Spöring, “Personalized Medicine: Historical Roots of a Medical Model.” In G. Boniolo, M. Nathan (eds.), *Philosophy of Molecular Medicine: Foundational Issues in Research and Practice*, Routledge, New York 2017, Chap. 2.

### Selected Publications

- [3] F. Boem, E. Ratti, M. Andreoletti, and G. Boniolo, “Why genes are like lemons,” *Stud. Hist. Philos. Biol. Biomed. Sci.*, vol. 57, pp. 88–95, 2016.
- [4] G. Boniolo, “Public obligation and individual freedom: how to fill the gap? The case of vaccinations,” *J. Public Health Res.*, vol. 5, pp. 58–59, 2016.
- [5] G. Boniolo and V. Sanchini, Eds., “Ethical counselling and medical decision-making in the era of personalized medicine,” 1st ed., Heidelberg: Springer, 2016.
- [6] O. Golubnitschaja, B. Baban, G. Boniolo, W. Wang, R. Bubnov, M. Kapalla, K. Krapfenbauer, M. S. Mozaffari, and V. Costigliola, “Medicine in the early twenty-first century: paradigm and anticipation - EPMA position paper 2016,” *EPMA J.*, vol. 7, no. 23, 2016.

*Publications by this Focus Group can also be found in the section Publications of this report.*

# Focus Group Gender and Diversity in Science and Engineering

Prof. Sarah De Rijcke (Leiden University) | Anna Boyksen Fellow  
Isabel Burner-Fritsch (TUM) | Research Assistant

Scientific Reports

## Evaluation practices & diversity: The case of engineering



Sarah De Rijcke

© Host

Prof. Ruth Müller

Munich Center for  
Technology in Society,  
TUM

The Focus Group Gender and Diversity in Science and Engineering analyzes the inclusion and exclusion mechanisms of evaluation procedures and indicators in the engineering sciences. Thus far, the engineering sciences are an underexplored area when it comes to analyzing the effects of research assessment on the organization and production of knowledge.

Researchers are pulled in various, sometimes contradictory directions by the multiplication of performance metrics and new incentives to align with societal needs. Management structures, funding systems and publication practices are increasingly influenced by pressures to promote only the highest quality science – as well as by models and incentives for academic advancement that would produce this highest quality. While some analysts welcome the possibility of increasing transparency through performance data, recent years have seen high-profile initiatives to improve current criteria for assessing academic achievements (e.g., the Leiden Manifesto, the Metric Tide, Science in Transition, DORA, METRICS, Reward Alliance). Concerns include both an erosion of the social in science – e.g., increasing competitive struggles, blistering “benchmark masculinity” (Thornton 2013), waning collegiality, decreasing community service - and an erosion of epistemic diversity - e.g. cropping and tweaking the aims and contents of scientific inquiry to fit into the narrow confines of metric-based evaluation systems.

The collaboration in the Focus Group is embedded in an emerging research agenda on the epistemic effects of indicators in academic settings (cf. Derrick & Gillespie, 2013; Gläser, 2013; Müller, 2014; Hammarfelt & De Rijcke, 2015; Rushforth & De Rijcke, 2015; De Rijcke et al. 2016). From our previous projects in the life sciences, the social sciences and law in the Netherlands, Austria, and Sweden, we can extrapolate, first of all, that quantitative indicators feed into quite routine knowledge-producing activities (e.g. discussions over whom to collaborate with and when, how much time to spend in the laboratory producing data) (Rushforth & De Rijcke, 2015). Researchers are increasingly “thinking with indicators” at various stages throughout their research processes [1].

The Anna Boyksen Fellowship enables the Focus Group to further chart these reification dynamics, and in- and exclusion mechanisms in evaluation systems. This is needed in order to develop more sophisticated policies and refined ways for the conscientious application of evaluative metrics in different fields. Some of these ways in which metric indicators become pivotal to academic work seem to be in strong tension with central ideals and goals of European, national and institutional research policies: to foster diversity-relevant, innovative, collaborative and socially responsible science.

Thus far, the engineering sciences are an under-explored area when it comes to analyzing the inclusion and exclusion mechanisms of evaluation procedures and indicators. Methodologically, research evaluation is modeled on the natural sciences (Nature, 2010), but the same methods are increasingly applied to technical sciences at large (De Jong et al., 2011; Donovan, 2007; Martin et al., 2010).



1 | Gender bias in academic advancement systems.

However, technical sciences are characteristically much more applied, and generally speaking, more oriented towards a broader impact than most natural sciences. This means, for instance, that the usefulness of citation-based indicators is debatable: authoritative research output consists of more than scientific journal articles only, and can also include proceedings, designs, computer programs, prototypes, etc. (Butler, 2007; Franceschet, 2010; KNAW, 2010; TU Delft, 2007). In the Focus Group, we ask: What are the consequences of this shift toward the prevailing metric-based orders of worth in research assessment for the epistemic culture and authorship practices of the engineering sciences? How does such a shift relate to other practices of valuation in the engineering sciences? How do they affect possible career paths as well as patterns of inclusion and exclusion in these fields of research and development?

### Objectives for the Focus Group

- [Provide an overview of existing evaluation procedures](#) and policy initiatives for the engineering sciences in the Netherlands and Germany.
- [Identify best practices](#) on the basis of secondary document analysis.
- [Develop a suitable empirical approach](#) to analyze the particular values enacted in evaluation systems in the engineering sciences, and the effects of performance indicators on knowledge production in engineering. Based on our earlier work we expect to draw on semi-structured interviews, document analysis, and observations of day-to-day decision-making processes of research groups.
- [Carry out an in-depth qualitative project](#) in the engineering sciences on the basis of this empirical approach. The study will most likely be comparative and will consist of at least two case studies in our respective national contexts.
- [Draw out differences between the new findings and results](#) from our own previous research in the life sciences, social sciences and law.
- [Integrate these analyses into more refined ways](#) for responsible application of evaluative metrics in engineering fields.

The first three objectives were met in 2016. The Focus Group recently organized two workshops with leading figures in research policy and science and technology studies (September and December 2016). The aim of the workshops was to lay the groundwork for a joint funding application for the Open Research Area (ORA) program, which funds joint research projects in the social sciences. This program is a collaboration between the UK, the Netherlands, France and Germany. The funding application will build on the work currently developed in the Focus Group led by Sarah de Rijcke and Ruth Müller.

### References

- [1] R. Müller and S. de Rijcke, "Thinking with Indicators. Exploring the Epistemic Impacts of Academic Performance Indicators in the Life Sciences," *Res. Eval.*, forthcoming.
- [2] S. de Rijcke and T. Stockelova, "Feeding off and feeding up the dominant: Predatory publishing and the imperative of international productivity," in *Gaming Metrics*, M. Biagioli and A. Lippmann, Eds. Cambridge: MIT Press Infrastructures series, forthcoming.

*Publications by this Focus Group can also be found in the section Publications of this report.*

## Focus Group Preventive Pediatrics

Prof. Regina Ensenaer (Heinrich Heine University Düsseldorf) | Anna Boyksen Fellow  
Dr. Annette Wacker-Gußmann, Dr. Silvia Lobmaier | Research Associates

### Scientific Reports



Regina Ensenaer

### © Host

Prof. Renate Oberhoffer  
Preventive Pediatrics,  
TUM

### Gestational diabetes – impact of metabolic dysregulation on the perinatal vascular health of mother and child

There is increasing evidence, from both human epidemiological and animal studies, that the maternal metabolic milieu during critical time windows of development permanently influences metabolic regulation and function in the offspring later in life. Relevant prenatal risk factors for childhood overweight and metabolic disease include maternal overnutrition, excessive gestational weight gain, and gestational diabetes [1]–[2]. The prevalence of gestational diabetes has dramatically increased worldwide; according to current estimates, more than 10 percent of pregnancies are affected [3]. This makes it the most frequent metabolic disease in pregnancy with negative effects on the vascular system [4]. Adverse pregnancy outcomes are offspring cardiac malformations [5], large-for-gestational-age birth weight, neonatal hypoglycemia and long-term health risks for both mother and child. While the phenotypic consequences on offspring organs such as the cardiovascular system are not entirely understood, studies suggest an increased risk for obesity and diabetes in children who were exposed to a diabetic milieu in pregnancy [6]. However, the specific mechanisms and metabolic pathways underlying the relationship between maternal hyperglycemia, potentially early vascular alterations in pregnancy and adverse offspring outcomes are largely unknown.

Our goal has been to investigate both the development of functional und structural vascular changes in pregnant women with gestational diabetes and their fetuses, as well as to identify associated metabolic dysregulations in their offspring at birth. To facilitate this, we designed the gestational diabetes and vascular disease (GEDIVA) study as a prospective cohort study of mothers with gestational diabetes versus healthy, nondiabetic mothers (controls) and their children. In cooperation with the TUM Department of Obstetrics and Gynecology, Klinikum rechts der Isar, we are currently recruiting pregnant women who qualify for inclusion in the study if they are  $\geq 18$  years of age and have given written informed consent. The study's exclusion criteria: pregnant women with a preexisting diagnosis of either type 1 or 2 diabetes.

Our Focus Group performs quantitative determination of functional versus structural vascular impairment in women and their fetuses – both during pregnancy and at a follow-up examination 12 months *post partum*. Additional clinical outcome parameters include child anthropometry. We have also gathered detailed information on other prenatal factors for childhood health risks including maternal preconception body mass index (BMI) data.



1 | Preparation of umbilical cord blood from newborns of mothers with gestational diabetes.

For the investigation of global metabolic imbalances in cord blood of the exposed offspring, MS/MS-based technology is applied (targeted metabolite profiling). A protocol for the standardized and optimized collection and handling of cord blood prior to analysis has been developed, and is currently being applied at the time of delivery for every woman participating in the study.

Results are expected to: 1) identify early vascular dysfunctions in the pregnancies of women with gestational diabetes and their offspring; and 2) derive a specific metabolite pattern in umbilical cord blood of pregnancies complicated by gestational diabetes and potential vascular dysfunctions – patterns that may serve as a risk indicator of impaired maternal and/or offspring health in longitudinal investigations.

*This work was conducted in cooperation with doctoral candidates Jule V  th and Maike Wagner.*

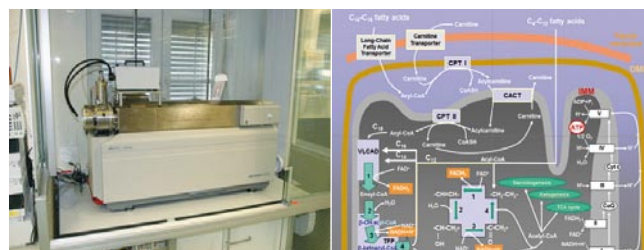

2 | Targeted metabolite profiling by liquid chromatography-tandem mass spectrometry: quantification and interpretation of metabolite patterns from umbilical cord blood.

## References

- [1] R. Ensenauer, L. Brandlhuber, M. Burgmann, C. Sobotzki, C. Zwafink, S. Anzill, L. Holdt, D. Teupser, U. Hasbargen, H. Netz, A. A. Roscher, and R. von Kries, "Obese nondiabetic pregnancies and high maternal glycosylated hemoglobin at delivery as an indicator of offspring and maternal postpartum risks: the prospective PEACHES mother-child cohort," *Clin. Chem.*, vol. 61, no. 11, pp. 1381–1390, 2015.
- [2] I. Nehring, A. Chmitorz, H. Reulen, R. von Kries, and R. Ensenauer, "Gestational diabetes predicts the risk of childhood overweight and abdominal circumference independent of maternal obesity," *Diabet. Med.*, vol. 30, no. 12, pp. 1449–1456, 2013.
- [3] E. A. Huhn, N. Massaro, S. Streckeisen, G. Manegold-Brauer, A. Schoetzau, S. M. Schulzke, B. Winzeler, I. Hoesli, O. Lapaire, "Fourfold increase in prevalence of gestational diabetes mellitus after adoption of the new International Association of Diabetes and Pregnancy Study Groups (IADPSG) criteria," *J. Perinat. Med.*, vol. 44, no. 6, 2016.
- [4] G. Yousefzadeh, H. Hojat, A. Enhesari, M. Shokoohi, N. Eftekhari, M. Sheikhhvatan, "Increased carotid artery intima-media thickness in pregnant women with gestational diabetes mellitus," *J. Tehran Heart Center*, vol. 7, no. 4, pp. 156–159, 2012.
- [5] R. Oberhoffer, J. Hogel, F. Stoz, E. Kohne, D. Lang, "Cardiac and extracardiac complications in infants of diabetic mothers and their relation to parameters of carbohydrate metabolism," *Eur J pediatrics*, vol. 156, no. 4, pp. 262–265, 1997.
- [6] P. Damm, A. Houshmand-Oeregaard, L. Kelstrup, J. Lauenborg, E. R. Mathiesen, and T. D. Clausen, "Gestational diabetes mellitus and long-term consequences for mother and offspring: a view from Denmark," *Diabetologia*, vol. 59, no. 7, pp. 1396–1399, 2016.

*Publications by this Focus Group can also be found in the section Publications of this report.*

# Focus Group Gender Stereotypes in Organizations

Prof. Madeline E. Heilman (New York University) | Anna Boyksen Fellow

## Scientific Reports



Madeline E. Heilman

### © Host

Prof. Isabell M. Welpe  
Strategy and  
Organization, TUM

The Focus Group Gender Stereotypes in Organizations aims to understand how gender stereotypes and the expression of emotions jointly influence how people form impressions about men and women, particularly focusing on the context of leadership in organizations.

Research shows that men and women face stereotype-based biases within organizations. They are seen differently, with men being perceived as more agentic and work-oriented than women, and with women being seen as more communal and focused on relationships than men. In addition to being perceived differently, men and women are also expected to comply with these stereotypic views. Failure to do so results in social penalties: for example, women who violate stereotypic expectations tend to be disliked and seen as interpersonally hostile.

As the expression of emotions similarly communicates social information about the emotion expresser, our work examines how gender stereotypes and emotion expressions jointly influence how people form impressions about the emotion-expressing individuals. Using experimental research designs, we show study participants pictures of men and women expressing either pride or happiness, and ask them what they think the person is like.

Figure 1 shows the pattern of our main findings exemplarily for agency. In line with gender stereotypes, study participants perceived the women in the pictures as less agentic than the men when they expressed happiness. This gender effect diminished when the women and men expressed pride in the pictures. Furthermore, the effect of expressing pride as compared to expressing happiness was more pronounced for women than for men in the perception of study participants. We have shown these described effects apply not only to attributes such as agency, but also for related inferences about competence in task-oriented leadership behaviors and an individual's perceived willingness to lead.

Additionally, pride expressions not only diminished differential ascriptions of agency, but also diminished differential ascriptions of stereotype-based communality. Thus, whereas women were seen as more communal than men when expressing happiness, this difference disappeared when pride was expressed. Again, the effect of pride expressions on ascriptions of communality was more pronounced for women than for men.

Notably, when expressing pride, women were not seen as more interpersonally hostile than men. This finding is contrary to previous research showing that women are penalized for other stereotype-violating agentic behaviors, such as self-promotion or being perceived as power seeking. Thus, in sum, the results suggest that the expression of pride in one's achievements can ameliorate the negative effects of gender-based non-agentic stereotypes on women's career prospects. However, women need to be aware that with the expression of pride they may also lose the advantage of being seen as more communal than men.



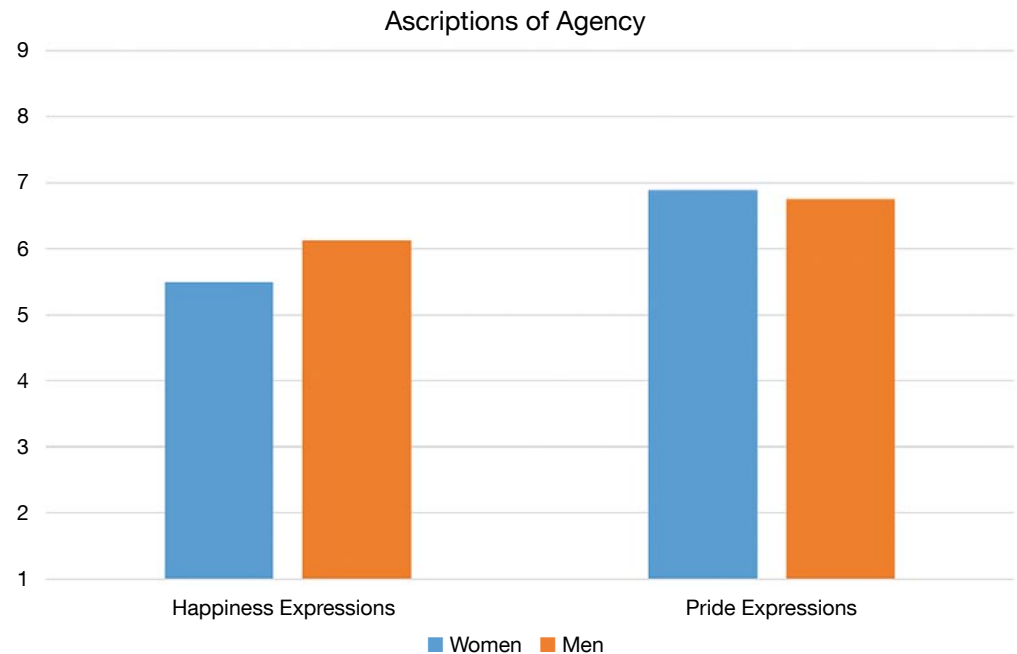

In 2016, the first paper reporting these results was accepted for publication in the *Journal of Applied Psychology* [1]. Following the successful submission of a second paper to the Academy of Management conference, it was selected for publication in the Best Paper Proceedings of the Academy of Management [2].

Having shown the effects of pride expressions for women and men, the Focus Group on Gender Stereotypes in Organizations is currently examining the boundary conditions of these effects. This includes, for example, examining pride expressions in competitive situations to determine if the beneficial effects of pride expression for women in the workplace can also be extrapolated to a situation in which a woman expresses pride in a competitive situation in which she has beaten the competition.

*This work was conducted in close cooperation with postdoctoral researcher Prisca Brosi (Strategy and Organization, TUM).*

#### Selected Publications

- [1] P. Brosi, M. Spörrle, I. M. Welpe, and M. E. Heilman, "Expressing pride: effects on perceived agency, communality, and stereotype-based gender disparities," *J. Appl. Psychol.*, vol. 101, no. 9, pp. 1319–1328, 2016.
- [2] P. Brosi, M. Spörrle, I. M. Welpe, and M. E. Heilman, "Willing to lead, not willing to follow: gender-specific inferences from pride expressions," *Acad. Manag. Proc.*, vol. 1, no. 11982, 2016.

*Publications by this Focus Group can also be found in the section Publications of this report.*

# Focus Group Proteases in the Brain

Prof. Carl P. Blobel (Hospital of Special Surgery, Weill Cornell Medicine)

Hans Fischer Senior Fellow

Johanna Tüshaus (TUM) | Doctoral Candidate

## Scientific Reports



Carl P. Blobel

### © Host

Prof. Stefan Lichtenthaler  
Neuroproteomics, TUM

1 | Diagrammatic representation of different cell types in the brain (left), and of the main focus of our group (right), the release of the pro-inflammatory cytokine  $TNF\alpha$  by the signaling scissors ADAM17, which in turn are controlled by the 7-membrane spanning molecule inactive Rhomboid 2 (iRhom2) [1].

Our Focus Group is dedicated to improving the understanding of how inflammation causes diseases of the brain. We hope that our efforts will ultimately allow us to contribute to the development of better treatments for devastating human diseases such as Alzheimer's dementia and traumatic brain injury. Towards this end, we are studying molecular scissors in immune cells in the brain that most likely are important for generating an inflammatory milieu: we hypothesize that this contributes to the development of neurodegenerative diseases.

Over the last year, our group has focused on two major categories: neuroinflammation and studies of molecular scissors. Stefan Lichtenthaler and Carl Blobel recently outlined the scientific background and rationale for ongoing studies in their Focus Group in an editorial entitled "iRhoms in the brain – a new frontier?" [1]. Briefly, a PNAS paper published by Carl Blobel's lab in 2015 demonstrated that iRhoms (inactive Rhomboid-like proteins) differentially regulate a pair of molecular scissors, termed ADAM17 (a disintegrin and metalloprotease) in different cell types in the brain. iRhom2 appears to regulate pro-inflammatory functions of ADAM17 in microglia (immune cells of the brain, figure 1), whereas iRhom1 controls the function of ADAM17 in other cell types in the brain, but not in microglia.

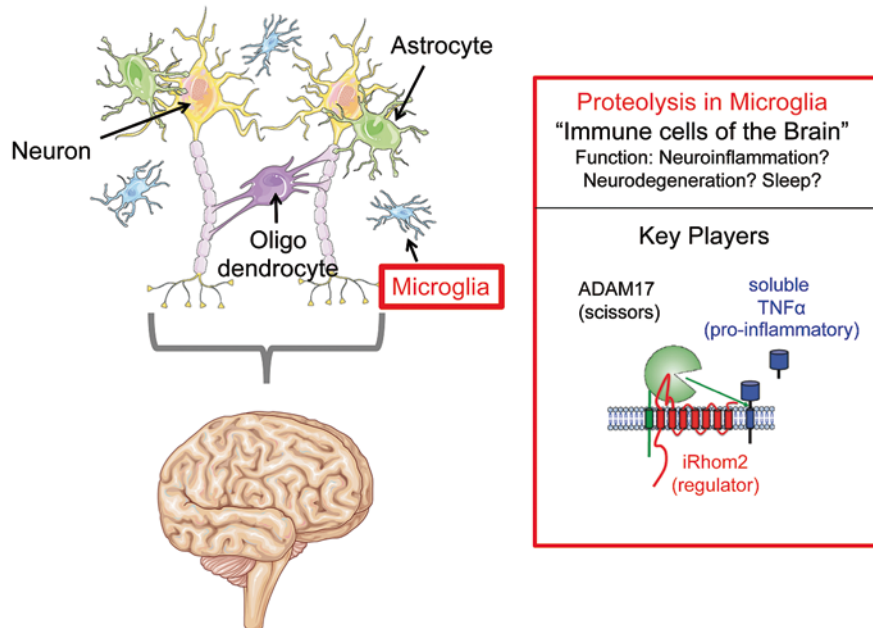

Throughout the last year, Simone Scilabra, a member of Stefan Lichtenthaler's lab, has crossed mice that are prone to developing Alzheimer's disease with mice that lack iRhom2 in order to determine how the absence of iRhom2 affects the development of Alzheimer's disease in mice. Preliminary studies are promising, in that Alzheimer's-model mice lacking iRhom2 show reduced amyloid burden and a decrease in the number of microglia associated with amyloid plaques. The Focus Group is currently working on a manuscript to disseminate these findings. Additionally, Simone Scilabra has identified several novel substrates for iRhom2/ADAM17 in immune cells using an innovative and powerful mass spectrometric technique developed in the Lichtenthaler lab. This technique also allowed the Lichtenthaler

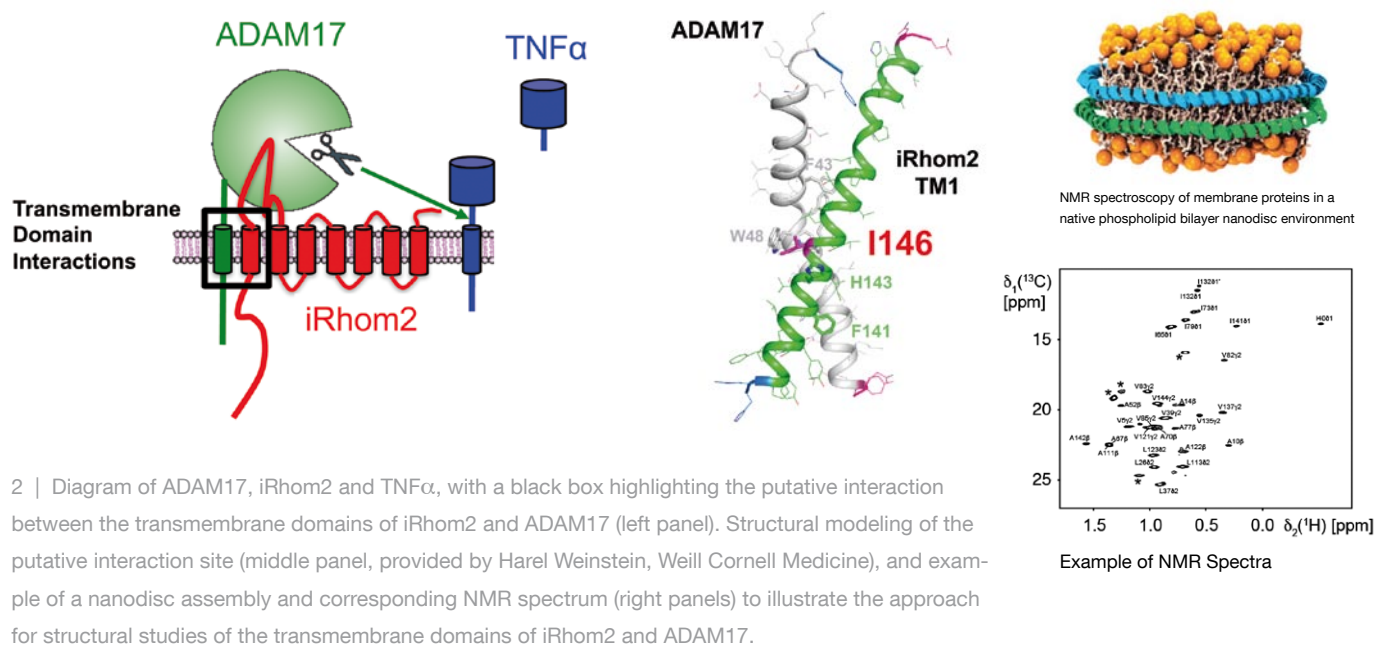

group to identify the most important substrates for the related metalloprotease ADAM10 in the brain, thus uncovering several unexpected and novel functions for this enzyme [2]. Doctoral candidate Johanna Tüshaus, a recent recipient of a Böhlinger Ingelheim PhD fellowship, is expanding the boundaries of this approach by using it to search for differences in minute droplets of cerebrospinal fluid from iRhom-deficient mice compared to normal controls, an exciting and promising new direction for our Focus Group.

Our second major interest is to determine how exactly the scissors ADAM17 interact with their regulators, the iRhoms, in molecular detail. The Blobel lab has collaborated with computational and structural biologists at his home institution, Weill Cornell Medicine in New York (Jose Manuel Perez Aguilar and Harel Weinstein) to uncover compelling evidence for an interaction between the transmembrane domains of ADAM17 and the iRhoms. These studies set the stage for an exciting collaboration with Franz Hagn at TUM-IAS, who is attempting to examine the interaction of iRhoms and ADAM17 at the level of individual atoms using NMR spectroscopy. Specifically, he plans to visualize the structure of these transmembrane domains after inserting them into lipid microdomains termed “nanodiscs”. The results of structural modeling of the interaction between iRhoms and ADAM17 and the crucial experimental validation of these models by

nanodisc NMR is guiding complementary functional studies to corroborate the physiological relevance of these interactions in intact cells in the Blobel and Lichtenthaler labs. The ultimate goal is to use this information to uncover new targets for treatment of neuroinflammation in Alzheimer’s disease and traumatic brain injury. We look forward to continuing our highly collaborative and interdisciplinary studies in Munich.

*In cooperation with Dr. Simone Scilabra (DZNE, TUM) and TUM-IAS Rudolf Mößbauer Tenure Track Professor Franz Hagn (Structural Membrane Biochemistry).*

#### Reference

- [1] S. F. Lichtenthaler, B. F. O’Hara, and C. P. Blobel, “iRhoms in the brain - a new frontier?” *Cell Cycle*, vol. 14, no. 19, pp. 3003–3004, 2015.

#### Selected Publication

- [2] P. H. Kuhn, A. V. Colombo, B. Schusser, D. Drey Mueller, S. Wetzel, U. Schepers, J. Herber, A. Ludwig, E. Kremmer, D. Montag, U. Müller, M. Schweizer, P. Saftig, S. Bräse, and S. F. Lichtenthaler, “Systematic substrate identification indicates a central role for the metalloprotease ADAM10 in axon targeting and synapse function,” *eLife*, vol. 5, no. e12748, 2016.

*Publications by this Focus Group can also be found in the section Publications of this report.*

# Focus Group **Brain Temperature Control of Metabolic Diseases**

Prof. Tamas Horvath (Yale University) | Hans Fischer Senior Fellow  
Tim Gruber (TUM) | Doctoral Candidate

## Scientific Reports



Tamas Horvath

### Host

Prof. Matthias Tschöp  
Metabolic Diseases,  
TUM

### 1 | 3DISCO-assisted fluorescent angiography of the hypothalamus.

Mouse brains were first perfused with a fluorescent vessel tracer (lectin-FITC) before undergoing organic solvent-based tissue clearing (3DISCO). Translucent brains were imaged three-dimensionally using a light-sheet fluorescent microscope in collaboration with Dr. Ali Ertürk (LMU) Scalebar = 300  $\mu$ m.

## The brain vasculature in metabolic disease: targeting the glia-vascular interface for the treatment of obesity

The prevalence of obesity and type 2 diabetes has been increasing at an alarming rate worldwide over the past few decades. Despite considerable efforts aimed at prevention and treatment, the obesity epidemic continues to grow. Among various other comorbidities, overweight and obese individuals are especially predisposed to developing vascular pathologies that may ultimately lead to severe disabilities or even death [2]. Obesity-related vasculopathies also affect the brain, and therefore represent a potential cause for an increased risk for stroke, dementia and neurodegeneration in the obese and diabetic [3]. Neovascularization within the retina of the eye is another prominent complication of diabetes, constituting the leading cause for blindness in the working-age population in the United States [6]. We were the first to describe that a high-calorie diet exposure induces a similar hypervascularization syndrome within a distinct brain region that regulates body weight [4]. Currently, we are investigating the underlying mechanisms, its impact on health and putative therapeutic options.

Chronic high-calorie diet exposure induces a phenomenon referred to as “hypothalamic angiopathy.” As observed in both animal models and humans, this event is characterized by the excessive formation of abnormal, hyperpermeable blood vessels in the hypothalamus. This leaky vasculature consequently drives the innate immune response within the brain, and eventually contributes to systemic metabolic disorders, neuronal dysfunction and neurodegeneration.

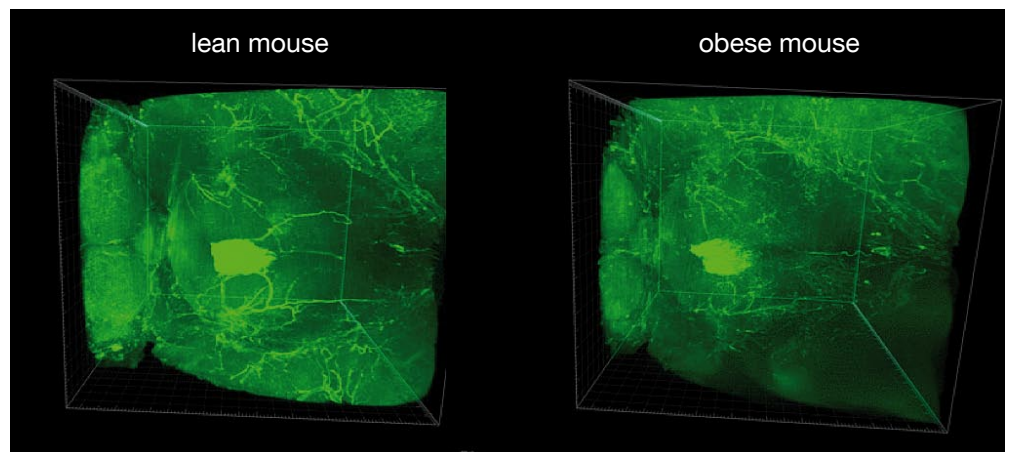

In order to identify which mechanisms are involved in the regulation of this pathologic vascularization, we interrogated the role of astrocytes as part of the neurovascular system together with endothelial cells and pericytes in the rearrangement of vascularity induced by a high-fat diet. Astrocytes are star-shaped glial cells that are situated between neurons and blood vessels. They are therefore in an ideal location to sense and regulate metabolic processes within the brain. Our group hypothesized that the excessive intake of a high-caloric diet (overload of energy substrates) might increase cellular respiration, which limits local oxygen consumption within distinct

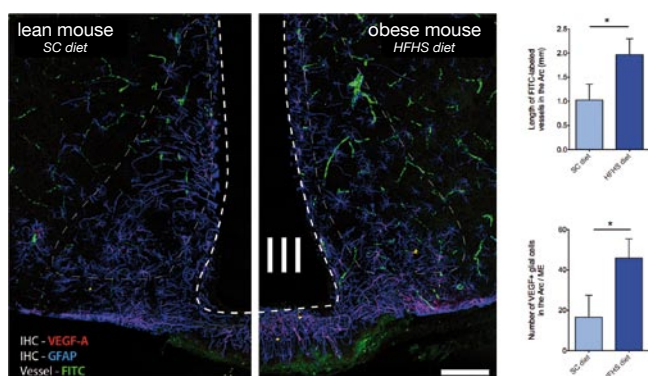

## 2 | High-fat-diet-induced up-regulation of VEGF-A in glial cells of the hypothalamus.

High-fat-diet-induced obese mice (HFHS diet) exhibited an increase of VEGF-A immunoreactivity in GFAP-expressing astrocytes the arcuate nucleus of the hypothalamus (lining the third ventricle) compared with lean mice on standard chow diet (SC diet). GFAP:glial-fibrillary acidic protein; Third ventricle (III). Scalebar = 100um.

brain regions and ultimately promotes the formation of new – however abnormal – blood vessels. The classical signalling pathway governing adaptation to hypoxia is known to involve a transcription factor termed “hypoxia-inducible factor” 1 $\alpha$  (HIF1 $\alpha$ ) [1], which consequently can drive the expression of angiogenic factors such as vascular-endothelial growth factor (VEGF).

In alignment with previous studies reported in diabetic retinae [5], we found a significant increase in immunoreactivity to VEGF-A in the hypothalamus of mice in response to high-fat / high-sugar feeding. Interestingly, VEGF-A co-localizes with glial fibrillary acidic protein (GFAP)-expressing cells, indicating the astroglia as the primary source for excessive VEGF-A levels. Furthermore, we found that mice lacking HIF1 $\alpha$  specifically in astrocytes (GFAP-expressing cells) entirely prevented this increase of VEGF-A as well as the angiogenic response to a high-fat diet. Currently, we are performing experiments to further investigate whether and how this astrocytic HIF1 $\alpha$ -VEGF pathway is involved in the cerebrovascular changes in response to an obesogenic diet.

## Conclusion

Sticking to the analogy with the diabetic retina, our Focus Group seeks to demonstrate if the hypothalamus can “turn blind” for metabolic feedback signals derived from the periphery – signals that usually govern bodyweight homeostasis. We expect to disentangle this diet-induced angiopathy of the obese brain by using various genetic and pharmacological interventions *in vivo* and *in vitro*.

## References

- [1] C. W. Pugh, and P. J. Ratcliffe, “Regulation of the angiogenesis by hypoxia: role of the HIF system,” *Nat. Med.*, vol. 9, no.6, pp. 677–684, 2003.
- [2] P. Pirier, T. D. Giles, G. A. Bray, Y. Hong, J. S. Stern, F. X. Pi-Sunyer, and R. H. Eckel, “Obesity and cardiovascular disease: pathophysiology, evaluation, and effect of weight loss: an update of the 1997 American Heart Association Scientific Statement on Obesity and Heart Disease from the Obesity Committee of the Council on Nutrition, Physical Activity and Metabolism,” *Circ. J.*, vol. 113, no. 6, pp. 898–918, 2006.
- [3] A. Ergul, A. Kelly-Cobbs, M. Abdalla, and S. C. Fagan, “Cerebrovascular complications of diabetes: focus on stroke,” *Endocr. Metab. Immune Disord Drug Targets*, vol. 12, no. 2, pp. 148–158, 2012.
- [4] C. Yi, M. Gericke, M. Krüger, A. Alkemade, D. Kabra, S.Hanske, J. Filosa, P. Pfluger, N. Bingham, S. Woods, J. Herman, A. Kalsbeek, M. Baumann, R. Lang, J. Stern, I. Bechmann, and M. Tschöp, “High calorie diet triggers hypothalamic angiopathy,” *Mol. Metab.*, vol. 1, no. 1–2, pp. 95–100, 2012.
- [5] R. Simo, J. Sundstrom, and D. Antonetti, “Ocular anti-VEGF therapy for diabetic retinopathy: The role of VEGF in the pathogenesis of diabetic retinopathy,” *Diabetes Care*, vol. 37, no. 4, pp. 893–899, 2014.
- [6] R. Lee, T. Y. Wong, and C. Sabanayagam, “Epidemiology of diabetic retinopathy, diabetic macular edema and related vision loss,” *Eye Vis (Lond)*, vol. 2, no 17, pp. 1–25, 2015.

## Selected Publication

- [7] C. García-Cacéres, C. Quarta, L. Varela, Y. Gao, T. Gruber, B. Legutko, M. Jastroch, P. Johansson, J. Ninkovic, C. Yi, O. Lê Thúc, K. Szigeti-Buck, W. Cai, C. Meyer, P. Pfluger, A. Fernandez, S. Luquet, S. Woods, I. Torres-Alemán, C.R. Kahn, M. Götz, T. Horvath, and M. Tschöp, “Astrocytic insulin signaling couples brain glucose uptake with nutrient availability,” *Cell*, vol. 166, no. 4, pp. 867–880, 2016.

Publications by this Focus Group can also be found in the section Publications of this report.

# Focus Group **MicroRNAs Regulating Diabetes and Obesity**

Prof. Klaus Kästner (Pennsylvania Perelman School of Medicine)

Hans Fischer Senior Fellow

Verena Ott (TUM) | Doctoral Candidate

Scientific Reports



Klaus Kästner

© Host

Prof. Matthias Tschöp  
Metabolic Diseases,  
TUM

## MiRNA-mediated control of immune activation in diabetes and obesity

The goal of our interdisciplinary Focus Group is to understand the cellular and molecular mechanisms underlying the induction of immune tolerance in diabetes and obesity. Europe and the U.S. are facing a dramatic increase in the incidence of autoimmune type 1 diabetes (T1D), the rate of which is doubling every 20 years in young children. Moreover, the epidemic of obesity and type 2 diabetes (T2D) represents one of the most severe health threats of modern society.

CD4<sup>+</sup>CD25<sup>+</sup>Foxp3<sup>+</sup>regulatory T cells (Tregs) function as a subset of T cells and are pivotal in maintaining immune tolerance and controlling inflammatory processes, thereby contributing to tissue homeostasis. To develop innovative strategies that can interfere with autoimmune progression or inflammation in diabetes, a mechanistic understanding of cellular and molecular components that can impede immune tolerance is needed.

MicroRNAs (miRNAs) are a class of evolutionarily conserved, small non-coding RNAs that control gene expression by targeting mRNAs for degradation or translational repression, which is an important regulatory principle in the mammalian immune system. miRNAs impact, in a dose-dependent manner, cellular states or responses such as T cell activation, Treg cell function and fitness by regulating hundreds of proteins simultaneously. However, our understanding of the role of individual miRNAs for immune activation versus regulation is in its infancy, especially in the context of inflammatory states such as obesity and diabetes. We know even less about the critical downstream targets of miRNAs that impact T cell activation and thereby impinge on the complex immunological interplay triggering immune activation and inflammation.

Our group recently demonstrated that during the onset of islet autoimmunity – prior to the clinical manifestation of T1D – an insulin-specific target cell population was enriched with a T follicular helper (TFH) precursor cell phenotype. TFH cells support high-affinity and long-term antibody responses by supporting B cells. Moreover, excessive TFH cell activity has the ability to promote a breakdown of immune regulation, which in turn fosters autoimmune reactions. During the onset of islet autoimmunity, the frequency of TFH precursors was controlled by high expression of miRNA92a. miRNA92a-mediated TFH precursor induction was regulated by PTEN-PI3K-signaling, involving PTEN and Foxo1, supporting autoantibody generation and triggering the onset of islet autoimmunity. Additionally, we were able to provide evidence for KLF2 as a target of miRNA92a in regulating human TFH precursor induction. *In vivo* application of an miRNA92a antagomir significantly reduced immune infiltration and activation in pancreata of NOD mice as well as humanized mice, while also enhancing the frequencies of local Foxp3<sup>+</sup>Tregs directly in the pancreas.

Chronic, low-grade inflammation of visceral adipose tissue – at the systemic level – provides a critical link between the aforementioned dramatic increase in the incidence of obesity and T2D. We have been able to provide the first evidence that cells with a TFH cell precursor phenotype might be involved in these inflammatory processes, because both their numbers and their de novo induction were increased in T cells from obese individuals. The observed increase in TFH frequency was accompanied by an increased abundance of miRNA92a in CD4<sup>+</sup>T cells from obese individuals and those with T2D. Furthermore, we found tissue-specific Foxp3<sup>+</sup>Tregs and their induction to be decreased upon high caloric challenges in mice.

These preliminary findings support a potential role of TFH cells and their regulation by miRNA92a in initiating islet autoimmunity in T1D and/or promoting inflammation in obesity and T2D. Through our research, we have been able to provide initial insights into the role of miRNA92a in targeting Pten and KLF2 signalling in CD4<sup>+</sup>T cells. However, the relevant downstream targets of miRNAs that can impact T cell activation versus T cell tolerance induction – and thereby impinge on the complex immunological interplay triggering progression of islet autoimmunity or inflammation in diabetes – remain largely unknown. Recent X-ray crystal structures of an Ago-miRNA-mRNA ternary complex suggest that Ago may make sufficiently close contacts to permit Ago HITS-Clip to simultaneously identify Ago-bound miRNAs and the nearby mRNA sites, thus allowing the definition of the sites of Ago interaction *in vivo*.

To identify which miRNAs participate in the regulation of human T cell activation during immune activation in diabetes and obesity – and to identify their mRNA targets – we have now made use of this technique: UV-cross-linked miRNAs:mRNA complexes are immune-precipitated with an antibody to Argonaute, an essential component of the RISC, and then subjected to deep sequencing analyses. Analyses of respective miRNAs:mRNA target relationships are currently ongoing.

Additionally, we are now employing both gain- and loss-of-function models for miRNA92a to dissect the cellular and molecular mechanisms that underlie the role of TFH cells in interfering with T cell tolerance induction in diabetes and obesity. Overall, our studies promise to open the way for the development of novel precision medicines that synergistically target metabolism, immune activation and inflammation to treat obesity and diabetes.

*This work was conducted in close cooperation with Dr. Carolin Daniel (Institute of Diabetes Research, Helmholtz Zentrum München).*

#### Reference

- [1] V. Kameswaran, et al., “Epigenetic regulation of the DLK1-MEG3 microRNA cluster in human type 2 diabetic islets,” *Cell Metab.*, vol. 19, no. 1, pp.135–145, 2014.

#### Selected Publications

- [2] I. Serr, R. W. Fürst, V. B. Ott, M. G. Scherm, A. Nikolaev, F. Gökmen, S. Kälin, S. Zillmer, M. Bunk, B. Weigmann, N. Kunschke, B. Loretz, C. M. Lehr, B. Kirchner, B. Haase, M.W. Pfaffl, A. Waisman, R. A. Willis, A. G. Ziegler, and C. Daniel, “MiRNA92a targets KLF2 and PTEN signaling to promote human T follicular helper precursors in T1D islet autoimmunity,” *PNAS* 2016, vol. 113, no.43, pp. E6659-E6668, 2016.
- [3] Y. J. Wang, M. L. Golson, J. Schug, D. Traum, C. Liu, K. Vivek, C. Dorrell, A. Naji, A. C. Powers, K.M. Chang, M. Grompe, K. H. Kaestner, “Single-cell mass cytometry analysis of the human endocrine pancreas,” *Cell Metab.*, vol. 24, no. 4, pp. 616–626, 2016.

*Publications by this Focus Group can also be found in the section Publications of this report.*

## Focus Group Proteomics

Dr. Peer-Hendrik Kuhn (TUM) | Carl von Linde Junior Fellow  
Alperen Serdaroglu (TUM) | Doctoral Candidate

### Scientific Reports



Peer-Hendrik Kuhn

### © Hosts

Prof. Stefan Lichtenthaler  
Neuroproteomics, TUM,  
Prof. Wilko Weichert  
Pathology, TUM

2016 was an eventful year and turning point for our Focus Group. We completely relocated our laboratory from Großhadern in the south of Munich to the university hospital Klinikum rechts der Isar at the heart of the city. In the midst of the big move, we successfully set up a working lab in our new environment while simultaneously continuing – unabated – with our research and the publication of several papers.

Our current focus is the investigation of changes in the secretome and the cell surface proteome of cells in physiological and pathophysiological settings. The secretome is the entirety of all secreted factors of cells, and the cell surface proteome comprises all proteins displayed on the cell membrane. Both are indispensable for the organization and function of multicellular organisms. Alterations in the secretome or the cell surface proteome contribute to the pathogenesis of many diseases, including cancer, vascular, autoimmune and neurodegenerative disorders such as Alzheimer's disease. However, the molecular changes in the secretome and surface proteome that occur in these diseases are hardly investigated.

In our research, we have developed the enrichment of secretome protein with the click sugars (SPECS) method, which enables an unbiased analysis of the secretome and, in turn, assists with the identification of perturbation in the secretome. Over the past year, we extended the SPECS method to the cell surface proteome called surface SPECS. Using surface SPECS, we were able to establish a link between TDP43 expression and expression of the cell survival promoting receptor tyrosine kinases ERBB4 and c-met providing evidence for a link between a TDP43 loss-of-function and decreased neuronal health in Frontotemporal lobar degeneration (FTLD) and amyotrophic lateral sclerosis (ALS) [1].

We also investigated the function of the metalloprotease ADAM10 in primary neurons and rodent brains. ADAM10 is of interest due to its ability to prevent Amyloid- $\beta$  ( $A\beta$ ) generation, which is considered the cause of neuronal death in Alzheimer's disease. As protease function is defined by its substrates, we applied SPECS to ADAM10 substrates identification in neurons (figure 1). We could identify a large number of new ADAM10 substrates such as NrCAM, neuroligins, LDL receptors and other membrane proteins, and additionally confirm previously identified substrates such as N-Cadherin [2]. Our data demonstrate that ADAM10 is a promiscuous protease with many substrates involved in many physiological processes such as synapse function and axon guidance in the central nervous system. It therefore might be difficult to use it as a drug target in Alzheimer's disease.

Using the strong neuroscience background within our Focus Group as a basis, we decided to apply SPECS to new research fields, such as cancer, that offer a new "playground" for SPECS: We also considered that applying SPECS in new areas would improve the method further to make it even more sensitive. Alperen Serdaroglu, a doctoral candidate working in our Focus Group, optimized various parameters of the SPECS method such as pH, buffer composition and the respective alkyne reagent. Ultimately, this work resulted in the strong improvement in the identification of glycoproteins in the secretome [3].



We are also currently applying SPECS to learn more about drug resistance mechanisms in acute myeloid leukemia – a malignancy of myeloid progenitor cells. Whereas myeloid progenitor cells give rise to most corpuscular blood elements under physiological conditions – such as erythrocytes or granulocytes – in AML myeloid, progenitors divide indefinitely and do not mature into healthy blood components. The internal tandem duplication of the juxtamembrane region of FLT3 (FLT3itd) is a frequent mutation in AML, which leads to constitutive FLT3 signaling and, as a result, the increased proliferation and survival of AML cells. This mutation can be treated with the multi-tyrosine kinase inhibitor, Sorafenib. However, the effectivity of Sorafenib treatment in AML is only of short duration due to resistance development. Studying the changes that occur in the secretome and the surface proteome during treatment with Sorafenib over a longer duration, we aim to identify epigenetic Sorafenib resistance mechanisms in AML cell lines and patients that might result in novel treatment options in the future.

### Selected Publications

- [1] P.-H. Kuhn, A. V. Colombo, B. Schusser, D. Dreytmueller, S. Wetzels, U. Schepers, J. Herber, A. Ludwig, E. Kremmer, D. Montag, U. Muller, M. Schweizer, P. Saftig, S. Brase, and S. F. Lichtenthaler, “Systematic substrate identification indicates a central role for the metalloprotease ADAM10 in axon targeting and synapse function,” *eLife*, vol. 5, no. e12748, 2016.
- [2] B. M. Schwenk, H. Hartmann, A. Serdaroğlu, M. H. Schludi, D. Hornburg, F. Meissner, D. Orozco, A. Colombo, S. Tahirovic, M. Michaelsen, F. Schreiber, S. Haupt, M. Peitz, O. Brustle, C. Kupper, T. Klopstock, M. Otto, A. C. Ludolph, T. Arzberger, P.H. Kuhn, and D. Edbauer, “TDP-43 loss of function inhibits endosomal trafficking and alters trophic signaling in neurons,” *EMBO J.*, vol. 35, no. 21, pp. 2350–2370, 2016.
- [3] A. Serdaroğlu, S. A. Muller, U. Schepers, S. Brase, W. Weichert, S. F. Lichtenthaler, and P. H. Kuhn, “An optimised version of the secretome protein enrichment with click sugars (SPECS) method leads to enhanced coverage of the secretome,” *Proteomics*, no. 1600423, 2016.

*Publications by this Focus Group can also be found in the section Publications of this report.*

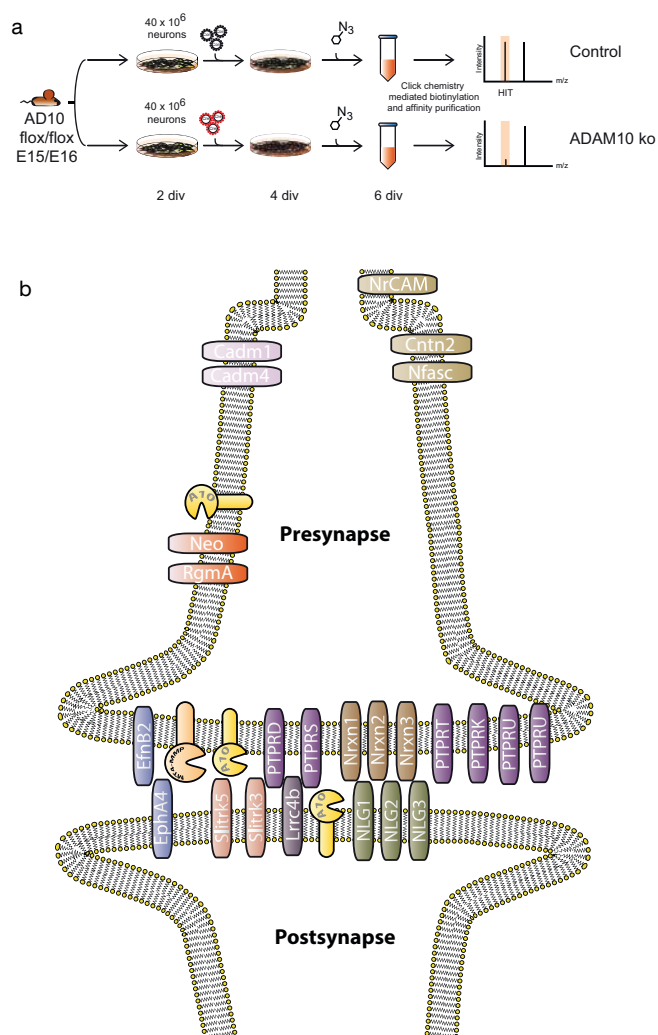

1 | (a) Strategy using SPECS to identify ADAM10 substrates in neurons. (b) Synapse with exemplary ADAM10 substrates and their location at the synapse.

## Focus Group **Viral Hepatitis**

Prof. Jane McKeating (University of Birmingham) | Hans Fischer Senior Fellow  
Anindita Chakraborty, Lisa Wolff (TUM) | Doctoral Candidates

### Scientific Reports



Jane McKeating

### © Host

Prof. Ulrike Protzer

Virology, TUM

Chronic hepatitis B and C virus infection is a global health problem with infected individuals at risk of developing liver disease that can progress to hepatocellular carcinoma. While hepatitis B virus (HBV) is a DNA virus relatively well conserved, hepatitis C virus (HCV) is an RNA virus that exists as a quasispecies of related genomes that are under continuous selection by host immune responses and antiviral drug therapy. The primary site of HBV and HCV replication is the liver and yet our understanding of the spatial distribution of viral variants within the liver as well as host mechanisms restricting virus spread is limited.

HCV infected hepatocytes occur as foci surrounded by uninfected cells supporting a model of viral compartmentalization. Recent reports show interferon stimulated gene (ISG) expression in chronic hepatitis C and we hypothesized that local interferon responses may limit viral replication and evolution. To investigate the spatial influence of the liver architecture on viral replication we measured HCV RNA and ISG mRNA from multiple segments of the liver (figure). HCV RNA and ISG mRNA levels were comparable across all sites from an individual liver but showed up to 500-fold difference between patients. Importantly, there was no association between ISG and HCV RNA expression across all sites in the liver or plasma. Furthermore, sequencing HCV genomes from the different hepatic sites showed a similar distribution of viral quasispecies across the liver and uniform sequence diversity. Importantly, there were no differences between the hepatic and plasma viral quasispecies in all patients. Our study shows that the genetic pool of HCV envelope sequences is indistinguishable between distant sites in the liver and plasma, arguing against viral compartmentalization that impacts on our understanding and modeling of viral diversity in chronic disease [3].

For HBV much less is known about virus uptake and release from infected cells since broadly usable cell culture infection models only recently became available when the bile acid transporter Na<sup>+</sup>-taurocholate cotransporting polypeptide (NTCP) was identified as primary uptake receptor. Together with scientists from the Academic Medical Center in Amsterdam, The Netherlands, Anindita Chakraborty, a doctoral candidate of our Focus Group, was able to decipher the role of protein modification on NTCP for bile acid as well as for virus uptake. NTCP contains two N-linked glycosylation sites and we mutated asparagine amino acid residues to a glutamine to generate NTCP with a single glycan or no glycans. Neither the physiological function of NTCP, the uptake of bile acids, nor the uptake of HBV was affected in cells expressing single glycosylation variants. However, glycosylation-deficient NTCP failed to transport bile acids or support HBV infection and showed no membrane localization. We conclude that N-glycosylation is required for efficient NTCP localization at the plasma membrane and subsequent HBV infection and these characteristics are preserved in NTCP carrying a single carbohydrate moiety [1].

Clinical studies show increased expression of Autotaxin (ATX), a phospholipase with diverse roles in physiological and pathological processes including inflammation and oncogenesis, in chronic hepatitis C. However, the pathways regulating ATX and its role in the viral life cycle are not defined and this year we published a seminal study on the role of ATX in HCV-associated hepatocellular carcinoma.

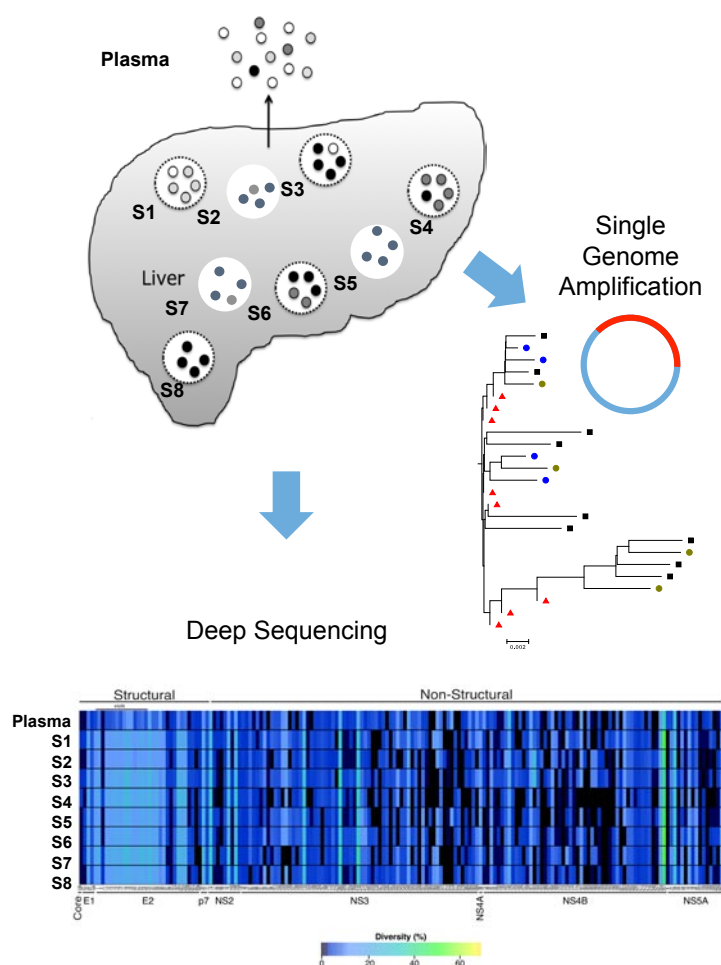

*In vitro* studies confirmed that HCV increased hepatocellular ATX RNA and protein expression. HCV infection stabilizes hypoxia inducible factors (HIFs) and we investigated a role for these transcription factors to regulate ATX. Low oxygen regulates ATX expression and transcriptome analysis of tumor and adjacent non-tumor tissue demonstrated a positive correlation between ATX mRNA levels and hypoxia gene score. Importantly, inhibiting ATX-lysophosphatidic acid signalling reduced HCV replication, highlighting a positive role for this phospholipase in the viral life cycle. Lysophosphatidic acid activates phosphoinositide-3-kinase that in turn stabilizes HIF-1 $\alpha$  and inhibiting HIF-signalling abrogates the pro-viral activity of LPA. Our data support a model where HCV infection increases ATX expression that potentiates an autocrine pathway that drives viral replication. This study identifies the ATX-LPA axis as a new therapeutic target for the treatment of hepatocellular carcinoma [2].

To clear virus infection is the final goal of any therapeutic effort. Viral clearance involves immune cell cytotoxicity of infected cells. However, studies of hepatitis B virus (HBV) infection in chimpanzees have indicated that cytokines released by T cells can also promote viral clearance via non-cytolytic processes. We aimed at identifying the non-cytolytic mechanisms by which T cells eliminate HBV and in particular its persistence form, cccDNA, from infected hepatocytes [4]. In serum samples from patients with acute and chronic hepatitis B, we found that levels of antiviral

cytokines IFN $\gamma$  and TNF $\alpha$  were increased. In human hepatocytes with continuously replicating HBV, as well as in HBV-infected primary human hepatocytes or HepaRG cells, IFN $\gamma$  and TNF $\alpha$  each induced deamination of cccDNA and interfered with its stability. Interestingly, HBV-specific T cells, through secretion of IFN $\gamma$  and TNF $\alpha$ , inhibited HBV replication and reduced cccDNA in infected cells without the direct contact required for cytolysis. Blocking IFN $\gamma$  and TNF $\alpha$  after T-cell stimulation prevented the loss of cccDNA. Deprivation of cccDNA required activation of nuclear APOBEC3 deaminases by the cytokines that modified cccDNA. In liver biopsies from patients with acute hepatitis B, but not chronic hepatitis B or controls, hepatocytes expressed APOBEC3A and APOBEC3B. This study [4] proved that IFN $\gamma$  and TNF $\alpha$ , produced by T cells, are able to reduce levels of HBV cccDNA in hepatocytes by inducing deamination and subsequent cccDNA decay. This has important consequences for immune therapies, since immune cells apparently do not require to destroy all infected cells but can also clear the infection by secretion of cytokines.

Together with Universities of Heidelberg and Freiburg, we were able to secure funding of a collaborative research center from the German Research Foundation (TRR179 on Viral Hepatitis). Finally, our Hans Fischer Senior Fellow Jane McKeating was granted an Investigator award from the Wellcome Trust, the most competitive and prestigious award in the UK and will be relocating to the Nuffield Department of Medicine, University of Oxford, early 2017.

#### References

- [1] M. D. Appelman, A. Chakraborty, U. Protzer, J. A. McKeating, and S. F. J. van de Graaf, "N-glycosylation of the Na<sup>+</sup>-taurocholate Co-transporting Polypeptide (NTCP) determines its trafficking and stability and is required for hepatitis type B virus entry," *PLoS One*, vol. 12, no. 1, pp. e0170419, 2017.
- [2] M. Farquhar, I. Humphreys, S. A. Rudge, G. Wilson, B. Bhattacharya, M. Ciaccia, K. Hu, Q. Zhang, L. Maily, G. Reynolds, M. Ashcroft, P. Balfe, T. F. Baumert, S. Roessler, M. J. O. Wakelam, and J. A. McKeating, "Autotaxin-lysophosphatidic acid receptor signalling regulates hepatitis C virus replication," *J. Hepatol.*, 2017, in press.

#### Selected Publications

- [3] D. L. Hedegaard, D. C. Tully, I. A. Rowe, G. M. Reynolds, K. Hu, C. Davis, A. Wilhem, C. B. Ogilvie, K. A. Power, A. Tarr, D. Kelly, T. M. Allen, P. Balfe, and J. A. McKeating, "High resolution sequencing of hepatitis C virus reveals limited intra-hepatic compartmentalization during late stage liver disease," *J. Hepatol.*, vol. 66, no. 1, pp. 28–38, 2017, accepted in 2016.
- [4] Y. Xia, D. Stadler, J. Lucifora, F. Reisinger, D. Webb, M. Hösel, T. Michler, K. Wisskirchen, X. Cheng, K. Zhang, W.-M. Chao, J. Wettengel, A. Malo, F. Bohne, D. Hoffmann, F. Eyer, R. Thimme, W. E. Thasler, M. Heikenwalder, and U. Protzer, "Interferon- $\gamma$  and tumor necrosis factor- $\alpha$  produced by T cells reduce the HBV persistence form, cccDNA, without Cytolysis," *Gastroenterology*, vol. 150, no. 1, pp. 194–202, 2016.

*Publications by this Focus Group can also be found in the section Publications of this report.*

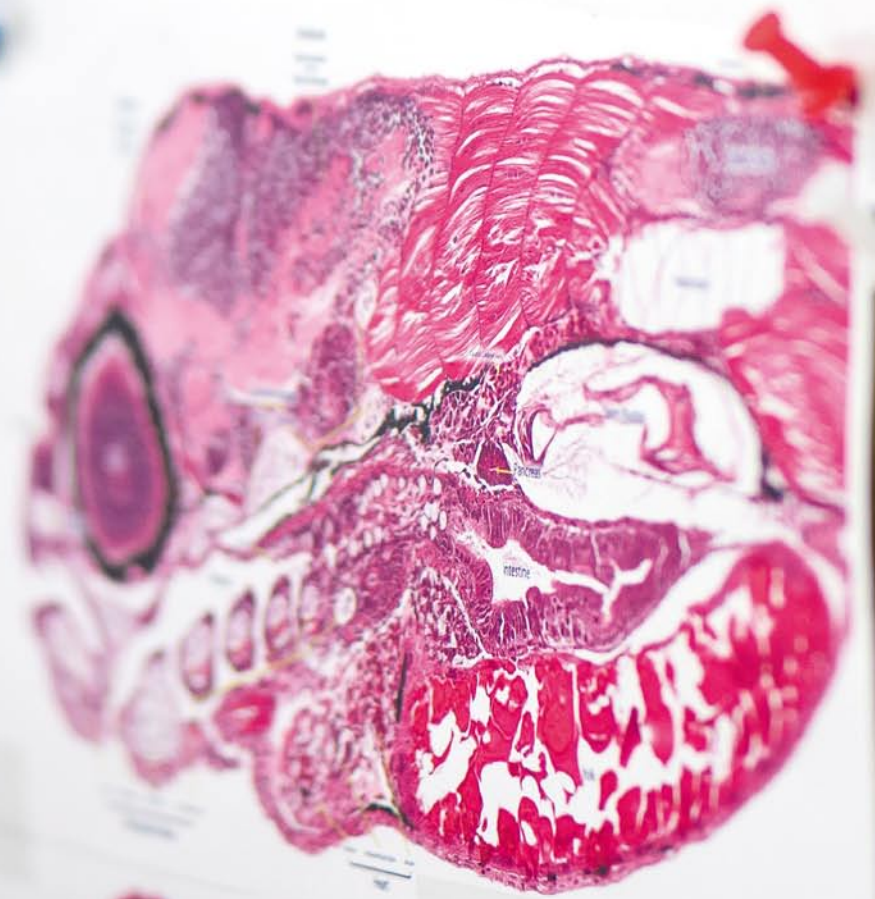

# Focus Group Clinical Cell Processing and Purification

Prof. Stanley Riddell (University of Washington) | Hans Fischer Senior Fellow  
Simon Fräßle, Manuel Effenberger (TUM) | Doctoral Candidates

## Scientific Reports



Stanley Riddell

### © Host

Prof. Dirk Busch

Medical Microbiology,  
Immunology and  
Hygiene, TUM

The goal of our Focus Group Clinical Cell Processing and Purification is to develop advanced, user-friendly, and integrated cell processing platforms to facilitate the preparation of effective and minimally manipulated therapeutic cells for highly individualized medical care. In the past, studies performed by Focus Group members have elucidated fundamental properties of T cells that provide superior functionality and persistence, and a novel safety switch that serves dual functions in cell selection and elimination was defined. In collaboration with Stanley Riddell, Hans Fischer Senior Fellow, first in-human clinical trials of novel cell therapies using Focus Group innovations have been started in Seattle to evaluate safety and efficacy.

## Development of safeguard strategies for adoptive immunotherapy using genetically engineered T cells

Over the past few years, excitement has been growing for immunotherapies utilizing a patient's own immune system to combat certain types of cancer. One approach to immunotherapy is called adoptive cell transfer (ACT), which can, for example, be achieved by genetic modification of patient-derived immune cells: this is accomplished by introducing a tumor-specific receptor to recognize and attack cancer.

Within our Focus Group, we have explored methods to rapidly select defined T cell subsets for clinical applications. Thereby, so-called "central memory T cells" (TCMs) were identified to be of special relevance for ACT, as they can engraft, expand and persist long-term, even at very low numbers of transferred T cells. TCMs can be genetically engineered to express novel antigen-targeting receptors, such as natural T cell receptors (TCRs) or chimeric antigen receptors (CARs) without affecting their *in vivo* behavior. Stanley Riddell, Hans Fischer Senior Fellow and recently elected as TUM Ambassador in this Focus Group, has initiated in Seattle clinical trials in which the patient's T cells are genetically modified to express a synthetic chimeric antigen receptor (CAR) specific for the CD19 B-cell lineage molecule that is expressed on B cell leukemias and lymphomas. The modular structure of CARs allows the combination of antibody-like specificities with the signaling characteristics of a TCR. This therapy induces complete remissions in >80% of patients with chemotherapy-refractory B cell acute lymphocytic leukemia (ALL) and complete or partial responses in >70% of patients with non-Hodgkin's lymphoma. A complication of this therapy is that the CAR-T cells also eliminate normal B cells that express the CD19 molecule, which if prolonged, results in a deficiency in antibody production.

In order to improve the quality and safety of gene-modified T cells for therapy, cointegration of safeguard mechanisms that allow selective elimination of transferred cells in the event of side effects represents a promising strategy. Such a safeguard has to be stably coexpressed with the recombinant receptor, and should be non-immunogenic to allow long-term survival of transferred cells. Therefore, we explored coexpression of a truncated Epidermal Growth Factor Receptor (EGFRt) that is functionally inert as a safeguard for gene-modified T cells. For *in vivo* depletion, the EGFRt marker can be specifically targeted by the clinically approved  $\alpha$ EGFR mAb (Cetuximab), which mediates antibody-dependent cellular cytotoxicity (ADCC). Our *in vivo* studies in preclinical mouse experiments demonstrate first proof-of-concept that this approach allows to selectively eliminate mouse CD19-CAR engineered T cells by Cetuximab treatment, thereby reversing B cell aplasia, a long-term anti-CD19-CAR T cell-mediated toxicity. Since Cetuximab treatment might not be applicable during acute toxicities with strong inflammatory components, we are currently developing alternative safeguard mechanisms.

#### Selected Publications

- [1] P. J. Paszkiewicz, S.P. Fraessle, S. Srivastava, D. Sommermeyer, M. Hudecek, I. Drexler, M. Sadelain, L. Liu, M.C. Jensen, S.R. Riddell, and D. H. Busch, "Targeted antibody-mediated depletion of murine CD19 CAR T cells permanently reverses B cell aplasia," *J Clin Invest* 126, pp. 4262–4272 (2016).
- [2] M. Nauerth, C. Stemberger, F. Mohr, B. Weissbrich, M. Schiemann, L. Germeroth, and D. H. Busch, "Flow cytometry-based TCR-ligand Koff -rate assay for fast avidity screening of even very small antigen-specific T cell populations *ex vivo*," *Cytometry A* 89, pp. 816–825 (2016).
- [3] K. Schober, and D. H. Busch, "A synergistic combination: using RNAseq to decipher both T-cell receptor sequence and transcriptional profile of individual T cells," *Immunol Cell Biol* 94, pp. 529–530 (2016).
- [4] C. J. Turtle, L. A. Hanafi, C. Berger, T. A. Gooley, S. Cherian, M. Hudecek, D. Sommermeyer, K. Melville, B. Pender, T. M. Budiarto, E. Robinson, N. N. Steevens, C. Chaney, L. Soma, X. Chen, C. Yeung, B. Wood, D. Li, J. Cao, S. Heimfeld, M. C. Jensen, S. R. Riddell, and D. G. Maloney, "CD19 CAR-T cells of defined CD4+:CD8+ composition in adult B cell ALL patients," *J Clin Invest* 126, pp. 2123–2138 (2016).
- [5] K. Schober, and D. H. Busch, "TIL 2.0: More effective and predictive T-cell products by enrichment for defined antigen specificities." *Eur J Immunol* 46, pp. 1335–1339 (2016).
- [6] L. Liu, D. Sommermeyer, A. Cabanov, P. Kosasih, T. Hill and S. R. Riddell, "Inclusion of Strep-tagII in design of antigen receptors for T-cell immunotherapy," *Nat Biotechnol* 34, pp. 430–434 (2016).
- [7] D. H. Busch, S. P. Fraessle, D. Sommermeyer, V. R. Buchholz, and S. R. Riddell, "Role of memory T cell subsets for adoptive immunotherapy," *Semin Immunol* 28, pp. 28–34 (2016).
- [8] D. Sommermeyer, M. Hudecek, P. L. Kosasih, T. Gogishvili, D. G. Maloney, C. J. Turtle, and S. R. Riddell, "Chimeric antigen receptor-modified T cells derived from defined CD8+ and CD4+ subsets confer superior antitumor reactivity *in vivo*," *Leukemia* 30, pp. 492–500 (2016).

*Publications by this Focus Group can also be found in the section Publications of this report.*

## Focus Group **Functional Interfaces**

Prof. Matthias Batzill (University of South Florida) | Hans Fischer Fellow  
Yuanqin He (TUM) | Doctoral Candidate

### Scientific Reports



Matthias Batzill

© Host

Prof. Johannes Barth  
Molecular Nanoscience  
and Chemical  
Physics of Interfaces,  
TUM

### Edge functionalization of graphene

Porphyrins are versatile molecules that – beyond their relevance in natural systems – can be adapted for various technological applications such as molecular electronics, gas sensing, and light harvesting. Combining the properties of porphyrins with the high physical strength and charge mobility of graphene, a single atomic layer of carbon in a  $sp^2$  honeycomb structure, can enable complex hierarchical architectures and the design of novel functional materials. In a previous study, we proposed the concept of a general procedure of on-surface covalent linking of porphyrins to heteromaterials, and in particular to  $sp^2$  carbon sites at graphene edges [1, 2]. Within the TUM-IAS project we could directly demonstrate that this strategy is indeed viable and introduces versatile avenues towards hybrid molecular architectures. Non-contact atomic force microscopy (nc-AFM) with a CO-functionalized probe directly visualizes the chemical bonding between porphyrins and graphene edges [3].

After demonstrating the proof-of-principle for the synthesis of complex molecular heterostructures by on-surface covalent linking, we further explored the methodology of functionalizing graphene-based nanostructures with porphyrins to generate scalable materials with application potential. Firstly, monolayer graphene grown on copper foil is etched under hydrogen gas flow to expose graphene edges. Subsequently, the graphene layer featuring a nanoporous structure is transferred onto a target-substrate, which favors interfacial homocoupling reactions, e.g., Au(111). In the last step, porphyrins are deposited that covalently fuse to the exposed graphene edges. To generalize the approach and at the same time to gain deeper understanding of the properties of these heterostructures, porphyrins are also coupled to graphene nanoribbons with well-defined edge terminations, i.e., zigzag or armchair. With this arrangement, both the preference of the coupling configuration and changes of electronic properties can be explored quantitatively by scanning tunneling microscopy (STM).

The functionalization of graphene is of great importance in the development of / towards graphene-based applications. The chemical coupling of graphene with functional molecules is a promising method for achieving this. A better understanding and control of this process may lead to the precise linking of, for example, electric leads (graphene) to single molecules for use in molecular electronics, or the attachment of photo-responsive dye molecules for energy harvesting or conversions.

*In close collaboration with Willi Auwärter (Molecular Engineering at Functional Interfaces, TUM).*



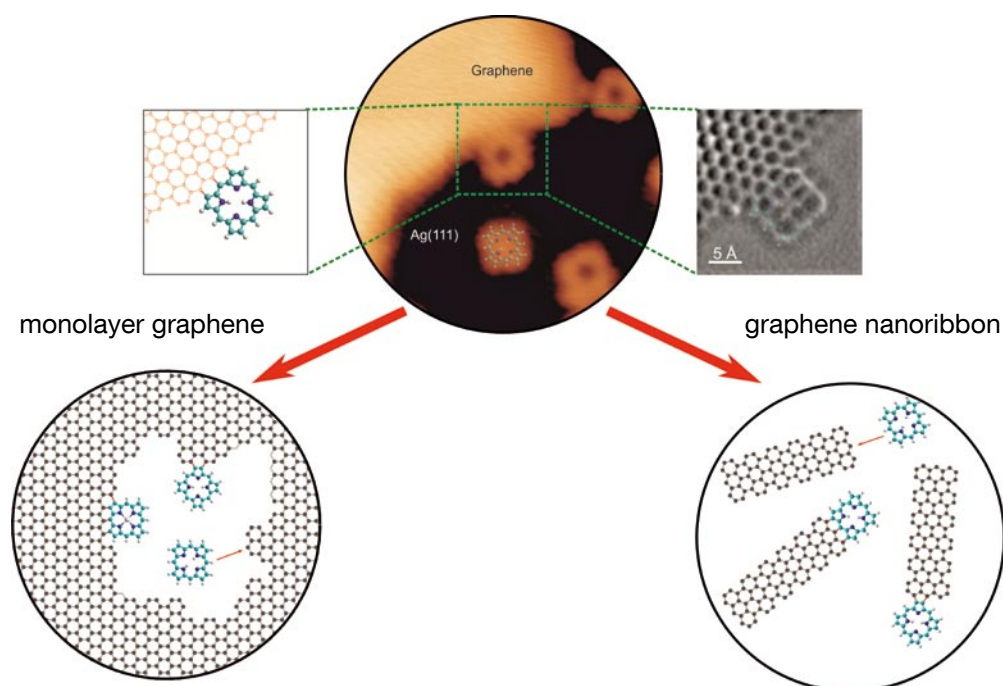

### 1 | Functionalization of graphene edges and nanoribbons

Top: STM image showing a porphine molecule coupled to a graphene zig-zag edge (marked with green square). Model and Laplace-filtered nc-AFM image of a porphine forming three C-C bonds illustrate atomistic details. Bottom left: Schematic model illustrating the monolayer graphene functionalized with porphine within etched holes. Bottom right: Schematic model illustrating the coupling between porphine and graphene nanoribbons.

### References

- [1] A. Wiengarten, K. Seufert, W. Auwärter, D. Ecija, K. Diller, F. Allegretti, F. Bischoff, S. Fischer, D. A. Duncan, A. C. Papageorgiou, F. Klappenberger, R. G. Acres, T. H. Ngo, and J. V. Barth, "Surface-assisted dehydrogenative homocoupling of porphine molecules," *J. Am. Chem. Soc.*, vol. 136, no. 26, pp. 9346–9354, 2014.
- [2] M. Batzill, "The surface science of graphene: Metal interfaces, CVD synthesis, nanoribbons, chemical modifications, and defects," *Surface Science Reports*, vol. 67, pp. 83–115, 2012.

### Selected Publications

- [3] Y. He, M. Garnica, J. Ducke, F. Bischoff, M. Bocquet, M. Batzill, W. Auwärter, and J. V. Barth, "Fusing tetrapyrroles to graphene edges by surface-assisted covalent coupling," *Nature Chemistry*, vol. 9, pp. 33–38, 2017, accepted in 2016.
- [4] M. Garnica, M. Schwarz, J. Ducke, Y. He, F. Bischoff, J. V. Barth, W. Auwärter, and D. Stradi, "Comparative study of the interfaces of graphene and hexagonal boron nitride with silver," *Physical Review. B*, vol. 94, no. 15, p. 155431, 2016.

*Publications by this Focus Group can also be found in the section Publications of this report.*

# Focus Group **Collective Quantum Dynamics**

Prof. Michael Knap (TUM) | Rudolf Mößbauer Tenure Track Professor  
Dr. Markus Heyl, Dr. Johannes M. Oberreuter (TUM) | Postdoctoral Researchers  
Annabelle Bohrdt, Simon Weidinger (TUM) | Doctoral Candidates

## Scientific Reports



Michael Knap

© Host  
Collective Quantum  
Dynamics, TUM

## Collective quantum dynamics: teamwork between quantum particles

The research in our group targets a broad range of questions from the area of condensed matter theory, such as exotic quantum material, ultracold quantum gases and light-matter systems. Interactions and correlations in condensed matter systems often manifest in striking and novel properties. These properties emerge from the collective behavior of quantum particles, and cannot be understood from the perspective of a single particle alone. In that sense, quantum particles can achieve new goals by forming teams. Numerous examples of collective quantum dynamics can be found in nature, including superconductors, quantum magnets and superfluids. Our group develops both analytical and numerical techniques to elucidate the effects of strong interactions and emergent collective behavior. Another important aspect of our research is its relevance for experiments, which has fostered close collaboration with experimental groups all over the world.

## Correlated quantum systems out of equilibrium

Recent conceptual and technical progress has made it possible to prepare and explore strongly correlated, non-equilibrium quantum states of matter. The tremendous level of control and favorable time scales achieved in experiments with synthetic quantum matter such as ultracold atoms, polar molecules, and trapped ions, has shown these systems to be ideal candidates for the exploration of non-equilibrium quantum dynamics.

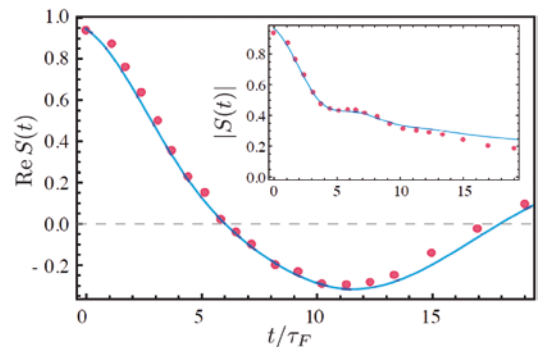

1 | Observation of the birth of a quasiparticle in real time. Blue lines are theoretical data predicted from our group.

In an earlier collaboration, our TUM-IAS group and scientists from Harvard University (USA) proposed to apply the methods typically used in extremely accurate atomic clocks to create an ultracold environment in which the formation of quasiparticles takes place in slow motion. Whereas the natural timescale of such quasiparticles in solid state systems is in the range of 100 attoseconds, the creation of polarons in this kind of systems takes several microseconds. Under these conditions, Rudolf Grimm (University of Innsbruck, Austria), together with his group, succeeded in producing a precisely controllable, many-particle system of this kind. This accomplishment facilitated the study of the birth of quasiparticles in real time (see figure 1 for a comparison of the experimental data, red dots, and our theoretical prediction, blue lines). This work was published in an issue of *Science* in 2016. The details of this work are published in [3].

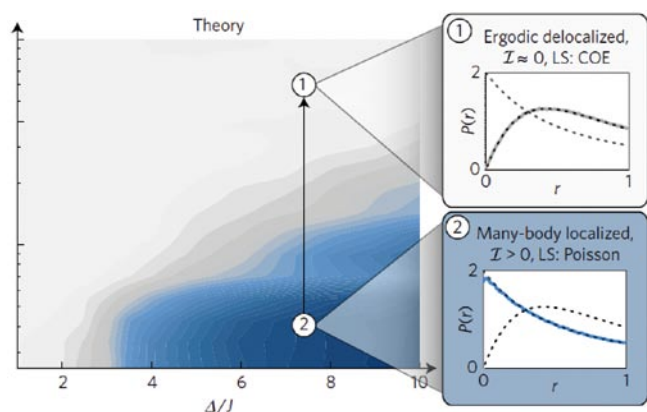

2 | Periodically driving a many-body localized quantum system.

Disorder has a drastic influence on transport properties. In the presence of a random potential, a system of interacting electrons can become insulating. This is a phenomenon known as many-body localization. However, even beyond the vanishing transport, such systems have very intriguing properties. For example, many-body localization describes an exotic phase of matter, which is robust to small changes in the microscopic Hamiltonian. Moreover, fundamental concepts of statistical mechanics break down in the many-body localized phase.

As described in a recent article in Physical Review B [4] our Focus Group studied how a many-body localized system heats up when it is driven periodically in time. The findings: When the driving frequency is below a certain threshold and the driving amplitude is large enough, the many-body localized phase gets destabilized and becomes ergodic. This is a property of the effective Floquet Hamiltonian, which governs the stroboscopic time evolution of the system. This behavior, which has previously been predicted simultaneously by a few theoretical groups, was also recently demonstrated experimentally by Immanuel Bloch's group at (Ludwig-Maximilians-Universität München and Max Planck Institute for Quantum Optics,) ([2] and figure 2). In our joint work [2], we also found an exotic regime of the MBL system, which remains remarkably stable with respect to the periodic driving. A novel question that has not been answered so far.

### Selected Publications

- [1] K. Agarwal, E. Altman, E. Demler, S. Gopalakrishnan, D. A. Huse, and M. Knap, "Rare region effects and dynamics near the many-body localization transition," *Ann. Phys.*, 2017, accepted in 2016.
- [2] P. Bordia, H. Lüschen, U. Schneider, M. Knap, and I. Bloch, "Periodically driving a many-body localized quantum system," *Nat. Phys.*, 2017, accepted in 2016.
- [3] M. Cetina, M. Jag, R. S. Lous, I. Fritsche, J. T. M. Walraven, R. Grimm, J. Levinsen, M. M. Parish, R. Schmidt, M. Knap, and E. Demler "Ultrafast many-body interferometry of impurities coupled to a Fermi sea," *Science*, vol. 354, no. 6308, pp. 96–99, 2016.
- [4] S. Gopalakrishnan, M. Knap, and E. Demler, "Regimes of heating and dynamical response in driven many-body localized systems," *Phys. Rev. B*, vol. 94, no. 9, p. 094201, 2016.

*Publications by this Focus Group can also be found in the section Publications of this report.*

# Focus Group Theory of Complex Quantum Systems

Prof. Robert König (TUM) | Rudolf Mößbauer Tenure Track Professor

Dr. Milán Mosonyi (TUM) | Postdoctoral Researcher

Martina Gschwendtner, Stefan Huber, Margret Heinze (TUM) | Doctoral Candidates

## Scientific Reports



Robert König

### © Host

Theory of Complex Quantum Systems, TUM

1 | We consider the problem of preparing ground states of topologically ordered systems of many interacting spins such as Kitaev's toric code (left). A natural interpolation procedure results in a restricted number of different final states. These depend weakly on the starting point. The figure on the right represents the so-called Bloch-sphere which visualizes the resulting encoded states.

## The physics of quantum information processing

Established in 2015, the Focus Group Complex Quantum Systems conducts research into quantum information theory, which is an interdisciplinary research field connecting physics, mathematics and computer science. We aim to assess quantum systems in terms of their information-processing potential and apply structural insights gained from quantum information theory to the study of many-body systems.

Quantum information processing holds great potential, with proposed algorithms for quantum computers giving provable speedups compared to conventional classical computing. But tapping this resource poses significant challenges, as quantum states are intrinsically fragile: Without fault-tolerance mechanisms, quantum information is invariably destroyed. Measures introducing redundancy and / or suitably isolating a system from the environment are therefore essential for realizing scalable information processing.

Our goal is to identify quantum effects which can be exploited to yield enhanced information-processing capabilities, and to characterize the exact technological requirements for doing so. We are also interested in exploiting physical insights gained from quantum information theory: considerations related to the entanglement structure of states can shed light on the behavior of complex many-body quantum systems.

## Fault-tolerant computation: initializing a quantum computer

Quantum error-correcting codes provide mechanisms for realizing robust quantum information processing. A significant challenge is the preparation of suitable initial states for computation. In recent work, we have proposed and studied a procedure whereby simple product states are gradually transformed into certain many-body states with the desired quantum correlations. This process, which we call Hamiltonian interpolation, essentially consists in adiabatically turning on the interactions associated with code stabilizers. Our numerical experiments show a certain robustness of this preparation mechanism: Even slight deviations from the initial product state yield approximately identical encoded final states. We explain this stability phenomenon by means of perturbative arguments. The latter apply to a large class of topologically ordered systems. This work therefore identifies a rather simple and potentially realizable way of initializing a topological quantum computer.

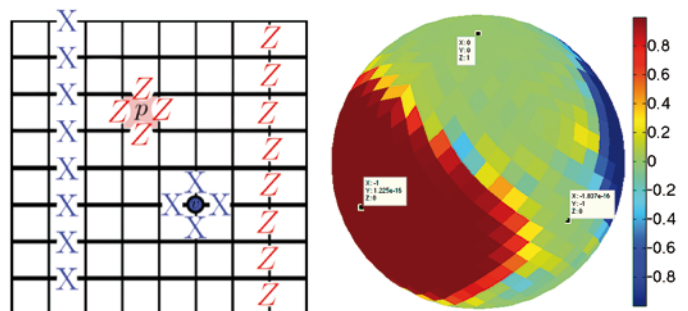

## The entanglement structure of conformal field theories

Tensor network techniques have been successfully applied to model interacting, many-body systems. In some cases, proposed methods have been directly motivated by concepts in quantum computation. The suitability of variational tools such as matrix product states (MPS) can often be understood by studying the entanglement structure of states one wishes to represent. However, the use of these methods has, in some cases, mostly been motivated by their success in numerical experiments, and a rigorous formal justification has been missing. To address this situation, we have asked whether it is possible to represent correlation functions of a conformal field theory by an MPS. Our main result is an algebraic construction of such a state, together with a rigorous error bound: the latter expresses how well the field theory is approximated by the MPS. This gives the first rigorous justification for the use of tensor network methods for modeling, for example, critical one-dimensional spin chains.

## Hypothesis testing and uncertainty relations

We also study fundamental information-theoretic questions arising in quantum mechanics. Milan Mosonyi considered the problem of deciding whether a given black box implements a desired quantum operation or simply replaces the input with a fixed state. Simple decision strategies rely on preparing unentangled product states and measuring the resulting output states. More elaborate schemes may involve creating entangled inputs, but such strategies are clearly more costly to implement. Interestingly, the results obtained reveal that such more elaborate schemes are in fact not necessary, and the optimal discrimination error can be attained by a very simple strategy.

Stefan Huber has taken a similar operational approach based on hypothesis testing to formalize notions of joint measurability. This yields novel Heisenberg-type uncertainty relations as well as error-disturbance tradeoffs.

### Selected Publications

- [1] X. Ni, F. Pastawski, B. Yoshida, and R. König, "Preparing topologically ordered states by Hamiltonian interpolation," *New J. Phys.*, vol. 18, no. 093027, 2016.
- [2] R. König, and V. Scholz, "Matrix product approximations to multipoint functions in two-dimensional conformal field theory," *Phys. Rev. Lett.*, vol. 117, no. 12, 2016.
- [3] T. Cooney, M. Mosonyi, and M. M. Wilde, "Strong converse exponents for a quantum channel discrimination problem and quantum-feedback-assisted communication," *Commun. Math. Phys.*, vol. 344, no. 3, pp. 797–829, 2016.

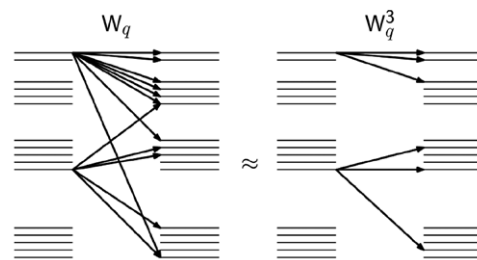

2 | Tensor network techniques can reproduce correlation functions of conformal field theories. This figure illustrates the renormalization procedure yielding a matrix product state: the correlation functions are expressed as a product of field operators. Each of these operators can create arbitrary superposition of energy eigenstates, requiring an infinite amount of entanglement. The renormalized field operators on the right only create a superposition of a limited number of eigenstates, giving a finite-dimensional approximation.

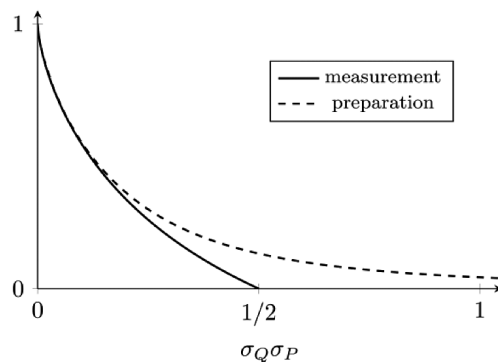

3 | Joint measurability and error-disturbance tradeoffs. New error-disturbance tradeoffs quantitatively express how increasing the precision of measurements (quantified by the combined precision on the horizontal axis) leads to higher disturbance (vertical axis). Two different notions of disturbance related to measurement and preparation are considered.

*Publications by this Focus Group can also be found in the section Publications of this report.*

# Focus Group **Electrochemical Interfaces in Batteries**

Dr. Peter Lamp (BMW Group) | Rudolf Diesel Industry Fellow  
Roland Jung (TUM) | Doctoral Candidate

## Scientific Reports



Peter Lamp

### © Host

[Prof. Hubert A. Gasteiger](#)

Technical  
Electrochemistry,  
TUM

Nowadays, one of the greatest – and most fascinating – technological challenges facing us is the realization of effective electromobility. The development and understanding of novel materials and innovative battery systems is essential for the large-scale commercialization of electric and hybrid-electric vehicles.

This Focus Group aims to develop a detailed understanding of the root causes of battery aging. As most of the degradation processes occur at the interface between the solid electrodes and the liquid electrolyte, this interface is of special interest to understanding current battery technology – and improve upon it in the future. While the existence and importance of the interface between electrode and electrolyte in lithium ion (Li-ion) batteries is unquestionable, its composition, properties, and the fundamental mechanism behind its formation are still under debate for most of the common Li-ion battery materials. In particular, we analyze the gas evolution occurring in a battery cell due to undesired side reactions between the electrode's active material and the electrolyte elements. Gassing in a cell doesn't just have a detrimental impact on the lifetime and stability of the battery cell – the process is also critical for the safety of Li-Ion batteries. By means of these analyses, we aim to explore the limits and capabilities of various battery materials. Furthermore, we want to investigate strategies for extending these limits, which would yield battery materials with improved lifetime, capacity and energy density.

Under the auspices of the Focus Group collaboration, we organized a three-month research stay at the Massachusetts Institute of Technology (MIT) in Boston in 2016. Hosted by Yang Shao-Horn at MIT, this collaboration allowed for the development of a deeper understanding of battery technologies by combining the available analytical resources and techniques from both universities. Our work with MIT is ongoing, and has proved beneficial to advancing our group's work over the past year.

## 4th Munich Battery Discussions

Continuing a “tradition” that we started in 2013, Rudolf Diesel Industry Fellow, Peter Lamp, together with his team at BMW Group and the TUM-IAS, held the 4th Munich Battery Discussions, which took place from March 14–15, 2016. The focus: “Electrode-Electrolyte Interface (EEI) – from Fundamentals to Cell Manufacturing.” As in previous years, this international conference brought together many renowned and leading scientists in the field of battery research. The conference featured 18 speakers from around the globe who presented insights into their latest work and advances in material and battery cell development. The presentations provided the basis for two very fruitful and information-packed days of discussions on the challenges facing battery research in the area of electromobility. The event was also attended by a host of ambitious students and young scientists working to realize a vision for future battery technologies: Overall, the “Battery Discussions” proved such a success that we were set for the 5th Battery Discussions in March 2017 at the time of publication.



1 | Participants of the Munich Battery Discussions in March 2016:

“Electrode-Electrolyte Interface (EEI) – from Fundamentals to Cell Manufacturing.”

## Focus Group Semiconductor Nanowires

Dr. Heike Riel (IBM Research - Zurich) | Rudolf Diesel Industry Fellow  
Bernhard Loitsch (TUM) | Doctoral Candidate

### Scientific Reports



Heike Riel

#### © Hosts

[Dr. Gregor Koblmüller](#)  
Semiconductor Nano-  
structures and Quantum  
Systems, TUM  
[Prof. Alexander W.  
Holleitner](#) Nanoscale  
Optoelectronics, TUM

### Novel nanowire heterostructures for optical and electrical devices

Nanowires (NW) present a new paradigm in realizing advanced semiconductor heterostructures and devices due to their unique, one-dimensional (1-D) architecture. As such, they can be integrated in direct monolithic fashion on versatile platforms, allowing the realization of strongly downsized nanoscale device technologies with the highest possible integration density and improved performance.

Continuing efforts from the previous year, the aim for the Focus Group Semiconductor Nanowires in 2016 was the further advancement of the fundamental understanding and performance of NW-based electronic, thermoelectric and optical devices using sophisticated NW heterostructures on the technologically relevant silicon (Si) platform.

We are conducting our research under the auspices of a joint research program between the Walter Schottky Institute (TUM WSI) at TUM and the IBM Research Laboratory, with support from Heike Riel's TUM-IAS Rudolf Diesel Industry Fellowship. The program interacts closely with the Focus Group Nanophotonics and Quantum Optics, which is working on related research. We are also collaborating with several ongoing projects in the area of NW electronics and lasers, which are being funded by the TUM International Graduate School of Science and Engineering (IGSSE) on several. Here, the role of the team at TUM WSI is to develop novel growth concepts for high-performance, III-V compound semiconductor NW materials on Si, and employ spatially and time-resolved spectroscopy methods for the investigation of fundamental charge carrier dynamics. Complementary studies of charge carrier transport are also being performed at the IBM Research Laboratory, with the goal of integrating NW heterostructures with optimized transport features into advanced electronic and thermoelectric device concepts.

A central focus of our research over the past year was, in particular, the development of NW heterostructures with electronically strongly confined charge carriers in order to realize 2-D-, 1-D- and 0-D-like III-V NW systems for optoelectronic switches [1], photonic applications [2,3], ballistic transistor technologies and high-performance thermoelectric devices [4]. In this respect, the associated doctoral candidate at TUM WSI, Bernhard Loitsch, made remarkable progress in developing ultrathin III-V NWs on Si with tunable 2-D, 1-D and 0-D (quantum-dot)-like characteristics. Using ultrafast optical switches, we demonstrated how the nature and speed of photoelectric excitations depend on dimensionality of the internal electronic system when probing the confined propagation of photogenerated charge carriers [1]. Interestingly, we also found that these systems can host new types of optically highly efficient quantum dots using intentional crystal defects [2] that are capable of acting as single photon emitters (figure 1). Alongside this research, it was also recognized that the formation of 1-D-like ultrathin NW heterostructures is complicated by undesired alloy fluctuations, which may impact the performance of optoelectronic devices, for example, NW lasers [3], and which can be effectively suppressed by tuning growth conditions [5]. The progress gained by this important fundamental understanding of size-, disorder-, and defect-mediated confinement of charge carriers in III-V NWs has been internationally recognized by the prestigious Young Author Best Paper Award, which was bestowed upon Bernhard Loitsch at the Compound Semiconductor Week (CSW) 2016 event in Toyama, Japan.



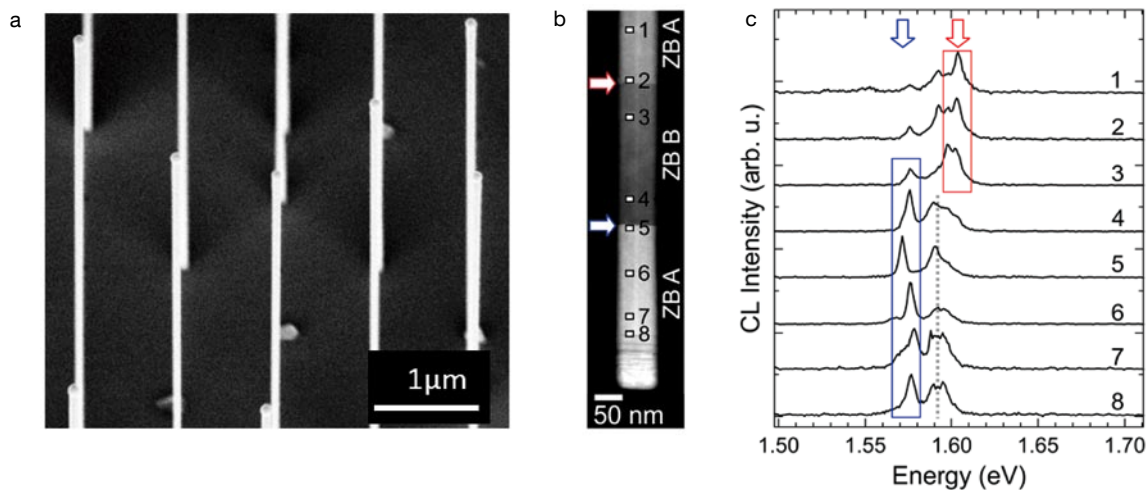

1 | (a) Site-selective GaAs nanowires on Si. (b) Illustration of a single ultrathin GaAs NW core overgrown by AlGaAs shell structure as revealed by STEM imaging. (c) Concurrent cathodoluminescence spectroscopy in STEM showing that individual twin defects act as new sources of quantum dots with single photon emission properties [2].

On the basis of such confined III–V NWs, we also developed a characterization platform for assessing the thermoelectric properties in ultrathin NWs. This was performed in a bachelor thesis by Vanessa Schaller, with the TUM WSI, together with Bernhard Loitsch using thin GaAs NWs. In the latter part of 2016, Vanessa Schaller continued work on her master's thesis at IBM to perform more refined transport and electrothermal characterization on similar NWs. In her work, she investigated the temperature dependence of ballistic transport behavior and related thermoelectric properties using sub-20 nm thin InAs NWs. These investigations revealed the existence of ballistic transport at low-temperature indicative of 1-D-quantization, which is promising for new generations of nanoscale transistors with negligible resistive voltage drop. Simultaneously, these NWs also exhibit drastically enhanced thermoelectric power factors with greater than 100 percent efficiency increases as compared to bulk material [4]. The successful transfer of training and knowledge between WSI and IBM during this project was further awarded by the renowned International IBM Ph.D. Fellowship Award to Bernhard Loitsch in 2016.

In late 2016, all the students and Principal Investigators involved in the program presented their latest work at the TUM-IAS Symposium “Experimental Semiconductor Physics” in honor of Gerhard Abstreiter's 70th Birthday on November 28, 2016.

### Selected Publications

- [1] A. W. Holleitner, “Ultrafast optoelectronics in nanowire-based circuits,” in IEEE Photon Soc. Summ. Top Meet. Series, 2016, pp. 41.
- [2] B. Loitsch, M. Müller, J. Winnerl, P. Veit, D. Rudolph, G. Abstreiter, J. J. Finley, F. Bertram, J. Christen, and G. Koblmüller, “Microscopic nature of crystal phase quantum dots in ultrathin GaAs nanowires by nanoscale luminescence characterization,” *New J. Phys.*, vol. 18, pp. 063009, 2016.
- [3] T. Stettner, P. Zimmermann, B. Loitsch, M. Döblinger, A. Regler, B. Mayer, J. Winnerl, S. Matich, H. Riedl, M. Kaniber, G. Abstreiter, G. Koblmüller, and J. J. Finley, “Coaxial GaAs-AlGaAs core-multishell nanowire lasers with epitaxial gain control,” *Appl. Phys. Lett.*, vol. 108, pp. 011108, 2016.
- [4] S. Karg, V. Schaller, A. Gaul, K. Moselund, H. Schmid, B. Gotsmann, J. Gooth, and H. Riel, “Ballistic transport and high thermopower in one-dimensional InAs nanowires,” in *Solid State Dev. Res. Conf. (ESSDERC)*, Lausanne, Switzerland, 2016.
- [5] B. Loitsch, N. Jeon, M. Döblinger, J. Winnerl, E. Parzinger, S. Matich, U. Wurstbauer, H. Riedl, G. Abstreiter, J. J. Finley, L. J. Lauhon, and G. Koblmüller, “Suppression of alloy fluctuations in GaAs-AlGaAs core-shell nanowires,” *Appl. Phys. Lett.*, vol. 109, pp. 093105, 2016.

*Publications by this Focus Group can also be found in the section Publications of this report.*

# Focus Group Nanophotonics and Quantum Optics

Prof. Jelena Vuckovic (Stanford University) | Hans Fischer Senior Fellow  
Armin Regler (TUM) | Doctoral Candidate

## Scientific Reports



Jelena Vuckovic

### © Host

Prof. Jonathan Finley  
Semiconductor  
Quantum Nanosystems,  
TUM

## Splicing, splitting and detecting quantum light using nanostructured materials

For many applications ranging from medicine and environmental sensing to imaging and emergent quantum technologies, it is crucial to develop novel optical sources at well-defined frequencies. This quest is particularly relevant for light-emitting devices in the green and mid-infrared regions of the electromagnetic (EM) spectrum, where efficient light-emitting materials simply do not exist. An attractive alternative approach are non-linear optical phenomena, whereby an efficient optical source is built at a practically accessible frequency and subsequently the output is frequency converted to the actual target wavelength. Here, green laser pointers are the most commonly encountered devices in which pairs of infrared photons at 1064nm are spliced together to form green light at 532 nm. Compound III–V semiconductors are highly non-linear optical materials; they can be used e.g. for sum-frequency generation where two input fields, with frequencies  $\omega_1$  and  $\omega_2$ , are mixed to produce a third output wave at a frequency  $\omega_{\text{SFG}} = \omega_1 + \omega_2$ , or difference frequency generation where infrared photons are combined to produce an output wave at  $\omega_{\text{DFG}} = \omega_1 - \omega_2$ . However, in a macroscopic optical medium, the three EM-waves having different frequencies ( $\omega_1$ ,  $\omega_2$  and  $\omega_{\text{D/SFG}}$ ) and, thus, different refractive indices, continually run in and out-of phase with each other, limiting the overall efficiency of the non-linear conversion process. As a result, several tricks have to be applied, including the use of wavelength-scale nano-resonators to recirculate light many times through the medium, and precisely match the phase of the input and output fields.

Our Focus Group is exploring the use of artificial nanostructures to generate quantum light produced in III–V semiconductor devices (figure 1a). We are also testing these nanostructures for their inherent efficiency of nonlinear optical processes. The nanostructures are fabricated by electron beam lithography at predefined positions on the substrate, followed by subsequent resist processing and evaporation procedures [1]. These plasmonic nanocavities exhibit small mode volumes on the order of  $5 \times 5 \times 5 \text{ nm}^3$ , which relaxes the phase-matching conditions and allows for good, nonlinear optical conversion when sufficient mode-overlap between the interacting electro-magnetic fields is supported. Our most recent results have shown that bowtie nanoantennas can produce a second-order, nonlinear-optical signal, known as two-photon photoluminescence (TPPL). TPPL is highly dependent on the antenna feedgap-size ( $g$ ) between the two adjacent nanotriangles composing the bowtie, as a reduced gap-size increases the field amplification of the second-order process with an expected net dependence of  $g^{-6}$ . Moreover, this process shows a very high degree of polarization of over 99.9 percent (figure 1b), since only the coupled mode of the bowtie antenna exhibits the strong field-amplification to effectively generate nonlinear optical processes (figure 1c) [2].

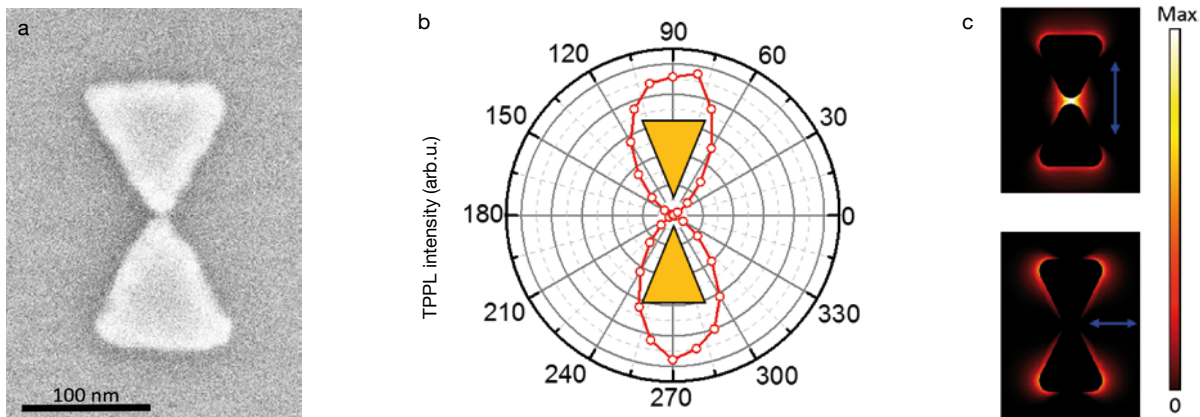

1 | (a) SEM image of a bowtie nanoantenna, which forms a plasmonic nanocavity that allows focusing light to the nanoscale. (b) Dependence of the non-linear TPPL emission on the exciting polarization. The strong degree of polarization results from strong field-amplification within the feedgap region to enhance the nonlinear optical process. (c) Color-maps depicting the mode profiles for along (top) and across (bottom) to the bowtie axis polarized fields (blue arrows). The top mode shows that the high intensity region is in between the two triangles, as the orthogonal mode is located towards the outer boundaries with less local intensity.

In related work, the Focus Group is exploring the coupling of bowtie nanoantennas to photons originating from InGaAs quantum dots (QD). We demonstrated in recent publications that a resonant bowtie nanoantenna can increase the fraction of QD emission into the upper hemisphere from the substrate that can be detected with microscope objective by  $2.4\times$  in case of a QD antenna separation bigger the near-field interaction [3]. In another publication, we demonstrated that reducing the distance to enable near-field interaction (10 nm) leads to Purcell-enhanced emission from near-to-surface QDs, which show a pronounced polarization dependence and reduced lifetimes correlated to the bowtie nanoantennas [4]. By integrating nonlinear optical converters and cavity coupled single photon sources, our group aims to build a new generation of on chip quantum emitters with novel unconventional emission properties.

#### Selected Publications

- [1] M. Kaniber, K. Schraml, A. Regler, J. Bartl, G. Glashagen, F. Flassig, J. Wierzbowski and J. Finley, "Surface plasmon resonance spectroscopy of single bowtie nano-antennas using a differential reflectivity method," *Sci. Rep.*, vol. 6, no. 23203, 2016.
- [2] K. Schraml, A. Regler, J. Bartl, G. Glashagen, J. Wierzbowski, J. Finley, and M. Kaniber, "Metamorphic plasmonic nano-antennas for self-enhanced nonlinear light generation," *OPTICA*, vol. 3, no. 12, pp. 1453–1459, 2016.
- [3] A. Regler, K. Schraml, A. Lyamkina, M. Spiegl, K. Müller, J. Vuckovic, J. Finley, and M. Kaniber, "Emission redistribution from a quantum dot-bowtie nanoantenna," *J. Nanophoton.*, vol. 10, no. 3, pp. 033509, 2016.
- [4] A. Lyamkina, K. Schraml, A. Regler, M. Schalk, A. Bakarov, A. Toropov, S. Moshenko, and M. Kaniber, "Monolithically integrated single quantum dots coupled to bowtie nano-antennas," *Opt. Express.*, vol. 24, no. 26, 2016.

*Publications by this Focus Group can also be found in the section Publications of this report.*

# Focus Group Metal-Organic Superlattices of Quantum Magnets

Prof. Harald Brune (EPFL) | Hans Fischer Senior Fellow  
Raphael Hellwig, Georg Michelitsch (TUM) | Doctoral Candidates

## Scientific Reports



Harald Brune

### © Hosts

Prof. Johannes Barth

Molecular Nanoscience and Chemical Physics of Interfaces, TUM

Prof. Karsten Reuter

Theoretical Chemistry, TUM

## Superlattices of quantum magnets

This Focus Group concentrates on the bottom-up fabrication of well-ordered superlattices of single-atom quantum magnets. These lattices have the capability of increasing magnetic information storage to its ultimate limit. Moreover, each individual single-atom magnet is considered as a candidate for a quantum bit – these bits form the active element of a quantum computer. A breakthrough was achieved in identifying with Ho atoms on MgO(100) thin films a system in which the individual atoms retain their magnetization for hours at low temperatures [4]. Further, reading and writing of these atoms was demonstrated [1], ordered arrays of single atom magnets were created [5], and finally, electron spin resonance over single atoms was achieved with the scanning tunneling microscope [2]. This gives access to the coherence time of magnetic quantum states that is the key characteristic for quantum operations on single magnetic atoms.

## Metal-organic networks with lanthanides

The lanthanides Tb, Dy, and Ho were identified as single atom magnets when adsorbed individually onto certain surfaces. Therefore we investigated the possibility to self-assemble metal-organic superlattices containing these elements. Superlattices with remarkable thermal robustness were achieved with Gd and terphenyl dicarboxylic acid (TDA) on Cu(111) [3]. Figure 1 shows that terephthalate acid (TPA) forms well-ordered superlattices with Ho atoms on a Ag(100) surface. The first step to the self-assembly is the deprotonation of the end groups accomplished at 450 K substrate temperature. Figure 1a shows the resulting c (10×4) structure. After deposition of Ho atoms at 300 K onto this surface, and subsequent annealing to 450 K, a square ( $\sqrt{29} \times \sqrt{29}$ ) lattice with one Ho atom and four TPA molecules per unit cell forms (figures 1b and 1c). The Ho(TPA)<sub>4</sub> compounds are formed through strong bonding between one Ho atom (yellow circle) and four carboxylate groups (blue lobes), while opposite functional groups bind with their counterparts of the adjacent unit cells, creating the regular network [6]. The Ho atoms have a 1.56 nm mutual distance and are coordinated to eight oxygen atoms. To first order, the symmetry of the adsorption site is C<sub>8v</sub> favoring stable magnetic states as it approaches the ideal C<sub>∞</sub> situation [5].

1 | (a) Structure of terephthalate acid (TPA) (top) and STM image of periodic structure formed by deprotonated TPA on Ag(100) (bottom). (b) Metal-organic Ho(TPA)<sub>4</sub> superlattice on Ag(100). (c) Zoom with overlaid adsorption model.

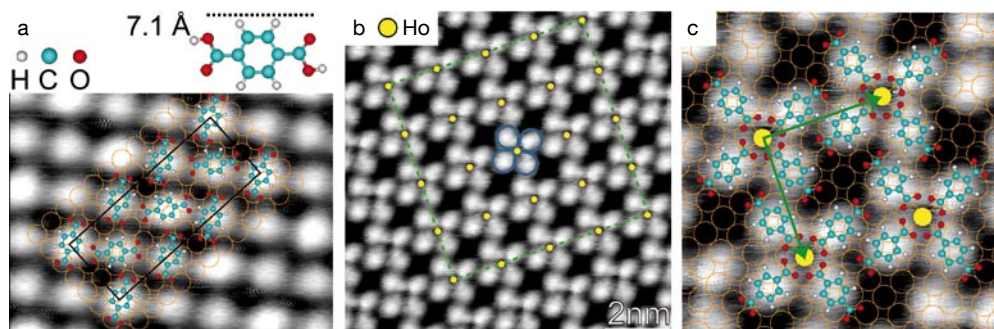

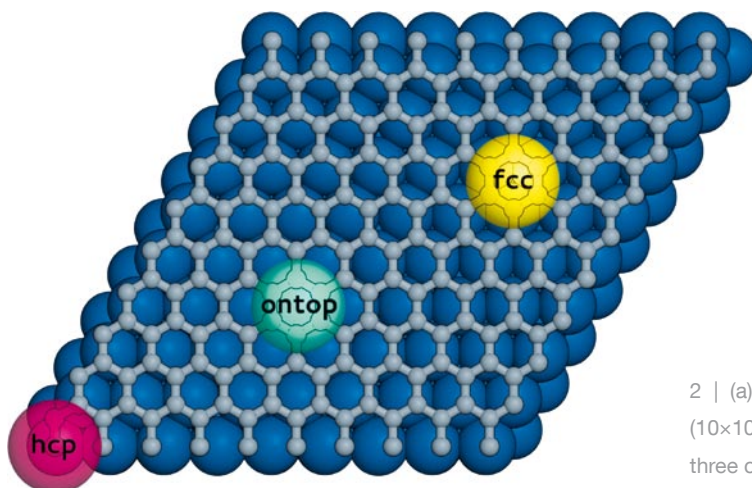

2 | (a) Commensurate structure of corrugated (10×10) graphene on (9×9) Ir(111) showing the three considered 6-fold adsorption sites.

## Predictive-quality simulations of a regular lattice of Dy atoms on graphene

Graphene forms a moiré pattern on Ir(111), where roughly 10 graphene unit cells are adsorbed onto 9 Ir atoms. This creates stacking areas where the  $C_6$  rings are above an hcp, an fcc-site, or an Ir atom (figure 2 a). Dy atoms adsorbed at 40 K diffuse and reach the on-top site. For Dy coverages around one atom per moiré unit cell this leads to a regular superlattice of atoms, in which each individual atom is a potential magnetic bit [5]. First-principle calculations of that system are challenged by the large size imposed by the buckled graphene layer on an extended metal substrate together with the necessity to sufficiently localize the electrons in the  $4f$  states of the Dy adsorbates. In general, this requires at least treatments on the hybrid functional density-functional theory (DFT) level. While this level is presently largely intractable for corresponding system sizes, the accuracy and appropriateness of hybrid functionals for the description of metallic systems is still an open issue. In this situation, we have chosen to concentrate on the subsystem composed of a free-standing (flat and buckled) graphene layer and the Dy adsorbates. The buckling is the one inferred from DFT calculations of graphene on Ir(111).

Hybrid functionals admix a certain degree of exact exchange, the quantitative amount of which is not fully established and likely system dependent. To address this, we conduct additional dispersion-corrected semi-local DFT calculations, which are augmented with a Hubbard-type model Hamiltonian for charge localization (DFT+ $U$ ). This approach allows us to smoothly vary the degree of localization through a  $U$  parameter, and thereby to systematically assess its effect on hybridization and adsorbate bonding. These calculations reveal the relative adsorption energies at the three sites to be very close, and their relative ordering to sensitively depend on the degree of charge localization. A correct assignment of the adsorption site is thus critically dependent on the correct description of the electronic structure in terms of the alignment of the  $4f$  atomic states, which in turn is directly influenced by the choice of the parameter  $U$  in the DFT+ $U$  formalism (or the admixture of exact exchange in hybrid DFT). The Focus Group is therefore currently concentrating on a systematic determination of the  $U$  parameter through dedicated, high-level calculations performed for smaller model systems, as well as the possibility to reliably obtain  $U$  through spectroscopic measurements.

Scientific Reports  
Metal-Organic Superlattices of Quantum Magnets

2 | (b) Adsorption energy curves and spin magnetic moment as a function of adsorption height of Dy on corrugated (10×10) graphene.

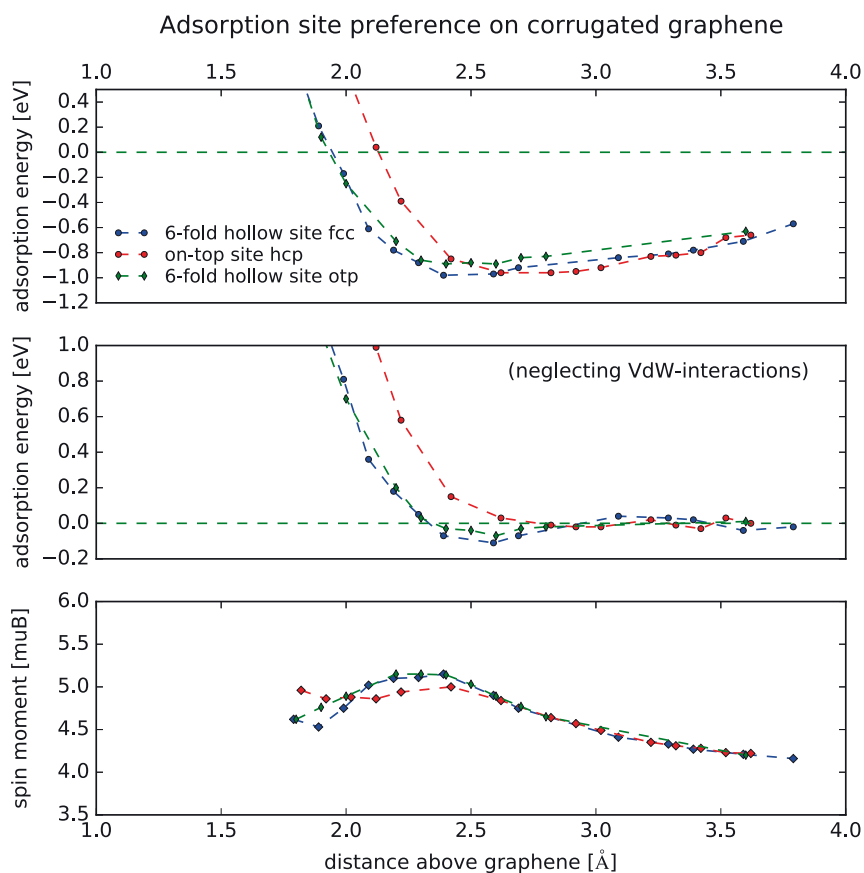

### References

- [1] F. D. Natterer, K. Yang, W. Paul, P. Willke, T. Choi, T. Greber, A. J. Heinrich, and C. P. Lutz, "Reading and writing single-atom magnets," *Nature*, vol. 543, no. 7644, pp. 226-228, 2017.
- [2] S. Baumann, W. Paul, T. Choi, C.P. Lutz, A. Ardavan, and A.J. Heinrich, "Electron paramagnetic resonance of individual atoms on a surface," *Science*, vol. 350, no. 6259, pp. 417-420, 2015.
- [3] J. I. Urgel, B. Cirera, Y. Wang, W. Auwärter, R. Otero, J. M. Gallego, M. Alcam, S. Klyatskaya, M. Ruben, F. Martin, et al., "Surface-supported robust 2D lanthanide-carboxylate coordination networks," *Small*, vol. 11, no. 47, pp. 6358-6364, 2015.

### Selected Publications

- [4] F. Donati, S. Rusponi, S. Stepanow, C. Wäckerlin, A. Singha, L. Persichetti, R. Baltic, K. Diller, F. Patthey, E. Fernandes, H. Brune, et al., "Magnetic remanence in single atoms," *Science*, vol. 352, no. 6283, pp. 318-321, 2016.
- [5] R. Baltic, M. Pivetta, F. Donati, C. Wäckerlin, A. Singha, J. Dreiser, S. Rusponi, and H. Brune, "Superlattice of single atom magnets on graphene," *Nano Lett.*, vol. 16, no. 12, pp. 7610-7615, 2016.
- [6] R. Hellwig, T. Paintner, Z. Chen, M. Ruben, A. P. Seitsonen, F. Klappenberger, H. Brune, and J. V. Barth, "Epitaxy-induced assembly and enantiomeric switching of an on-surface formed dinuclear organocobalt complex," *ACS Nano*, vol. 11, pp. 1347-1359, 2017, accepted in 2016.

*Publications by this Focus Group can also be found in the section Publications of this report.*







## Publications

## Publications

### Advanced Computation and Modeling

Advanced Stability Analysis	186
Complex Systems Modeling and Computation	186
Computational Mechanics: Geometry and Numerical Simulation	186
High-Performance Computing (HPC)	187
Uncertainty Quantification and Predictive Modeling	188

### Bio-Engineering and Imaging

Human-Machine Collaborative Systems	188
Image-based Biomedical Modeling	188
Microfluidic Design Automation	189
Neuroimaging	190
Optimal Control and Medical Imaging	190
Phase-Contrast Computed Tomography	191

### Communication and Information

Exploiting Antenna Arrays for Next-Generation Wireless Communications Systems	192
Information, Interaction and Mechanism Design	192

### Control Theory, Systems Engineering and Robotics

Automated Controller Synthesis	193
Control and Robotics	193
Networked Cyber-Physical Systems	194
Safe Adaptive Dependable Aerospace Systems (SADAS)	194

### Environmental and Earth Sciences

Climate Flows	195
Environmental Sensing and Modeling	195
Global Change	195
Modeling Spatial Mobility	196
High-Resolution Gravity Modeling	198

## Fundamental Natural and Life Sciences

Fundamental Physics	198
Biochemistry	198
Biomolecular Design	199
Cellular Protein Biochemistry	199
Chemical Catalysis, Photo-catalysis and Electro-catalysis	199
Functional Metagenomics	200
Integrative Structural Biology	200
Physics with Effective Field Theories	200
Population Epigenetics and Epigenomics	201
Protein Misfolding and Amyloid Diseases	201
Sterile Neutrino and Dark Matter	201
Structural Membrane Biochemistry	202
Supramolecular Chemistry	202
Synthetic Biochemistry	202

## Gender and Diversity in Science and Engineering

Biomedical Humanities	202
Gender Stereotypes in Organizations	202
Preventive Pediatrics	202

## Medical Natural Sciences

Brain Temperature Control of Metabolic Diseases	203
Clinical Cell Processing and Purification	203
MicroRNAs Regulating Diabetes and Obesity	203
Proteases in the Brain	203
Proteomics	204
Viral Hepatitis	204

## Surface, Interface, Nano- and Quantum Science

Collective Quantum Dynamics	206
Functional Interfaces	206
Metal-Organic Superlattices of Quantum Magnets	206
Nanophotonics and Quantum Optics	207
Semiconductor Nanowires	207
Theory of Complex Quantum Systems	207

## Advanced Stability Analysis

- T. Hummel, F. M. Berger, B. Schuermans, and T. Sattelmayer, "Theory and modeling of non-degenerate transversal thermoacoustic limit cycle oscillations," in Proceedings of the 2016 International Symposium on Thermoacoustic Instabilities in Gas Turbines and Rocket Engines: Industry meets Academia, Munich, Germany.
- F. Berger, T. Hummel, M. Hertweck, J. Kaufmann, B. Schuermans, and T. Sattelmayer, "High-frequency thermoacoustic modulation mechanisms in swirl-stabilized gas turbine combustors - Part One: experimental investigation of local flame response," *J. Eng. Gas Turbines Power*, vol. 149, no. 7, pp. 071501–071510, 2016.
- T. Hummel, K. Hammer, P. Romero, B. Schuermans, and T. Sattelmayer, "Low-order modeling of nonlinear high-frequency transversal thermoacoustic oscillations in gas turbine combustors," in ASME Turbo Expo, Seoul, South Korea, 2016.
- M. Hertweck, F. M. Berger, T. Hummel, and T. Sattelmayer, "Pulsation Amplitude Dependent Flame Dynamics of High Frequency Thermoacoustic Oscillations in Lean-Premixed Gas Turbine Combustors," *Int. J. Spray Combust. Dynam.*, 2016.

## Complex Systems Modeling and Computation

- F. P. Kemeth, S. W. Haugland, L. Schmidt, I. G. Kevrekidis, and K. Krischer, "A classification scheme for chimera states," *Chaos*, vol. 26, p. 094815, 2016.
- O. Junge and I. G. Kevrekidis, "On the sighting of unicorns: a variational approach to computing invariant sets in dynamical systems," *Chaos*, 2017, accepted in 2016.
- M. Choi, T. Bertalan, C. R. Laing, and I. G. Kevrekidis, "Dimension reduction in heterogeneous neural networks: Generalized Polynomial Chaos (gPC) and ANalysis-Of-Variance (ANOVA)," *Eur. Phys. J. Spec. Top.*, vol. 225, no. 6, pp.1165–1180, 2016.
- A. Holiday and I. G. Kevrekidis, "Equation-free analysis of a dynamically evolving multigraph," *Eur. Phys. J. Spec. Top.*, vol. 225, no. 6, pp. 1281–1292, 2016.
- K. Rajendran, A. C. Tsoumanis, C. I. Siettos, C. R. Laing, and I. G. Kevrekidis, "Modeling heterogeneity in neural networks using polynomial chaos," *Int. J. Mult. Comp. Eng.*, vol. 14, no. 3, pp. 291–302, 2016.
- A. Ben-Tal and I. G. Kevrekidis, "Coarse-Graining and simplification of the dynamics seen in bursting neurons," *SIAM J. Appl. Dyn. Syst.*, vol. 15, no. 2, pp.1193–1226, 2016.
- A. A. Kattis, A. Holiday, A.-A. Stoica, and I. G. Kevrekidis, "Modeling epidemics on adaptively evolving networks: A data-mining perspective," *Virulence*, vol.7, no. 2, pp. 153–162, 2016.
- A. Mitsos, J. Najman, and I. G. Kevrekidis, "Optimal deterministic algorithm generation," *J. Global Optimization*, 2017, accepted in 2016.
- E. Chiavazzo, R. R. Coifman, R. Covino, C. W. Gear, A. S. Georgiou, G. Hummer, and I. G. Kevrekidis, "iMapD: intrinsic Map Dynamics exploration for uncharted effective free energy landscapes" *PNAS*, 2017, accepted in 2016.
- O. Yair, R. Talmon, R. R. Coifman, and I. G. Kevrekidis, "No equations, no parameters, no variables: data, and the reconstruction of normal forms by learning informed observation geometries," *PNAS*, 2017, accepted in 2016.

## Computational Mechanics: Geometry and Numerical Simulation

- D. D'Angella, N. Zander, S. Kollmannsberger, F. Frischmann, A. Schröder, E. Rank, and A. Reali, "Multi-level hp-adaptivity and explicit error estimation," *Adv. Model. Simul. Eng. Sci.*, vol. 3, no. 33, 2016.
- F. Auricchio, L. B. Da Veiga, J. Kiendl, C. Lovadina, and A. Reali, "Isogeometric collocation mixed methods for rods," *Discret. Contin. Dyn. S. - Series S*, vol. 9, no. 1, pp. 33–42, 2016.
- F. Auricchio, E. Boatti, A. Reali, and U. Stefanelli, "Gradient structures for the thermomechanics of shape-memory materials," *Comput. Methods Appl. Mech. Eng.*, vol. 299, pp. 440–469, 2016.
- H. Casquero, L. Liu, Y. Zhang, A. Reali, and H. Gomez, "Isogeometric collocation using analysis-suitable T-splines of arbitrary degree," *Comput. Methods Appl. Mech. Eng.*, vol. 301, pp. 164–186, 2016.
- F. Auricchio, A. Lefieux, A. Reali, and A. Veneziani, "A locally anisotropic fluid-structure interaction remeshing strategy for thin structures with application to a hinged rigid leaflet," *Int. J. Numer. Meth. Eng.*, vol. 107, pp. 155–180, 2016.

- S. Morganti, N. Brambilla, A. S. Petronio, A. Reali, F. Bedogni, and F. Auricchio, “Prediction of patient-specific post-operative outcomes of TAVI procedure: The impact of the positioning strategy on valve performance,” *J. Biomech.*, vol. 49, pp. 2513–2519, 2016
- D. Gallo, A. Lefieux, S. Morganti, A. Veneziani, A. Reali, F. Auricchio, M. Conti, and U. Morbiducci, “A patient-specific follow up study of the impact of thoracic endovascular repair (TEVAR) on aortic anatomy and on post-operative hemodynamics,” *Comput. Fluids*, vol. 141, pp. 54–61, 2016.
- M. Conti, C. Long, M. Marconi, R. Berchiolli, Y. Bazilevs, and A. Reali, “Carotid artery hemodynamics before and after stenting: A patient specific CFD study,” *Comput. Fluids*, vol. 141, pp. 62–74, 2016.
- J. Kiendl, M. Ambati, L. De Lorenzis, H. Gomez, and A. Reali, “Phase-field description of brittle fracture in plates and shells,” *Comput. Methods Appl. Mech. Eng.*, vol. 312, pp. 374–394, 2016.
- L. Kudela, N. Zander, S. Kollmannsberger, and E. Rank, “Smart Octrees: Accurately Integrating Discontinuous Functions in 3D,” *Comput. Methods Appl. Mech. Eng.*, vol. 306, pp. 406–26, 2016.
- R. Seidl and E. Rank, “Iterative Time Reversal Based Flaw Identification,” *Comput. Math. Appl.*, vol. 72, no. 4, pp. 879–92, 2016.
- H. Wille, Martin Ruess, E. Rank, and Z. Yosibash, “Uncertainty Quantification for Personalized Analyses of Human Proximal Femurs,” *J. Biomech.*, vol. 49, no. 4, pp. 520–27, 2016.
- N. Zander, T. Bog, M. Eihaddad, F. Frischmann, S. Kollmannsberger, and E. Rank, “The multi-level hp-method for three-dimensional problems: Dynamically changing high-order mesh refinement with arbitrary hanging nodes,” *Comput. Methods Appl. Mech. Eng.*, vol. 310, pp. 252–277, 2016.

### High-Performance Computing (HPC)

- A. Bakhtiari, D. Malhotra, A. Raoofy, M. Mehl, H.-J. Bungartz, and G. Biros, “A parallel arbitrary-order accurate AMR algorithm for the scalar advection-diffusion equation,” in *Proceedings of the International Conference for High Performance Computing, Networking, Storage and Analysis (SC 16)*, Salt Lake City, USA, 2016, no. 44.
- A. Mang, A. Gholami, and G. Biros, “Distributed-memory large deformation diffeomorphic 3D image registration,” in *Proceedings of the International Conference for High Performance Computing, Networking, Storage and Analysis (SC 16)*, Salt Lake City, USA, 2016, no. 72.
- H.-J. Bungartz, F. Lindner, B. Gatzhammer, M. Mehl, K. Scheufele, A. Shukaev, and B. Uekermann, “PreCICE – A fully parallel library for multi-physics surface coupling,” *Comput. Fluids*, vol. 141, pp. 250–258, 2016.
- M. Mehl, B. Uekermann, H. Bijl, D. Blom, B. Gatzhammer, and A. H. van Zuijlen. “Parallel coupling numerics for partitioned fluid-structure interaction simulations,” *Comput. Math. Appl.*, vol. 71, no. 4, pp. 869–891, 2016.
- R. Haelterman, A. Bogaers, B. Uekermann, K. Scheufele, and M. Mehl, “Improving the performance of the partitioned QN-ILS procedure for fluid-structure interaction problems: filtering,” *Comput. Struct.*, vol. 171, pp. 9–17, 2016.
- D. Blom, T. Ertl, O. Fernandes, S. Frey, H. Klimach, V. Krupp, M. Mehl, S. Roller, D. Sternel, B. Uekermann, T. Winter, and A. van Zuijlen, “Partitioned fluid-structure-acoustics interaction on distributed data – numerical results and visualization,” in *Software for Exa-scale Computing – SPPEXA 2013–2015*, H.-J. Bungartz, P. Neumann, and E. Nagel, Eds. Cham: Springer, 2016, pp. 267–291.
- H.-J. Bungartz, F. Lindner, M. Mehl, K. Scheufele, A. Shukaev, and B. Uekermann, “Partitioned fluid-structure-acoustics interaction on distributed data – coupling via preCICE,” in *Software for Exa-scale Computing – SPPEXA 2013–2015*, H.-J. Bungartz, P. Neumann, and E. Nagel, Eds. Cham: Springer, 2016, pp. 239–266.
- D. Blom, F. Lindner, M. Mehl, K. Scheufele, B. Uekermann, and A. van Zuijlen, “A review on fast quasi-Newton and accelerated fixed point iterations for partitioned fluid-structure interaction simulation,” in *Advances in Computational Fluid-Structure Interaction and Flow Simulation*, Y. Bazilevs and K. Takizava, Eds. Cham: Springer, 2016, pp. 257–269.
- A. Atanasov, B. Uekermann, C.A. Pachajoa Mejia, H.-J. Bungartz, and P. Neumann, “Steady-state Anderson accelerated coupling of lattice Boltzmann and Navier-stokes solvers,” *Computation*, vol. 4, no. 4, 2016.
- C. Kowitz, “Applying the sparse grid combination technique in linear gyrokinetics,” Ph.D. dissertation, Department of Informatics, Technical University of Munich, Germany, 2016.

- V. Khakhutskyy, “Sparse grids for big data: exploiting parsimony for large-scale learning,” Ph.D. dissertation, Department of Informatics, Technical University of Munich, Germany, 2016.
- B. Uekermann, “Partitioned fluid-structure interaction on massively parallel systems,” Ph.D. dissertation, Department of Informatics, Technical University of Munich, Germany, 2016.

### Uncertainty Quantification and Predictive Modeling

- M. Schöberl, N. Zabarar, and P. S. Koutsourelakis, “Predictive Coarse-Graining”, *J. Comput. Phys.*, vol. 333, pp. 49–77, 2017, accepted in 2016.

## Bio-Engineering and Imaging

### Human-Machine Collaborative Systems

- C. Rupprecht, C. Lea, F. Tombari, N. Navab, and G. D. Hager, “Sensor substitution for video-based action recognition,” in *Proceedings of the IEEE/RSJ International Conference on Intelligent Robots and Systems (IROS)*, Daejeon, Korea, 2016, pp. 5230-5237.
- R. DiPietro, C. Lea, A. Malpani, N. Ahmidi, S. S. Vedula, G. I. Lee, M. R. Lee, and G. D. Hager, “Recognizing surgical activities with recurrent neural networks,” in *Proceedings of the International Conference on Medical Image Computing and Computer-Assisted Intervention (MICCAI)*, Istanbul, Turkey, 2016, pp. 551-558.

### Image-based Biomedical Modeling

- B. H. Menze, K. Van Leemput, D. Lashkari, T. Riklin-Raviv, P. Gruber, S. Wegener, M. A. Weber, N. Ayache, and P. Golland, “A generative probabilistic model and discriminative extensions for brain lesion – with application to tumor and stroke,” *IEEE Trans. Med. Imag.*, vol. 35, no. 4, pp. 933–946, 2016.
- T. Hershkovich, T. Shalmon, O. Shitrit, N. Halay, B.H. Menze, I. Dolgopyat, I. Kahn, I. Shelef, and T. Riklin-Raviv, “Probabilistic model for 3D interactive segmentation,” *Comput. Vis. Image Underst.*, vol. 151, no. C, pp. 47–60, 2016.
- L. Bothmann, B. H. Menze, A. Menzel, and G. Kauermann, “Automated processing of webcam images for phenological classification,” *PLOS one*, vol. 12, no. 2, 2017, accepted in 2016.
- J. Shen, T. Baum, C. Cordes, B. Ott, T. Skurk, H. Koojman, E. Rummeny, H. Hauer, B. H. Menze, and D. Karapinos, “Automatic organ-specific localization and quantification of fat in abdominal water-fat MRI: application to weight-loss in obesity,” *Eur. J. Radiol.*, vol. 85, no. 9, pp. 1613–1621, 2016.
- O. Jimenez-Del-Toro, H. Muller, M. Krenn, K. Gruenberg, A. A. Taha, M. Winterstein, I. Eggel, A. Foncubierta-Rodriguez, O. Goksel, A. Jakab, G. Kontokotsios, G. Langs, B. Menze, T. Salas Fernandez, R. Schaer, A. Walleyo, M. A. Weber, Y. Dicente Cid, T. Gass, M. Heinrich, F. Jia, F. Kahl, R. Kechichian, D. Mai, A. Spanier, G. Vincent, C. Wang, D. Wyeth, and A. Hanbury, “Cloud-based evaluation of anatomical structure segmentation and landmark detection algorithms: VISCERAL anatomy benchmarks,” *IEEE Trans. Med. Imag.*, vol. 35, no.11, pp. 2459–2475, 2016.
- O. Maier, B. H. Menze, J. von der Gablentz, L. Häni, M. P. Heinrich, M. Liebrand, S. Winzeck, A. Basit, P. Bentley, L. Chen, D. Christiaens, F. Dutil, K. Egger, C. Feng, B. Glocker, M. Götz, T. Haeck, H. L. Halme, M. Havaei, K. M. Iftekharruddin, P. M. Jodoin, K. Kamnitsas, E. Kellner, A. Korvenoja, H. Larochelle, C. Ledig, J. H. Lee, F. Maes, Q. Mahmood, K. H. Maier-Hein, R. McKinley, J. Muschelli, C. Pal, L. Pei, J. R. Rangarajan, S. M. Reza, D. Robben, D. Rueckert, E. Salli, P. Suetens, C. W. Wang, M. Wilms, J. S. Kirschke, U.M. Krämer, T. F. Münte, P. Schramm, R. Wiest, H. Handels, and M. Reyes, “ISLES 2015 - A public evaluation benchmark for ischemic stroke lesion segmentation from multispectral MRI,” *Med. Image Anal.*, vol. 35, pp. 250–269, 2016.
- D. Andreasen, J. Edmund, V. Zografos, B. H. Menze, and K. Van Leemput, “Computed tomography synthesis from magnetic resonance images of the pelvic region by a combination of random classification and regression forests and auto-context features,” *Proc. SPIE: Medical Imaging 2016*, vol. 9784, 2016.
- E. Alberts, M. Rempfler, G. Alber, T. Huber, J. Kirschke, C. Zimmer C, and B. H. Menze, “Uncertainty quantification in brain tumor segmentation using CRFs and random perturbation models,” in *IEEE 13th International Symposium on Biomedical Imaging*, Prague, Czech Republic, 2016.
- C. Ulas, P. Gomez, J. Sperl, and B. H. Menze, “Spatio-temporal MRI reconstruction by enforcing local and global regularity via dynamic total variation and nuclear norm minimization,” in *IEEE 13th International Symposium on Biomedical Imaging*, Prague, Czech Republic, 2016.

- P. Christ, F. Lachner, A. Hösl, B. H. Menze, K. Diepold, and A. Butz, “Human-Drone-Interaction: a case study to investigate the relation between autonomy and user experience,” in *Computer Vision – ECCV 2016 Workshops*, Amsterdam, The Netherlands, 2016, pp. 238–253.
- Y. Nagaraj, B. H. Menze, and M. Friebe, “US/MRI fusion with new optical tracking and marker approach for interventional procedures inside the MRI suite,” *Curr. Dir. Biomed. Eng.*, vol. 2, no. 1, pp. 459–462, 2016.
- U. Sivalingam, M. Wels, M. Rempfler, S. Grosskopf, M. Suehling, and B. H. Menze, “Inner and outer coronary vessel wall segmentation from CCTA using an active contour model with machine learning-based 3D voxel context-aware image force,” *Proc. SPIE: Medical Imaging 2016*, vol. 9784, 2016.
- C. Ulas, P. A. Gomez, F. Kraemer, J. I. Sperl, M. I. Menzel, and B. H. Menze, “Robust reconstruction of accelerated perfusion MRI using local and nonlocal constraints,” in *Proceedings of MICCAI Workshop on Reconstruction and Analysis of Moving Body Organs*, Athens, Greek, 2016.
- M. Rempfler, B. Andres, and B. H. Menze, “The minimum cost connected subgraph problem in medical image analysis,” in *Proceedings of MICCAI Workshop on Reconstruction and Analysis of Moving Body Organs*, Athens, Greek, 2016.
- D. Das, E. Coello, R. F. Schulte, and B. H. Menze, “Spatially adaptive spectral denoising for MR spectroscopic imaging using frequency-phase non-local means,” in *Proceedings of MICCAI Workshop on Reconstruction and Analysis of Moving Body Organs*, Athens, Greek, 2016.
- P. A. Gomez, M. Molina-Romero, C. Ulas, G. Bounincontri, J. Sperl, D. K. Jones, M. I. Menzel, and B. H. Menze, “Simultaneous parameter mapping, modality synthesis, and anatomical labeling of the brain with MR fingerprinting,” in *Proceedings of MICCAI Workshop on Reconstruction and Analysis of Moving Body Organs*, Athens, Greek, 2016.
- P. Christ, M. Elshaer, F. Ettliger, S. Tatavarty, M. Bickel, P. Bilic, M. Rempfler, M. Armbruster, M. Hofmann, M. D’Anastasi, W. Sommer, A. Ahmadi, and B. H. Menze, “Automatic liver and lesion segmentation in CT using cascaded fully convolutional neural networks and 3D conditional random fields,” in *Proceedings of MICCAI Workshop on Reconstruction and Analysis of Moving Body Organs*, Athens, Greek, 2016.

### Microfluidic Design Automation

- T.-M. Tseng, B. Li, M. Li, T.-Y. Ho, and U. Schlichtmann, “Reliability-aware Synthesis with Dynamic Device Mapping and Fluid Routing for Flow-based Microfluidic Biochips,” *IEEE Transactions on Computer-Aided Design of Integrated Circuits and Systems (IEEE TCAD)*, vol. 35, no. 12, pp. 1981–1994, 2016.
- T.-M. Tseng, M. Li, B. Li, T.-Y. Ho, and U. Schlichtmann, “Columba: Co-Layout Synthesis for Continuous-Flow Microfluidic Biochips,” in *Proceedings of the 53rd ACM/EDAC/IEEE Design Automation Conference (DAC)*, Austin, USA, 2016, no. 147, pp. 1–6.
- Q. Wang, Z. Li, O.-S. Kwon, H. Yao, T.-Y. Ho, K. Shin, B. Li, U. Schlichtmann, and Y. Cai, “Control-Fluidic CoDesign for Paper-Based Digital Microfluidic Biochips,” in *Proc. of the IEEE/ACM International Conference on Computer-Aided Design (ICCAD-2016)*, Austin, USA, 2016, pp. 1–8.
- Z. Lee, T.-Y. Ho, and K. Chakrabarty, “Optimization of 3D Digital Microfluidic Biochips for the Multiplexed Polymerase Chain Reaction,” *ACM Transactions on Design Automation of Electronic Systems (ACM TODAES)*, vol. 21, no. 25, 2016.
- T.-Y. Ho, S. Yamashita, A. Banerjee, and S. Roy, “Design of Microfluidic Biochips: Connecting Algorithms and Foundations of Chip Design to Biochemistry and the Life Sciences,” in *Proceedings of IEEE International Conference on VLSI Design (VLSI-2016)*, Kolkata, India, 2016, pp. 59–62.
- Y.-H. Su, T.-Y. Ho, and D. T. Lee, “A Routability-Driven Flow Routing Algorithm for Programmable Microfluidic Devices,” in *Proceedings of IEEE/ACM Asia and South Pacific Design Automation Conference (ASPDAC-2016)*, Macao, China 2016, pp. 605–610.
- Q. Wang, Y. Ru, H. Yao, T.-Y. Ho, and Y. Cai, “Sequence-Pair-Based Placement and Routing for Flow-Based Microfluidic Biochips,” in *Proceedings of IEEE/ACM Asia and South Pacific Design Automation Conference (ASPDAC-2016)*, Macao, China, 2016, pp. 587–592.
- J.-D. Lee, S.-M. Lee, S.-J. Wang, and T.-Y. Ho, “Congestion- and Timing-Driven Droplet Routing for Pin-Constrained Paper-Based Microfluidic Biochips,” in *Proceedings of IEEE/ACM Asia and South Pacific Design Automation Conference (ASPDAC-2016)*, Macao, China, 2016, pp. 593–598.

- J.-D. Lee, S.-M. Lee, S.-J. Wang, and T.-Y. Ho, "Test and Diagnosis of Paper-Based Microfluidic Biochips," in Proceedings of IEEE VLSI Test Symposium (VTS-2016), Las Vegas, USA, 2016, pp. 1–6.
- K. Hu, T.-Y. Ho, and K. Chakrabarty, "Wash Optimization and Analysis for Cross-Contamination Removal under Physical Constraints in Flow-Based Microfluidic Biochips," IEEE Transactions on Computer-Aided Design of Integrated Circuits and Systems (IEEE TCAD), vol. 35, no. 4, pp. 559–572, 2016.
- Z. Li, Y.-J. Lee, T.-Y. Ho, C.-Y. Lee, and K. Chakrabarty, "High-Level Synthesis for Micro-Electrode-Dot-Array Digital Microfluidic Biochips," in Proceedings of ACM/IEEE Design Automation Conference (DAC-2016), Austin, USA, 2016, pp. 1–6.
- Z. Li, Kelvin Y.-T. Lai, P.-H. Yu, K. Chakrabarty, M. Pajic, T.-Y. Ho, and C.-Y. Lee, "Error Recovery in a Micro-Electrode-Dot-Array Digital Microfluidic Biochip," in Proceedings of IEEE/ACM International Conference on Computer-Aided Design (ICCAD-2016), Austin, USA, 2016, pp. 1–8.
- H. Yao, Q. Wang, Y. Shen, T.-Y. Ho, and Y. Cai, "Integrated Functional and Washing Routing Optimization for Cross-Contamination Removal in Digital Microfluidic Biochips," IEEE Transactions on Computer-Aided Design of Integrated Circuits and Systems (IEEE TCAD), vol. 35, no. 8, pp. 1283–1296, 2016.
- Z. Li, Y.-J. Lee, T.-Y. Ho, C.-Y. Lee, and K. Chakrabarty, "Built-In Self-Test for Micro-Electrode-Dot-Array Digital Microfluidic Biochips," in Proceedings of IEEE International Test Conference (ITC-2016), Fort Worth, USA, 2016, pp. 1–8.

### Neuroimaging

- A. M. Leaver, T. K. Turesky, A. Seydell-Greenwald, S. Morgan, H. J. Kim, and J. P. Rauschecker, "Intrinsic network activity in tinnitus investigated using functional MRI," Human Brain Mapping, vol. 37, no. 8, pp. 2717–2735, 2016.
- L. C. Erickson, J. P. Rauschecker, and P. E. Turkeltaub, "Meta-analytic connectivity modeling of the human superior temporal sulcus," Brain Structure and Function, vol. 222, no. 1, pp. 267–285, 2017, accepted in 2016.
- A. M. Leaver and J. P. Rauschecker, "Functional topography of human auditory cortex," J. Neurosci., vol. 36, no. 4, pp. 1416–1428, 2016.
- J. Alho, B. M. Green, P. J. May, M. Sams, H. Tiitinen, J. P. Rauschecker, and I. P. Jääskeläinen, "Early-latency categorical speech sound representations in the left inferior frontal gyrus," Neuroimage, vol. 129, pp. 214–223, 2016.
- V. Riedl, L. Utz, G. Castrillón, T. Grimmer, J. P. Rauschecker, M. Ploner, K. J. Friston, A. Drzezga, and C. Sorg, "Metabolic connectivity mapping reveals effective connectivity in the resting human brain," PNAS, vol. 113, no. 2, pp. 428–433, 2016.
- J. P. Rauschecker, E. S. May, A. Maudoux, and M. Ploner, "Frontostriatal gating of tinnitus and chronic pain," Trends in Cognitive Sciences, vol. 19, no. 10, pp. 567–78, 2016.
- M. Leaver, A. Seydell-Greenwald, and J. P. Rauschecker, "Auditory-limbic interactions in chronic tinnitus: Challenges for neuroimaging research," Hearing Research, vol. 334, pp. 49–57, 2016.

### Optimal Control and Medical Imaging

- L. Van Damme, P. Mardesic, and D. Sugny, "The tennis racket effect in a three dimensional rigid body," Physica D, vol. 338, no. 1, pp. 17–25, 2017, accepted in 2016.
- M. Riahi, J. Salomon, S. J. Glaser, and D. Sugny, "Fully efficient time parallelized optimal quantum control algorithm," Phys. Rev. A, vol. 94, no. 4, p. 043410, 2016.
- P. Babilotte, K. Hamraoui, F. Billard, E. Hertz, B. Lavorel, O. Faucher, and D. Sugny, "Observation of field-free molecular Orientation of a symmetric top molecule by Terahertz pulses at high temperature," Phys. Rev. A, vol. 94, p. 043403, 2016.



## Phase-Contrast Computed Tomography

- F. Pfeiffer et al., “Pre-clinical dark-field CT imaging of small-animal lung disease models,” in Proceedings of the 4th International Meeting on image formation in X-ray CT, Bamberg, Germany, 2016.
- K. Hellbach et al., “Depiction of pneumothoraces in a large animal model using x-ray dark-field radiography,” Proceedings of the Annual Meeting of the Radiological Society of North America, RSNA, Chicago, USA, 2016.
- L. Gromann et al., “A First Feasibility Study on Phantom Samples and In-Vivo Pigs,” Proceedings of the Annual Meeting of the Radiological Society of North America, RSNA, Chicago, USA, 2016.
- S. Allner, T. Koehler, A. Fehringer, L. Birnbacher, M. Willner, F. Pfeiffer, and P. B. Noel, “Bilateral filtering using the full noise covariance matrix applied to x-ray phase-contrast computed tomography,” *Phys. Med. Biol.*, vol. 61, no. 10, pp. 3867–3884, 2016.
- L. Birnbacher et al., “Tilted grating laboratory phase-contrast computed tomography using statistical iterative reconstruction,” in Proceedings of the International Symposium on BioMedical Applications of X-Ray Phase Contrast Imaging, Garmisch, Germany, 2016.
- L. Birnbacher, M. Willner, A. Velroyen, M. Marschner, A. Hipp, J. Meiser, F. Koch, T. Schröter, D. Kunika, J. Mohr, F. Pfeiffer, and J. Herzen, “Experimental realisation of high-sensitivity laboratory X-ray grating-based phase-contrast computed tomography,” *Sci. Rep.*, vol. 6, no. 24022, pp. 1–8, 2016.
- B. Brendel, M. Teuffenbach, P. B. Noël, F. Pfeiffer, and T. Koehler, “Penalized maximum likelihood reconstruction for x-ray differential phase-contrast tomography,” *Med. Phys.*, vol. 43, no. 1, pp. 188–194, 2016.
- M. Donnelley, K. Morgan, and D. W. Parsons, “Direct x-ray measurement of airway surface health in animal models: An update on the state-of-the-art,” *Pediatr. Pulm.*, vol. 51, 2016.
- M. Donnelley, K. Morgan, N. Farrow, K. Siu, and D. Parsons, “Non-invasive airway health measurement using synchrotron x-ray microscopy of high refractive index glass microbeads,” *AIP Conference Proc.*, vol. 1696, no.1, 2016.
- M. Donnelley, M. Awadalla, K. Morgan, N. Farrow, C. Hall, R. Acres, and D. Parsons, “Assessing particle mucociliary transit in excised sheep trachea using the Australian Synchrotron imaging and medical beamline”, *Respirology*, vol. 21, 2016.
- D. Macindoe, M. J. Kitchen, S. C. Irvine, A. Fouras, K. S. Morgan, “Requirements for dynamical differential phase contrast x-ray imaging with a laboratory source,” *Phys. Med. Biol.*, vol. 61, no. 24, pp. 8720–8735, 2016.
- M. Marschner, M. Willner, G. Potdevin, A. Fehringer, P. B. Noël, F. Pfeiffer, and J. Herzen, “Helical X-ray phase-contrast computed tomography without phase stepping,” *Sci. Rep.*, vol. 6, no. 23953, pp. 1–9, 2016.
- K. S. Morgan, T. C. Petersen, M. Donnelley, N. Farrow, D. W. Parsons, and D. M. Paganin, “Capturing and visualizing transient X-ray wavefront topological features by single-grid phase imaging,” *Opt. Express*, vol. 24, no. 21, pp. 24435–24450, 2016.
- R. P. Murrie, D. M. Paganin, A. Fouras, and K. S. Morgan, “Phase contrast x-ray velocimetry of small animal lungs: optimising imaging rates,” *Biomed. Opt. Express*, vol. 7, no. 1, pp. 79–92, 2016.
- T. C. Petersen, A. I. Bishop, S. A. Eastwood, D. M. Paganin, K. S. Morgan, and M. J. Morgan, “Singularimetry of local phase gradients using vortex lattices and in-line holography,” *Opt. Express*, vol. 24, no. 3, pp. 2259–2272, 2016.
- K. Scherer, L. Birnbacher, K. Willer, M. Chabior, J. Herzen, and F. Pfeiffer, “Correspondence: quantitative evaluation of X-ray dark-field images for microcalcification analysis in mammography,” *Nat. Com.*, vol. 7, no. 10863, 2016.
- C. S. Stahr, C. R. Samarage, M. Donnelley, N. Farrow, K. S. Morgan, G. Zosky, R. C. Boucher, K. K. W. Siu, M. A. Mall, D. W. Parsons, S. Dubsy, and A. Fouras, “Quantification of heterogeneity in lung disease with image-based pulmonary function testing,” *Sci. Rep.*, vol. 6, no. 29438, 2016.
- M. Teuffenbach et al., “Iterative reconstruction of grating-based {PCCT} without phase-stepping,” in Proceedings of the 4th International Meeting on image formation in X-ray CT, Bamberg, Germany, 2016.
- A. Yaroshenko, T. Pritzke, M. Koschlig, N. Kamgari, K. Willer, L. Gromann, S. Auweter, K. Hellbach, M. Reiser, O. Eickelberg, F. Pfeiffer, and A. Hilgendorff, “Visualization of neonatal lung injury associated with mechanical ventilation using x-ray dark-field radiography,” *Sci. Rep.*, vol. 6, no. 24269, pp. 1–8, 2016.

## Exploiting Antenna Arrays for Next-Generation Wireless Communications Systems

- K. Saxena, I. Fijalkow, and A. Swindlehurst, "On one-bit quantized ZF precoding for the multiuser massive MIMO downlink," in 2016 IEEE Sensor Array and Multichannel Signal Processing Workshop (SAM), Rio de Janeiro, Brasil.
- Y. Li, C. Tao, L. Liu, G. Seco-Granados, and A. Swindlehurst, "Channel estimation and uplink achievable rates in one-bit massive MIMO systems," in 2016 IEEE Sensor Array and Multichannel Signal Processing Workshop (SAM), Rio de Janeiro, Brasil.
- L. You, X. Gao, A. Swindlehurst, and W. Zhong, "Channel Acquisition for Massive MIMO-OFDM With Adjustable Phase Shift Pilots," *IEEE Transactions on Signal Processing*, vol. 64, no. 6, pp. 1461–1476, 2016.
- F. Steiner, A. Mezghani, A. Swindlehurst, J. A. Nossek and W. Utschick, "Turbo-Like Joint Data-and-Channel Estimation in Quantized Massive MIMO Systems," in 20th International ITG Workshop on Smart Antennas (WSA), Munich, Germany, 2016.
- O. B. Usman, H. Jedda, A. Mezghani, and J. A. Nossek, "MMSE precoder for massive MIMO using 1-bit quantization," in 2016 IEEE International Conference on Acoustics, Speech and Signal Processing (ICASSP), Shanghai, China, pp. 3381–3385.
- H. Jedda, J. A. Nossek, and A. Mezghani, "Minimum BER precoding in 1-Bit massive MIMO systems," in 2016 IEEE Sensor Array and Multichannel Signal Processing Workshop (SAM), Rio de Janeiro, Brasil.
- W. Idler, F. Buchali, L. Schmalen, E. Lach, R.-P. Braun, G. Böcherer, P. Schulte, and F. Steiner, "Field demonstration of 1Tbit/s super-channel network using probabilistically shaped constellations," in European Conference on Optical Communication (ECOC), Düsseldorf, Germany, 2016, paper M.1.D.2.

## Information, Interaction and Mechanism Design

- F. Brandl, F. Brandt, and H. G. Seedig, "Consistent probabilistic social choice," *Econometrica*, vol. 84, no. 5, pp. 1839–1880, 2016.
- F. Brandl, F. Brandt, and W. Suksompong, "The impossibility of extending random dictatorship to weak preferences," *Econ. Lett.*, vol. 141, pp. 44–47, 2016.
- F. Brandl, F. Brandt, and C. Geist, "Proving the incompatibility of efficiency and strategyproofness via SMT solving," in Proceedings of the 6th International Workshop on Computational Social Choice (COMSOC), Toulouse, France, 2016.
- F. Brandl, F. Brandt, and C. Geist, "Proving the incompatibility of efficiency and strategyproofness via SMT solving," in Proceedings of the 25th International Joint Conference on Artificial Intelligence (IJCAI), New York City, USA, 2016, pp. 116–122.
- D. Bergemann and S. Morris, "First price auctions with general information structures: implications for bidding and revenue," *Econometrica*, vol. 85, no. 1, pp. 107–143, 2016.
- D. Bergemann and S. Morris, "Information design, Bayesian persuasion, and Bayes correlated equilibrium," *Am. Econ. Rev. Papers and Proc.*, vol. 106, pp. 586–591, 2016.
- D. Bergemann and S. Morris, "Bayes correlated equilibrium and the comparison of information structures in games," *Theor. Econ.*, vol. 11, no. 2, pp. 487–522, 2016.
- S. Fadaei and M. Bichler, "Generalized assignment problem: Truthful mechanism design without money," *Oper. Res. Lett.*, vol. 45, no. 1, pp. 72–76, 2016.
- F. Diebold and M. Bichler, "Matching with indifferences: A comparison of algorithms in the context of course allocation," *Eur. J. Oper. Res.*, vol. 260, no. 1, pp. 268–282, 2016.
- M. Bichler and J. Goeree, "Frontiers in spectrum auction design," *Int. J. Ind. Organ.*, vol. 50, pp. 372–391, 2016.
- M. Bichler, Z. Hao, and G. Adomavicius, "Coalition-based pricing in ascending combinatorial auctions," *Inform. Syst. Res.*, 2017, accepted in 2016.
- K. Guler, M. Bichler, and J. Petrakis, "Ascending combinatorial auctions with risk averse bidders," *INFORMS Group Decision and Negotiation*, vol. 25, no. 3, pp. 609–639, 2016.

## Automated Controller Synthesis

- D. Roy, L. Zhang, W. Chang, D. Goswami, and S. Chakraborty, “Multi-objective co-optimization of FlexRay-based distributed control systems,” in 22nd IEEE Real-time and embedded technology and applications symposium, RTAS, Vienna, Austria, 2016, pp. 279–290.
- J. Esparza, D. Kuperberg, A. Muscholl, and I. Walukiewicz, “Soundness in negotiations,” in 27th International Conference on Concurrency Theory, Québec, Canada, 2016, pp. 1–13.
- F. Baschenis, O. Gauwin, A. Muscholl, and G. Puppis: “Minimizing resources of sweeping and streaming string transducers,” in Proceedings of the 43rd International Colloquium on Automata, Languages, and Programming (ICALP), 2016, pp.1–14.
- D. Kuperberg, J. Brunel, and D. Chemouil, “On finite domains in first-order linear temporal logic,” in Proceedings of the 14th International Symposium on Automated Technology for Verification and Analysis (ATVA), 2016, pp. 211–226.
- N. Macedo, J. Brunel, D. Chemouil, A. Cunha, and D. Kuperberg, “Lightweight specification and analysis of dynamic systems with rich configurations,” in Proceedings of the 24th ACM SIGSOFT International Symposium on Foundations of Software Engineering (SIGSOFT FSE), 2016, pp. 373–383.
- A. Muscholl, H. Seidl, and I. Walukiewicz, “Reachability for dynamic parametric processes,” in Proceedings of the 18th International Conference on Verification, Model Checking, and Abstract Interpretation (VMCAI), 2017, accepted in 2016.
- W. Chang, D. Roy, Li. Zhang, and S. Chakraborty, “Model-based design of resource-efficient automotive control software,” in Proceedings of the 35th International Conference on Computer-Aided Design (ICCAD), 2016.
- F. Sagstetter, P. Waszecki, S. Steinhorst, M. Lukasiewicz, and S. Chakraborty, “Multischedule synthesis for variant management in automotive time-triggered systems,” *IEEE Trans CAD Integrated Circuits Syst*, vol. 35, no. 4, pp. 637–650, 2016.
- D. Yunge, S. Park, P. Kindt, G. Pravadelli, and S. Chakraborty, “Dynamic service synthesis and switching for medical IoT and ambient assisted living,” in 18th IEEE International High-Level Design Validation and Test Workshop, HLDVT, Santa Cruz, USA, 2016.

## Control and Robotics

- P. Donner and M. Buss, “Cooperative swinging of complex pendulum-like objects: experimental evaluation,” *IEEE Transactions on Robotics*, vol. 32, no. 3, pp. 744–753, 2016.
- A. Turnwald, D. Althoff, D. Wollherr, and M. Buss, “Understanding human avoidance behavior: interaction-aware decision making based on game theory,” *Int. J. Soc. Robot.*, vol. 8, no. 2, pp. 331–351, 2016.
- S. Khan, D. Wollherr, and M. Buss, “Modeling laser intensities for simultaneous localization and mapping,” *IEEE Robotics and Automation Letters*, vol. 1, no. 2, pp. 692–699, 2016.
- R. de Nijs, C. Landsiedel, D. Wollherr, and M. Buss, “Quadratization and roof duality of Markov logic networks,” *J. Artif. Int. Res.*, vol. 55, pp. 685–714, 2016.
- S. Apostolopoulos, M. Leibold, and M. Buss, “Online motion planning over uneven terrain with Walking primitives and regression,” in Proceedings of the 2016 IEEE International Conference on Robotics and Automation (ICRA), Stockholm, Sweden, pp. 3799–3805.
- F. Liu and M. Buss, “Optimal control for information diffusion over heterogeneous networks,” in Proceedings of the 2016 IEEE Conference on Decision and Control (CDC), Las Vegas, USA, pp. 141–146.
- F. Liu and M. Buss, “Node-Based SIRS Model on Heterogeneous Networks: Analysis and Control,” in Proceedings of the 2016 IEEE American Control Conference (ACC), Boston, USA, pp. 2852–2857.
- S. R. Friedrich, and M. Buss, “Direct adaptive-Q control for online performance enhancement of switching linear Systems,” in Proceedings of the 2016 IEEE Conference on Decision and Control (CDC), Las Vegas, USA, pp. 6375–6381.
- R. Hayat and M. Buss, “Model identification for robot manipulators using regressor-free adaptive control,” in Proceedings of the 2016 IEEE International Conference on Control (UKACC), Belfast, UK, pp. 1–7.

### Networked Cyber-Physical Systems

- T. Soleymani, S. Hirche, and J. S. Baras, “Optimal stationary self-triggered sampling for estimation,” in Proc. of the IEEE Conference on Decision and Control (CDC), Las Vegas, USA, 2016.
- T. Soleymani, S. Hirche, and J. S. Baras, “Optimal self-driven sampling for estimation based on value of information,” in Proc. of the IEEE International Workshop on Discrete Event Systems (WODES), Xi’an, China, 2016.
- T. Soleymani, S. Hirche, and J. S. Baras, “Maximization of information in energy-limited directed communication,” in Proc. of the European Control Conference (ECC), Aalborg, Denmark, 2016.
- T. Soleymani, S. Hirche, and J. S. Baras, “Optimal information control in cyber-physical systems,” in Proc. of the IFAC Workshop on Distributed Estimation and Control in Networked Systems (NecSys), Tokyo, Japan, 2016.

### Safe Adaptive Dependable Aerospace Systems (SADAS)

- K. Schilling, “Perspectives for miniaturized, distributed, networked cooperating systems for space exploration,” *Rob. Auton. Syst.*, vol. 90, pp. 118–124, 2016.
- M. E. Kügler, and F. Holzapfel, “Developing automated contingency procedures for the ATOL system of a fixed-wing UAV through online FDD,” in *AIAA Modeling and Simulation Technologies Conference*, Washington, USA, 2016, no. 3221.
- M. Vrdoljak, F. Viertler, M. Hajek, and M. Heller, “Helicopter pilot model for pitch attitude tracking task,” in *Euro GNC 2017 – 4th CEAS Specialist Conference on Guidance, Navigation and Control*, Warsaw, Poland, accepted 2016.
- M. E. Kügler and F. Holzapfel, “Designing a Safe and Robust Automatic Take-off Maneuver for a Fixed-Wing UAV,” in *14th International Conference on Control, Automation, Robotics and Vision (ICARCV)*, Nanyang Technological University and IEEE Control Systems Society, 2016.
- S. Busch, K. Schilling, (eds.), “Technology for Small Satellite Research - Payloads and Subsystem Technologies Small Satellite Applications, Missions, and In-Orbit Experiences,” *International Academy of Astronautics, IAA Book Series, Small Satellite - Programs, Missions, Technologies and Applications*. 2016.
- A. Freimann, T. Tzschichholz, M. Schmidt, A. Kleinschrodt, and K. Schilling, “Applicability of delay tolerant networking to distributed satellite systems,” *CEAS Space Journal*. 2016, pp. 1–10.
- T. Nogueira and K. Schilling, (eds.), “Scaling-up Autonomy for Scaled-down Systems Technology for Small Satellite Research,” *IAA*, 2016, pp. 3–16.
- T. Nogueira, S. Dombrovski, S. Busch, K. Schilling, K. Zakšek, M. Hort, “Photogrammetric Ash Cloud Observations by Small Satellite Formations,” *IEEE Meterology*, Florence, Italy, 2016.
- K. Schilling, “Perspectives for Miniaturized, Distributed, Networked Cooperating Systems for Space Exploration,” *Robotics and Autonomous Systems*, 2016.
- K. Schilling, J. Walter, and S. Kounev, “Spacecraft Autonomous Reaction Capabilities, Control Approaches and Self-Aware Computing,” in: Kounev (ed.), *Self-Aware Computing*, Springer Verlag, 2016.
- E. Karlsson, S. P. Schatz, T. Baier, C. Dörhöfer, A. Gabrys, M. Hochstrasser, C. Krause, P. J. Lauffs, N. Mumm, K. Nürnberger, L. Peter, V. Schneider, P. Spiegel, L. Steinert, A. W. Zollitsch, F. Holzapfel, “Automatic Flight Path Control of an Experimental DA42 General Aviation Aircraft,” in: *International Conference on Control, Automation, Robotics and Vision (ICARCV)*, IEEE, 2016.
- M. E. Kügler and F. Holzapfel, “Developing Automated Contingency Procedures for the ATOL System of a Fixed-Wing UAV through Online FDD,” *AIAA Aviation and Aeronautics Forum and Exposition*, AIAA, 2016.
- G. P. Falconí, J. Angelov, and F. Holzapfel, “Hexacopter Outdoor Flight Test Results Using Adaptive Control Allocation Subject to an Unknown Complete Loss of One Propeller,” in *3rd Conference on Control and Fault-Tolerant Systems (SysTol)*, 2016, pp. 367–374.
- G. C. Krause and F. Holzapfel, “Designing a System Automation for a novel UAV Demonstrator,” In Proc. of *14th International Conference on Control, Automation, Robotics and Vision: ICARCV 2016*, 2016.
- G. P. Falconí, S. P. Schatz, and F. Holzapfel, “Fault Tolerant Control of a Hexarotor using a Command Governor Augmentation,” In *24th Mediterranean Conference on Control and Automation (MED)*, 2016, pp. 182–187.
- C. Heise, S. P. Schatz, and F. Holzapfel, “Modified Extended State Observer Control of Linear Systems,” In *AIAA Science and Technology Forum and Exposition 2016*, 2016.

- P. J. Lauffs and F. Holzapfel, “Hardware-in-the-loop platform for development of redundant smart actuators,” *Aircraft Engineering and Aerospace Technology: An International Journal*, vol. 88, no. 3, pp. 358–364, 2016.
- R. Tekin, K. S. Erer, and F. Holzapfel, “Control of Impact Time with Increased Robustness via Feedback Linearization,” *Journal of Guidance, Control, and Dynamics*, vol. 39, no. 7, pp. 1682–1689, 2016.
- F. Zhang, T. Fricke, and F. Holzapfel, “Integrated Control and Display Augmentation for Manual Remote Flight Control in the Presence of Large Latency,” In *AIAA Guidance, Navigation, and Control Conference*, 2016.
- V. Schneider, P. Piprek, S. P. Schatz, T. Baier, C. Dörhöfer, M. Hochstrasser, et al., “Online Trajectory Generation Using Clothoid Segments,” in: *14th International Conference on Control, Automation, Robotics & Vision (ICARCV)*, Phuket, Thailand, 2016.

## Environmental and Earth Sciences

### Climate Flows

- D. Santucci, T. Auer, and C. Frenzel, “Build simple – Climate engineering 2.0,” in *Proceedings of PLEA 2016 - 32nd International Conference on Passive and Low Energy Architecture. Cities, Buildings, People: Towards Regenerative Environments*, P. LaRoche and M. Schiler, Eds., 2016.
- D. Santucci, E. Mildenerger, and B. Plotnikov, “An investigation on the relation between outdoor comfort and people’s mobility: the Elytra Filament Pavilion survey,” in *PowerSkin Conference Proceedings*, Munich, Germany, pp. 97–107, 2017, accepted in 2016.

### Environmental Sensing and Modeling

- J. Chen, C. Viatte, J. K. Hedelius, T. Jones, J. E. Franklin, H. Parker, E. W. Gottlieb, P. O. Wennberg, M. K. Dubey, and S. C. Wofsy, “Differential column measurements using compact solar-tracking spectrometers,” *Atmos. Chem. Phys.*, vol. 16, pp. 8479–8498, 2016.
- J. Chen, J. K. Hedelius, C. Viatte, T. Jones, J. E. Franklin, H. Parker, E. W. Gottlieb, P. O. Wennberg, M. K. Dubey, and S. C. Wofsy, “Study of differential column measurements for urban greenhouse gas emission monitoring,” in *EGU General Assembly 2016*, Vienna, Austria, vol. 18, p. 3244.
- J. K. Hedelius, C. Viatte, D. Wunch, C. Roehl, G. C. Toon, J. Chen, T. Jones, S. C. Wofsy, J. E. Franklin, H. Parker, M. K. Dubey, and P.O. Wennberg, “Assessment of errors and biases in retrievals of XCO<sub>2</sub>, XCH<sub>4</sub>, XCO, and XN<sub>2</sub>O from a 0.5 cm<sup>-1</sup> resolution solar viewing spectrometer,” *Atmos. Meas. Tech.*, vol. 9, no.8, pp. 3527–3546, 2016.
- S. Wan, Y. Zhang, and J. Chen, “On the construction of data aggregation tree with maximizing lifetime in large scale wireless sensor networks,” *IEEE Sensors Journal*, vol. 16, no. 20, pp. 7433–7440, 2016.
- Y. Wu, X. Wu, D. Lebrun, M. Brunel, S. Coëtmelec, O. Lesouhaitier, J. Chen, and G. Gréhan, “Intrinsic spatial shift of local focus metric curves in digital inline holography for accurate 3D morphology measurement of irregular micro-objects,” *Appl. Phys. Lett.*, vol. 109, no. 121903, 2016.
- A. Z. Dhunny, F. Toja-Silva, C. Peralta, M. R. Lollchund, and S. D. D. V. Rughooputh, “Computational fluid dynamics simulation and full-scale experimental model inter-comparison of the wind flow around a university campus,” *Wind Eng.*, vol. 41, no. 1, pp. 43–54, 2017, accepted in 2016.
- Y. Wu, J. Promvongsa, S. Saengkaew, X. Wu, J. Chen, and G. Gréhan, “Phase rainbow refractometry for accurate droplet variation characterization,” *Opt. Lett.*, vol. 41, no. 20, pp. 4672–4675, 2016.
- J. Chen, L. Heinle, J. Paetzold, and L. Le, “Total column greenhouse gas monitoring in Central Munich: automation and measurements,” in *EGU General Assembly 2016*, Vienna, Austria, vol. 18, p. 3247.

### Global Change

- S. Jochner, T. H. Sparks, J. Laube, and A. Menzel, “Can we detect a nonlinear response to temperature in European plant phenology?,” *Int. J. Biometeorol.*, vol. 60, no. 10, pp. 1551–1561, 2016.
- A. Menzel, M. Matiu, R. Michaelis, and S. Jochner, “Indoor birch pollen concentrations differ with ventilation scheme, room location and meteorological factors,” *Indoor Air*, 2016.
- Y. Fu, Y. Liu, H. De Boeck, A. Menzel, I. Nijs, M. Peaucelle, J. Penuelas, S. Piao, and I. Janssens, “Long-term linear trends mask phenological shifts,” *Int. J. Biometeorol.*, vol. 60, no. 11, pp. 1611–1613, 2016.

- Y. Fu, Y. Liu, H. De Boeck, A. Menzel, I. Nijs, M. Peaucelle, J. Penuelas, S. Piao, and I. Janssens, "Three times greater weight of daytime than of night-time temperature on leaf unfolding phenology in temperate trees," *New Phytologist*, vol. 212, no. 3, pp. 590–597, 2016.
- E. Kolářová, M. Matiu, A. Menzel, J. Nekovář, P. Lumpe, and P. Adamík, "Changes in spring arrival dates and temperature sensitivity of migratory birds over two centuries," *Int. J. Biometeorol.*, 2017, accepted in 2016.
- C. Kraus, C. Zang, and A. Menzel, "Elevational response in leaf and xylem phenology reveals different prolongation of growing period of common beech and Norway spruce under warming conditions in the Bavarian Alps," *Eur. J. For. Res.*, vol. 135, no. 6, pp. 1011–1023, 2016.
- M. Leuchner, H. Ghasemifard, M. Lüpke, L. Ries, C. Schunk, and A. Menzel, "Seasonal and diurnal variation of formaldehyde and its meteorological drivers at the GAW site Zugspitze," *Aerosol Air Quality Res.*, vol. 16, no. 3, pp. 801–815, 2016.
- M. Lüpke, M. Leuchner, R. Steinbrecher, and A. Menzel, "Impact of summer drought on isoprenoid emissions and carbon sink of three Scots pine provenances," *Tree Physiol.*, vol. 36, no. 11, pp. 1382–1399, 2016.
- K.-H. Mellert, J. Ewald, D. Hornstein, I. Dorado-Liñán, M. Jantsch, S. Taeger, C. Zang, A. Menzel, and C. Kölling, "Climatic marginality: a new metric for the susceptibility of tree species to warming exemplified by *Fagus sylvatica* (L.) and Ellenberg's quotient," *Eur. J. Forest Res.*, vol. 135, no. 1, pp. 137–152, 2016.
- G. Misra, A. Buras, and A. Menzel, "Effects of different methods on the comparison between land surface and ground phenology – a methodological case study from south-western Germany," *Remote Sensing*, vol. 8, no. 9, 2016.
- C. Schunk, B. Ruth, M. Leuchner, C. Wastl, and A. Menzel, "Comparison of different methods for the in-situ measurement of forest litter moisture content," *Nat. Hazards Earth Syst. Sci.*, vol. 16, pp. 403–415, 2016.
- C. Schunk, C. Wastl, M. Leuchner, and A. Menzel, "Fine fuel moisture for site- and species-specific fire danger assessment in comparison to fire danger indices," *Agric. For. Meteorol.*, vol. 234, pp. 31–47, 2016.
- H. Seidel, and A. Menzel, "Above-ground dimensions and acclimation explain variation in drought mortality of Scots pine seedlings from various provenances," *Front Plant Sci.*, vol. 7, no. 1014, 2016.
- H. Seidel, C. Schunk, M. Matiu, and A. Menzel, "Diverging drought resistance of scots pine provenances revealed by infrared thermography," *Front Plant Sci.*, vol. 7, no. 1247, 2016.

### Modeling Spatial Mobility

- C. Dawkins and R. Moeckel, "Transit-induced gentrification: who will stay, and who will go?," *Housing Policy Debate*, vol. 26, no. 4–5, pp. 801–818, 2016.
- R. Moeckel and K. Nagel, "Maintaining mobility in substantial urban growth futures," *Transport Res. Procedia*, vol. 19, pp. 70–80, 2016.
- H. Shahumyan and R. Moeckel, "Integration of land use, land cover, transportation and environmental impact models: Expanding scenario analysis with multiple modules," *Environ. Plann. B*, 2016.
- D. Ziemke, K. Nagel, and R. Moeckel, "Towards an agent-based, integrated land-use transport modeling system," *Procedia Comput. Sci.*, vol. 83, pp. 958–963, 2016.
- R. Moeckel and R. Donnelly, "A model for national freight flows, distribution centers, empty trucks and urban truck movements," *Transport Plan. Techn.*, vol. 39, no. 7, pp. 693–711, 2016.
- R. Moeckel and D. Yang, "Car ownership and the impact of built environment, demographics and transport systems," *J. Civil Eng. Archit.*, vol. 10, no. 5, pp. 587–595, 2016.
- M. B. Okrah, "Evaluation of methods for estimation of intrazonal travel impedances," *Transport Res Record: J. Transport Res. Board*, vol. 2563, pp. 114–121, 2016.
- M. B. Okrah, G. Wulfhorst, and R. Moeckel, "Finding the optimal level of spatial resolution for handling non-motorized travel in macroscopic travel demand models," in *14th World Conference on Transport Research*, WCTR, Shanghai, China, 2016.
- A. T. Moreno, C. Llorca, S. Washburn, J. E. Bessa, D. K. Hale, and A. Garcia, "Modification of the highway capacity manual two-lane highway analysis Procedure for Spanish Conditions," *J. Adv. Transport*, 2016.

- C. Llorca and H. Farah, "Passing behavior on two-lane roads in a real and in a simulated environment," *Transport Res. Record*, vol. 2556, pp. 29–38, 2016.
- C. Llorca, A. T. Moreno, and A. Garcia, "Modeling vehicles acceleration during overtaking manoeuvres," *IET Intell. Transport*, vol. 10, no. 3, pp. 206–215, 2016.
- M. D. Martín-Gasulla, A. Garcia, and A. T. Moreno, "Benefits of Metering Signals at Roundabouts with Unbalanced Flows Patterns in Spain," *Transport Res. Record*, vol. 2585, pp. 20–28, 2016.
- R. Moeckel and R. Donnelly, "Mega-region modeling on the rise: how statewide models morph into mega-region models," in 96th Annual Meeting of the Transportation Research Board, Washington, D.C., USA, 2017, accepted in 2016.
- R. Moeckel, "Modeling the impact of communication technologies on transportation and land use," in 96th Annual Meeting of the Transportation Research Board, Washington, D.C., USA, 2017, accepted in 2016.
- A. T. Moreno and R. Moeckel, "A framework to respect travel time budgets as constraint for microscopic destination choice modeling," in 96th Annual Meeting of the Transportation Research Board, Washington, D.C., USA, 2017, accepted in 2016.
- D. K. Hale, H. Mahmassani, A. Paz, A.T. Moreno, S. Ozkul, and Z. Huang, "Dynamic lane grouping analytical methods for signalized intersections," in 96th Annual Meeting of the Transportation Research Board, Washington, D.C., USA, 2017, accepted in 2016.
- A. T. Moreno, "Operational Criteria for Spanish Two-Lane Highways. Passing and alignment considerations," in 96th Annual Meeting of the Transportation Research Board, Washington, D.C., USA, 2017, accepted in 2016.
- S. Torres, C. Llorca, and A. Garcia, "Operating Speed of Sport Cyclists on Two-Lane Rural Roads," in 96th Annual Meeting of the Transportation Research Board, Washington, D.C., USA, 2017, accepted in 2016.
- M. Gasulla, A. Garcia, and C. Llorca, "Headway Acceptance Decisions on Single-Lane Roundabouts in Spain: Critical and Follow-Up Headway," in 96th Annual Meeting of the Transportation Research Board, Washington, D.C., USA, 2017, accepted in 2016.
- A. T. Moreno, C. Llorca, and A. Garcia, "Diseño de zonas de adelantamiento para la mejora de la seguridad y la funcionalidad de carreteras convencionales," in VI Edición del Premio Internacional a la Innovación en Carreteras Juan Antonio Fernández del Campo, Madrid, Spain, 2016.
- A. T. Moreno, C. Llorca, and A. Garcia "Metodología para analizar la funcionalidad del tráfico en carreteras convencionales en España," *Plataforma Tecnológica de la Carretera*, 2016.
- A. Garcia, C. Llorca, and J. Serra, "Influence of Peloton Configuration on the Interaction Between Sport Cyclists and Motor Vehicles on Two-lane Rural Roads," in 5th International Cycling Safety Conference, Bologna, Italy, 2016.
- A. Lenorzer, A. T. Moreno, and C. Llorca, "Microscopic model for two-lane rural models and its application," in European Transport Conference, Barcelona, Spain, 2016.
- R. Moeckel, "Working from home: Modeling the impact of telework on transportation and land use," in European Transport Conference, Barcelona, Spain, 2016.
- D. Yang, R. Moeckel, D. Engelberg, and F. Ducca, "Planning for Sustainability at the Regional Level: An Integrated Transportation, Land Use and Environment Modeling System," in 14th World Conference on Transport Research (WCTR), Shanghai, China, 2016.
- A. T. Moreno, and R. Moeckel, "Microscopic Destination Choice: Incorporating Travel Time Budgets as Constraints," in 14th World Conference on Transport Research (WCTR), Shanghai, China, 2016.
- M. D. Martín-Gasulla, A. Garcia, A. T. Moreno, and C. Llorca, "Capacity and operational improvements of metering roundabouts in Spain," *TRPRO*, vol. 15, pp. 295–307, 2016.
- A. T. Moreno, C. Llorca, and A. Garcia, "Operational Impact of Horizontal and Vertical Alignment of Two-Lane Highways," *TRPRO*, vol. 15, pp. 319–330, 2016.
- A. Lenorzer, and A. T. Moreno "Simulation of Rural Highways with Aimsun," in ISEHP, Berlin, German, 2016.
- M. Okrah, "Handling Non-Motorized Trips in Travel Demand Models," in Sustainable Mobility in Metropolitan Regions, G. Wulfhorst and S. Klug, Eds. Wiesbaden: Springer, 2016, ch. 9, pp. 155–171.
- R. Moeckel, "Modeling the Impact of Communication Technologies on Transportation and Land Use," in 96th Annual Meeting of the Transportation Research Board, Washington, D.C., USA, 2017, accepted in 2016.

- H. Shahumyan, R. Moeckel, P. Claggett, and F. Ducca, “Integration of Land Use and Land Cover Models: Linking Two Siblings to Improve Simulation of Location Choice,” in 8th International Congress on Environmental Modeling and Software, Toulouse, France, 2016.

### High-Resolution Gravity Modeling

- C. Hirt, E. Reußner, M. Rexer, and M. Kuhn, “Topographic gravity modeling for global Bouguer maps to degree 2,160: validation of spectral and spatial domain forward modeling techniques at the 10 microgal level,” *J. Geophys. Res. Solid Earth*, vol. 121, no. 9, pp. 6846–6862, 2016.
- M. Rexer, C. Hirt, S. J. Claessens, and R. Tenzer, “Layer-based modeling of the Earth’s gravitational potential up to 10km-scale in spherical harmonics in spherical and ellipsoidal approximation,” *Surveys Geophys.*, vol. 37, no. 6, pp. 1035–1074, 2016.
- M. Rexer, and C. Hirt, “Evaluation of intermediate TanDEM-X digital elevation data products over Tasmania using other digital elevation models and accurate heights from the Australian National Gravity Database,” *Aust. J. Earth Sci.*, vol. 63, no. 5, pp. 599–609, 2016.
- M. Kuhn, and C. Hirt, “Topographic gravitational potential up to second-order derivatives: an examination of approximation errors caused by rock-equivalent topography (RET),” *J. Geodesy*, vol. 90, no. 9, pp. 883–902, 2016.
- M. Hauk, C. Hirt, and C. Ackermann, “Experiences with the QDaedalus system for astrogeodetic determination of deflections of the vertical,” *Survey Rev.*, vol. 48, no. 34, pp. 1–8, 2016.
- C. Hirt, M. Rexer, M. Scheinert, R. Pail, S. Claessens, and S. Holmes, “A new degree-2190 (10 km resolution) gravity field model for Antarctica developed from GRACE, GOCE and Bedmap2 data,” *J. Geodesy*, vol. 90, no. 2, pp. 105–127, 2016.
- R. Tenzer, C. Hirt, P. Novák, M. Pitonák, and M. Šprlák, “Contribution of mass density heterogeneities to the quasigeoid-to-geoid separation,” *J. Geodesy*, vol. 90, no. 1, pp. 65–80, 2016.
- C. Hirt, “Topographische Modellierung des Gravitationsfeldes,” in *Handbuch der Geodäsie*, W. Freeden und R. Rummel, Eds. Berlin, New York: Springer, 2016.
- C. Hirt, “Gravity Forward Modeling,” in *Encyclopedia of Geodesy*, E. Grafarend, Ed. Berlin, New York: Springer, 2016.
- R. Pail, “Globale Schwerefeldmodellierung am Beispiel von GOCE,” in *Handbuch der Geodäsie*, W. Freeden und R. Rummel, Eds. Berlin, New York: Springer, 2016.

## Fundamental Natural and Life Sciences

### Fundamental Physics

- A. J. Buras, and F. De Fazio, “ $\epsilon'/\epsilon$  in 331 models,” *J High Energy Phys*, vol. 3, pp. 10–31, 2016.
- A. J. Buras, “New physics patterns in  $\epsilon'/\epsilon$  and  $\epsilon$  with implications for rare kaon decays and  $\Delta M_K$ ,” *J High Energy Phys*, vol. 4, pp. 71–105, 2016.
- A. J. Buras, “Flavour physics: Status and perspectives,” *Ann Phys*, vol. 528, no. 1–2, pp. 96–101, 2016.
- M. Blanke and A. J. Buras, “Universal unitarity triangle 2016 and the tension between  $\Delta M_{s,d}$  and  $\epsilon_K$  in CMFV models,” *Eur Phys J C*, vol. 76, no. 4, pp. 197–213, 2016.
- A. J. Buras, and F. De Fazio, “ $\Delta F = 2$  Processes with the Impact on  $\epsilon'/\epsilon$ ,  $B^s \rightarrow \mu^+\mu^-$  and  $B \rightarrow K^*\mu^+\mu^-$ ,” *J High Energy Phys*, vol.8, pp. 115–146, 2016.
- A. J. Buras, “The Renaissance of Kaon Flavour Physics,” *PoS BEAUTY 2016*, Marseille, France, 2016, pp. 32–60.
- A. J. Buras, “The Revival of Kaon Flavour Physics,” *EPJ Web Conf*, vol. 129, pp. 50–62, 2016.

### Biochemistry

- O. V. Maltsev, U. Kiran Marelli, T. G. Kapp, F. S. Di Leva, S. Di Maro, M. Nieberler, U. Reuning, M. Schwaiger, E. Novellino, L. Marinelli, and H. Kessler, “Stable peptides instead of stapled peptides: highly potent  $\alpha_v\beta_6$ -selective integrin ligands,” *Angew. Chem., Int. Ed.*, vol. 55, no. 4, pp. 1535–1538, 2016.
- J. Notni, K. Steiger, F. Hoffmann, D. Reich, T. G. Kapp, F. Rechenmacher, S. Neubauer, H. Kessler, and H.-J. Wester, “A match made in heaven: Complementary, selective PET-imaging of integrin subtypes  $\alpha_5\beta_1$  and  $\alpha_v\beta_3$  using Ga-68-Aquibeptrin and Ga-68-Avebetrin,” *J. Nucl. Med.*, vol. 57, no. 3, pp. 460–466, 2016.



- J. Notni, D. Reich, O. V. Maltsev, T. G. Kapp, K. Steiger, F. Hoffmann, V. Stiegler, I. Esposito, W. Weichert, H. Kessler, and H.-J. Wester, “*In-vivo* PET imaging of the ‘cancer integrin’  $\alpha_v\beta_6$  using gallium-68 labelled cyclic RGD nonapeptides,” *J. Nucl. Med.*, vol. 58, 2017, accepted in 2016.
- C. Mas-Moruno, R. Fraioli, F. Rechenmacher, S. Neubauer, T. G. Kapp, and H. Kessler, “ $\alpha_v\beta_3$ - or  $\alpha_5\beta_1$ -integrin-selective peptidomimetics for surface coating,” *Angew. Chem. Int. Ed.* 2016, vol. 55, no. 25, pp. 7048–7067, 2016.
- D. Missirlis, T. Haraszti, C. v. C. Scheele, T. Wiegand, C. Diaz, S. Neubauer, F. Rechenmacher, H. Kessler, and J. P. Spatz, “Substrate engagement of integrins  $\alpha_5\beta_1$  and  $\alpha_v\beta_3$  is necessary, but not sufficient, for high directional persistence in migration on fibronectin,” *Sci. Rep.*, vol. 6, p. 23258, 2016.
- V. Schaufler, H. Czichos-Medda, V. Hirschfeld-Warnecken, S. Neubauer, F. Rechenmacher, R. Medda, H. Kessler, B. Geiger, J. P. Spatz, and E. A. Cavalcanti-Adam, “Selective binding and lateral clustering of  $\alpha_5\beta_1$  and  $\alpha_v\beta_3$  integrins: unraveling the spatial requirements for cell spreading and focal adhesion assembly,” *Cell Adh. Migr.*, vol. 10, no. 5, pp. 505–515, 2016.

### Biomolecular Design

- J. J. Funke, P. Ketterer, C. Lieleg, P. Korber, and H. Dietz, “Exploring nucleosome unwrapping using DNA origami,” *Nano Lett.*, vol. 16, no. 12, pp. 7891–7898, 2016.
- J. J. Funke, P. Ketterer, C. Lieleg, S. Schunter, P. Korber, and H. Dietz, “Uncovering the forces between nucleosomes using DNA origami,” *Sci. Adv.*, vol. 2, no. 11, p. e1600974, 2016.
- T. Martin, T. Bharat, A. Joerger, X. Bai, F. Praetorius, A. Fersht, H. Dietz, and S. Scheres, “The design of a molecular support for cryo-EM structure determination,” *Proc. Natl. Acad. Sci. U.S.A.*, vol. 113, no. 47, pp. E7456–E7463, 2016.
- B. Kick, S. Hensler, F. Praetorius, H. Dietz, and D. Weuster-Botz, “Specific growth rate and multiplicity of infection affect high-cell-density fermentation with bacteriophage M13 for ssDNA production,” *Biotechn. Bioeng.*, vol. 114, no. 4, pp. 777–784, 2017, accepted in 2016.
- F. Kilchherr, C. Wachauf, B. Pelz, M. Rief, M. Zacharias, and H. Dietz, “Single-molecule dissection of stacking forces in DNA,” *Science*, vol. 353, no. 6304, p. aaf5508, 2016.
- S. Krishnan, D. Ziegler, V. Arnaut, T. G. Martin, K. Kapsner, K. Henneberg, A. R. Bausch, H. Dietz, and F. C. Simmel, “Molecular transport through large-diameter DNA nanopores,” *Nat. Commun.*, vol. 7, no. 12787, p. 12787, 2016.
- E. Stahl, F. Praetorius, C. C. de Oliveira-Mann, K. Hopfner, and H. Dietz, “Impact of heterogeneity and lattice bond strength of DNA triangle crystal growth,” *ACS Nano*, vol. 10, no. 10, pp. 9156–9164, 2016.
- L. Rodrigues, K. Kyriakos, F. Schneider, H. Dietz, G. Winter, C. M. Papadakis, and M. Hubert, “Characterization of lipid-based hexosomes as versatile vaccine carriers,” *Mol. Pharmaceutics*, vol. 13, no. 11, pp. 3945–3954, 2016.
- L. K. Bruetzel, T. Gerling, S. M. Sedlak, P. U. Walker, W. Zheng, H. Dietz, and J. Lipfert, “Conformational changes and flexibility of DNA devices observed by small-angle X-ray scattering,” *Nano Lett.*, vol. 16, no. 8, pp. 4871–4879, 2016.
- H. Dietz, “Toward Applications for DNA Nanotechnology - More Bricks to Build with,” *ChemBioChem*, vol. 17, no. 12, pp. 1046-1047, 2016.
- P. Ketterer, E. M. Willner, and H. Dietz, “Nanoscale rotary apparatus formed from tight-fitting 3D DNA components,” *Sci. Adv.*, vol. 2, no. 2, p. e1501209, 2016.

### Cellular Protein Biochemistry

- J. Behnke, M. J. Mann, F. L. Scruggs, M. J. Feige, and L. M. Hendershot, “Members of the Hsp70 family recognize distinct types of sequences to execute ER quality control,” *Mol. Cell*, vol. 63, no. 5, pp. 739–752, 2016.

### Chemical Catalysis, Photo-catalysis and Electro-catalysis

- S. P. Rittmeyer, D. J. Ward, P. Gütlein, J. Ellis, W. Allison, and K. Reuter, “Energy dissipation during diffusion at metal surfaces: disentangling the role of phonons versus electron-hole pairs,” *Phys. Rev. Lett.*, vol. 117, no. 19, pp. 196001-1–196001-5, 2016.

### Functional Metagenomics

- T. Goldberg, B. Rost, and Y. Bromberg, “Computational prediction shines light on type III secretion origins,” *Nat. Sci. Rep.*, vol. 6, no. 34516, 2016.
- Y. Bromberg, M. W. Hahn, and P. Radivojac, “Computational approaches to the understanding of evolution of molecular function,” in *Proceedings of the Pacific Symposium on Biocomputing*, Hawaii, USA, 2016, vol. 22, pp. 1–2.

### Integrative Structural Biology

- A. Deckert, C. A. Waudby, T. Wlodarski, A. S. Wentink, X. Wang, J. P. Kirkpatrick, J. F. S. Paton, C. Camilloni, P. Kukic, C. M. Dobson, M. Vendruscolo, L. D. Cabrita, and J. Christodoulou, “Structural characterization of the interaction of  $\alpha$ -synuclein nascent chains with the ribosomal surface and trigger factor,” *Proc. Natl. Acad. Sci. USA*, vol. 113, no. 18, pp. 5012–5017, 2016.
- L. D. Cabrita, A. M. E. Cassaignau, H. M. M. Launay, C. A. Waudby, T. Wlodarski, C. Camilloni, M.-E. Karyadi, A. L. Robertson, X. Wang, A. S. Wentink, L. S. Goodsell, C. A. Woolhead, M. Vendruscolo, C. M. Dobson, and J. Christodoulou, “A structural ensemble of a ribosome-nascent chain complex during cotranslational protein folding,” *Nat. Struct. Mol. Biol.*, vol. 23, no. 4, pp. 278–285, 2016.
- M. Bonomi, C. Camilloni, A. Cavalli, and M. Vendruscolo, “Metainference: A Bayesian inference method for heterogeneous systems,” *Sci. Adv.*, vol. 2, no. 1, p. e1501177, 2016.
- C. Camilloni, B. M. Sala, P. Sormanni, R. Porcari, A. Corazza, M. De Rosa, S. Zanini, A. Barbiroli, G. Esposito, M. Bolognesi, V. Bellotti, M. Vendruscolo, and S. Ricagno, “Rational design of mutations that change the aggregation rate of a protein while maintaining its native structure and stability,” *Sci. Rep.*, vol. 6, no. 25559, 2016.
- M. Bonomi, C. Camilloni, and M. Vendruscolo, “Metadynamic metainference: Enhanced sampling of the metainference ensemble using metadynamics,” *Sci. Rep.*, vol. 6, p. 31232, 2016.
- D. Bonetti, C. Camilloni, L. Visconti, S. Longhi, M. Brunori, M. Vendruscolo, and S. Gianni, “Identification and Structural Characterization of an Intermediate in the Folding of the Measles Virus X domain,” *J. Biol. Chem.*, vol. 291, no. 20, pp. 10886–10892, 2016.
- R. Meloni, C. Camilloni, and G. Tiana, “Properties of low-dimensional collective variables in the molecular dynamics of biopolymers,” *Phys. Rev. E*, vol. 94, no. 5, p. 052406, 2016.

### Physics with Effective Field Theories

- A. Bazavov, N. Brambilla, H.-T. Ding, P. Petreczky, H.-P. Schadler, A. Vairo, and J. H. Weber, “Polyakov loop in 2+1 flavor QCD from low to high temperatures,” *Phys. Rev. D*, vol. 93, no. 11, art. 114502, 2016.
- S. Biondini, N. Brambilla, and A. Vairo, “CP properties of heavy Majorana neutrinos at finite temperature: the hierarchical case,” *J. High En. Phys.*, vol. 1609, art. 126, 2016.
- A. Bazavov, C. Bernard, C. M. Bouchard, C. C. Chang, C. DeTar, D. Du, A. X. El-Khadra, E. D. Freeland, E. Gamiz, S. Gottlieb, U. M. Heller, A. S. Kronfeld, J. Laiho, P. B. Mackenzie, E. T. Neil, J. Simone, R. Sugar, D. Toussaint, R. S. Van de Water, R. Zhou, “ $B^0$ -mixing matrix elements from lattice QCD for the Standard Model and beyond,” *Phys. Rev. D*, vol. 93, no. 11, art. 113016, 2016.
- Jon A. Bailey, A. Bazavov, C. Bernard, C. M. Bouchard, C. DeTar, D. Du, A. X. El-Khadra, J. Foley, E. D. Freeland, E. Gámiz, S. Gottlieb, U. M. Heller, R. D. Jain, J. Komijani, A. S. Kronfeld, J. Laiho, L. Levkova, Yuzhi Liu, P. B. Mackenzie, Y. Meurice, E. T. Neil, Si-Wei Qiu, J. N. Simone, R. Sugar, D. Toussaint, R. S. Van de Water, Ran Zhou), “ $B \rightarrow Kl^+l^-$  decay form factors from three-flavor lattice QCD,” *Phys. Rev. D*, vol. 93, no. 2, art. 025026, 2016.
- D. Du, A. X. El-Khadra, S. Gottlieb, A. S. Kronfeld, J. Laiho, E. Lunghi, R. S. Van de Water, and R. Zhou, “Phenomenology of semileptonic B-meson decays with form factors from lattice QCD,” *Phys. Rev. D*, vol. 93, no. 3, art. 034005, 2016.
- M. Berwein, N. Brambilla, P. Petreczky, and A. Vairo, “Polyakov loop at next-to-next-to leading order,” *Phys. Rev. D*, vol. 93, no. 3, art. 034005, 2016.
- N. Brambilla, G. Krein, J. Tarrús Castellà, and A. Vairo, “Long-range properties of 1S bottomonium states,” *Phys. Rev. D*, vol. 93, no. 5, art. 054002, 2016.
- A. Bazavov, C. Bernard, C. Bouchard, N. Brown, C. DeTar, D. Du, A. X. El-Khadra, E. D. Freeland, E. Gámiz, S. Gottlieb, U. M. Heller, J. Komijani, A. S. Kronfeld, J. Laiho, L. Levkova, P. B. Mackenzie, C. Monahan, T. Primer, H. Na, E. T. Neil, J. N. Simone, R. L. Sugar, D. Toussaint, R. S. Van de Water,

- R. Zhou, "Decay constants  $f_B$  and  $f_{B_s}$  from HISQ Simulations," in 34th International Symp. On Lattice Field Theory, Southampton, UK, 2016.
- J. Komijani, A. Bazavov, C. Bernard, N. Brambilla, N. Brown, C. DeTar, D. Du, A. X. El-Khadra, E. D. Freeland, E. Gámiz, S. Gottlieb, U. M. Heller, A. S. Kronfeld, J. Laiho, P. B. Mackenzie, C. Monahan, H. Nae, E. T. Neil, J. N. Simone, R.L. Sugar, D. Toussaint, A. Vairo, R. S. Van de Water, "Decay constants  $f_B$  and  $f_{B_s}$  and quark masses  $m_b$  and  $m_c$  from HISQ Simulations," in 34th International Symp. On Lattice Field Theory, Southampton, UK, 2016.
  - S. Biondini, N. Brambilla, and A. Vairo, "CP properties of heavy Majorana neutrinos at finite temperature: the nearly degenerate case," *J. High Energy Phys.*, vol. 1603, 2016.
  - T. Primer, D. Toussaint, C. Bernard, J. Komijani, C. DeTar, A. El-Khadra, E. Gámiz, A. Kronfeld, J. Simone, R. Van De Water, "D-meson semileptonic form factors at zero momentum transfer in (2+1+1)-flavor lattice QCD," *Proc. Sci.*, vol. LATTICE2015, art. 338, 2016.
  - M. Lutz, J. S. Lange, M. Pennington, D. Bettoni, N. Brambilla, V. Crede, S. Eidelman, A. Gillitzer, W. Gradl, C. B. Lang, V. Metag, J. Nieves, S. Neubert, M. Oka, S. L. Olsen, M. Pappagallo, S. Paul, M. Pelizáus, A. Pilloni, E. Prencipe, J. Ritman, S. Ryan, U. Thoma, U. Uwer, W. Weise, "Resonances in QCD," *Nucl. Phys. A*, vol. 948, pp. 93–105, 2016.
  - J. A. Bailey, Y.-C. Jang, W. Lee, C. DeTar, A. S. Kronfeld, and M. B. Oktay, "Update on tests of the Oktay-Kronfeld action," *Proc. Sci.*, vol. LATTICE2015, art. 099, 2016.
  - A. Bazavov, C. Bernard, N. Brown, C. DeTar, J. Foley, S. Gottlieb, U. M. Heller, J. Komijani, J. Laiho, L. Levkova, R. L. Sugar, D. Toussaint, R. S. Van de Water, "Gradient flow and scale setting on MILC HISQ ensembles," *Phys. Rev. D*, vol. 93, art. 094510, 2016.
  - A. Adrianov, N. Brambilla, V. Kim, and S. Kolevatov, "Proceedings, Eleventh Conference on Quark Confinement and the Hadron Spectrum," *AIP Conf. Proc.*, vol. 1701, 2016.
  - A. S. Meyer, R. J. Hill, A. S. Kronfeld, R. Li, and J. N. Simone, "Calculation of the nucleon axial form factor using staggered lattice QCD," in 34th International Symp. On Lattice Field Theory, Southampton, UK, 2016.
  - E. Gámiz, A. Bazavov, C. Bernard, C. DeTar, D. Du, A. X. El-Khadra, E. D. Freeland, S. Gottlieb, U. M. Heller, J. Komijani, A. S. Kronfeld, J. Laiho, P. B. Mackenzie, E.T.Neil, T. Primer, J.N. Simone, R. Sugar, D. Toussaint, R. S. Van de Water, and Ran Zhou, "Kaon semileptonic decays with  $N_f = 2+1+1$  HISQ fermions and physical light-quark masses," in 34th International Symp. On Lattice Field Theory, Southampton, UK, 2016.

### Population Epigenetics and Epigenomics

- A. Taudt, M. Colome-Tatche, and F. Johannes, "Genetic sources of population epigenomic variation," *Nat. Rev. Genet.*, vol. 17, no. 6, pp. 319–332, 2016.
- A. Vidali, D. Živković, R. Wardenaar, D. Roquis, A. Tellier, F. Johannes, "Methylome evolution in plants," *Genome Biol.*, vol. 17, no. 1, pp. 264–277, 2016.
- W. Diao, M. Mousset, C. J. Vermeulen, F. Johannes, L. van de Zande, M. G. Ritchie, T. Schmitt, L. W. Beukeboom, "Quantitative trait locus analysis of mating behavior and male sex pheromones in *Nasonia* wasps," *G3*, vol. 6, pp. 1549–1562, 2016.

### Protein Misfolding and Amyloid Diseases

- D. C. Rodriguez Camargo, K. Tripsianes, K. Buday, A. Franko, C. Göbl, C. Hartmüller, R. Sarkar, M. Aichler, G. Mettenleiter, M. Schulz, A. Böddrich, C. Erck, H. Martens, A. K. Walch, T. Madl, E. E. Wanker, M. Conrad, M. Hrabě de Angelis, and B. Reif, "The redox environment triggers conformational changes and aggregation of hIAPP in Type II Diabetes," *Nat. Sci. Rep.*, vol. 7, art. 44041, 2017.

### Sterile Neutrino and Dark Matter

- K. Dolde, S. Mertens, D. Radford, T. Bode, A. Huber, M. Korzeczek, T. Lasserre, and M. Slezak, "Impact of ADC non-linearities on the sensitivity to sterile keV neutrinos with a KATRIN-like experiment," *Nuc. Instrum. Methods Phys. Res. A*, vol. 848, no. 8, pp. 127–136, 2017, accepted in 2016.
- T. Lasserre, K. Altenmueller, M. Cribier, A. Merle, S. Mertens, and M. Vivier, "Direct search for keV sterile neutrino dark matter with a stable dysprosium target," 2017, accepted in 2016.
- R. Adhikari, M. Drewes, T. Lasserre, S. Mertens, A. Merle, et al., "A white paper on keV sterile neutrino dark matter," *JCAP*, vol. 2017, no. 1, p. 025, 2017, accepted in 2016.

### Structural Membrane Biochemistry

- D. Goricanec, R. Stehle, P. Egloff, S. Grigoriu, A. Plückthun, G. Wagner, and F. Hagn, "Conformational dynamics of a G-protein  $\alpha$  subunit is tightly regulated by nucleotide binding," *Proc. Natl. Acad. Sci. USA*, vol. 113, no. 26, pp. E362–E3638, 2016.
- A. Enthart, C. Klein, A. Dehner, M. Coles, G. Gemmecker, H. Kessler, and F. Hagn, "Solution structure and binding specificity of the p63 DNA binding domain," *Sci. Rep.*, vol. 6, p. 26707, 2016.
- M. L. Nasr, D. Baptista, M. Strauss, Z. J. Sun, S. Grigoriu, S. Huser, A. Plückthun, F. Hagn, T. Walz, J. M. Hogle, and G. Wagner, "Covalently circularized nanodiscs for studying membrane proteins and viral entry," *Nat. Methods*, vol. 14, no. 1, pp. 49–52, 2016.

### Supramolecular Chemistry

- T. Tantakitti, J. Boekhoven, X. Wang, R. Kazantsev, T. Yu, J. Li, E. Zhuang, F. Zandi, J. Ortony, C. Newcomb, L. Palmer, S. M. Gajendra de la Cruz, G. Schatz, and S. Stupp, "Energy landscapes of supramolecular systems determine their function," *Nat. Mater.*, vol. 15, no. 4, pp. 469–476, 2016.

### Synthetic Biochemistry

- S. Mayer and K. Lang, "Tetrazines in inverse-electron-demand Diels–Alder cycloadditions and their use in biology," *Synthesis*, vol. 49, no. 4, pp. 830–848, 2017, accepted in 2016.
- S. Mayer and K. Lang, "Chemie in lebenden Systemen," *Nachr. Chem.*, vol. 64, no. 3, pp. 301–305, 2016.
- L. Jiao and K. Lang, "The 6th Sino–German Frontiers of Chemistry Symposium," *Chemistry–An Asian Journal*, vol. 11, no. 23, pp. 3292–3296, 2016.

## Gender and Diversity in Science and Engineering

### Biomedical Humanities

- F. Boem, E. Ratti, M. Andreoletti, and G. Boniolo, "Why genes are like lemons," *Stud. Hist. Philos. Biol. Biomed. Sci.*, vol. 57, pp. 88–95, 2016.
- G. Boniolo, "Public obligation and individual freedom: how to fill the gap? The case of vaccinations," *J. Public Health Res.*, vol. 5, pp. 58–59, 2016.
- G. Boniolo and Sanchini, Eds., "Ethical counselling and medical decision-making in the era of personalized medicine," 1st ed., Heidelberg: Springer, 2016.
- O. Golubnitschaja, B. Baban, G. Boniolo, W. Wang, R. Bubnov, M. Kapalla, K. Krapfenbauer, M. S. Mozaffari, and V. Costigliola, "Medicine in the early twenty-first century: paradigm and anticipation - EPMA position paper 2016," *EPMA J.*, vol. 7, no. 23, 2016.
- G. Boniolo and L. Lanfrancione, "Decomposing biological complexity into a conjunction of theorems. The case of the melanoma network," *Humana.Mente – Journal of Philosophical Studies*, vol. 30, pp. 19–35, 2016.
- A. Linkeviciute, V. Sanchini, K. Dierickx, and G. Boniolo, "Potential pitfalls in the evaluation of ethics consultation: the case of ethical counselling," *Am. J. Bioeth.*, vol. 16, no. 3, pp. 56–57, 2016.

### Gender Stereotypes in Organizations

- P. Brosi, M. Spörrle, I. M. Welpel, and M. E. Heilman, "Expressing pride: effects on perceived agency, communality, and stereotype-based gender disparities," *J. Appl. Psychol.*, vol. 101, no. 9, pp. 1319–1328, 2016.
- P. Brosi, M. Spörrle, I. M. Welpel, and M. E. Heilman, "Willing to lead, not willing to follow: gender-specific inferences from pride expressions," *Acad. Manag. Proc.*, vol. 1, no. 11982, 2016.

### Preventive Pediatrics

- Á. Lendvai, M. J. Deutsch, T. Plösch, and R. Ensenaer, "The peroxisome proliferator-activated receptors under epigenetic control in placental metabolism and fetal development," *Am. J. Physiol. Endocrinol. Metab.*, vol. 310, no. 10, E797–E810, 2016.
- R. Dalla Pozza, R. Pirzer, A. Beyerlein, H. Weberruß, R. Oberhoffer, A. Schmidt-Trucksäss, H. Netz, and N. Haas, "Beyond intima-media-thickness: Analysis of the carotid intima-media-roughness in a paediatric population," *Atherosclerosis* vol. 251, pp. 164–169, 2016.

- J. Müller, J. Meyer, J. Elmenhorst, and R. Oberhoffer, “Body weight and not exercise capacity determines central systolic blood pressure, a surrogate for arterial stiffness, in children and adolescents,” *J. Clin. Hypertens. (Greenwich)*, vol. 18, no. 8, pp. 762–765, 2016.

## Medical Natural Sciences

### Brain Temperature Control of Metabolic Diseases

- C. García-Cacéres, C. Quarta, L. Varela, Y. Gao, T. Gruber, B. Legutko, M. Jastroch, P. Johansson, J. Ninkovic, C. Yi, O. Lê Thúc, K. Szigeti-Buck, W. Cai, C. Meyer, P. Pfluger, A. Fernandez, S. Luquet, S. Woods, I. Torres-Alemán, C.R. Kahn, M. Götz, T. Horvath, and M. Tschöp, “Astrocytic insulin signaling couples brain glucose uptake with nutrient availability,” *Cell*, vol. 166, no. 4, pp. 867–880, 2016.

203

### Clinical Cell Processing and Purification

- P. J. Paszkiewicz, S. P. Fraessle, S. Srivastava, D. Sommermeyer, M. Hudecek, I. Drexler, M. Sadelain, L. Liu, M.C. Jensen, S. R. Riddell, and D.H. Busch, “Targeted antibody-mediated depletion of murine CD19 CAR T cells permanently reverses B cell aplasia,” *J. Clin. Invest.*, vol. 126, no. 11, pp. 4262–4272, 2016.
- M. Nauwerth, C. Stemberger, F. Mohr, B. Weissbrich, M. Schiemann, L. Germeroth, and D. H. Busch, “Flow cytometry-based TCR-ligand Koff-rate assay for fast avidity screening of even very small antigen-specific T cell populations *ex vivo*,” *Cytometry A*, vol. 89, no. 9, pp. 816–825, 2016.
- K. Schober, and D. H. Busch, “A synergistic combination: using RNAseq to decipher both T-cell receptor sequence and transcriptional profile of individual T cells,” *Immunol. Cell Biol.*, vol. 94, pp. 529–530, 2016.
- C. J. Turtle, L. A. Hanafi, C. Berger, T. A. Gooley, S. Cherian, M. Hudecek, D. Sommermeyer, K. Melville, B. Pender, T. M. Budiarto, E. Robinson, N. N. Steevens, C. Chaney, L. Soma, X. Chen, C. Yeung, B. Wood, D. Li, J. Cao, S. Heimfeld, M. C. Jensen, S. R. Riddell, and D. G. Maloney, “CD19 CAR-T cells of defined CD4+:CD8+ composition in adult B cell ALL patients,” *J. Clin. Invest.*, vol. 126, no. 6, pp. 2123–2138, 2016.
- K. Schober, and D. H. Busch, “TIL 2.0: More effective and predictive T-cell products by enrichment for defined antigen specificities,” *Eur. J. Immunol.*, vol. 46, pp. 1335–1339, 2016.
- L. Liu, D. Sommermeyer, A. Cabanov, P. Kosasih, T. Hill, and S. R. Riddell, “Inclusion of Strep-tagII in design of antigen receptors for T-cell immunotherapy,” *Nat. Biotechnol.*, vol. 34, pp. 430–434, 2016.
- D. H. Busch, S. P. Fraessle, D. Sommermeyer, V. R. Buchholz, and S. R. Riddell, “Role of memory T cell subsets for adoptive immunotherapy,” *Semin. Immunol.*, vol. 28, no. 1, pp. 28–34, 2016.
- D. Sommermeyer, M. Hudecek, P. L. Kosasih, T. Gogishvili, D. G. Maloney, T. J. Turtle, and S. R. Riddell, “Chimeric antigen receptor-modified T cells derived from defined CD8+ and CD4+ subsets confer superior antitumor reactivity *in vivo*,” *Leukemia*, vol. 30, pp. 492–500, 2016.

### MicroRNAs Regulating Diabetes and Obesity

- I. Serr, R. W. Fürst, V. B. Ott, M. G. Scherm, A. Nikolaev, F. Gökmen, S. Kälin, S. Zillmer, M. Bunk, B. Weigmann, N. Kunschke, B. Loretz, C. M. Lehr, B. Kirchner, B. Haase, M. W. Pfaffl, A. Waisman, R. A. Willis, A. G. Ziegler, and C. Daniel, “miRNA92a targets KLF2 and PTEN signaling to promote human T follicular helper precursors in T1D islet autoimmunity,” *PNAS* 2016, vol. 113, no.43, pp. E6659–E6668, 2016.
- Y. J. Wang, M. L. Golson, J. Schug, D. Traum, C. Liu, K. Vivek, C. Dorrell, A. Najj, A. C. Powers, K. M. Chang, M. Grompe, and K. H. Kaestner, “Single-cell mass cytometry analysis of the human endocrine pancreas,” *Cell Metab.*, vol. 24, no. 4, pp. 616–626, 2016.

### Proteases in the Brain

- R. O. Alabi, K. Glomski, C. Haxaire, G. Weskamp, S. Monette, and C. P. Blobel, “ADAM10-dependent signaling through Notch1 and Notch4 controls development of organ-specific vascular beds,” *Circ. Res.*, vol. 119, no. 4, pp. 519–531, 2016.
- S. A. Müller, S. D. Scilabra, and S. F. Lichtenthaler, “Proteomic substrate identification for membrane proteases in the brain,” *Front. Mol. Neurosci.*, vol. 9, no. 96, 2016.
- X. P. Qing, L. Rogers, A. Mortha, Y. Lavin, P. Redecha, P. D. Issuree, T. Maretzky, M. Merad, D. R. Mcllwain, T. W. Mak, C. M. Overall, C. P. Blobel, and J. E. Salmon, “iRhom2 regulates CSF1R cell surface expression and non-steady state myelopoiesis in mice,” *Eur. J. Immunol.*, vol. 46, no. 12, pp. 2737–2748, 2016.

- P. H. Kuhn, A. V. Colombo, B. Schusser, D. Dreymueller, S. Wetzel, U. Schepers, J. Herber, A. Ludwig, E. Kremmer, D. Montag, U. Müller, M. Schweizer, P. Saftig, S. Bräse, and S. F. Lichtenthaler, "Systematic substrate identification indicates a central role for the metalloprotease ADAM10 in axon targeting and synapse function," *eLife*, vol. 5, no. e12748, 2016.
- D. Goricanec, R. Stehle, P. Egloff, S. Grigoriu, A. Plücker, G. Wagner, and F. Hagn, "Conformational dynamics of a G-protein  $\alpha$  subunit is tightly regulated by nucleotide binding," *Proc. Natl. Acad. Sci. USA*, vol. 113, no. 26, pp. 3629–3638, 2016.
- M. Pignoni, J. Wangren, P. H. Kuhn, K. M. Munro, J. M. Gunnensen, H. Takeshima, R. Feederle, I. Voytyuk, B. De Strooper, M. D. Lévassieur, B. J. Hrupka, S. A. Müller, and S. F. Lichtenthaler, "Seizure protein 6 and its homolog seizure 6-like protein are physiological substrates of BACE1 in neurons," *Mol. Neurodegen.*, vol. 11, no. 67, 2016.

### Proteomics

- P.-H. Kuhn, A. V. Colombo, B. Schusser, D. Dreymueller, S. Wetzel, U. Schepers, J. Herber, A. Ludwig, E. Kremmer, D. Montag, U. Müller, M. Schweizer, P. Saftig, S. Bräse, and S. F. Lichtenthaler, "Systematic substrate identification indicates a central role for the metalloprotease ADAM10 in axon targeting and synapse function," *eLife*, vol. 5, no. e12748, 2016.
- B. M. Schwenk, H. Hartmann, A. Serdaroğlu, M. H. Schludi, D. Hornburg, F. Meissner, D. Orozco, A. Colombo, S. Tahirovic, M. Michaelsen, F. Schreiber, S. Haupt, M. Peitz, O. Brustle, C. Kupper, T. Klopstock, M. Otto, A. C. Ludolph, T. Arzberger, P. H. Kuhn, and D. Edbauer, "TDP-43 loss of function inhibits endosomal trafficking and alters trophic signaling in neurons," *EMBO J.*, vol. 35, no. 21, pp. 2350–2370, 2016.
- A. Serdaroğlu, S. A. Müller, U. Schepers, S. Bräse, W. Weichert, S. F. Lichtenthaler, and P. H. Kuhn, "An optimised version of the secretome protein enrichment with click sugars (SPECS) method leads to enhanced coverage of the secretome," *Proteomics*, no. 1600423, 2016.
- M. Wagner, M. Oelsner, A. Moore, F. Gotte, P. H. Kuhn, T. Haferlach, M. Fiegl, C. Bogner, E. J. Baxter, C. Peschel, G. A. Follows, and I. Ringshausen, "Integration of innate into adaptive immune responses in ZAP-70-positive chronic lymphocytic leukemia," *Blood*, vol. 127, no. 4, pp. 436–448, 2016.
- B. Kretner, J. Trambauer, A. Fukumori, J. Mielke, P. H. Kuhn, E. Kremmer, A. Giese, S. F. Lichtenthaler, C. Haass, T. Arzberger, and H. Steiner, "Generation and deposition of A $\beta$ 43 by the virtually inactive presenilin-1 L435F mutant contradicts the presenilin loss-of-function hypothesis of Alzheimer's disease," *EMBO Mol. Med.*, vol. 8, no. 5, pp. 458–465, 2016.
- M. Pignoni, J. Wangren, P. H. Kuhn, K. M. Munro, J. M. Gunnensen, H. Takeshima, R. Feederle, I. Voytyuk, B. De Strooper, M. D. Lévassieur, B. J. Hrupka, S. A. Müller, and S. F. Lichtenthaler, "Seizure protein 6 and its homolog seizure 6-like protein are physiological substrates of BACE1 in neurons," *Mol. Neurodegener.*, vol. 11, no. 1, pp. 67–84, 2016.
- C. Hofling, M. Morawski, U. Zeitschel, E. R. Zanier, K. Moschke, A. Serdaroğlu, F. Canneva, S. von Horsten, M. G. De Simoni, G. Forloni, C. Jäger, E. Kremmer, S. Rossner, S. F. Lichtenthaler, and P. H. Kuhn, "Differential transgene expression patterns in Alzheimer mouse models revealed by novel human amyloid precursor protein-specific antibodies," *Aging Cell*, vol. 15, no. 5, pp. 953–963, 2016.

### Viral Hepatitis

- D. L. Hedegaard, D. C. Tully, I. A. Rowe, G. M. Reynolds, K. Hu, C. Davis, A. Wilhem, C. B. Ogilvie, K. A. Power, A. Tarr, D. Kelly, T. M. Allen, P. Balfe, and J. A. McKeating, "High resolution sequencing of hepatitis C virus reveals limited intrahepatic compartmentalization during late stage liver disease," *J. Hepatol.*, vol. 66, no. 1, pp. 28–38, 2016.
- M. D. Appelman, A. Chakraborty, U. Protzer, J. A. McKeating, and S. F. J. van de Graaf, "N-glycosylation of the Na<sup>+</sup>-taurocholate Co-transporting polypeptide (NTCP) determines its trafficking and stability and is required for hepatitis type B virus entry," *Plos ONE*, vol. 12, no. 1, e0170419, 2017, accepted in 2016.
- M. Farquhar, I. Humphreys, S. A. Rudge, G. Wilson, B. Bhattacharya, M. Ciaccia, K. Hu, Q. Zhang, L. Mailly, G. Reynolds, M. Ashcroft, P. Balfe, T. F. Baumert, S. Roessler, M. J. O. Wakelam, and J. A. McKeating, "Autotaxin-lysophosphatidic acid receptor signalling regulates hepatitis C virus replication," *J. Hepatol.*, 2017, accepted in 2016.

- Y. Xia, D. Stadler, J. Lucifora, F. Reisinger, D. Webb, M. Hösel, T. Michler, K. Wisskirchen, X. Cheng, K. Zhang, W.-M. Chao, J. Wettengel, A. Malo, F. Bohne, D. Hoffmann, F. Eyer, R. Thimme, W. E. Thasler, M. Heikenwalder, and U. Protzer, “Interferon- $\gamma$  and tumor necrosis factor- $\alpha$  produced by T cells reduce the HBV persistence form, cccDNA, without Cytolysis,” *Gastroenterology*, vol. 150, no. 1, pp. 194–202, 2016.
- T. Michler, S. Große, S. Mockenhaupt, N. Röder, F. Stückler, B. Knapp, C. Ko, M. Heikenwalder, U. Protzer, and D. Grimm, “Blocking sense strand activity improves potency, safety and specificity of anti-hepatitis B virus short hairpin RNA,” *EMBO Mol. Med.*, vol. 8, no. 9, pp. 1082–1098, 2016.
- Y. Xia, A. Carpentier, X. Cheng, P. D. Block, Y. Zhao, Z. Zhang, U. Protzer, and T. Jake Liang, “Human stem cell-derived hepatocytes as a model for hepatitis B virus infection, spreading and virus-host interactions,” *J. Hepatol.*, vol. 66, no. 3, pp.494–503, 2016.
- O. Mayorga, S. Bühler, V. K. Jaeger, S. Bally, C. Hatz, G. Frösner, U. Protzer, P. Van Damme, M. Egger, and C. Herzog, “Single dose hepatitis A immunisation: 7.5 year observational pilot study in Nicaraguan children to assess protective effectiveness and humoral immune memory response,” *J. Infect. Dis.*, vol. 2014, no. 10, pp. 1498–1506, 2016.
- J. Lehmann, J. Vomacka, K. Esser, M. Nodwell, K. Kolbe, P. Rämer, U. Protzer, N. Reiling, and S. A. Sieber, “Human lysosomal acid lipase inhibitor Ialostatat impairs Mycobacterium tuberculosis growth by targeting bacterial hydrolases,” *Med. Chem. Comm.*, vol. 7, no. 9, pp. 1797–1801, 2016.
- M. K. Thomsen, R. Nandakumar, D. Stadler, A. Malo, R. M. Valls, F. Wang, L. S. Reinert, F. Dagnaes-Hansen, A. K. Hollensen, J. G. Mikkelsen, U. Protzer, and S. R. Paludan, “Lack of immunological DNA sensing in hepatocytes facilitates hepatitis B virus infection,” *Hepatology*, vol. 64, no. 3, pp. 746–759, 2016.
- N. Körber, U. Behrends, A. Hapfelmeier, U. Protzer, and T. Bauer, “Validation of an IFN $\gamma$ /IL2 FluoroSpot assay for clinical trial monitoring,” *J. Transl. Med.*, vol. 14, no. 175, 2016.
- B. Saugel, J. Jakobus, W. Huber, D. Hoffmann, K. Holzapfel, U. Protzer, R. M. Schmid, and A. Umgelter, “Herpes simplex virus in bronchoalveolar lavage fluid of medical intensive care unit patients: Association with lung injury and outcome,” *J. Crit. Care*, vol. 32, pp. 138–144, 2016.
- S. Backes, C. Jäger, C. Dembek, T. Bauer, A. Dislers, G. Mutwiri, D. Busch, L. Babiuk, G. Gasteiger, and U. Protzer, “Protein-prime/modified vaccinia virus Ankara vector-boost vaccination overcomes tolerance in high-antigenemic HBV-transgenic mice,” *Vaccine*, vol. 34, no. 7, pp. 923–932, 2016.
- L. W. Meredith, K. Hu, X. Cheng, C. R. Howard, T. F. Baumert, P. Balfe, K. F. van de Graaf, U. Protzer, and J. A. McKeating, “Lentiviral hepatitis B pseudotype entry requires NTCP and additional hepatocyte-specific factors,” *J. Gen. Virol.*, vol. 97, no. 1, pp. 121–127, 2016.
- G. A. Sautto, K. Wisskirchen, N. Clementi, M. Castelli, R. A. Diotti, J. Graf, M. Clementi, R. Burioni, U. Protzer, N. Mancini, “Chimeric antigen receptor (CAR)-engineered T cells redirected against hepatitis C virus (HCV) E2 glycoprotein,” *Gut*, vol. 65, no. 3, pp. 512–523, 2016.
- N. F. Fletcher, P. Balfe, and J. A. McKeating, “TNF superfamily members promote Hepatitis C virus entry through NF- $\kappa$ B and myosin light chain kinase activation,” *J. Gen. Virol.*, 2017, accepted in 2016.
- D. Gonçalves-Carneiro, J. A. McKeating, and D. Bailey, “The measles virus receptor SLAMF1 can mediate particle endocytosis,” *J. Gen. Virol.*, vol. 91, no. 7, 2017, accepted in 2016.
- Y. H. Zhang, Y. Zhao, U. Rajapaksa, T. Lawrence, Y.-C. Peng, J. Liu, J. Xu, K. Hu, L. Qin, H. Sun, H.-P. Yan, S. Rowland-Jones, R. Thimme, J. A. McKeating, and T. Dong, “A comprehensive analysis of HCV specific immune responses in a HIV co-infected plasma donor cohort uncovers a role for CD4+ T cells to control HCV replication and liver disease progression,” *Plos ONE*, vol. 11, no. 7, e158037, 2016.
- E. R. Verrier, C. C. Colpitts, L. Zona, C. Bach, L. Heydmann, F. Xiao, C. Thumann, C. Schuster, C. Sureau, J. A. McKeating, Y. Hoshida, M. B. Zeisel, and T. F. Baumert, “Solute carrier NTCP regulates expression of innate antiviral immune responses targeting viral cell entry into hepatocytes,” *Cell Rep.*, vol. 17, no. 5, pp. 1357–1368, 2016.
- I. Desombere, S. Fafi-Kremer, F. Van Houtte, P. Pessaux, A. Farhoudi, L. Heydmann, L. Verhoye, S. Beattie, J. A. McKeating, G. Leroux-Roels, T. F. Baumert, A. H. Patel, and P. Meuleman, “Monoclonal anti-envelope antibody AP33 protects against an in vivo hepatitis C virus quasispecies challenge,” *Hepatology*, vol. 63, no. 4, pp. 1120–1134, 2016.

- D. C. Tully, S. Hjerrild, P. D. Leutscher, S. G. Renvillard, C. B. Ogilvie, D. J. Bean, P. Videbeck, T. D. Allen, J. A. McKeating, and N. F. Fletcher, “Deep sequencing of hepatitis C virus reveals potential compartmentalization in cerebrospinal fluid from cognitively impaired patients,” *Liver Int.*, vol. 36, no. 10, pp. 1418–1424, 2016.
- I. A. Rowe, D. Tulley, M. J. Armstrong, R. Parker, K. Guo, D. Barton, G. D. Morse, C. S. Venuto, C. B. Ogilvie, D. L. Hedegaard, J. F. McKelvy, F. Wong-Staal, T. Allen, P. Balfe, J. A. McKeating, and D. Mutimer, “Effect of scavenger receptor BI antagonist ITX5061 on hepatitis C virus infection of the liver after transplantation,” *Liver Transpl.*, vol. 22, no. 3, pp. 287–297, 2016.
- U. Protzer, and P. Knolle, “‘To Be or Not to Be’: Immune Tolerance in Chronic Hepatitis B,” *Gastroenterol.*, vol. 151, no. 5, pp. 805–806, 2016.
- J. Lucifora, and U. Protzer, “Attacking hepatitis B virus cccDNA – The holy grail to hepatitis B cure,” *J. Hepatol.*, vol. 64, no. 1, pp. S41–S48, 2016.

## Surface, Interface, Nano- and Quantum Science

### Collective Quantum Dynamics

- K. Agarwal, E. Altman, E. Demler, S. Gopalakrishnan, D. A. Huse, and M. Knap, “Rare region effects and dynamics near the many-body localization transition,” *Ann. Phys.*, 2017, accepted in 2016.
- P. Bordia, H. Lüschen, U. Schneider, M. Knap, and I. Bloch “Periodically driving a many-body localized quantum system,” *Nat. Phys.*, 2017, accepted in 2016.
- M. Cetina, M. Jag, R. S. Lous, I. Fritsche, J. T. M. Walraven, R. Grimm, J. Levinsen, M. M. Parish, R. Schmidt, M. Knap, and E. Demler, “Ultrafast many-body interferometry of impurities coupled to a Fermi sea,” *Science*, vol. 354, no. 6308, pp. 96–99, 2016.
- S. Gopalakrishnan, M. Knap, and E. Demler, “Regimes of heating and dynamical response in driven many-body localized systems,” *Phys. Rev. B*, vol. 94, no. 9, p. 094201, 2016.
- M. Knap, M. Babadi, G. Refael, I. Martin, and E. Demler, “Dynamical Cooper pairing in non-equilibrium electron-phonon systems,” *Phys. Rev. B*, vol. 94, no. 7, p. 214504, 2016.
- D. S. Wild, S. Gopalakrishnan, M. Knap, N. Y. Yao, and M. D. Lukin, “Adiabatic quantum search in open systems,” *Phys. Rev. Lett.*, vol. 117, no. 15, p. 150501, 2016.
- S. Gopalakrishnan, K. Agarwal, E. Demler, D. A. Huse, and M. Knap, “Griffiths effects and slow dynamics in nearly many-body localized systems,” *Phys. Rev. B*, vol. 93, no. 13, p. 134206, 2016.

### Functional Interfaces

- Y. He, M. Garnica, J. Duce, F. Bischoff, M. Bocquet, M. Batzill, W. Auwärter, and J. V. Barth, “Fusing tetrapyrroles to graphene edges by surface-assisted covalent coupling,” *Nat. Chem.*, vol. 9, pp. 33–38, 2017, accepted in 2016.
- M. Garnica, M. Schwarz, J. Duce, Y. He, F. Bischoff, J. V. Barth, W. Auwärter, and D. Stradi, “Comparative study of the interfaces of graphene and hexagonal boron nitride with silver,” *Phys. Rev. B*, vol. 94, no. 15, p. 155431, 2016.
- F. Bischoff, Y. He, K. Seufert, D. Stassen, D. Bonifazi, J.V. Barth, and W. Auwärter, “Tailoring large pores of porphyrin networks on Ag(111) by metal–organic coordination,” *Chemistry – A European Journal*, vol. 22, no. 43, pp. 15298–15306, 2016.

### Metal-Organic Superlattices of Quantum Magnets

- R. Hellwig, T. Paintner, Z. Chen, M. Ruben, A. P. Seitsonen, F. Klappenberger, H. Brune, and J. V. Barth, “Epitaxy-induced assembly and enantiomeric switching of an on-surface formed dinuclear organocobalt complex,” *ACS Nano*, vol. 11, pp. 1347–1359, 2017, accepted in 2016.
- F. Donati, S. Rusponi, S. Stepanow, C. Wäckerlin, A. Singha, L. Persichetti, R. Baltic, K. Diller, F. Patthey, E. Fernandes, H. Brune, et al., “Magnetic remanence in single atoms,” *Science*, vol. 352, no. 6283, pp. 318–321, 2016.
- R. Baltic, M. Pivetta, F. Donati, C. Wäckerlin, A. Singha, J. Dreiser, S. Rusponi, and H. Brune, “Superlattice of single atom magnets on graphene,” *Nano Lett.*, vol. 16, no. 12, pp. 7610–7615, 2016.



## Nanophotonics and Quantum Optics

- M. Kaniber, K. Schraml, A. Regler, J. Bartl, G. Glashagen, F. Flassig, J. Wierzbowski, and J. Finley, "Surface plasmon resonance spectroscopy of single bowtie nano-antennas using a differential reflectivity method," *Sci. Rep.*, vol. 6, no. 23203, 2016.
- K. Schraml, A. Regler, J. Bartl, G. Glashagen, J. Wierzbowski, J. Finley, and M. Kaniber, "Metamorphic plasmonic nanoantennas for self-enhanced nonlinear light generation," *OPTICA*, vol. 3, no. 12, pp. 1453–1459, 2016.
- A. Regler, K. Schraml, A. Lyamkina, M. Spiegl, K. Müller, J. Vuckovic, J. Finley, and M. Kaniber, "Emission redistribution from a quantum dot-bowtie nanoantenna," *J. Nanophoton.* vol. 10, no. 3, 033509, 2016.
- A. Lyamkina, K. Schraml, A. Regler, M. Schalk, A. Bakarov, A. Toropov, S. Moshenko, and M. Kaniber, "Monolithically integrated single quantum dots coupled to bowtie nanoantennas," *Opt. Express.*, vol. 24, no. 26, 2016.

207

## Semiconductor Nanowires

- A. W. Holleitner, "Ultrafast optoelectronics in nanowire-based circuits," in *IEEE Photon Soc. Summ. Top Meet. Series*, 2016, pp. 41.
- B. Loitsch, M. Müller, J. Winnerl, P. Veit, D. Rudolph, G. Abstreiter, J. J. Finley, F. Bertram, J. Christen, and G. Koblmüller, "Microscopic nature of crystal phase quantum dots in ultrathin GaAs nanowires by nanoscale luminescence characterization," *New J. Phys.*, vol. 18, pp. 063009, 2016.
- T. Stettner, P. Zimmermann, B. Loitsch, M. Döbinger, A. Regler, B. Mayer, J. Winnerl, S. Matich, H. Riedl, M. Kaniber, G. Abstreiter, G. Koblmüller, and J. J. Finley, "Coaxial GaAs-AlGaAs core-multi-shell nanowire lasers with epitaxial gain control," *Appl. Phys. Lett.*, vol. 108, pp. 011108, 2016.
- S. Karg, V. Schaller, A. Gaul, K. Moselund, H. Schmid, B. Gotsmann, J. Gooth, and H. Riel, "Ballistic transport and high thermopower in one-dimensional InAs nanowires," in *Solid State Dev. Res. Conf. (ESSDERC)*, Lausanne, Switzerland, 2016.
- B. Loitsch, N. Jeon, M. Döbinger, J. Winnerl, E. Parzinger, S. Matich, U. Wurstbauer, H. Riedl, G. Abstreiter, J. J. Finley, L. J. Lauhon, and G. Koblmüller, "Suppression of alloy fluctuations in GaAs-AlGaAs core-shell nanowires," *Appl. Phys. Lett.*, vol. 109, p. 093105, 2016.
- M. Speckbacher, J. Treu, T. J. Whittles, W. M. Linhart, X. Xu, K. Saller, V. R. Dhanak, G. Abstreiter, J. J. Finley, T. D. Veal, and G. Koblmüller, "Direct measurements of fermi level pinning at the surface of intrinsically N-type InGaAs nanowires," *Nano Lett.*, vol. 16, pp. 5135, 2016.
- J. Treu, M. Speckbacher, K. Saller, S. Morkötter, M. Döbinger, X. Xu, H. Riedl, G. Abstreiter, J. J. Finley, and G. Koblmüller, "Widely tunable alloy composition and crystal structure in catalyst-free InGaAs nanowire arrays grown by selective area molecular beam epitaxy," *Appl. Phys. Lett.*, vol. 108, pp. 053110, 2016.
- B. Mayer, L. Janker, D. Rudolph, B. Loitsch, T. Kostenbader, G. Abstreiter, G. Koblmüller, and J. J. Finley, "Continuous wave lasing from individual GaAs-AlGaAs core-shell nanowires," *Appl. Phys. Lett.*, vol. 108, pp. 071107, 2016.
- B. Mayer, L. Janker, B. Loitsch, J. Treu, T. Kostenbader, S. Lichtmanecker, T. Reichert, S. Morkötter, M. Kaniber, G. Abstreiter, C. Gies, G. Koblmüller, and J. J. Finley, "Monolithically integrated high-beta nanowire lasers on silicon," *Nano Lett.*, vol. 16, pp. 152, 2016.
- J. B. Kinzel, F. J. Schüle, M. Weiß, L. Janker, D. D. Bühler, M. Heigl, D. Rudolph, S. Morkötter, M. Döbinger, M. Bichler, G. Abstreiter, J. J. Finley, A. Wixforth, G. Koblmüller, and H. J. Krenner, "The native material limit of electron and hole mobilities in semiconductor nanowires," *ACS Nano*, vol. 10, pp. 4942, 2016.

## Theory of Complex Quantum Systems

- X. Ni, F. Pastawski, B. Yoshida, and R. König, "Preparing topologically ordered states by Hamiltonian interpolation," *New J. Phys.*, vol. 18, no. 093027, 2016.
- R. König, and V. B. Scholz, "Matrix product approximations to multipoint functions in two-dimensional conformal field theory," *Phys. Rev. Lett.*, vol. 117, no. 121601, 2016.
- T. Cooney, M. Mosonyi, and M. M. Wilde, "Strong converse exponents for a quantum channel discrimination problem and quantum-feedback-assisted communication," *Commun. Math. Phys.*, vol. 344, no. 3, pp. 797–829, 2016.
- M. Beverland, O. Buerschaper, R. Koenig, F. Pastawski, J. Preskill and S. Sijher, "Protected gates for topological quantum field theories," *J. Math. Phys.*, vol. 57, no. 022201, 2016.



## Facts and Figures

# Where do the TUM-IAS Fellows come from?

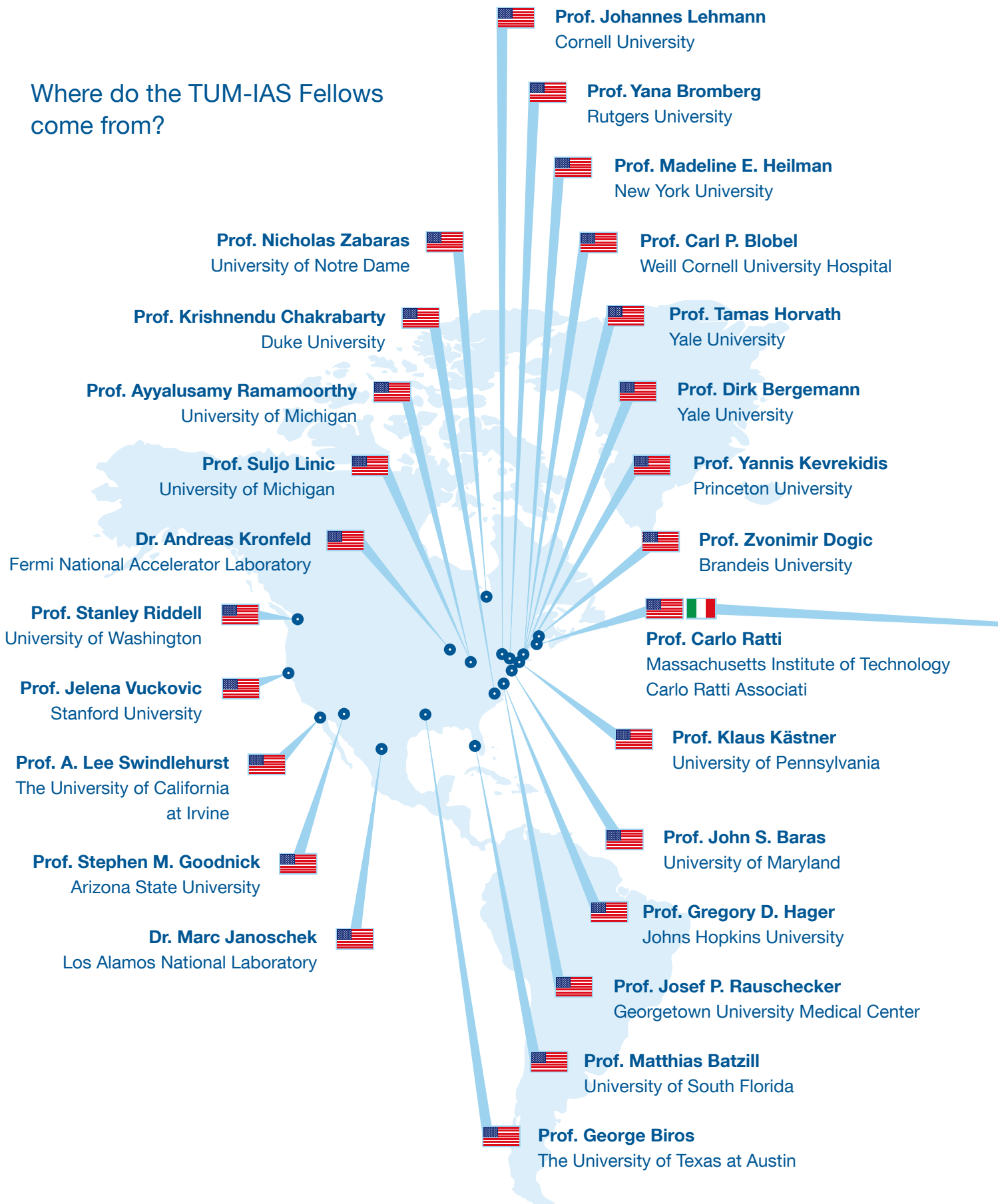



## Fellow Distribution

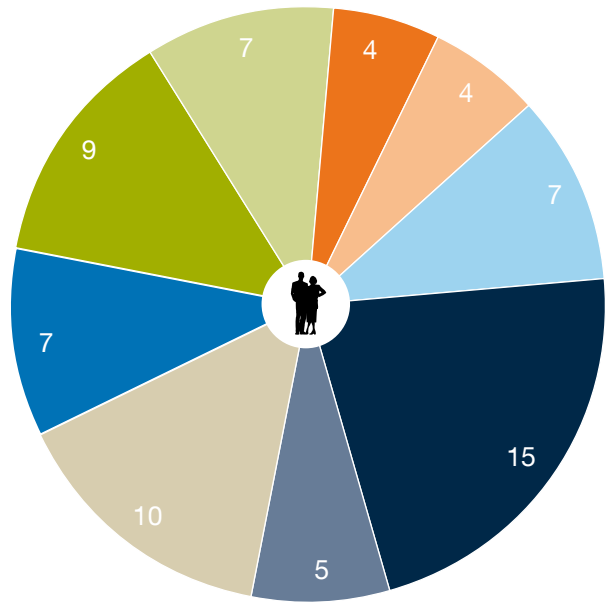
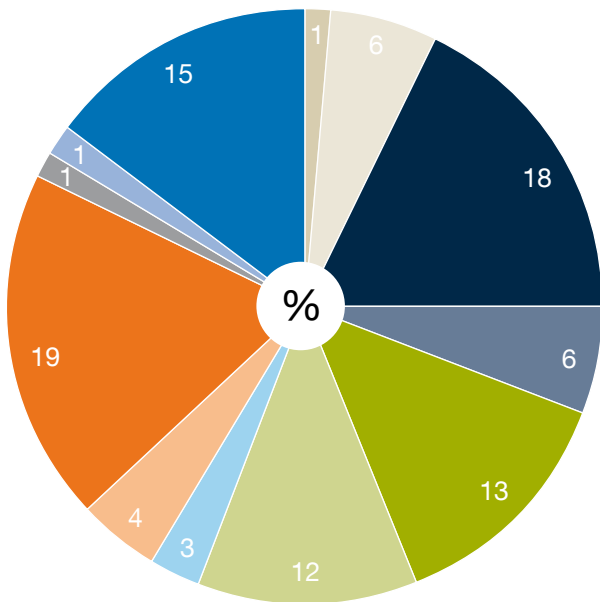

- |   |   |   |   |
|---|---|---|---|
|  | Architecture                                      |  | Advanced Computation and Modeling                     |
|  | Center of Life and Food Sciences Weihenstephan    |  | Bio-Engineering and Imaging                           |
|  | Chemistry   |  | Medical Natural Sciences                              |
|  | Civil, Geo and Environmental Engineering          |  | Communication and Information                         |
|  | Electrical Engineering and Information Technology |  | Control Theory, Systems Engineering and Robotics      |
|  | Informatics                                       |  | Environmental and Earth Sciences, Building Technology |
|  | Mathematics                                       |  | Fundamental Natural and Life Sciences                 |
|  | Mechanical Engineering                            |  | Gender and Diversity in Science and Engineering       |
|  | Physics   |  | Surface, Interface, Nano- and Quantum Science         |
|  | Sports and Health Sciences                        |   |   |
|  | TUM School of Management                          |   |   |
|  | TUM School of Medicine                            |   |   |

This section provides a brief overview of the financial data of the TUM-IAS. The expenditures are covered by the “third funding line” of the German Excellence Initiative, as well as by the European Union Seventh Framework Program (Marie Curie COFUND) and by the TÜV SÜD Foundation.

This chart illustrates the expenditure in 2016 for each Fellowship category. Most dominant in terms of costs – with 41 percent of the total expenditure – are the Rudolf Mößbauer Tenure Track Professorships, for the second year in a row. This is quite remarkable, as the program was established in 2013, making it one of our newest. Our 2016 results underscore the significant investment the TUM-IAS is making in supporting young talent. The program is devoted to the funding of outstanding, high-potential early career scientists who have already achieved a major scientific or technological breakthrough, and who also have the ambition of developing a new field of endeavor when joining TUM (as a Tenure Track Assistant Professor).

The Hans Fischer Senior Fellowship comes in second in terms of cost, and comprises 28 percent of the total expenditure for our Fellowship programs. The Hans Fischer Senior Fellowships represent an integral part of TUM’s focus on internationalization, and are immensely valuable in terms of the exchange of complementary expertise and the grooming of emerging fields. The expenditure for this Fellowship category increased about 13 percent in comparison to 2015.

Whereas the Carl von Linde Senior Fellowship category decreased in regards to expenditure in 2015 when compared with 2014, in 2016, it increased again. This reflects the fact that from 2013 onward, one Carl von Linde Senior Fellow has been appointed each year. Meanwhile, the Rudolf Diesel Industry Fellowship expenditures decreased dramatically in comparison to 2015, on one hand because doctoral candidates are no longer financed in this category, and on the other hand due to the fact that in the 2015 call, no Fellows were appointed in this category.

Expenditure per Fellowship Category in 2016

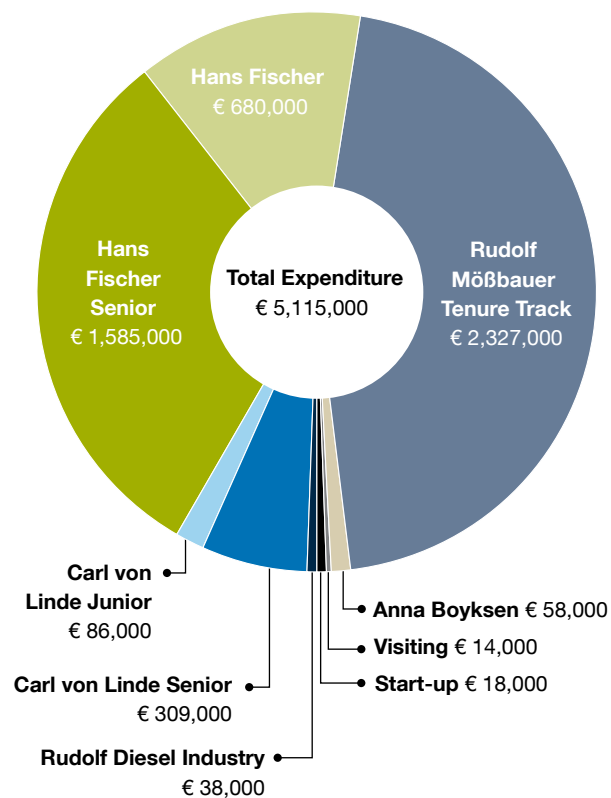

Expenditure for the Hans Fischer Fellowship category increased slightly: As another relatively new program in our lineup that we launched in 2013, this Fellowship has now become an integral part of our range of Fellowships.

Finally: the Anna Boyksen Fellowship category, the very newest addition to the TUM-IAS Fellowship roster when it was established in 2014, is still the Fellowship with the most modest budget among all others. Nevertheless, expenditures for this program were four times higher in 2016 than in the previous year, reflecting the increasing importance being given to gender and diversity-related issues in society and the engineering and natural sciences.



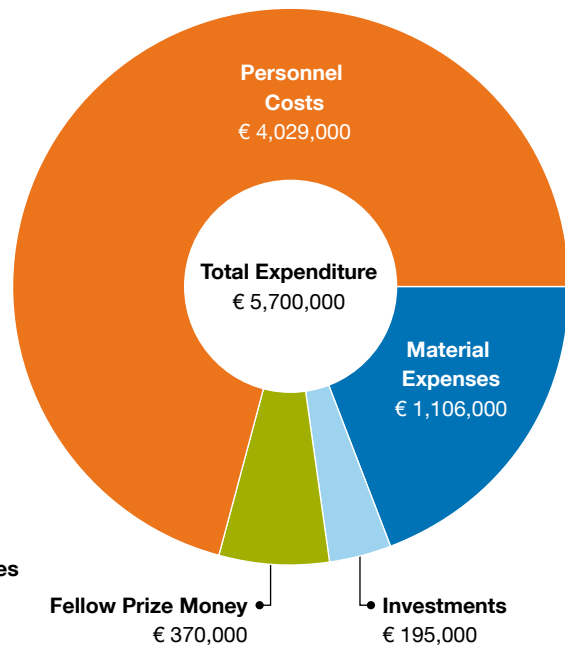
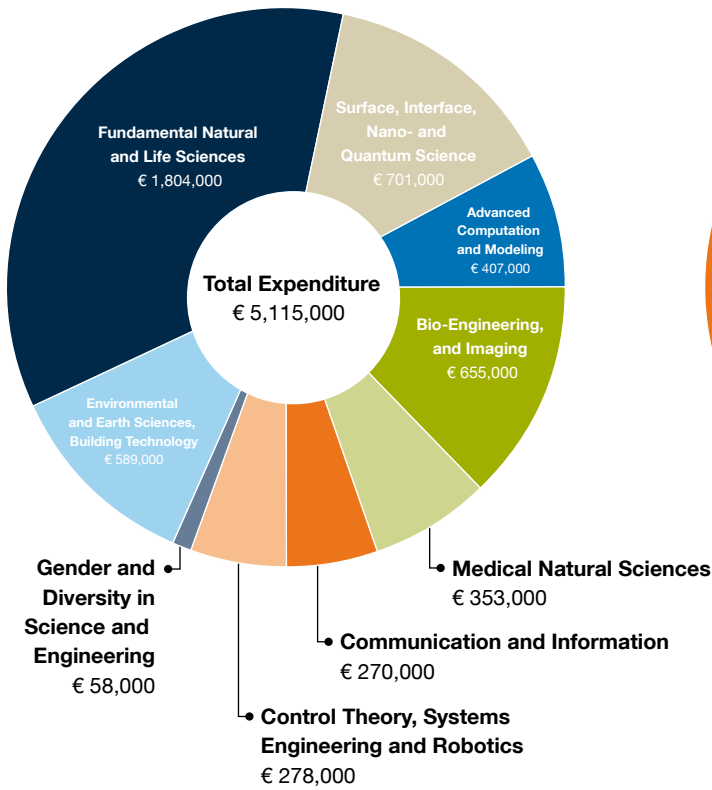

This chart shows the TUM-IAS Fellowship expenditures grouped by scientific fields at TUM, along with expenditures from the Start-up and Visiting Fellowship programs, which are also grouped according to scientific fields. Interdisciplinary projects were classified according to their most dominant field. Expenditure per main scientific field reflects the distribution of Fellows according to the same divisions (see page 213 “Fellow Distribution”). The research area with the highest expenditures was Fundamental Natural and Life Sciences, reflecting a high number of Rudolf Mößbauer Tenure Track Professors and Hans Fischer Senior Fellows working in this field.

On this chart, total TUM-IAS expenditure is displayed, including Fellowships, Start-up funding, Visiting Fellowships, events, and management. The total expenditure increased in comparison to 2015 (5,085,000 Euro) reflecting mainly the increase in the number of Rudolf Mößbauer Tenure Track Professors. The difference between the total expenditures per Fellowship category / Research Area and the total expenditure in 2016 amounts to management and event expenses: 468,200 Euro Management (of which 359,700 Euro are expenses related to personnel) and 120,000 Euro for event-related expenses.

A

Advanced Stability Analysis 66  
Automated Controller Synthesis 94

B

Baras 90  
Batzill 166  
Bergemann 84  
Biochemistry 130  
Biologically Inspired Material Science 122  
Biomedical Humanities 144  
Biomolecular Design 118  
Biros 60  
Blobel 152  
Boekhoven 112  
Boniolo 144  
Brain Temperature Control of  
Metabolic Diseases 154  
Bromberg 114  
Brune 178  
Buss 92

C

Camilloni 116  
Cellular Protein Biochemistry 124  
Chemical Catalysis, Photo-catalysis and  
Electro-catalysis 140  
Chen 100  
Climate Flows 110  
Clinical Cell Processing and Purification 164  
Collective Quantum Dynamics 168  
Complex Systems Modeling & Computation 62  
Computational Mechanics:  
Geometry and Numerical Simulation 64  
Control and Robotics 92

D

De Rijcke 146  
Dietz 118  
Dogic 122

E

Electrochemical Interfaces in Batteries 172  
Ensenauer 148  
Environmental Sensing and Modeling 100  
Exploiting Antenna Arrays for Next-Generation  
Wireless Communications Systems 86

F

Feige 124  
Functional Interfaces 166  
Functional Metagenomics 114

G

Gender and Diversity in Science  
and Engineering 146  
Gender Stereotypes in Organizations 150  
Global Change 106

H

Hager 72  
Hagn 126  
Heilman 150  
Heller 96  
High-Performance Computing (HPC) 60  
High-Resolution Gravity Modeling 102  
Hirt 102  
Ho 74  
Horvath 154  
Human-Machine Collaborative Systems 72

I

Image-based Biomedical Modeling 78  
Information, Interaction and Mechanism Design 84  
Integrative Structural Biology 116

J

Johannes 128

- K**  
Kästner 156  
Kessler 130  
Kevrekidis 62  
Khan 104  
Knap 168  
Koehler 76  
König 170  
Kronfeld 132  
Kuhn 158
- L**  
Lamp 172  
Lang 136  
Lasserre 138  
Linic 140
- M**  
McKeating 160  
Menze 78  
Menzel 106  
Metal-Organic Superlattices of  
Quantum Magnets 178  
Microfluidic Design Automation 74  
MicroRNAs Regulating Diabetes and Obesity 156  
Modeling Spatial Mobility 108  
Moeckel 108  
Morgan 76  
Muscholl 94
- N**  
Nanophotonics and Quantum Optics 176  
Networked Cyber-Physical Systems 90  
Neuroimaging 80
- O**  
Optimal Control and Medical Imaging 82
- P**  
Pfeiffer 76  
Phase-Contrast Computed Tomography 76  
Physics with Effective Field Theories 132  
Population Epigenetics and Epigenomics 128  
Preventive Pediatrics 148  
Proteases in the Brain 152  
Protein Misfolding and Amyloid Diseases 142  
Proteomics 158
- R**  
Ramamoorthy 142  
Ratti 110  
Rauschecker 80  
Reali 64  
Riddell 164  
Riel 174
- S**  
Safe Adaptive Dependable  
Aerospace Systems (SADAS) 96  
Schuermans 66  
Semiconductor Nanowires 174  
Spiegelberg 96  
Sterile Neutrino and Dark Matter 138  
Structural Membrane Biochemistry 126  
Sugny 82  
Supramolecular Chemistry 112  
Sustainable Water Cycles for  
Cities of the Future 104  
Swindlehurst 86  
Synthetic Biochemistry 136
- T**  
Theory of Complex Quantum Systems 170
- U**  
Uncertainty Quantification and  
Predictive Modeling 70
- V**  
Viral Hepatitis 160  
Vuckovic 176
- Z**  
Zabaras 70

Cover and inside cover: C. Hirt, S. J. Claessens, T. Fecher, M. Kuhn, R. Pail, and M. Rexer, “New ultrahigh-resolution picture of Earth’s gravity field,” *Geophysical Research Letters*, vol. 40, no. 16, pp. 4279–4283, 2013.

4, 6, 13 (Rank, Steinberger, Höchtl, Fischer), 21, 23, 40, 43, 58, 94, 102 (Hirt), 106 (Menzel), 128, 135, 138, 150, 152, 163, 164: Astrid Eckert.

10, 13 (Sturm, Schmid, Strücker), 49–50, 52, 54–55, 64, 66, 76 (Koehler, Pfeiffer), 78, 80, 86, 92 (Buss), 100 (Chen), 108, 112, 114, 116, 122, 126, 144, 146, 154, 158, 166, 168 (Knap), 170, 172, 181: Andreas Heddergott.

11 (Santos Kühn), 118 (Dietz): Astrid Eckert/Andreas Heddergott.

13 (Pettinato): Blende11 Fotografen.

25: Sungmin Hwang.

30, 34: Julie Rousset.

32–33, 42: Adina von Malm.

35 (upper): André Borrmann/TUM.

35 (bottom left and center right): NASA.

35 (bottom right): Hohmann/Dietz, Nano Initiative Munich.

46: Dietmar W. Hutmacher/Queensland University of Technology.

65 (figure 1): Simulation by Chair for Computation in Engineering (TUM); (figure 2): CAD model from GrabCAD, designed by Sean Morrissey; Simulation by Chair for Computation in Engineering (TUM).

72 (figure 1): C. Rupprecht, C. Lea, F. Tombari, N. Navab, and G. D. Hager, “Sensor substitution for video-based action recognition,” in *Proceedings of the IEEE/RSJ International Conference on Intelligent Robots and Systems (IROS)*, Daejeon, Korea, 2016, pp. 5230 – 5237; (figure 2): R. DiPietro, C. Lea, A. Malpani,

N. Ahmidi, S. S. Vedula, G. I. Lee, M. R. Lee, and G. D. Hager, “Recognizing surgical activities with recurrent neural networks,” in *Proceedings of the International Conference on Medical Image Computing and Computer-Assisted Intervention (MICCAI)*, Istanbul, Turkey, 2016, pp. 551–558.

75 (figure 1a): A. R. Wu et al., “Automated microfluidic chromatin immunoprecipitation from 2,000 cells,” *Lab Chip*, vol. 9, no. 10, pp. 1365 –1370, 2009; (figure 1b): T.-M. Tseng, M. Li, B. Li, T.-Y. Ho, and U. Schlichtmann, “Columba: Co-layout synthesis for continuous-flow microfluidic biochips,” in *Proceedings of the 53rd ACM/EDAC/IEEE Design Automation Conference (DAC 2016)*, Austin, USA, 2016, no. 147, pp. 1–6.

79 (figure 1): B. H. Menze, K. Van Leemput, D. Lashkari, T. Riklin-Raviv, P. Gruber, S. Wegener, M. A. Weber, N. Ayache, P. Golland, “A generative model for brain lesion segmentation in multimodal and multitemporal image volumes – with application to tumor and stroke,” *IEEE Transactions in Medical Imaging* 2016. 35 (4), 933 – 946; (figure 2): P. Christ, M. Elshaer, F. Ettliger, S. Tatavarty, M. Bickel, P. Bilic, M. Rempfler, M. Armbruster, M. Hofmann, M. D’Anastasi, W. Sommer, A. Ahmadi, B.-H. Menze, “Automatic Liver and Lesion Segmentation in CT Using Cascaded Fully Convolutional Neural Networks and 3D Conditional Random Fields,” *Proc. MICCAI*, 2016.

83 (figure 2): E. Van Reeth, H. Ratiney, M. Tesch, D. Grenier, O. Beuf, S. J. Glaser, and D. Sugny, “Optimal control design of preparation pulses for contrast optimization in MRI,” submitted to *J. Magn. Reson.*, 2017.

97: Airbus Defence and Space, and Focus Group SADAS.

98 (figure 2): Airbus Defence and Space, and Focus Group SADAS; (figure 3): Focus Group SADAS.

100 (figure 1): J. Chen, C. Viatte, J. K. Hedelius, T. Jones, J. E. Franklin, H. Parker, E. W. Gottlieb, P. O. Wennberg, M. K. Dubey, and S. C. Wofsy, “Differential column measurements using compact solar-tracking spectrometers,” *Atmos. Chem. Phys.*, vol. 16, pp. 8479 – 8498, 2016.

102 (figure 1): M. Rexer, C. Hirt, S. J. Claessens, and R. Tenzer, “Layer-based modeling of the Earth’s gravitational potential up to 10km-scale in spherical harmonics in spherical and ellipsoidal approximation”, *Surveys in Geophysics*, vol. 37, no. 6, pp. 1035–1074, 2016.

- 103: C. Hirt, E. Reußner, M. Rexer, and M. Kuhn, "Topographic gravity modeling for global Bouguer maps to degree 2,160: Validation of spectral and spatial domain forward modeling techniques at the 10 microgal level", *Journal of Geophysical Research – Solid Earth*, vol. 121, no. 9, pp., 6846–6862, 2016.
- 107: Annette Menzel/TUM.
- 110: Lars Krüger ([www.lumivere.com](http://www.lumivere.com)).
- 111: Chair of Building Technology and Climate Responsive Design, TUM.
- 117: C. Camilloni, B. M. Sala, P. Sormanni, R. Porcari, A. Corazza, M. De Rosa, S. Zanini, A. Barbiroli, G. Esposito, M. Bolognesi, V. Bellotti, M. Vendruscolo, and S. Ricagno, "Rational design of mutations that change the aggregation rate of a protein while maintaining its native structure and stability," *Sci. Rep.*, vol. 6, p. 25559, 2016.
- 118 (figure 1): F. Kilchherr, C. Wachauf, B. Pelz, M. Rief, M. Zacharias, and H. Dietz, "Single-molecule dissection of stacking forces in DNA," *Science*, vol. 353, no. 6304, 2016.
- 119: J. Funke, P. Ketterer, C. Lieleg, S. Schunter, P. Korber, and H. Dietz, "Uncovering the forces between nucleosomes using DNA origami," *Sci. Adv.*, vol. 2, no.11, 2016.
- 120: J. Funke, and H. Dietz, "Placing molecules with Bohr radius resolution using DNA origami," *Nat. Nanotechnol.*, vol. 11, no. 1, pp. 47–52, 2015.
- 121: P. Ketterer, E. Willner, and H. Dietz, "Nanoscale rotary apparatus formed from tight-fitting 3D DNA components," *Sci. Adv.*, vol. 2, no. 2, pp. e1501209, 2016.
- 125 (figure 1): J. Behnke, M. J. Mann, F. L. Scruggs, M. J. Feige, and L. M. Hendershot, "Members of the Hsp70 family recognize distinct types of sequences to execute ER quality control," *Mol. Cell*, vol. 63, no. 5, pp. 739–752, 2016; (figure 2): Joshua Stokes, St. Jude Children's Research Hospital.
- 129: A. Taudt, M. Colome-Tatche, and F. Johannes, "Genetic sources of population epigenomic variation," *Nat. Rev. Genet.*, vol. 17, no. 6, pp. 319–332, 2016.
- 130 (Kessler): [facesbyfrank](http://facesbyfrank).
- 132: Reidar Hahn/Fermilab.
- 133 (figure 1): A. Bazavov, N. Brambilla, H.-T. Ding, P. Petreczky, H.-P. Schadler, A. Vairo, and J. H. Weber, "Polyakov loop in 2+1 flavor QCD from low to high temperatures," *Phys. Rev. D*, vol. 93, no. 11, art. 114502, 2016.; (figure 2): A. Bazavov, A. S. Kronfeld, et al., "B<sup>0</sup>-mixing matrix elements from lattice QCD for the Standard Model and beyond," *Phys. Rev. D*, vol. 93, no.11, art. 113016, 2016.
- 134: S. Biondini, N. Brambilla, and A. Vairo, "CP properties of heavy Majorana neutrinos at finite temperature: the hierarchical case," *J. High En. Phys.*, vol. 1609, art. 126, 2016.
- 136: Neil Grant.
- 147: [jozefmicic/iStockphoto](https://www.istockphoto.com).
- 148: Klinikum der Universität München.
- 149 (figure 1): R. Ensenauer, "Globale Epidemie Adipositas. Beginnt kindliches Übergewicht im Mutterleib?" *Gyne* 9:22–24, with kind permission of the Mediengruppe Oberfranken – Fachverlage GmbH und Co. KG.; (figure 2/mass spectrometer): <https://www.helmholtz-muenchen.de/gac/platforms/metabolomics/instrumentation/index.html>.
- 152 (figure 1): S. F. Lichtenthaler, B. F. O'Hara, and C. P. Blobel, "iRhoms in the brain - a new frontier?" *Cell Cycle*, vol. 14, no. 19, pp. 3003–3004, 2015.
- 168: R. Schmidt and M. Knap, "Quasiteilchen in Zeitlupe," *Physik in unserer Zeit*, vol. 48, no. 1, pp. 6-7, 2017.
- 169: P. Bordia, H. Lüschen, U. Schneider, M. Knap, and I. Bloch, "Periodically driving a many-body localized quantum system," *Nat. Phys.*, 2017, accepted in 2016.
- 174: IBM Research.
- 175: B. Loitsch, M. Müller, J. Winnerl, P. Veit, D. Rudolph, G. Abstreiter, J. J. Finley, F. Bertram, J. Christen, and G. Koblmüller, "Microscopic nature of crystal phase quantum dots in ultrathin GaAs nanowires by nanoscale luminescence characterization," *New J. Phys.*, vol. 18, pp. 063009, 2016.
- 176: Craig Lee/Stanford University.
- 178 (Brune): Photo Tornow.

## 220 Imprint

### Editors

Erica Gingerich  
Eva Pettinato  
Ernst Rank  
Tatjana Steinberger

### Designer

Christian Klette

### Photographers

Astrid Eckert  
Andreas Heddergott

### Printed by

Druckerei Joh. Walch GmbH & Co, Augsburg

### Publisher

Technical University of Munich  
Institute for Advanced Study\*  
Lichtenbergstraße 2 a  
85748 Garching  
Germany  
Phone: +49.89.289.10550  
Fax: +49.89.289.10699  
Email: [info@ias.tum.de](mailto:info@ias.tum.de)  
Web: [www.ias.tum.de](http://www.ias.tum.de)

\* as of December 2016

The TUM Institute for Advanced Study is funded by the German Excellence Initiative (Deutsche Forschungsgemeinschaft - DFG).



Cover and inside cover:

The picture featured on the cover is a detail from a gravity field map representing anomalies in the Earth's gravity field over the Himalaya Mountains. Red color signatures indicate stronger gravitational effects over the range's highest peaks. Data for the image is courtesy of GGMplus, which is the highest-resolution world gravity field map in existence today. The map was developed by members of the TUM-IAS Focus Group High-Resolution Gravity Modeling.

Reference: C. Hirt, S. J. Claessens, T. Fecher, M. Kuhn, R. Pail, and M. Rexer, "New ultrahigh-resolution picture of Earth's gravity field," *Geophysical Research Letters*, vol. 40, no. 16, pp. 4279–4283, 2013.

**Technical University of Munich**  
**Institute for Advanced Study**  
Lichtenbergstraße 2 a · 85748 Garching  
Germany  
+49.89.289.10550  
info@ias.tum.de  
www.ias.tum.de