

**TES EnergyFaçade –
prefabricated timber based building system
for improving the energy efficiency of the
building envelope**

**funded by:
Woodwisdom Net**

Research project from 2008-2009

Content

1.1.	Modernisation - the 2nd chance for architecture	19
1.2.	TES method - Systemised workflow	23
2.	Building stock	31
2.1.	Energy efficiency in Building Stock	36
2.2.	Resource Efficiency in Building Stock	38
2.3.	Systemisation	40
2.3.1.	Building geometry	41
2.3.2.	Foundation	42
2.3.3.	Exterior wall	46
2.3.4.	Window	50
2.3.5.	Ceiling / balcony	56
3.	TES Method	60
3.1.	Survey and Digital Workflow	64
3.1.1.	Economic survey	67
3.1.2.	Methods of geometrical building survey	68
3.1.3.	3D Laser-scanning for TES projects: possibilities and challenges	74
3.1.4.	Reality versus model: Accuracy / Tolerances	76
3.1.5.	Digital Workflow	78
3.1.6.	Case study of a façade survey	85
3.2.	Environmental Impact and Life Cycle	88
4.	TES System	98
4.1.	TES Element	100
4.1.1.	Form and Function	104
4.1.2.	Adaption layer	107
4.1.3.	Windows	114
4.2.	Mounting and Fixation	120
4.2.1.	Mounting	120
4.2.2.	Load Bearing	121
4.2.3.	Element façades fixation joints	125
4.3.	Building Physics	127
4.3.1.	Fire Safety of Façades	127
4.3.2.	Hygrothermal (Heat, Air, Moisture) and Air / Wind Tightness	135
4.3.3.	Cavities in adaption layer and drying potential in existing wet walls	143
4.3.4.	Acoustics (Sound Protection)	146
4.4.	Building services	148
5.	Quality assurance	156
5.1.	Regulations	157
5.2.	TES specification	158
5.3.	Design recommendations for TES EnergyFaçade	159
6.	Pilot Projects in Europe	164
6.1.	Realschule, Buchloe, Germany	165
6.2.	Technical College, Risør, Norway	173
6.3.	Student Housing, Oulu, Finland	185

Graphics and Pictures

1. Modernisation workflow	19
2. TES EnergyFaçade building method.	19
3. Global warming map, © by NASA.	20
4. Possible interventions	22
5. Schwanenstadt, Austria School before and after modernisation; PAUAT Architekten, 2004	23
6. Risør College, Norway Prefabricated façade elements with close boarding, assembled in 2009.	23
7. Retrofit interventions for energy efficiency.	24
8. Prefabricated façade element assembly at Realschule Buchloe.	25
9. Simplified lifecycle model of a TES EnergyFaçade retrofit.	26
10. Wide variety of surface solutions for TES.	28
11. Residential units by building age class, Germany.	32
12. Typical apartment houses of the post war era.	33
13. Typology of relevant building types.	34
14. Typological floor plans with corridor houses and terraced houses (from left t. r.): acc. to Neufert, 1973.	35
15. Typological floor plans with centralised access (from left t. r.): double dwelling, triple dwelling, staggered dwelling, Point block, acc. t. Neufert, 1973.	35
16. Examples of German dwellings from the 60s and 70s in Nuremberg.	35
17. Building stock clustered in building age classes and its specific heat energy demand.	36
18. Type of heating system in residential units in millions.	37
19. Load bearing outer walls versus a skeleton structure with infill.	40
20. Base with cellar window	42
21. Window and light shaft, DH Weissenseestraße, Augsburg	42
22. Raised ground floor, MFH Hinterbärenbadstraße , München	43
23. Flat terrain.	43
24. Tilted terrain.	43
25. Separate foundation	44
27. Fixation of brackets, Realschule Buchloe, 08/2009	44
26. Bracket at ceiling edge	44
28. Single layered masonry	46
29. Insulated sandwich element	46
30. Ventilated structure	46
31. Principle heat transmission	47
32. Isotherm curve of an uninsulated exterior corner. Temperature on the surface inside is below the critical Temperature of 12,6 °C.	47
34. Joint in concrete skeleton structure	48
33. Façade joints in existing constructions.	48
35. Heat bridge at roof eaves: no heat bridge or a negligible geometric one (left), on the right there is a constructional heat bridge remaining.	49
36. Inner stop against outer reveal projection	50
37. Outer stop against inner reveal projection	50
38. Flat connection to reveal	50
39. Situation interior against façade columns	50
40. Situation in front of façade columns	50
41. Flat connection between columns	50
42. Interior rolling shutter box and radiator niche, brick masonry 30 cm, D-Augsburg	53
44. Double layered brick masonry with timber framed window element, 10 cm, poor insulation standard, NL-Roosendaal	53

43. Exterior shutter box, D-Augsburg	53
45. Curtain wall at stair case, loggia with additional glazing for noise protection, D-Augsburg	53
46. Spandrel panel ribbon glazing	54
47. Window, aluminium flat against reveal and parapet.	54
48. Window sill, cable channel and radiator in front off parapet. D-München, Umweltamt	54
49. Exterior structural glazing façade with rotating tilting frames, sun shading device, D-Buchloe, Realschule	54
50. Timber frame wall with poor insulation, large window areas, NOR- Rsior, College	55
52. Ceiling and balcony constructions.	56
51. Two types of exterior wall construction.	56
53. Cantilevering slab	57
55. Partly cantilevered slab	57
54. Loggia	57
56. Balcony	57
57. Cutting off balcony slab	58
58. TES process diagram.	60
60. Prefabrication degrees	62
59. Prefabrication and installation process.	62
61. Comprehensive inspection of a property.	64
62. The prefabricated TES element has to fit on the existing façade like a stencil.	65
63. Irregularities of a façade with a size of around 32 x 9 m. The maximum deviation perpendicular to the surface plane is in total between 30 and 40 mm.	65
64. Example Rotlintstrasse, Frankfurt, Germany. A typical post-war building from the early 1950s.	66
65. Influencing parameters on several measuring methods used in façade survey (close to centre is not recommended). Hand measuring is mentioned for comparison, but it is not competitive as it lacks 3D properties.	67
66. Benefit-cost ratio of the used measuring methods. Source Rauch 2008.	68
67. Typical application of a reverse engineering process with uneven surfaces in dental technology.	69
68. Multi-image 3D photogrammetry - postprocessing / 3D modeling of discreet façade points.	69
69. A modern Tacheometer also called Totalstation.	70
70. Full featured 360° 3D Laserscanner on a tripod.	70
71. Entire raw data model consisting of a registered and cleaned point cloud, taken by a 3D laserscan.	71
72. Critical points of a façade survey.	76
73. 3D model of the timber fabricator providing the façade for Realschule Buchloe, produced in july and assembled in august 2009.	80
74. 3D wireframe model of the Realschule Buchloe was basis for the product model of the timber fabricator, surveyed in june 2009.	81
75. Step by step development of a product model (BIM) from survey data.	82
76. Necessary steps of a TES survey campaign based on Scherer's paradigm.	83
77. (a) Definition of a façade plane, (b) insertion of volumetric solids in the position of a window opening, (c) collision control between pointcloud and solid. Continuation of the iterative process by further adjustment and collision control.	84
78. Criteria and relation cost - complexity of 3D models.	84
79. Case study building from the 1950s located in Frankfurt, Germany.	85
80. 3D Wireframe model of Rotlinstraße, Frankfurt.	85
81. 3D parametric model in SEMA after importing and postprocessing the wireframe model.	85
82. Rectified image (left) and digital surface model (DSM) of the façade (right), showing the topography in different colours (deviation to perpendicular to reference plane - each colour corresponds a 5 mm step in height).	87
84. The three pillars analogy of sustainability.	88
83. Product life cycle of TES EnergyFaçade. The main construction material is mainly timber based and can be reused or easily recycled at its end of life.	88
85. System borders for sustainability and LCA of TES.	89

87. Lifecycle of an entire building and lifecycle of modernisation products.	90
86. Concept of description of sustainability due to CEN / TC 350 as basis for the EN 15643.	90
88. Typical technical lifetime of different façade modernisation systems and the related eco-indicator 99.	91
89. Specification of different insulation materials concerning heat conductivity and primary energy intensity (non-renewable). The thicknesses of insulation is standardized to a U-value of 0,2 kWh/m ² in this case. The red boxes show the contained primary energy (PEI) per m ² . The data is based on the Ökobau.dat delivered by German Federal Ministry of Construction.	92
91. Basic TES application and system hierarchy with; a) existing structure, b) adaption layer, c) timber framework and insulation as main layer, d) cladding layer on the exterior side.	98
92. Variation of cladding materials in combination with a TES basic element.	99
93. Variation in size and orientation of TES elements.	100
94. Basic TES element with a) insulation b) panelling and c) structure.	101
95. Different TES structure compositions based on the same principle of a framed wall element.	102
96. Elements for Realschule Buchloe.	105
97. Horizontal and vertical division - spatial enclosure and extension.	105
98. Self-supporting structure with own foundation and roof extension (left), partly suspended structure (right).	106
99. Ceiling slabs able to take loads in each storey.	106
100. Basics concept of an element-façade	106
101. Fixation of adaption layer on the existing wall. Depicted here is a Heraklith surface, Realschule Buchloe	107
102. Element joint at sill	107
103. Overview entire test assembly. Left a two storey and right a small sized, single storey element.	108
104. Element edges and their sealing.	108
105. Drawing of the two storey element.	109
106. Drawing of small element.	110
107. Window sill and reveal with sealing.	111
109. Trailer based standard ISOBLOW station.	111
108. Insulation perforated by hose	111
110. Filling procedure	111
111. Hole for control of filling	112
112. Joints sealed with PU foam.	112
113. Drilled hole for filling hose.	112
114. Dust emission through boreholes.	113
115. Control opening: Cellulose fibre filling (bottom) and SLS filling (top)	113
116. Elevation, vertical and horizontal section of a basic TES structure and layering.	114
117. Distribution of illuminance values.	115
118. Rendered interior view of a room with one window and deep reveals.	115
119. Window replacement in masonry wall construction. New window is fully integrated in insulation layer.	116
120. Conservation of existing window and an additional exterior window integrated in the insulation layer.	117
121. Enlargement of existing window geometry (french window).	118
123. Airtight joint at window reveal with a double layer gypsum fibre board	119
122. Vertical section window lintel with air-tight sealing of the gap (adaption layer).	119
124. Precise adjustment of edge beam for fixation of elements.	120
125. Distance of scaffolding for mounting purpose.	120
126. Operating range of crane and other lifting devices.	120
127. Different lifting equipment with mobile crane etc.	120
128. Lifting solution for façade elements beneath roof overhang or structured façades, balconies etc. Developed by O.LUX, Georgensgmünd	120
129. Supports of TES element.	121
130. Loads on TES element.	121

131. Typology of mounting elements a) hanging, b) storey wise mounted, c) standing, d) storey wise standing.	121
132. Load bearing survey process.	122
134. Pull test at an existing concrete wall.	123
135. Adhesive anchors for concrete or masonry walls.	123
133. Existing condition analysis.	123
136. L- bracket with a sill beam.Exchange of brick layer in front of the ceiling, grouting closer.	124
137. Cantilever beame.g. IPE rocker. Fixation under basement ceiling, grouting closer	124
138. FoundationPrecast concrete component, frost resistance founded, adaption layer thermal insulation.	124
139. Fixation possibilities of TES modules a) punctiform support b) linear horizontal supp. c) linear vertical supp. d) hinge fixation	125
140. Different types of elements joints and sealing solutions.	126
141. Fire scenarios for TES façade and critical joints (red circles).	127
142. Building and façade structure of existing buildings a) punctuated monolithic wall structure b) skeleton structure c) crosswall structure.	128
144. TES EnergyFaçade assembly with panelling and insulation for EI30 (grey). Horizontal fire stops (blue) for ventilated gaps of façade and floorwise separation of stacked windows.	129
143. Layers of a basic TES façade.	129
145. TES EnergyFaçade a) in front of load-bearing b) or non load-bearing external wall.	130
146. Spread of fire scenarios into upper storeys: over the façade layer (left), over the windows (middle), through the construction of the exterior walls (right).	131
147. Partitioning with fire stops in order to prevent the spread of fire a) fire stops around windows b) horizontally storey-wise separation of the elements.	132
148. Partitioning with fire stops in order to prevent the spread of fire c) vertical and window fire stops together for vertical TES EnergyFaçade assembly, d) horizontal fire stops separate each storey and vertical fire stops between functional units.	132
149. Situation of the simulated existing window joint. Aluminium window frame with outdoor climate (top) and indoor climate (bottom).	139
150. Temperature diagram of the section through TES and existing concrete wall.	140
151. Isotherms of the wall/window section. Lowest indoor temperature is indicated with 11,24 °C.	140
153. Situation of the simulated new window joint in insulation layer. Timber window frame with outdoor climate (top) and indoor climate (bottom).	141
152. Detail view on the coldest indoor surface point.	141
155. Moisture and wind protection, interior side (left) with air tight layer and exterior (right) with wind tight layer.	142
154. Isotherms of the wall/window section. Lowest indoor temperature is indicated with 11,24 °C.	142
156. Material properties and dimensions list, screenshot of WUFI® 4.2.	144
157. Simulation of existing wet wall with 18 cm TES EnergyFacade done with WUFI® 4.2. The graph shows the decrease of the total amount of water in the entire, insulated exterior wall construction	144
158. Temperature and dew-point diagram of the adaption layer during a range of three years. The red line indicates the temperature curve while the pink line shows the dew point temperature. The position is on the outside of the wood fibre hard board or the interior side of the TES element.	145
159. Humidity diagram of the cellulose fibre insulation layer shows the good drying capabilities during a range of three years. The overall mass of moisture in the element decreases.	145
160. Horizontal decoupling of elements and adaption layer decoupling existing wall.	146
161. Brackets and sill beam as linear anchoring solution with decoupling on the sill..	146
162. Brackets as punctiform anchoring solution with decoupling on the bracket..	147
163. Vertical decoupling of elements and adaption layer decoupling existing wall.	147
164. Concept of building service integration	148
165. Vertical section with possible installation zone in adaption layer.	150
166. Horizontal section shows example of ductwork.	150
167. Transport of lying elements on bridge plate.	151

168.	View from east (street side): the green plastic sheeting protects the new elements	151
169.	View from north: The extra top floor enjoys a spectacular view over Zurich and the mountains. The expected rent income „finances“ the modernisation of the whole project	151
170.	Layering of element in front of existing wall (left side).	152
171.	Roof extension of existing apartment block.	152
172.	Basebeam with styrofoam insulation	152
173.	Beam carrying the load to the first floor ceiling.	152
174.	Vertical HVAC routing.	153
175.	Weather protect elements (left) and HVAC routing vertical (right) and horizontal (top right).	153
176.	View from above into the recessleft is the top of the new elementright is the wall of the raised floor	154
178.	View into the setback. Transformation from horizontal to vertical pipe leading. This pipe is connected a lower floor.	154
177.	View of the bundle of pipes leadingdown into the central HVAC space	154
179.	Pipe lead through above a window	154
180.	Insulated building envelope	160
181.	TES elements on a trailer.	161
182.	Assembly of TES element.	161
183.	Overview of pilot project locations	164
184.	Realschule Buchloe, Germany	165
185.	Site plan 1:5000	166
186.	Existing school building	166
187.	Existing building entrance	167
188.	2nd floor plan, M. 1:500	167
189.	Before modernisation - concrete balconies	168
190.	Demolition of balconies and old façade	168
191.	Trimming shop	169
192.	Façades after modernisation	169
193.	Mounting of TES elements	169
194.	CAD/CAM model of elemented façade ready for production.	170
196.	Cross section, Façade, M. 1:2	170
195.	Survey result - 3D wireframe model of the main structure, ceilings and columns.	170
197.	Façade edge - fully glazed	171
198.	New ventilation system in the suspended ceiling	171
199.	Façade with partially closed sun shades	171

Tables

1. Characteristics of TES method	20
2. Table: German thermal protection regulations compared to „Passivhaus“ rules.	36
3. Interrelation of project steps	63
4. Table: Eligibility of modern survey methods.	72
5. Comparison of measuring methods for façade surveying tasks.	73
6. Table: Comparison of accuracy of different measuring methods.	77
7. Table: Required prefabrication tolerances and general building standards.	78
8. Different possible claddings of a TES EnergyFaçade.	99
9. Adaption layer insulation materials.	103
10. Requirements of panelling layers depending on its position.	104
11. Insulation of the cavities can follow two different time schedules.	107
12. Synopsis of requirements and consequences for window replacement.	116
13. Synopsis of requirements and consequences for window addition.	117
14. Synopsis of requirements and consequences for window enlargement.	118
15. Sealing methods for different kinds of impact.	126
16. General objectives and specific explanation.	127
17. Typology of existing structures and external walls.	128
18. Existing buildings (≥ 3 storeys) with TES EnergyFaçade. German fire safety rules in brackets according to DIN 4102.	130
19. Synopsis of European facade fire requirements, by courtesy of the Woodwisdom-Net research project: Fire in Timber, 2008-2010.	133
20. U-Values of different construction parts and their historical development.	136
21. s_d -Values of existing wall constructions.	143

Literature

- IPCC, Forth Assessment Report, 2007 20
- http://ec.europa.eu/energy/efficiency/buildings/buildings_en.htm, verified 28.05.2010 20
- COM(2008) 397 final, Communication from the Commission to the European Parliament, The Council, The European Economic and Social Committee and the Committee of the Regions on the Sustainable Consumption and Production and Sustainable Industrial Policy Action Plan, <http://eur-lex.europa.eu/LexUriServ/LexUriServ.do?uri=CELEX:52008DC0397:EN:NOT>, verified 06.11.2009. 20
- http://www.ipcc.ch/publications_and_data/ar4/wg3/en/ch6s6-es.html, verified 10.08.10, 14:00 21
- Schulze-Darup B. (2004) Energetische Gebäudesanierung mit Faktor 10, Deutsche Bundesstiftung Umwelt, Osnabrück. 21
- Hegger, Fuchs, Stark, Zeumer (2007) Energie Atlas, Institut für internationale Architektur-Dokumentation, München. 22
- Wegener et al. (2010) Bauen mit Holz = aktiver Klimaschutz, TUM Holzforschung München, München. 23
- Institut Wohnen und Umwelt (IWU) (ed.) (2006): Gebäudetypologie Bayern, Darmstadt, p. 15ff. 24
- Kolb, Josef (2007) Holzbau mit System, Birkhäuser, Basel. 25
- prEN 15643:2009: Sustainability of construction works. Assessment of buildings. 26
- Wegener et al. (2010) 27
- Destatis (2006), Mikrozensus-Zusatzerhebung 2006 - Bestand und Struktur der Wohneinheiten - Fachserie 5 Heft 1 31
- Passivhaus Institut, <http://www.passiv.de>, verified 06.11.2009. 37
- Schulze-Darup (ed.) (2008) Energetische Gebäudesanierung mit Faktor 10, Deutsche Bundesstiftung Umwelt (DBU) research report series, Osnabrück. 37
- SIA D0200 (2004) SNARC, Systematik zur Beurteilung der Nachhaltigkeit von Architekturprojekten für den Bereich Umwelt, Zürich. 38
- Fechner O. (2009) Einsatz von Holzbauerelementen zur energetischen Gebäudesanierung öffentlicher Nichtwohnungsbauten in: Proceedings Timber Construction NordBau 2009, Lübeck. 38
- BBR (ed.) (2001) Leitfaden Nachhaltiges Bauen, Bonn. http://www.nachhaltigesbauen.de/fileadmin/pdf/PDF_Leitfaden_Nachhaltiges_Bauen/Leitfaden.pdf, verified 20.10.2010. 39
- IWU (ed.) (2006): Gebäudetypologie Bayern, Darmstadt. p.15ff. 39
- Riedel W., Oberhaus H., Frössel F., Haegele W. (2007) Wärmedämm-Verbundsysteme, Fraunhofer IRB Verlag. 42
- Schmitt (1988) Hochbaukonstruktion, Vieweg, Braunschweig. 58
- Bergdoll B. et.al. (2008) Home Delivery, Birkhäuser, Basel. 62
- Kolb J. (2007) Holzbau mit System, Birkhäuser, Basel. 63
- Spar Point Research LLC (2006) Capturing Existing Conditions with Terrestrial Laser Scanning. Document downloaded from <http://www.sparllc.com>. verified 24.08.09. 64
- Abella R. J., Daschbach J. M., McNichols R. J. (1994) Reverse engineering applications. Computers and Industrial Engineering, 26(2), pp. 381–385. 64
- Rajala, M. & Penttilä, H. (2006) Testing 3D Building Modelling Framework in Building Renovation. In: 24th eCAADe Proceedings, Volos (Greece), pp. 268-275. 65
- Göttig, R. & Braunes, J. (2009) Building Survey in Combination with Building Information Modelling for the Architectural Planning Process. In: 27th eCAADe Proceedings, Istanbul, pp. 69-74. 65
- Rauch S. (2008) TES EnergyFaçade, Fassadendokumentation der Rotlintstraße 116-120, Frankfurt am Main, Technical Report from Department of Geodesy, Prof. T. Wunderlich, TU München. 67
- Raja V., Fernandes K. J. (2008) Reverse Engineering – An Industrial Perspective. Springer. London, 2008. 68
- Luhmann, T. (2002) Photogrammetrie und Laserscanning Anwendungen für As-Built-Dokumentation und Facility Management. Wichmann Verlag, Heidelberg. 70
- El-Hakim, S.F. & Beraldin, J.-A. (2007) Sensor Integration and Visualization. In: Fryer, J., Mitchell, H. & Chandler, J. (eds) Applications of 3D Measurement from Images: Dunbeath: Whittles Publishing. 72
- Scherer, Michael (2001) Objekterfassung: Was? – Wie? – Wozu?, Eine Analyse mit Schwerpunkt bei der Bauaufnahme, In: Flächenmanagement und Bodenordnung, 4/2001, pp. 188 – 199. 74

http://www.gsa.gov/gsa/cm_attachments/GSA_DOCUMENT/GSA_BIM_Guide_Series_03_R2C-a3-I_0Z5RDZ-i34K-pR.pdf , verified 24.08.2009	74
Gottwald, R. & Knabl, T. (2008) 3D Measuring for Building Refurbishment. In: Reporter. The Global Magazine of Leica Geosystems, 59, pp. 28-31.	76
Rauch S. (2008)	77
Dohmen, P. & Rüdener, K. (2007) Digital Chains in Modern Architecture. In: Kieferle, J.B. & Ehlers, K., Predicting the Future. Proceedings of the 25th Conference on Education in Computer Aided Architectural Design in Europe (eCAADe 25), pp. 801-804.	78
Eastman, C., Teicholz, P., Sacks, R. & Liston, K. (2008) BIM Handbook. A Guide to Building Information Modelling for Owners, managers, Designers, Engineers, and Contractors. Hoboken, New Jersey: John Wiley & Sons; p. 15.	79
Howell, I. & Batcheler, B. (2005) Building Information Modelling Two Years Later. The Laiserin Letter, May 2005. www.laiserin.com	79
Morad, S. (2008) Building Information Modelling and Architectural Practice: On the Verge of a New Culture. In: First International Conference on Critical Digital: What Matters(s)?: Harvard University Graduate School of Design, Cambridge (USA); pp. 85-90.	79
Mitchell, J., Wong, J. & Plume, J. (2007) Design Collaboration Using IFC. A Case Study of Thermal Analysis. In: Proceedings of the 12th International Conference on Computer Aided Architectural Design Futures, Sydney (Australia); pp. 317-329.	79
Eastman et al (2008), p. 15.	80
Rajala, M. & Penttilä, H. (2006) Testing 3D Building Modelling Framework in Building Renovation. In: 24th eCAADe Proceedings, Volos (Greece), pp. 268-275.	80
Bosche F., Haas C.T., Akinci B. (2009) „Automated Recognition of 3D CAD Objects in Site Laser Scans for Project 3D Status Visualization and Performance Control“, ASCE Journal of Computing in Civil Engineering, Special Issue on 3D Visualization, Volume 23, Issue 6 (to appear).	80
Jeong, Y.-S., Eastman, C.M., Sacks, R, Kaner. I. (2009) Benchmark tests for BIM data exchanges of precast concrete. In Automation in Construction, 18, 2009, pp.469-484.	82
Schleinkofer M., Schäfer T. (2005) Vom Laseraufmaß zum Produktmodell für Altbauten. Abschluss-symposium des BayFORREST-Forschungsverbundes „Stoffflussmanagement Bauwerke“ Zum Thema „Nachhaltigkeit bei Planung, Nutzung und Sanierung von Bauwerken“, TU München, 15. Sep. 2005.	82
http://www.menci.com/zscan.html ; http://www.photomodeler.com/products/pm-scanner.htm , verified 20.04.2010.	87
Brundtland, G. H. (1987) first published 1987; http://en.wikisource.org/wiki/Brundtland_Report (31.08.2009).	88
Rudolphi, A. (2009) Lebenszyklusanalyse von Bestandsgebäuden; in: Sick, F. (ed.): 3. Internationales Anwenderforum Energetische Sanierung von Gebäuden, Ostbayerisches Technologie-Transfer-Institut, Kloster Banz, Bad Staffelstein 27.03.2009; Regensburg; 2009.	89
prEN 15643-1:2009 and prEN 15643-2:2009	89
DIN EN ISO 14040 and DIN EN ISO 14044	89
DIN 18960	89
Rudolphi (2009).	92
Wegener et al. (2010)	93
DIN EN ISO 14040 Environmental management - Life cycle assessment - Principles and framework.	94
DIN 4108-3 Thermal protection and energy economy in buildings - Part 3: Protection against moisture subject to climate conditions; Requirements and directions for design and construction.	100
DIN 5034-1 Daylight in interiors - Part 1: General requirements.	115
Musterbauordnung (MBO), (2002) German design building regulation.	115
http://www.dial.de , professional light planning software for artificial light & daylight	115
Kaufmann H., Lattke F., Ott S., Winter S. (2010) Gebäudemodernisierung in vorgefertigter Holzbauweise - Bauablauf, Aufmasstechniken, Konstruktion, Brandschutz. Mikado, (3), weka Verlag, Kissing.	134
Musterbauordnung (2002)	134
DIN 4108-2 Thermal protection and energy economy in buildings - Part 2: Minimum requirements to thermal insulation.	136

DIN EN ISO 13788 Hygrothermal performance of building components and building elements - Internal surface temperature to avoid critical surface humidity and interstitial condensation - Calculation methods (ISO 13788:2001); German version EN ISO 13788:2001	137
Sedlbauer et al. (2004) Moisture buffering effects of interior linings made from wood or wood based products, Fraunhofer-Institut für Bauphysik (ed.), Stuttgart.	137
DIN 4109 Sound insulation in buildings; requirements and testing.	146
DIN EN 12354-1 Building acoustics - Estimation of acoustic performance of buildings from the performance of products - Part 1: Airborne sound insulation between rooms; German version EN 12354-1:2000.	146
http://www.empa-ren.ch/a50.htm , IEA ECBCS Annex 50, "Prefabricated Systems for Low Energy Renovation of Residential Buildings", verified 04.07.2010.	148
Part 1 [RAL-GZ 422/1], Herstellung vorgefertigter Bauprodukte (Production of prefabricated construction products). Part 2 [RAL-GZ 422/2], Errichtung von Gebäuden (Montage), (Construction of buildings (assembly)).	157
http://www.iee-square.eu . For example: Kovacs, P., Mjörnell, K., SQUARE - A System for Quality Assurance when Retrofitting Existing Buildings to Energy Efficient Buildings, last checked 17.08.2009	158

Abstract

The improvement of the energy efficiency of the envelope of buildings built from 1950-1980 is a major benefit to the energy saving potential as well as a vital contribution to the reduction of the household's total CO₂ emissions.

The goal of the project was to develop a façade renovation method (TES method) based on large scale, timber based elements for the substantial improvement of the energy efficiency of a renovated building, which would be applicable throughout Europe.

The target of the TES method is primarily focused on the building's energy efficiency improvement and as a consequence in the reduction of GHG emissions. Every activity in construction is responsible for the consumption of additional resources in the form of raw materials or energy and therefore causes emissions. A possible solution to this dilemma is the adoption of a sustainable and ecological retrofit method based preferably on biogenic materials. The timber based value chain offers an enormous potential to activate the carbon stock as timber is the only re-grown building material. Along the value chain of timber, combustion of wood has to stand last.

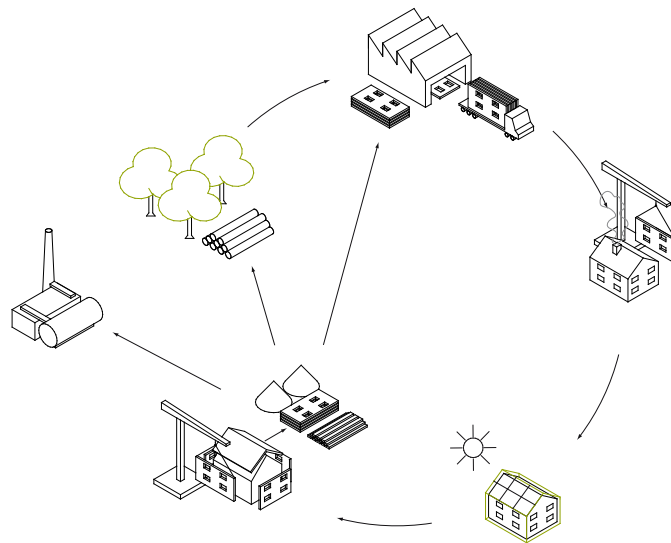

TES EnergyFaçade has defined basic principles for the energetic modernisation of the building envelope using prefabricated large-sized timber frame elements. The basis for the use of prefabricated retrofit building elements is a frictionless digital workflow from survey, planning, off site production and mounting on site based on a precise initial 3D measurement.

The outstanding properties of the application of TES EnergyFaçade are:

- Precision and quality of an ecological building system
- Predictable pricing and reduction of work on-site
- Reduction of noise and disruption of the inhabitants
- Application of a great variety of cladding materials
- Integration of load bearing elements
- Integration of HVAC and solar-active components
- Spatial intervention or expansion (modules) in the same system

Preface

TES Energy Façade [a timber based element system for improving energy efficiency of the building envelope] (www.tesenergyfacade.com) is a research project within the transnational WoodWisdom-Net Research Programme (www.woodwisdom.net <<http://www.woodwisdom.net>>) which received public funding from Germany (Federal Ministry of Education and Research, Project Management Jülich), Finland (Tekes – the Finnish Funding Agency for Technology and Innovation) and Norway (The Research Council of Norway).

During 2008-2010 researchers from Finland, Germany and Norway realised a research project titled *Timber-based element systems for improving the energy efficiency of the building envelope* (TES EnergyFaçade). The goal was to develop a façade renovation method (TES method) based on large scale, timber based elements for the substantial improvement of the energy efficiency of a renovated building, which would be applicable throughout Europe. Buildings targeted for the renovation method included those built between the 1950s and 1980s, in particular those earmarked for major renovations in the near future.

Team

Finland:

Aalto Korkeakoulusäätiö (Aalto University, AALTO), Helsinki
Chair for Wood Construction, Prof. Pekka Heikkinen, TKK

Laboratory of Structural Engineering and Building Physics,
Professor Dr. Jari Puttonen

Laboratory of Wood Technology, Prof. Dr. Matti Kairi, TKK

Woodpolis Oy

NCC rakennus Oy

Stora Enso Timber Oy Ltd.

Puuinfo Oy

Housing Finance and Development Centre – ARA
Kiinteistöliitto (The Finnish Real Estate Federation)

Germany:

Technische Universität München
Fakultät für Architektur, Fachgebiet Holzbau,
Univ. Prof. Hermann Kaufmann

Fakultät für Bauingenieur- und Vermessungswesen,
Lehrstuhl für Holzbau und Baukonstruktion,
Univ. Prof. Dr.-Ing. Stefan Winter

Anton Ambros GmbH

Gumpp & Maier GmbH

O.Lux Holzbau GmbH & Co.

Norway:

Norwegian University of Science and Technology, Trondheim

Faculty of Architecture and Fine Arts, Prof. Knut Einar Larsen

Faculty of Engineering Science and Technology, Prof. Knut R. Holm

Trebyggeriet AS

Arkitekstudio Bodø AS

Editors of the TES manual:

Prof. Pekka Heikkinen, Aalto University, Finland
Prof. Hermann Kaufmann, TU München, Germany
Prof. Dr.-Ing. Stefan Winter, TU München
Prof. Knut Einar Larsen, NTNU, Norway

The guideline has been written by the TES EnergyFaçade research partners. The following persons are responsible for the chapters:

Frank Lattke (Chapter 1, 2 and 5)
Knut Einar Larsen (Chapter 3.1)
Stephan Ott (Chapter 2, 3.2 and 4)
Yrsa Cronhjort (Chapter 6)

TES Research project: Method description

Our research team combines the experience from scientists and fabricators of timber framed elements from the timber construction sector in 3 nations (Finland, Germany and Norway), working in close collaboration and driven by the common objective of bringing the experiences of the timber building sector and prefabrication methods into the field of renovation: thus exploring new markets and contributing to the challenge of reducing the global CO₂ footprint. The intensive exchange between research and entrepreneurs stimulated the whole process in this project.

STAGE 1: Investigation and statement of requirements

Learning from built projects. A general survey of the typology of the existing real estate stock on a national level with a focus on the suitability for the renovation with prefabricated elements was followed by the definition of the most important and numerically relevant types. This led to drawing up of the specific demands for the renovation of the building envelope.

STAGE 2: Systemisation of requirements

The results were compiled, compared and discussed at an early stage. The objective being the definition of a concerted statement of requirement regarding national specifics. Within a broad variety of possibilities a number of solutions were identified through critical analysis, and were then jointly perfected.

STAGE 3: Design / implementation and project documentation

The national partners developed prototypes according to their specific work package that were tested and evaluated on suitable pilot projects in the partners' countries. The results were jointly analysed.

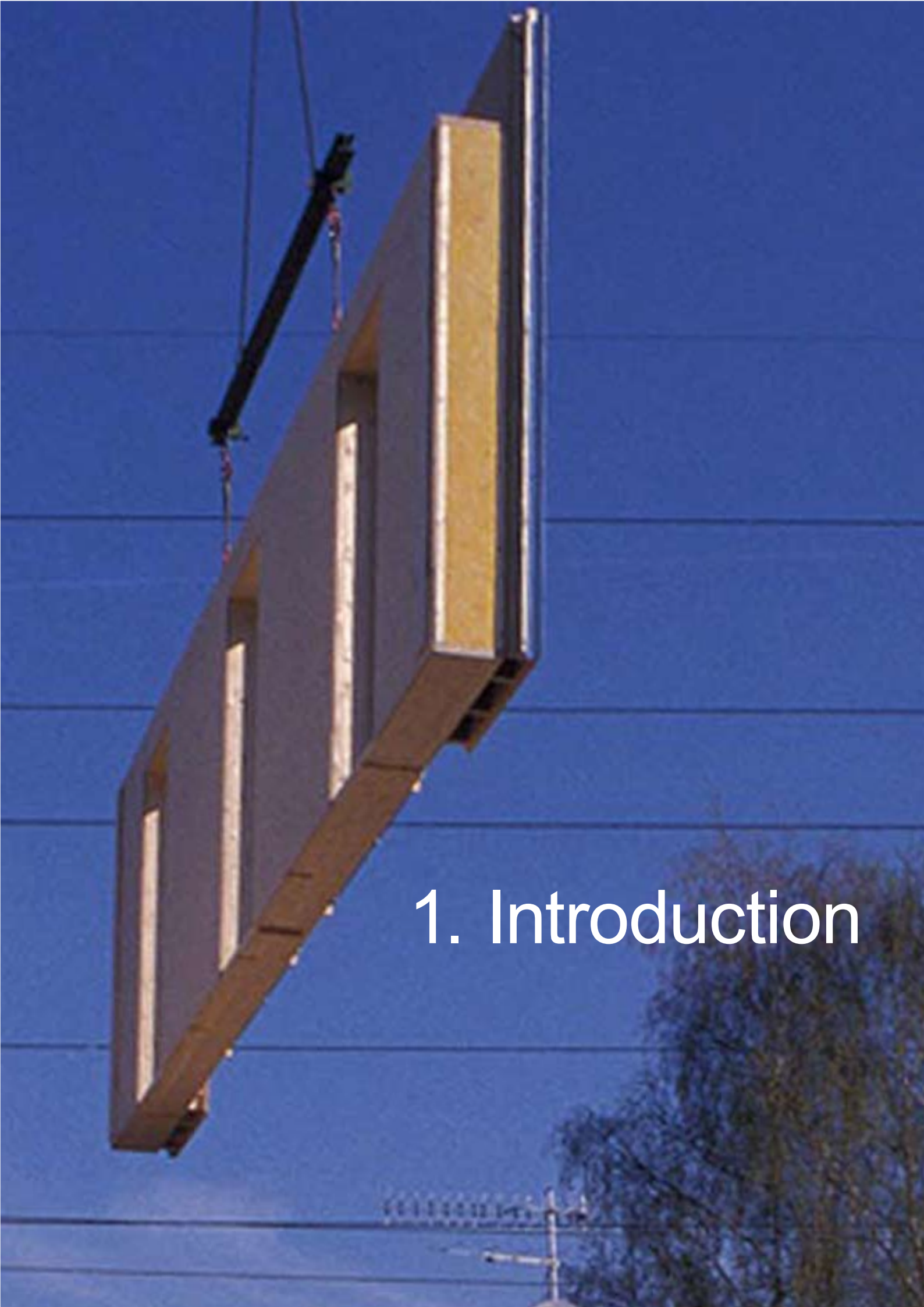

1. Introduction

1.1. Modernisation - the 2nd Chance for Architecture

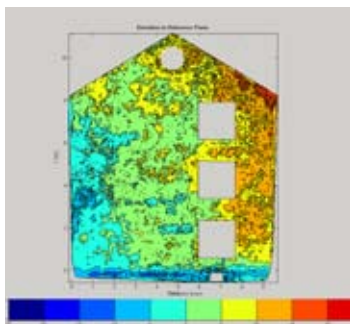

1. Modernisation workflow

TES EnergyFaçade is a systemised building method for the assembly of off-site fabricated customised timber façade panels, replacing either certain layers of, or the existing building envelope in its entirety. The basis for the use of prefabricated retrofit building elements is a systematic process of surveying, renovation planning, construction and maintenance of the building stock.

Modern methods for measuring (i.e. Photogrammetry and 3D laser scanning) generate precise data of the target buildings for 3D-models, which are used for designing prefabricated components for renovating, and finally, for maintenance. The dataflow matches the requirements of the digital process chain, from site measuring, planning to prefabrication.

TES elements combine a self-supporting structure with insulation infill and paneling, which can be made of a wide range of cladding materials (e.g. timber boards, timber panels, glass, aluminium etc.). High precision building components like windows are easy to integrate due to the modularity.

Retrofitting with customised TES elements can include:

- Energy efficient retrofitting of façades and roof
- Renewal or improvement of windows, modification of window openings,
- Extensions, annexes or the addition of spatial elements or balconies
- HVAC modernisation
- Integration of solar-active components and / or passive solar heating systems

Central characteristics of the TES method

Construction

- Self supporting timber frame structure
- Precision and quality of a customised prefabricated building system
- Application of a large variety of cladding materials
- Spatial intervention or modular expansion in a coherent system
- Integration of HVAC and solar-active components
- Integration of load bearing elements

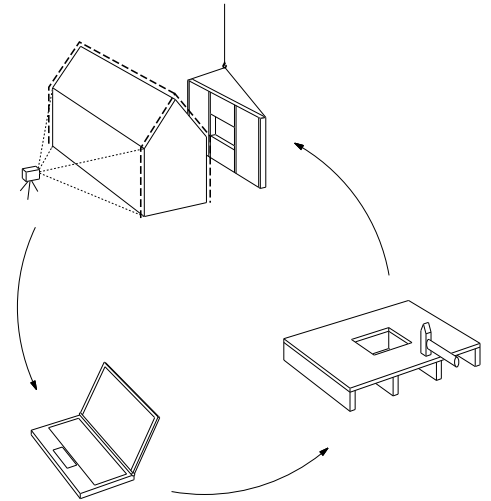

2. TES EnergyFaçade building method.

Values

- Architectural renewal
- Modification of façade materials and openings
- Improvement to the buildings energy efficiency and increased living comfort
- Ecology - use of timber based materials in façade elements
- On-site productivity
- Reduced construction time on-site = less noise and disturbance
- Maintenance oriented and end-of-life design utilising LCA methods
- Higher return on investment (ROI) through quality, holistic solutions and industrial productivity
- Product endorsing an ecological life-style of health and sustainability (LoHaS)

Knowledge

- Systemised workflow
- Digital survey using reverse engineering methods from project start
- Holistic planning process supported by BIM in design, realisation and maintenance

1. Characteristics of TES method

Task and potentials

Doubtless, the main task in Europe's construction activities in the future will be the renovation of the existing real estate stock with a strong focus on the ecological improvement of an energy efficient building envelope. The restriction of our energy resources will focus this need drastically. The urge to face up to the consequences of the climate change with the reduction of green house gases (GHG) has been underlined by the publication of the latest assessment report by the IPCC¹ in 2007.

Buildings are responsible for 40% of energy consumption and 36% of EU CO₂ emissions.² Energy efficient building modernisation contributes to the reduction of GHG emissions to a significant extent.

Resource efficiency is seen as another key factor in energy efficiency, since the construction sector is responsible for 40 % of EU material flows, as stated by the EU in the *Sustainable Consumption and Production and Sustainable Industrial Policy Action Plan*.³

Two strategies lead to possible solutions. The first relies on the safeguarding and reuse of existing buildings and structures. A second approach promotes a stronger use of renewable resources like timber, timber products and other biogenic building products in construction.

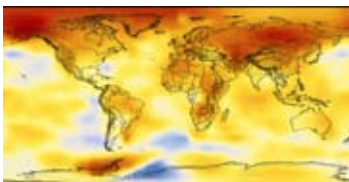

3. Global warming map, © by NASA.

1 IPCC, Forth Assessment Report, 2007

2 http://ec.europa.eu/energy/efficiency/buildings/buildings_en.htm, verified 28.05.2010

3 COM(2008) 397 final, Communication from the Commission to the European Parliament, The Council, The European Economic and Social Committee and the Committee of the Regions on the Sustainable Consumption and Production and Sustainable Industrial Policy Action Plan, <http://eur-lex.europa.eu/LexUriServ/LexUriServ.do?uri=CELEX:52008DC0397:EN:NOT>, verified 06.11.2009.

TES EnergyFaçade concentrates on the development of a customised building system using prefabricated timber framed elements including the integration of biogenic insulation materials and techniques, multiple glazing and HVAC components. “Realising these savings requires an integrated design process involving architects, engineers, contractors and clients, with full consideration of opportunities for passively reducing building energy demands. Over the whole building stock the largest portion of carbon savings by 2030 is in retrofitting existing buildings and replacing energy-using equipment due to the slow turnover of the stock (high agreement, much evidence).⁴”

Building modernisation as a holistic intervention offers a 2nd chance for architecture and urban renewal, including infill development. A great number of buildings in Europe built between 1950-1980 will in any case to be renovated within the next decade due to natural deterioration, technical, architectural and/or social aspects. With regards to this, the improvement of the envelope will offer major benefits to the building's energy consumption saving potential and a vital contribution to the reduction of the global CO₂ Stock.⁵

European wide, there is a particularly high backlog of energy efficient renovations to the insulation layer of the building envelopes, i.e. the exterior wall and roof structures. The wide spread and most common method is the improvement of the exterior wall through the application of external composite thermal insulation systems based mainly on mineral fibre or polystyrene foam - at the expense of a high outlay of primary energy for production. Their application is weather dependent (temperature above 5°C and dry conditions) and mounting becomes difficult with increasing thickness of the insulation layer.

The common renovation practice can be characterised as follows: craftsmanlike, non-ergonomic procedures, use of pollutive insulation and construction materials, tailoring and processing on site with high dust and noise emission, substantial off cuts and pollution, disturbance to the neighbourhood. The use of prefabricated systems and sustainable raw materials are minor exceptions to the rule.

The exploitation of features of modern digital based survey of buildings, transfer to CAD drawings and the prefabrication of large scale insulated elements is not a common practice.

A TES retrofit is approached as a holistic building modernisation including the improvement of a building's self sufficiency in energy production. This approach includes a dramatic reduction of heat and primary energy demand as well as the design and addition of energy productive elements, depending on local conditions.

Measures to reduce the heat and primary energy demand in combination with the building envelope include:

- Minimisation of thermal transmission losses
- Airtightness Construction
- Ventilation with a high heat recovery ratio
- Windows with low U values
- Integration of shading devices
- Integration of solar active components

The optimisation of the building envelope includes improving the insulation for

4 http://www.ipcc.ch/publications_and_data/ar4/wg3/en/ch6s6-es.html, verified 10.08.10, 14:00

5 Schulze-Darup B. (2004) Energetische Gebäudesanierung mit Faktor 10, Deutsche Bundesstiftung Umwelt, Osnabrück.

winter and summer, daylight use and the integration of technical features (HVAC, solar panels). A core task of energy efficient building design is to reach the required indoor environmental quality with a minimum of primary energy demand and a simple energy supply system.⁶

Improvement of Energy Efficiency / Energy efficiency as an architectural aspect

Town planning measures have been developed to increase the density of existing urban structures which can be achieved by adding roof floors, neighbourhood specific infill developments or extension of building spaces. In addition, the TES method for improving the energy efficiency of the building envelope completes the scope of *'Additions & Alterations'*. Modern timber construction offers a consistent compatible building system and a wide range of spatial and technical solutions, which can be applied to the different tasks. The architectural appearance of both buildings and built environment can be substantially improved by restructuring façades, exchanging façade materials, adding extensions, annexes or additional storeys. The geometry of the building may be modified by adjusting openings and integrating loggias or balconies to the heated living area. Aside from that, the existing built environment contains a cultural heritage which should be preserved for future generations. A retrofit method which can be affixed to the existing substance and that is possible to dismantle thanks to its modular concept offers new perspectives for cultural preservation. Annexes or extensions can be added to the building increasing the productive floor area.

Infill development with TES:

- | |
|---|
| 1. Additional storey |
| 2. Horizontal annex |
| 3. Infill of building volumes |
| 4. Replacement of / addition to building envelope |

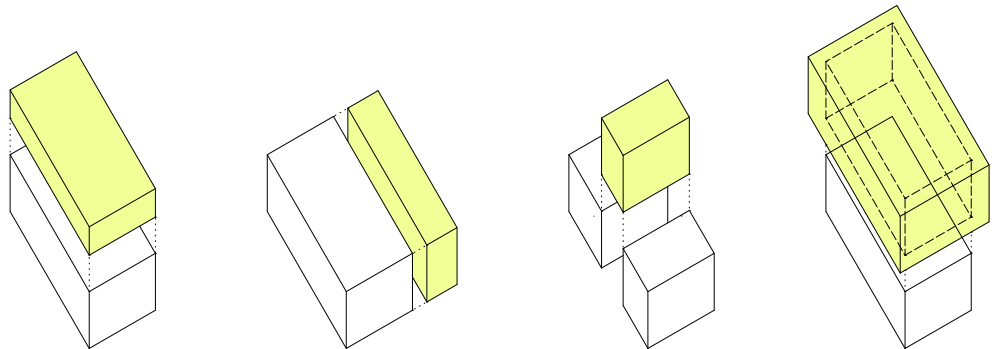

4. Possible interventions

Updating the building stock often require retrofitting strategies that not only improve the technical performance of a building but also adjust space and appearance and thus the architecture. These include the integration of technical systems, solar design and extensions or changes to the existing floor plan structure.

Use, function, technical services and appearance of the building stock often no longer meet today's demands and expectations of modern architecture. Social and cultural ways of living and housing have changed - brought about by developments in family structures, work-life balance and aging societies etc. - and demanded adapted solutions. The appearance and functional properties of the building stock

⁶ Hegger, Fuchs, Stark, Zeumer (2007) Energie Atlas, Institut für internationale Architektur-Dokumentation, München.

are the results of the visions and inventions of their time and their renewal needs comprise aspects. In many cases the building structure can be modified and extended and retrofitting becomes a smart alternative to total demolition and rebuilding. Schwanenstadt's school and the student apartments Neue Burse Wuppertal provide compelling examples.⁷

Particular interests

Owners demand convincing figures for marketing and calculating returns on the investment of the measure whereas tenants benefit from increased comfort and reduced heating energy costs.

The TES method based on the application of prefabricated customised large sized timber framed wall elements is a one-stop solution satisfying all modernisation requirements. Quality is ensured by the experience of the timber construction sector, providing a reliable system of timber framing technology and sustainable building materials.

The challenge of the task is not only the preservation of the existing building stock, cultural and architectural values but its metamorphosis as a response to future needs. Modifications offer the opportunity to add future oriented concepts and enduring cultural creation. Functional and constructive aspects can be remedied and the appearance modernised.

The improvement of the building envelope will be a major benefit to the structure's energy saving potential and a vital contribution to household reductions of total CO₂ emissions. In this context, timber building systems and biogenous building materials can be considered to have outstanding qualities due to their ecological properties⁸.



5. Schwanenstadt, Austria
School before and after modernisation; PAUAT Architekten, 2004

1.2. TES Method - Systemised Workflow

The TES method is a systemised modernisation process from survey, planning, production off-site to assembly on-site as a consistent structure along a digital based workflow. It provides the essential data and allows the integration from first sketch to the mounted façade. Planning, energy simulation and production design, based on BIM data, supports the control of the energetic performance and economic optimisation. Furthermore the holistic method allows the integration of multiple functions in one building system, due to the openness of TES method, one of its core concepts. Necessary responsibilities of all participants are set within the frictionless digital workflow as state of the art in survey, planning and production.

digital measurement – planning off-site fabrication – on-site assembly

Prefabrication demands detailed information on the renovation object. On the basis of an accurately measured building survey, customised TES elements are fabricated off-site according to the project specific design at the factory. These can include ready-assembled cladding, integrated window modules and, if necessary, interior surfaces.

A shorter assembly process on-site and fewer restrictions due to construction work compared to conventional renovation methods is an exceptionally valuable quality for owner-occupied flats or buildings under operation.



6. Risør College, Norway
Prefabricated façade elements with close boarding, assembled in 2009.

⁷ Schule Schwanenstadt, Austria; PAUAT Architekten; 2004; Neue Burse, Germany; Architektur Contor Müller Schlüter, 2000-2003.

⁸ Wegener et al. (2010) Bauen mit Holz = aktiver Klimaschutz, TUM Holzforschung München, München.

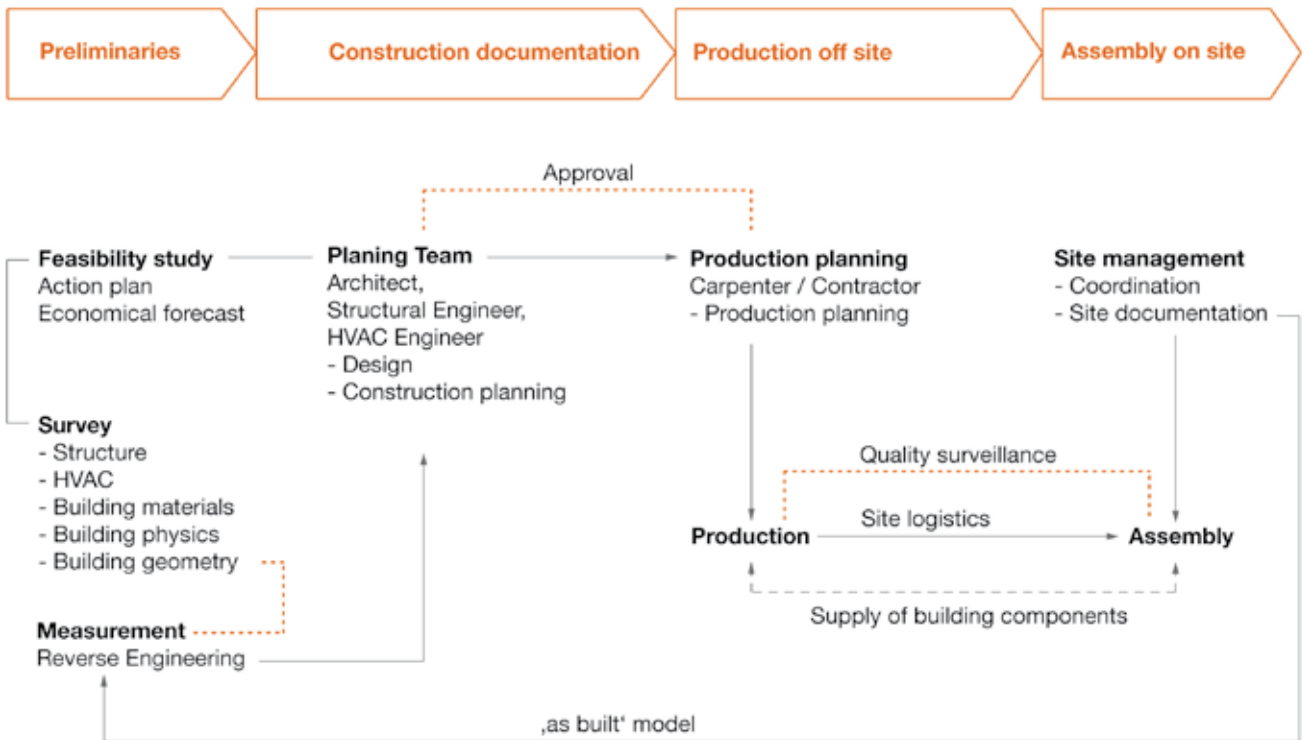

Characteristics of the TES method

Heating energy demand and green house gas emissions can effectively be reduced by thermal enhancement of the building envelope, i.e. improvement of airtightness and the reduction of heat transmission through the building skin. Outer walls count for up to 80 - 90% of assembly related heat energy saving potential, windows for around 50%.⁹

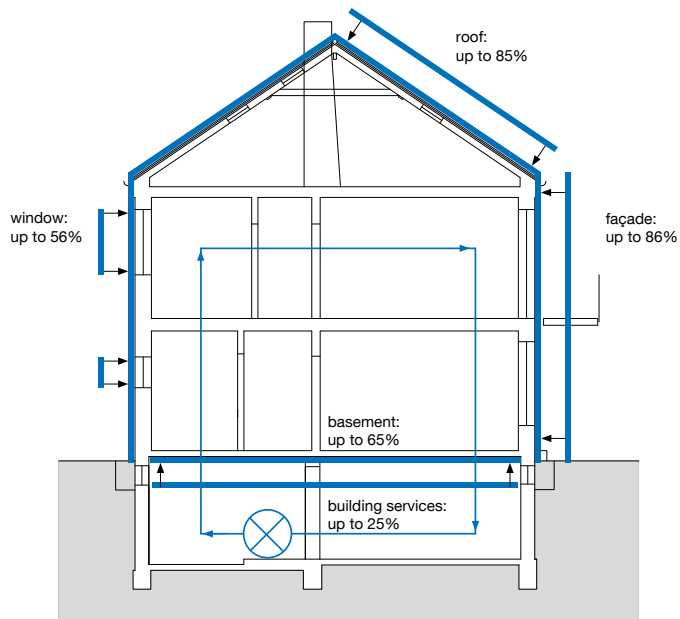

Reduction potential of heat loss in modernised buildings.
Source: IWU "Gebäudetypologie Bayern", Eberhard Hinz, 27.02.2006.

7. Retrofit interventions for energy efficiency.

⁹ Institut Wohnen und Umwelt (IWU) (ed.) (2006): Gebäudetypologie Bayern, Darmstadt, p. 15ff.



8. Prefabricated façade element assembly at Realschule Buchloe.

Prefabrication

In the timber construction sector, advanced methods of prefabrication¹⁰ are very successfully used in a contemporary fashion to produce and sell new energy efficient buildings, and are consistently gaining market share. Prefabrication allows the integration of building components such as windows, building services systems and ready-made surfaces of the façade elements in the controlled and ergonomic working environment of the factory. A flexible workflow from design to production allows for customised fabrication of single building parts, taking into account the specific needs of individual buildings, e.g. size, unevenness etc.

Digital Surveying - Reverse Engineering

Combining the conditions of an existing object with new adapted and industrially manufactured parts leads to the paradigm of reverse engineering (RE). RE is described as the concept of planning and production of parts based on a digital model derived from digital imaging results which are taken from a physical object. Survey methods applied are photogrammetry, tachymetry and/or 3D laser scanning.

Digital Workflow

Planning methods are based on CAD/CAM models for production, integrating the results of RE. The high accuracy and the control over data integrity is backed-up by a digital workflow. Building information modelling as a tool integrates all information and supports the planning, construction and maintenance process. Lastly the digital workflow ensures the stencil like fit of the new TES elements onto the existing façade.

On-site Productivity

The builder will be able to achieve higher work productivity for the whole process and especially the mounting phase. Supply processes for elements can be optimised in the workshop, e.g. material flow and efficiency, machine employment, etc.. The work load on-site is minimised to the handling of just-in-time provided parts. This avoids organisational work, unproductive time, preparation work and enhances the productivity on-site substantially.

Architectural Renewal

The use, function, technical services and appearance of the building stock often no longer meet today's demands and expectations of modern architecture. Building modernisation becomes the 2nd chance for architecture, improving the technical performance of a building, adjusting space and appearance. TES EnergyFaçade includes the integration of technical systems, solar design and solutions for extensions or changes to the existing layout. The timber frame structure provides a certain load bearing capacity, allowing the application of different surface and cladding materials.

10 Kolb, Josef (2007) Holzbau mit System, Birkhäuser, Basel.

Ecology

The target of the TES method is primarily focused on the building's energy efficiency improvement and as a consequence in the reduction of GHG emissions. Every activity in construction is responsible for the consumption of additional resources in the form of raw materials or energy and therefore cause emissions. A possible solution to this dilemma is the adoption of a sustainable and ecological retrofit method based preferably on biogenic materials.

The theoretical model of a sustainable development path for the global society was offered by the Brundtland commission report "Our Common Future" and is based on the vision of a conscious style of consumption in order to preserve a high standard of living for future generations.

The European Committee for Standardisation defined a first standard for sustainability in construction, the prEN 15643¹¹. Providing a holistic view of the entire life of a construction "product", it evaluates ecology, economy and society related qualities as equivalents, which have to be recovered.

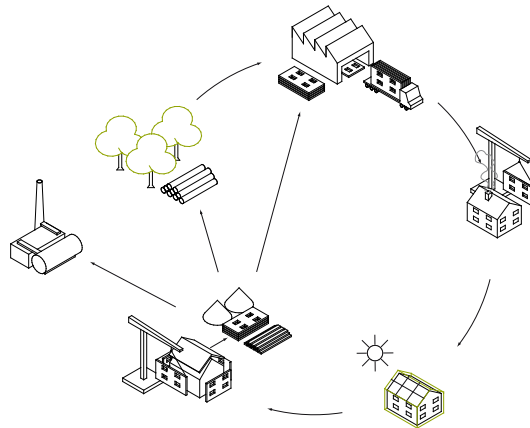

9. Simplified lifecycle model of a TES EnergyFaçade retrofit.

Life Cycle in Retrofit Projects

A life cycle concept covers the optimisation of the overall performance of a building from "cradle to grave". The performance is documented and evaluated according to the criteria of the standard prEN 15643 standards. The life cycle is separated into four phases in building life:

- Product phase (production of construction materials and assemblies)
- Construction phase (erection or retrofit of a building)
- Operation phase (use as long as the functional requirements are fulfilled)
- Disposal and recycling phase (partly or total demolition when technical requirements are no longer economically viable)

There are approved concepts for excellent energy-efficient houses like the *passive house* as well as plus energy houses, as shown in the *Solar Decathlon* competition. The construction industry accounts for the highest material flows of all economic sectors in the EU. Every action in construction causes enormous waste streams. However the focus now has to be on the product phase, how to bring

11 prEN 15643:2009: Sustainability of construction works. Assessment of buildings.

forward the realisation of innovative concepts in the most effective and sustainable way. Durable, fully recyclable or reusable and safe products are needed for energy and resource efficient houses whether new building or retrofit.

Timber Based Materials

Against the background of essential climate change action, energy and resource efficient use of building materials plays a vital role. Timber and timber based building materials gain added importance due to their positive primary energy demand from cradle to grave and carbon-footprints.¹² Advanced planning tools and construction methods, based on the thorough experience of the timber construction sector open the door to sophisticated timber construction systems for building modernisation.

Maintenance and End-of-Life Design

TES EnergyFaçade is a retrofit system which prolongs an existing building's life and improves its technical and functional properties. The conditioning of retrofit products has to be considered from a life cycle point of view, as one of the commandments of sustainability and as the input of new material or the disposal of waste building material is costly. Every retrofit solution has an end-of-life caused by normal deterioration and more efficient and alternative retrofit interventions. End-of-Life design concerns waste management and recycling solutions for end-of-life of TES EnergyFaçade.

During building operation – the longest phase in a building's life – the main interest is life cycle costing. The cumulation of all costs over the structure's operational life, for regular cleaning, repair and running a facility, can by far exceed the investment. Experience from research projects reflect the high level of life cycle costs. Maintenance and repair are big issues for climate exposed building envelopes. Therefore an individually planned solution helps to avoid the risks of high operational costs. An apparently cheap solution can lead to high life cycle costs exceeding those of the investment. On the other hand, a higher investment in an upgrade solution will in most cases create lower life cycle costs.

Sustainable Economy (Return on Investment)

The basic concept of sustainable economy is the limit of natural resources. Improved building envelopes are a basic condition for the substantial reduction of the energy demand in housing. Consequently the insulation methods of buildings have to be considered carefully in respect of resource saving. Currently available methods are largely based on non-renewable resources as well as consuming a large amount of energy and causing air pollution during production and disposal. A less resource-consuming substitute is needed which is both more ecological and provides other positive aspects of sustainability. The TES EnergyFaçade method provides these future oriented features as well as providing added value. TES materials are based on renewable resources mainly from timber and the installation method minimises the disturbance of inhabitants during construction work.

Sustainable economy requires lifecycle observation and a long-term preservation of resources instead of an optimal consumption of them. Therefore economic calculations have to take the entire building life into consideration.

In lifecycle observation the minimisation of life cycle costs for the operation of the building are essential. They are kept low by the good thermal insulation of the building envelope. Another important issue is the durability of facade system providing shelter, functionality and thermal insulation of the envelope.

From an economic point of view the conservation of existing asset give positive values, because the resources stored in the asset are kept and reused. The future development of the value of the asset should be secured due to its sustainable profile and low operation costs.

Quality

A quality retrofitted project is a conservation of values or an added value. A satisfactory result can only be achieved if a QA system covers the entire life-span - from the process of retrofitting to the management and maintenance of the operational phase of the building. The overall objective is to ascertain that all predefined requirements will be reached and that the building as a system of envelope and interior conditioned space will solve the needs of its users and the expectations of the client.

Contractors (e.g. carpenters) would not be able to achieve a high quality standard if they were the only ones responsible for the building process. Planning and project organisation have a significant effect on the outcome. Therefore all participants in the building process have to be involved in quality assurance measures throughout all phases. Quality standards are well-established in the timber industry.

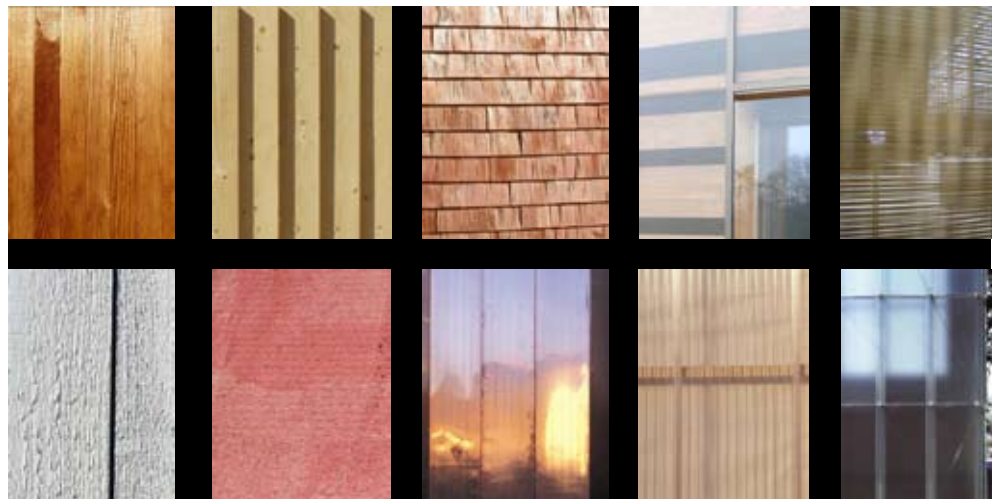

10. Wide variety of surface solutions for TES.

Lifestyle Product - Business Model

Private customers today are more interested in ecology, health and sustainability of industrial products than in earlier times. Firms are also more conscious of corporate social responsibility and may therefore include real estate in their strategic decision-making by investing in environmentally-labelled buildings. As a result a range of less polluting and energy saving techniques, using renewable resources, can be identified. The holistic concept of TES aims at least at a balance of these customer interests. Hence they combine a modern and high quality retrofitting method and an innovative product with sound ecological, economic and social or cultural values.

Pro-active entrepreneurs in the timber sector have the chance to adopt the process and extend their portfolio with sustainable renovation products. Possible models are the *original equipment manufacture* (OEM) with production lines for raw façade elements. Another model may be the *integrator* using OEM products and integrating additional features. Further there are traditional *reseller* or *assembler* business models.

Of course it is also possible to invent additional business models providing service agreements for maintenance, repair, warranty and recycling businesses. For example costly disposal solutions can be separated out by a taking back or recycling guarantee from the carpenter.

Finally a futuristic vision may be the combination of energy contracting, emissions trading or emissions credit and compensation system integrated in holistic retrofit solutions.



2. Building Stock

2. Building Stock

Throughout Europe there is no comprehensive data regarding exact figures of building typology, number, age and status.

In order to evaluate the demand and potential of necessary building modernisation, our approach is based on available national and regional data resources from research reports on the building stock. Whereas in Finland and Norway these figures are rather incomplete, in Germany most comprehensive data is provided by the *Institut Wohnen und Umwelt (IWU)*, Darmstadt, Germany. Their data is especially generated for the purpose of evaluating the energy saving potential of the building stock. The number of the type of buildings in the relevant building age classes and their actual condition is the most essential characteristic of this data. It clearly shows the economic potential according to energy savings and the available façade area for renovation. The following details are considered as an essential summary for the target group of buildings preferred for the TES method.

Building Age Classes

Building Age Classes

are an instrument of statistical classification of the building stock. They cluster existing buildings according to their distinct building methods and construction types into coherent time sections. The time span for a class is defined with reference to technological changes in building and construction sector, new regulations (e.g. energy saving regulations) or historical breaks (war).

A statistical classification for the building stock in Germany is clustering buildings in age classes, grouping existing buildings due to their distinct building methods and construction types. The time span for a class is defined according to changes in building and construction (building industry), new regulations (e.g. heating energy demand) or historical breaks (war). Data is provided on the number of different building types per class, condition, energetic standard, building method as well as preferred construction materials.

The following figures¹ show the range of residential buildings specified by age and quantity. Buildings of the time span from the 1950s to the early 1980s constitute nearly 50 % of the German building stock and account for around 8.5 million units. This amount illustrates the reduction potential of energy demand, as these buildings consume between 150 and 250 kWh/m²a in their unrefurbished status. As the urge for comprehensive retrofitting of the entire building stock is evident and generally recognised, we have not concentrated in further specification of diverse stock figures.

¹ Destatis (2006), Mikrozensus-Zusatzerhebung 2006 - Bestand und Struktur der Wohneinheiten - Fachserie 5 Heft 1

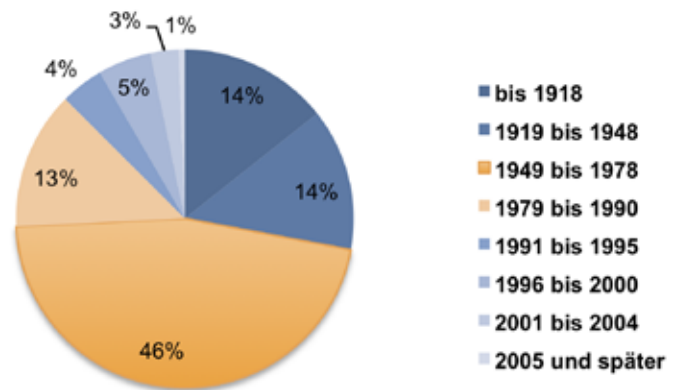

11. Residential units by building age class, Germany.

Three building age classes between 1950 and 1980 exemplify the development and major changes in urbanism, typology and construction which are defined in the German context.

1950s

Urbanism	Developments with low density, open and green spaces nearby or inside the city centre.
Typology	Multi-storey dwellings up to 5 or 6 levels with interior staircase and seldom with arcade.
Construction	Load bearing masonry walls with punctuated façades and concrete floor slabs. Façades are designed calm and smooth, balconies are rare.
Deficiencies	Preferred building material after the war: reused bricks, poor quality concrete and plaster with insufficient aggregate. Windows, wood framed without sealing and double-glazed casements, most of which have been replaced since the 1980s with PVC framed, insulated glass windows.
Weakness	No insulation of the envelope, floor slabs tailed in thin outer walls, window joints in offset reveals, low U-value of window construction, poor roof construction without any insulation.

1960s

Urbanism	Densified large development areas, closed spaces, located in outskirts.
Typology	Medium to large scale housing complexes, apartments with large floor space.
Construction	Simple compound or monolithic structures, intensified use of concrete, large façade openings, structured façades and additional loggias and balconies. Availability of industrial façade systems, timber and metal window frames with single glazing.
Shortages	Poor building and construction standards, low quality construction.

Weakness	Façade openings and construction, missing insulation layer.
1970	
Urbanism	High density, large development areas with green spaces.
Typology	High-rise buildings, large-scale housing complexes, smaller floor area.
Construction	Intensively prefabricated, structurally optimised, high quality concrete structures, concrete skeleton frames. Layered and structured façades, façade cladding and curtain wall façades with material mix or sandwich construction, single layer glazing.
Deficiencies	Poor building standards and construction related to building physics, leaking joints, technical defects of façades, problems of mass production and material quality, economy of materials.
Weakness	Missing or minimized insulation, massive thermal bridges by cantilevering building parts in façades, poor energetic quality of façades and windows.

Building Type and Size

A successful economical retrofit with TES elements is suitable for buildings of a particular size and volume as well as a rational façade layout. Suitable building types may be office buildings, public buildings (schools etc.) or apartment buildings (multiple dwelling). The area of the building envelope as well as a regular and almost repetitive façade design are decisive advantages.



12. Typical apartment houses of the post war era.

Relevant types of houses in multistorey dwellings:

- Divided dwelling types (double, triple, quadruple dwellings) with a decentralised staircase in front of or close to the outer wall (typical in row houses or in downtown slab block structures).
- Point blocks with central staircases mostly inside the core of the building with 4-8 residential units per level (solitary buildings in urban fabric).
- Special types with a central staircase are staggered plans with triple or quadruple dwellings in order to enlarge daylight input. (solitary or terraced house).
- Outdoor corridor types with decentralized staircases and floor wise, external horizontal access corridor (terraced houses, seldom solitary).
- Terraced- /stepped houses with central or decentralised staircase and optional horizontal access corridor (solitary).

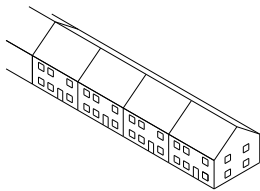

01_02 terraced houses

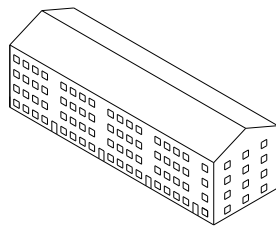

01_03 row house

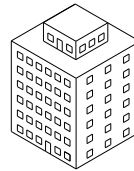

01_04 point house

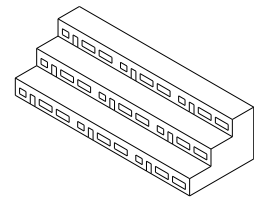

01_05 stepped house

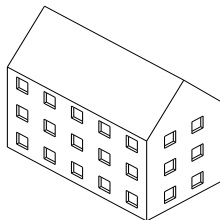

02_01 shear wall

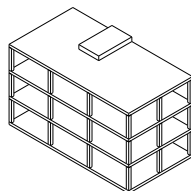

02_02 skeleton

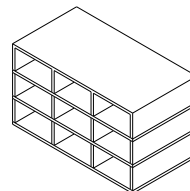

02_03 crosswall

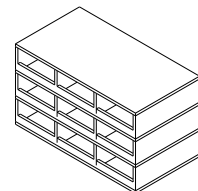

02_04 crosswall-ribbon window

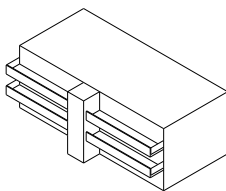

03_01 exterior access

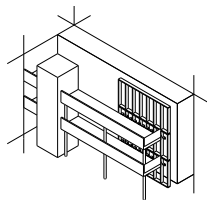

partly demolition of exterior access support and new facade layer

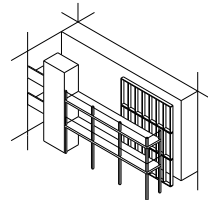

new built exterior access in front of new facade layer

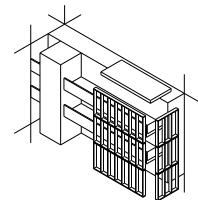

new facade layer enclosures the exterior access

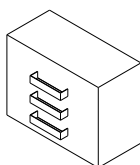

03_02 existing situation cantilevering balcony, balcony demolition

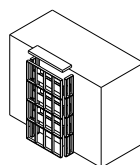

balcony enclosure

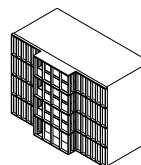

balcony enclosure and new facade layer

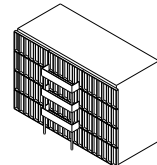

new facade layer and addition of new balcony

13. Typology of relevant building types.

14. Typological floor plans with corridor houses and terraced houses (from left t. r.): acc. to Neufert, 1973.

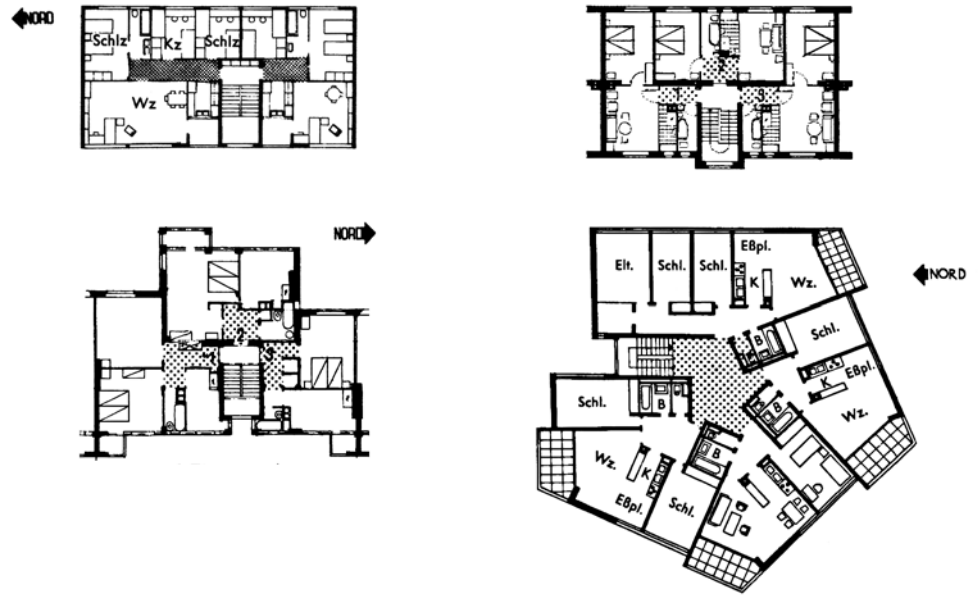

15. Typological floor plans with centralised access (from left t. r.): double dwelling, triple dwelling, staggered dwelling, Point block, acc. t. Neufert, 1973.

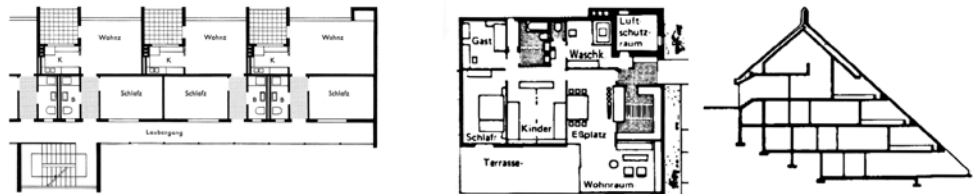

16. Examples of German dwellings from the 60s and 70s in Nuremberg.

2.1. Energy Efficiency in Building Stock

The building stock in the EU accounts for up to 40% of the final energy demand used for heating our houses. Reduction of this energy demand is the most complex and challenging, but also the most promising contribution to the climate saving efforts. There is a high potential to reduce the energy demand of buildings from the 1950's to the early 1980's. Since the 1980s the first energy efficiency regulations came into effect.

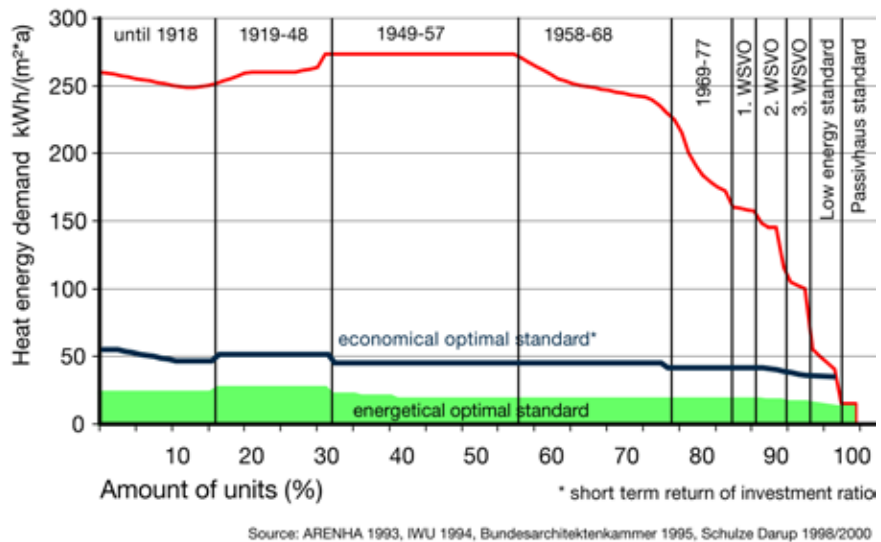

17. Building stock clustered in building age classes and its specific heat energy demand.

The main reasons for the high energy demand are poor constructions with high rates of transmission heat loss, ventilation heat loss and inefficient building services systems. The causes are the very poor construction standards of the post war era, followed by a deficient insulation quality of mass produced large-scale dwellings in social housing programmes in the late 60s and in the 70s. These industrialised fabricated buildings - found all over Europe - face the problem of often thin, permeable walls, bad window solutions and problematic construction joints and almost no heat insulation. This results in an immense heating energy demand in the range of 150 – 250 kilowatt-hours per square meter and year (kWh/m²a) compared to 50 kWh/m²a prescribed for a low-energy building.²

	1. WSchVO 1977, k-values [W/m²K]	EnEV 2009, U-values [W/m²K]	“Passivhaus” new building
Windows (glazing)	3,0	1,3 (1,1)	0,8 (0,65)
Walls	0,78 (A/V > 1,2) -1,4 (A/V < 0,24)	0,24	≤ 0,15
Roof (flat)	< 0,45	0,24 (0,2)	0,12 (0,1)
Basement floor	< 0,8	0,3	≤ 0,15

2. Table: German thermal protection regulations compared to „Passivhaus“ rules.

² EnEV 2009 was introduced on 1.10.2009. Main cornerstones include a 30 % reduced heating energy demand compared to EnEV 2007 and 30 % lower U-values

A forceful reduction of the heating energy demand and the improvement of living comfort affects the building services technology. Smaller, more efficient heating devices or even a change of the entire heating system for a dwelling will be necessary. Heating systems for multi-storey buildings of the 50s - 70s generate too much energy, they are inefficient and technically out-of-date.

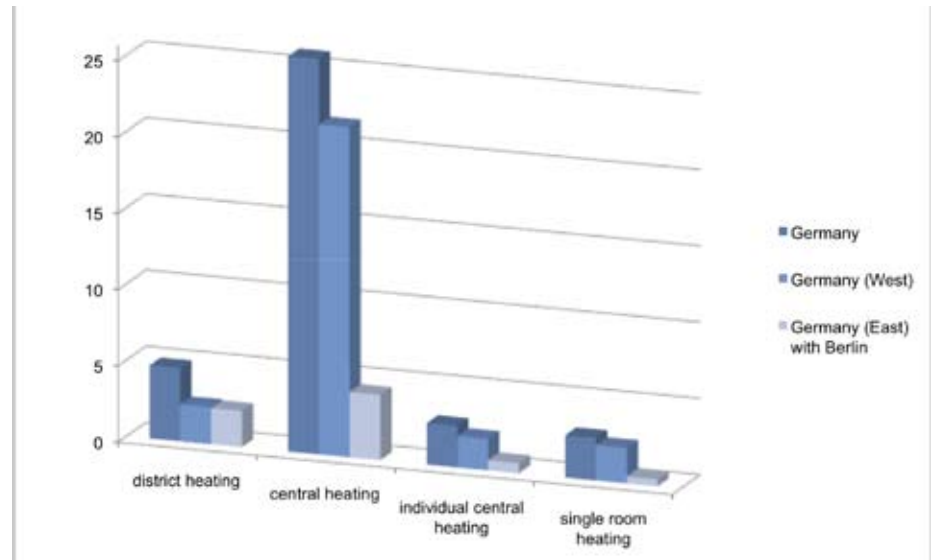

18. Type of heating system in residential units in millions.

Changing an energy supply system (heating, ventilation) is a major intervention into the spacial structure of a building. It necessitates a lot of construction work inside the apartments causing disturbance stress for people living or working there.

Thus, intelligent solutions for innovative heating technology in all fields, capturing, storage and distribution are on demand. With innovation in façade renovation the new envelope products can provide a platform for integrating the distribution into the new façade layer e.g. with routing outside the flat minimising interventions on the inside.

Indeed meeting today's legal standards for a retrofitted building requires little architectural, technical, economical and energetic effort. A more challenging objective is a factor 10 reduction - which stands for the paradigm of the *Passive-House*.³ After the Passivhaus was well and thoroughly tested in new building there have been several examples of renovations of existing buildings over the last 8 years.⁴ Reaching the standards of a *Passive-house* and its main objective, a minimised heat energy demand of 15 kWh/m²a heat energy demand, needs a set of actions attuned to the individual situation. Limiting design parameters like the orientation or the A/V ratio are pretended in a close range. Reaching the objectives is only possible by considering the full sum of interventions. Every one of them, from heat transmission to *Passive-house* suited building services systems, has to be optimised closely in relation to each other.

³ Passivhaus Institut, <http://www.passiv.de>, verified 06.11.2009.

⁴ Schulze-Darup (ed.) (2008) Energetische Gebäudesanierung mit Faktor 10, Deutsche Bundesstiftung Umwelt (DBU) research report series, Osnabrück.

2.2. Resource Efficiency in Building Stock

A renovation project concerns enormous flows of material from the recycling of existing construction material to the new material needed for renovation with consequences for economically motivated decisions during the renovation process.

There is a need to consider all forms of energy in the built-environment whether in the erection phase or during the operational phase. The latter normally greatly exceeds the energy demand of the former. This aspect has to be considered carefully, because the relationship of the embodied energy and the energy used for heating is changed with a high rate. In addition the amount of embodied energy incorporated in construction material is relatively high, especially in oil- or mineral-based materials, compared to such as from renewable resources. Construction material with a high energy potential dominates the market.

Accordingly the refurbishment of usable material, generally the building's structure, is a necessary step to prolong the life span of a building and save the energy embodied in the materials of existing buildings. Other building parts, with an interface role, such as façades, are more difficult to preserve or have to be massively improved.

Of course the most important contribution to life cycle impact categories come from reused structural building parts, which account for about one third (e.g. floors, walls) of the impact.⁵ Eco balancing or life cycle analysis can identify vital aspects and assists decision on strategies for optimization the ecological impact of renovation projects.

A common alternative to renovation is demolition. Arguments are often made, claiming higher cost efficiency or economic advantages for a new building. The opposite is in fact true as highlighted for example in school renovations in Schleswig–Holstein, Germany.⁶ Moreover additional costs for new building are generated as side effects, such as temporary buildings, rent for the substitution of spaces and higher operational costs during the construction phase. In addition there are considerable high fixed costs for demolition and disposal of the old building.

To this end it can be concluded that the life cycle of a building is another influential lever to preserve resources for future generations. Compared to consumer products buildings have very long operational phases and often host different usages over their whole product life.

In summary:

- Resource efficient modernisation and renovation of the building stock is recycling at lowest energetic levels and reduction of carbon dioxide emissions.
- Costs for renovation are cheaper in most cases than demolition, especially when additional costs for new building on the same site raise the total budget.
- Economic decisions need a thorough analysis of all data related to different renovation scenarios at an early stage, when conceptual influence has the highest impact on project costs.

⁵ SIA D0200 (2004) SNARC, Systematik zur Beurteilung der Nachhaltigkeit von Architekturprojekten für den Bereich Umwelt, Zürich.

⁶ Fechner O. (2009) Einsatz von Holzbau-elementen zur energetischen Gebäudesanierung öffentlicher Nichtwohnungsbauten in: Proceedings Timber Construction NordBau 2009, Lübeck.

Balancing Resources

A closer look at lifecycle shows another key issue when talking about existing buildings. Around half of the building stock has reached half of its predicted lifetime or even less. The average lifecycle, for example of rendered masonry façades with structural requirements, is up to 120 years according to the guideline of the BBR.⁷ The proper conservation of these buildings will be a major task. The result of retrofit therefore will be of much higher technical quality and will increase the value of the asset.

Together with an energetic enhancement of the building skin a modernisation will cause higher costs compared to a simple colour renovation. One advantage in renovating existing building stock is the resource efficiency of reusing building materials and whole buildings. The material balance and the resulting energy balance for construction material will be raised by additional insulation material of the building envelope. The resource balance of a project after a sensitive retrofit can be more beneficial than that of a new build energy efficient building. The relation between the existing material stock and the additional TES layer are a topic of the forthcoming SmartTES research project.⁸

Building Skin and Energy Consumption

The improvement of the building envelope is one of the most important parameters in the reduction of heat loss in a building. The improvement of airtightness and the reduction of heat transmission through the building skin is able to drastically reduce energy demand. The energy saving potential for buildings of high energy consumption is up to 80 - 90% for the outer walls and around 50% for windows.⁹

Renovation of the façade with TES improves the building and prolongs its lifecycle. The new skin provides technical functionality and ensures shelter and weather protection for the structural parts of the building.

The following systemised overview explains the main elements of the building envelope and compares the requirements within the retrofitting context.

7 BBR (ed.) (2001) Leitfaden Nachhaltiges Bauen, Bonn. http://www.nachhaltigesbauen.de/fileadmin/pdf/PDF_Leitfaden_Nachhaltiges_Bauen/Leitfaden.pdf, verified 20.10.2010.

8 SmartTES, Innovation in building construction for the building modernisation. Funded by Woodwidsom-Net 2. Project duration 10/2010 – 10/2013.

9 IWU (ed.) (2006): Gebäudetypologie Bayern, Darmstadt. p.15ff.

2.3. Systemisation

Monolithic structure

Skeleton

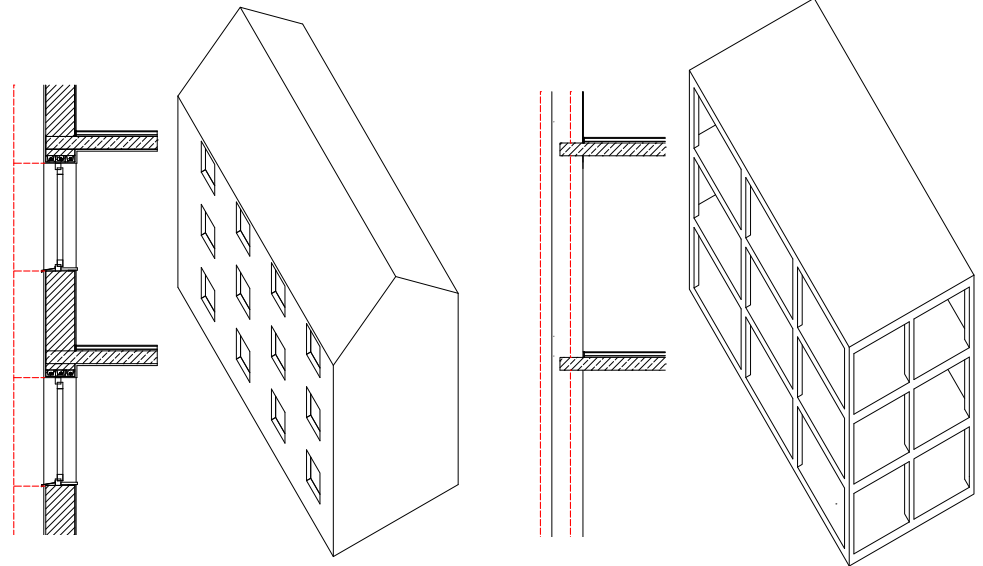

19. Load bearing outer walls versus a skeleton structure with infill.

Load bearing structure	Load bearing building envelope	Columns, beams and slabs
Survey	<ul style="list-style-type: none"> • Precise measurement of openings • Small tolerances for large TES elements - higher effort 	<ul style="list-style-type: none"> • Survey of ceiling edges and columns • Higher tolerances + smaller effort
Construction	Wall: monolithic - brick or concrete Ceiling: concrete or pre-cast concrete	Columns, ceilings and panels in one material only (concrete, steel or timber) or mixed structure
Intervention	Preservation of existing envelope. Change or enlargement of windows and doors in the exterior wall + Modification of buildings under operation possible	Part or total demolition of building envelope. <ul style="list-style-type: none"> - Cost for disposal - Interference with building operation
Mounting	Vertical load on foundation or anchor. Anchoring to ceiling front side (dowel)	Vertical load on foundation or anchor. Storey wise position on ceiling edges.

Design and space Enlargement of openings by demolition of sill possible, to the side and height high effort Wide range of creative possibilities for façade design

2.3.1. Building Geometry

Systematic overview of standard geometrical situations as a basis for the application of TES elements.

Roof

- pitched
- flat

Ceiling / balcony

- Balcony
- Loggia
- Access balcony

Window / door

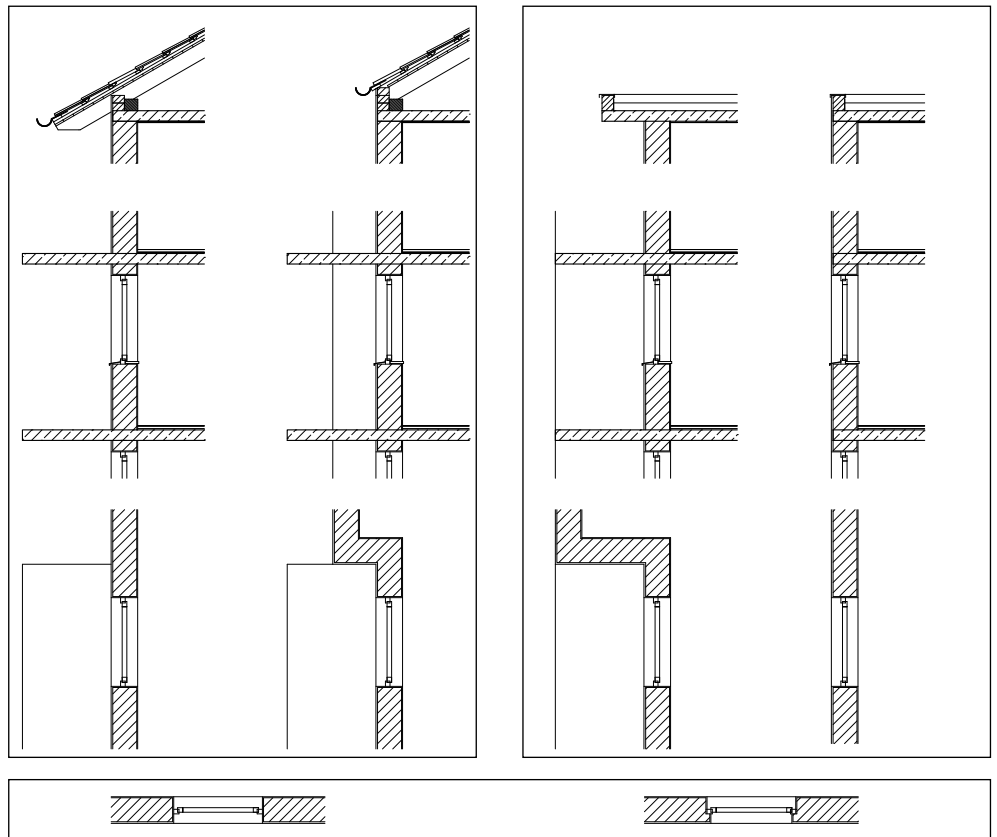

Wall

- Corner
- Surface
- Joints

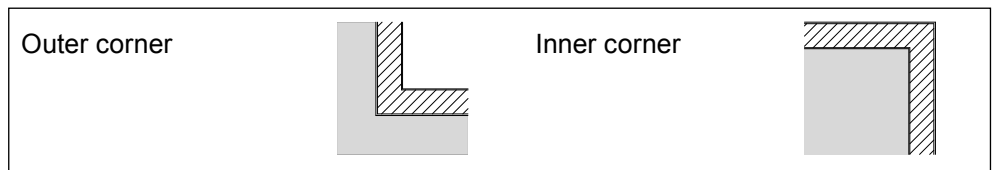

Foundation

- Basement heated / not heated
- Ground slab cantilevering

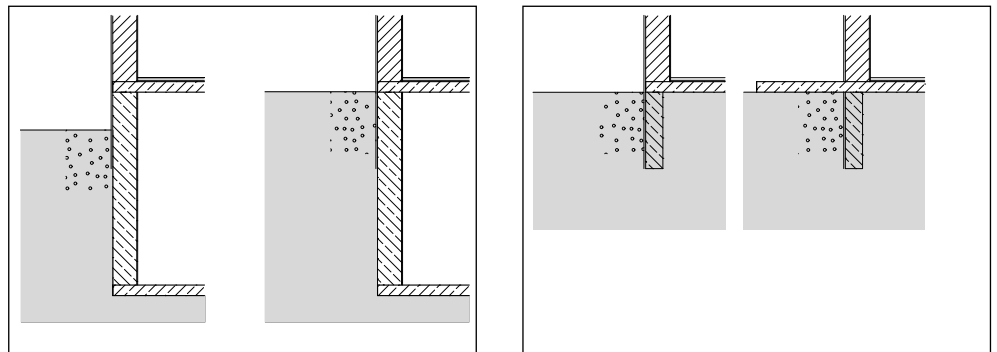

2.3.2. Foundation

Foundations secure the stability of a building and transport the structural loads to the ground. Ground stability and load reserves must be checked in the planning stage. Foundation, slab and base are building elements with earth contact. The base (30-50 cm off ground) is especially exposed to mechanical forces and moisture. Particular protection measures against soaking have to be taken (e.g. DIN 18195).¹⁰

Basement wall:

- Reinforced concrete
- Tamped concrete
- Concrete masonry
- Brick masonry

U-Values (EnEV 2009):

Earth touching: $U_{aw} < 0,35 \text{ W/m}^2\text{K}$

Regular: $U_{aw} < 0,28 \text{ W/m}^2\text{K}$

Element	Formation	Requirement
Foundation	Single foundation	
	Strip foundation	
	Slab	
Basement	heated	Insulation of exterior wall from inside and/or outside
	unheated	Insulation of base and cellar ceiling
Ground slab	cantilevered	Avoid heat bridge
Base		spray-water and moisture protection
Ground floor	at ground level	
	raised	
Flanking elements	light shaft	
	cellar window	



20. Base with cellar window

Cellar window - Ceiling - Terrain

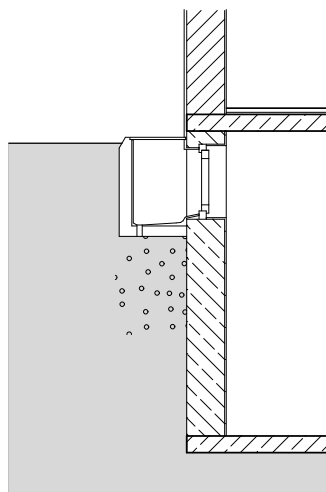

21. Window and light shaft, DH Weissenseestraße, Augsburg



¹⁰ Riedel W., Oberhaus H., Frössel F., Haegele W. (2007) Wärmedämm-Verbundsysteme, Fraunhofer IRB Verlag.

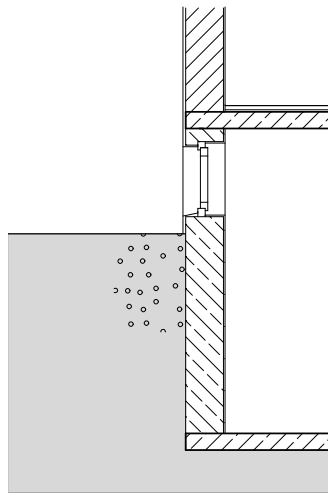

22. Raised ground floor, MFH Hinterbärenbadstraße , München

Terrain

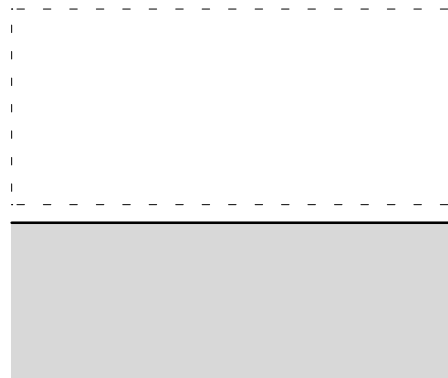

23. Flat terrain.

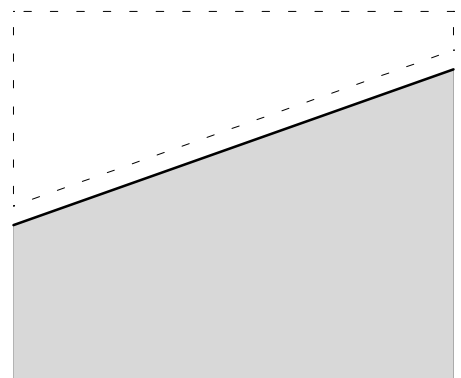

24. Tilted terrain.

Horizontal

Linear connection of the orthogonal
TES Elements
Simple position of bearings

Slope

Angular fitting element
Effort to position bearings

Concept for TES Element

Requirement	Feature	Detail
Load bearing base	Fixation to existing structure	Bracket Cantilever arm
	Free standing	Separate foundation and horizontal load bearing
Moisture protection	Sealing	Vertical sealing (DIN 18 195)
	Drainage	Wall protector Drainage
Cladding	Ventilation space	Air inlet
	Spray water protection	Base height > 30 cm
		Base height > 15 cm, e.g. gravel strip
		Base height < 15 cm, e.g. gutter
		Weather proof material
Replaceable		

Load bearing base

25. Separate foundation

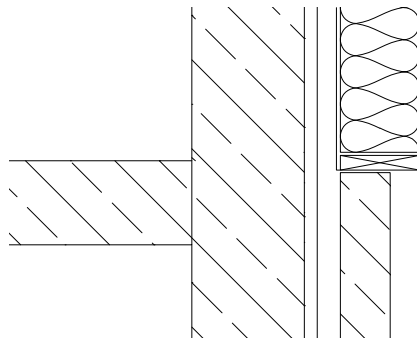

26. Bracket at ceiling edge

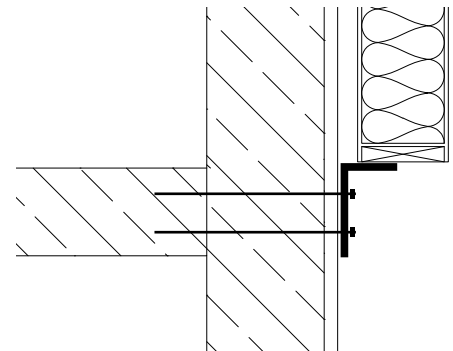

27. Fixation of brackets, Realschule Buchloe, 08/2009

Boundary line

Following diagrams show the ideal boundary line between warm and cold spaces in order to minimise transmission losses through heat bridges.

— ideal boundary line
warm / cold

Cold cellar

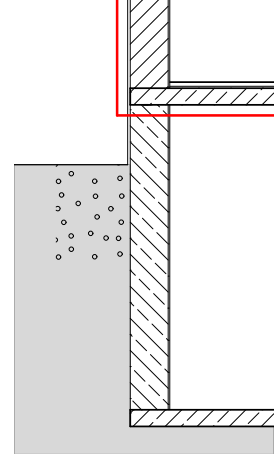
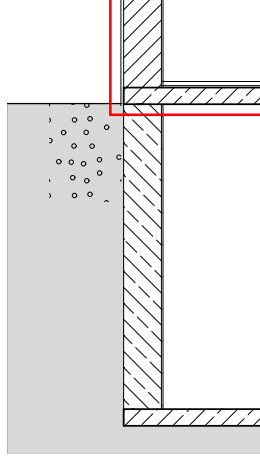

Heated cellar

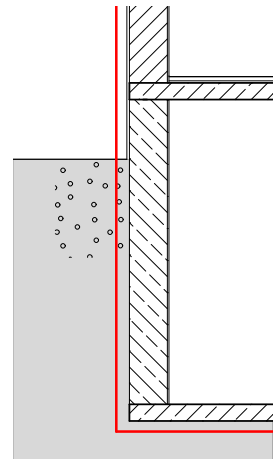
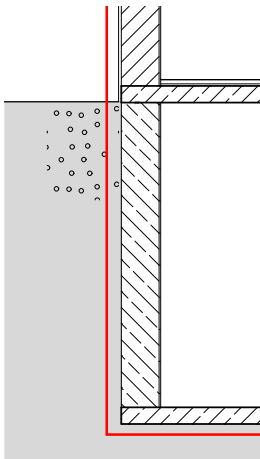

Base on ground

- Earth contact of timber elements
- Sealing base of TES element necessary

Base off ground

- + Load bearing base: bracket at ceiling edge
- + Separation of timber elements and basement insulation (ground contact)

Slab on ground

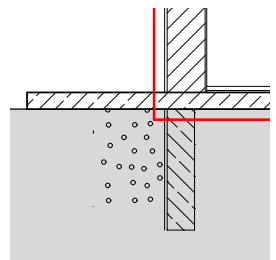
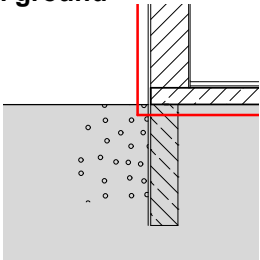

Base

- Ground contact of timber element

Cantilevering slab

- Heat bridge
- Ground contact of timber element

2.3.3. Exterior Wall

Exterior wall:

- Reinforced concrete
- Concrete or brick masonry
- Structural glazing
- Sandwich construction

U-Values (EnEV 2009):

U = 0,28 W/m²K (heated > 19°C)

U = 0,35 W/m²K (heated 12 - 19°C)

The exterior wall is the boundary between interior and exterior climates and consists of load-bearing, insulation and protection layers, applied with different loads. Exterior walls may be single layered or multi-layered, bracing and/or non-load-bearing.

Element	Formation	Requirement
Wall	load-bearing and / or bracing	Load bearing capacity
		Fire safety
		Sound protection
		Heat protection
	non-load-bearing	Moisture protection
		Fire safety
		Sound protection
	single layered	Heat protection
		Moisture protection
multi-layered	load bearing throughout the whole section	
	separation between load bearing, insulation and protection layers including insulation	
Insulation layer	Exterior	
	Interior	
	Core	
Cladding	ventilated	
	not ventilated	

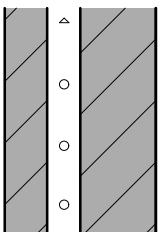
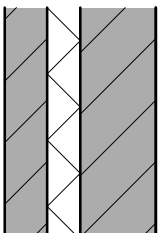
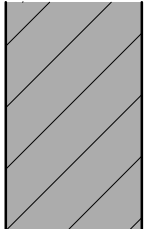

Multi-layered exterior walls normally consist of a inner load bearing structure and a protection layer on the outside. The core space may be ventilated or insulated.

Examples are visible masonry or light concrete sandwich elements.

In the modernisation of such structures, the functionality has to be examined and if necessary, some layers may have to be removed to ensure load-bearing capacity and airtightness.

Surface / cladding

Surface	Formation	Requirement / preparation
Single layered wall		
Plaster	Ground	Check dryness and strength, remove loose parts
	Bottom layer	
	Top layer	Evaluation of diffusion capacity and physical simulation if necessary

- 28. Single layered masonry
- 29. Insulated sandwich element
- 30. Ventilated structure

Insulation	Older composite systems, e.g. 6-8 cm Styrofoam, plastered	Evaluation of diffusion capacity and physical simulation if necessary Dismantling / Demolition
Cemented cladding (mineral)	Ceramic tiles	Check dryness and strength, remove loose parts or demolition of cladding
	Brick tiles	
	Concrete panels	Check airtightness of joints
	Stone	
Veneer	Brick veneer	Check dryness and strength, remove loose parts or demolition of cladding Check airtightness of joints
Multi-layered exterior wall - none load bearing exterior layer		
Masonry	Brick, concrete	Check statics of outer brick layer and tightness of insulation layer. Demolish outer brick layer if necessary.
Concrete, Light concrete	e.g. Ciporex	Check statics of outer layer and tightness of insulation layer.
		Demolish outer layer if necessary

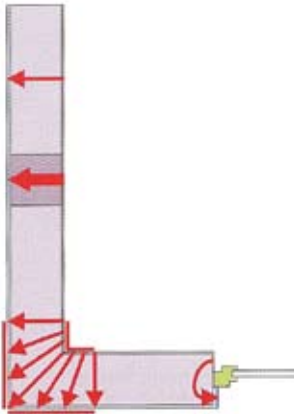

31. Principle heat transmission

It is essential, that the TES element is regarding insulation tightly connected to the existing envelope, particularly on uneven, rough surfaces or deep grooves, in order to avoid hollow spaces and tunnels which may cause uncontrollable convection or moisture.

Set-back line

In the case of buildings located on set-back lines, building regulations have to be checked for possible overlapping and an agreement has to be found with neighbours and local authorities.

Corner

Geometrically we distinguish inner and outer corners of a building structure. Both form, depending on the transmission resistance of the building materials, considerable geometrical heat bridges.

When mounting orthogonal TES elements to an existing building, the corner connection is a particular challenge due to a possible and large perpendicular deviation. Therefore deviation in x-, y- and z-axis has to be considered very carefully in survey, planning and production design stages.

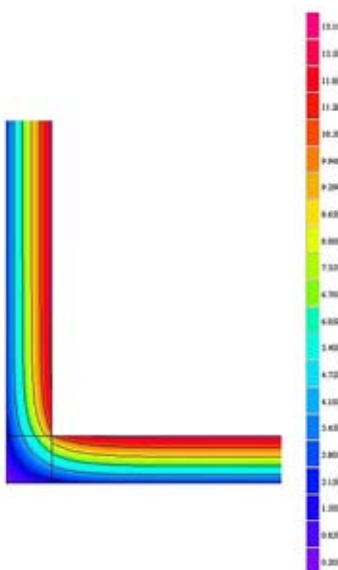

32. Isotherm curve of an uninsulated exterior corner. Temperature on the surface inside is below the critical Temperature of 12,6 °C.

Joints

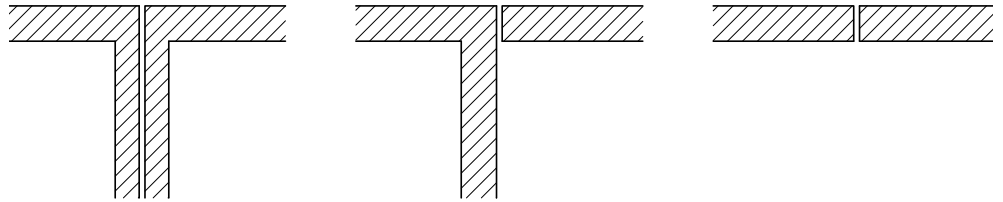

33. Façade joints in existing constructions.

Joints are planned gaps in a building structure which separate building sections, elements and / or materials. After modernisation the functionality of the gap has to be ensured. If necessary they will be adapted by the TES element and constructed according to requirements of building physics or fire safety.



34. Joint in concrete skeleton structure

Element	Formation	Mechanical stress
Joint	Connection joint	
	Expansion joint	
	Coupling joint	
	Mounting joint	
Construction	Open joint	
	Ventilated joint	
	Covered joint	
Deformation	Butt joint	Expansion force
	Overlapping joint	Shear force
Stress	Mechanical	Joint movement
		Wind pressure / suction
	Physical	Wind
		Temperature
		Moisture
		Rain
	Chemical	UV radiation
Interaction of materials		
Airborne pollutants		
		Detergents

Concept TES element

Intervention	Feature	Detail	
Element type	Protective shell	Timber frame element	
	Replacement	Timber frame element	
		CLT element	
		Structural façade	
Construction	Optimal transmission resistance	spec. stud (FJI, Upsi)	
		Crossed batten	
		Soft wood board (outer layer 6-8 cm)	
Fixation	Load optimised	Extra stud	
		Force locking	Cantilever
		Bracket	
Joint	Form locking	Posted on ground	
	Expansion joint	Horizontal / vertical	
Rain protection (e.g. DIN 4108-3)	Building envelope / Protective layer	None ventilated cladding	
		Ventilated cladding	
		Plaster	
Moisture protection (e.g. DIN 4108-3)	Joint TES element / existing envelope	Airtight construction to avoid convection	
		None ventilated cladding	Diffusion open, water-repellent layer
		Ventilated cladding	
Fire safety	Element (material)	Encasing	
	Horizontal separation	Sill	
	Vertical separation	Separation to avoid fire spreading from element to element	

Boundary line

— ideal boundary line
warm / cold

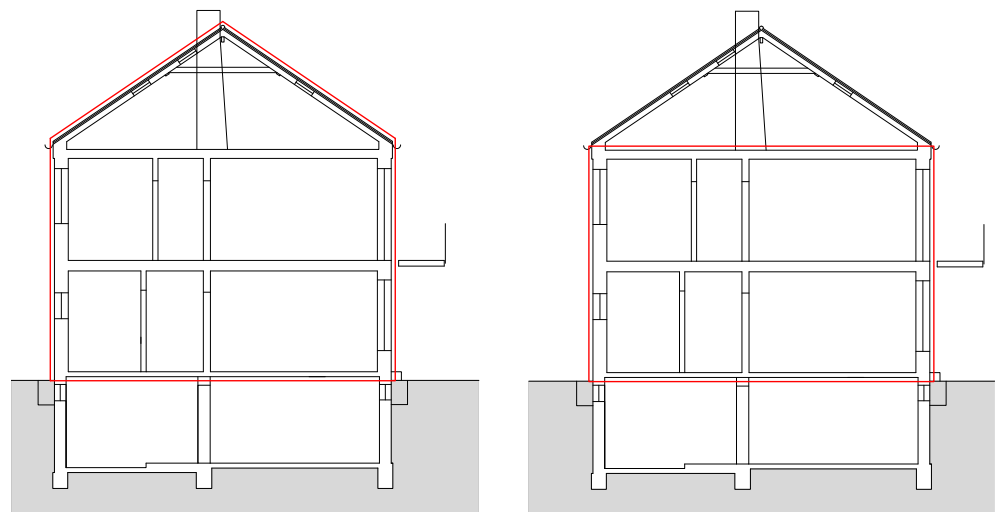

35. Heat bridge at roof eaves: no heat bridge or a negligible geometric one (left), on the right there is a constructional heat bridge remaining.

2.3.4. Window

Windows as part of the building envelope serve for light, ventilation, exterior relation and fresh air supply.

Window:

- Wood
- Aluminium
- Steel
- Plastic

U-Value (EnEV 2009):

U = 1,30 W/m²K (heated > 19°C)

Element	Form	Requirement	
Window	Function	Thermal protection	
		Sound protection	
		(Fire safety)	
		Rain and water tightness	
		Airtightness	
		Moisture protection	
		Burglary protection	
		Construction	Single frame
			Double frame
			Composite frame ('Verbundfenster')
			Box frame
		Mechanical feature	Fixed glazing
Casement window			
Tilt-and-turn			
Hopper			
Awning			
Turning frame			
Single-hung (vertical)			
Lifting sliding frame			
Sash window			
Situation	Inner stop		
	Outer stop		
	Flat		
Glazing	Single glazing		
	Double glazing		
	Insulated double glazing		
	Insulated triple glazing		

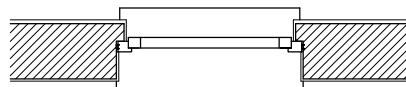

36. Inner stop against outer reveal projection



39. Situation interior against façade columns

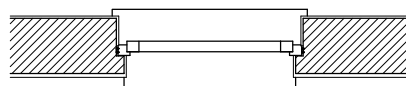

37. Outer stop against inner reveal projection

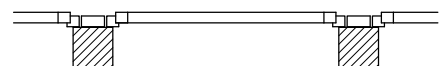

40. Situation in front of façade columns

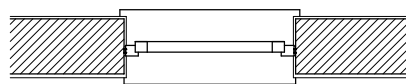

38. Flat connection to reveal

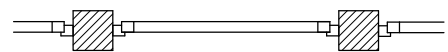

41. Flat connection between columns

Situation

The following details represent schematic as-built situations of windows as part of the building envelope revealing energetic weak points in old building.

Inner stop:

Rebate at reveal and top, flat at sill

Roller shutter box

Niche for radiator

Weak points:

- Considerable reduction of wall thickness.
- High transmission loss
- Convection and missing wind-tightness of shutter-box

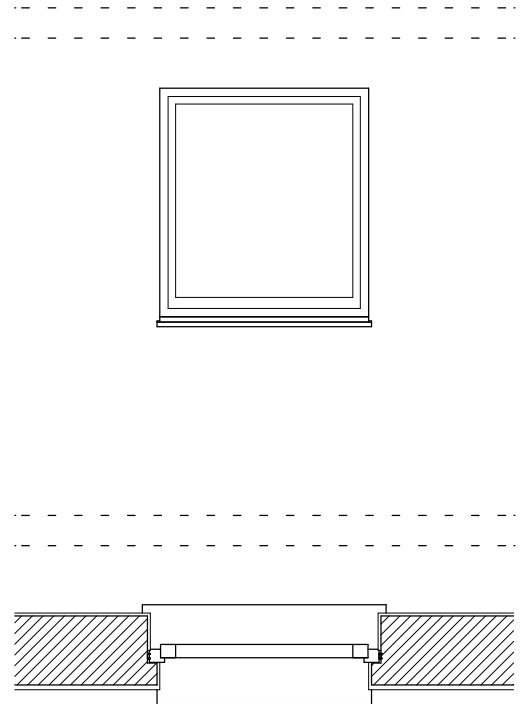
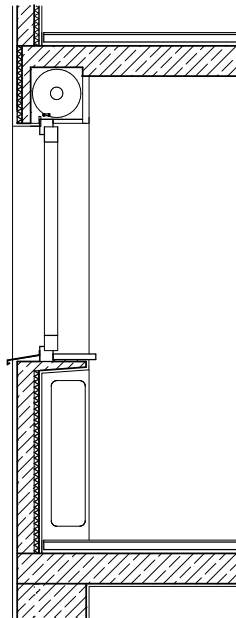

Flat:

Window frame flat against reveal

Brick beam

Weak points:

- Heat bridges
- Connections frame and wall are not protected

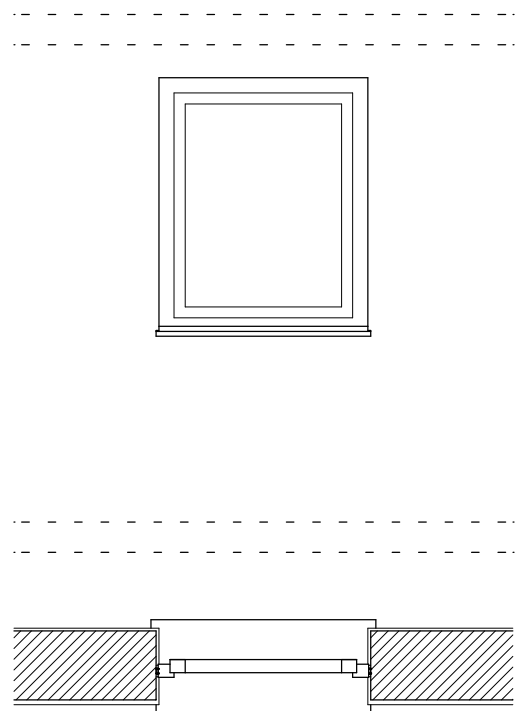
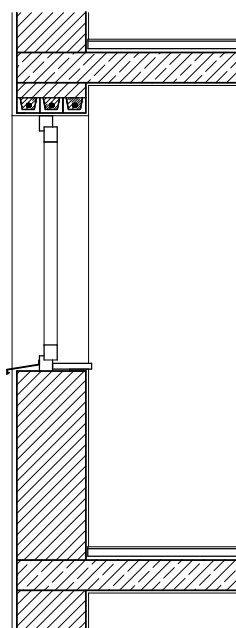

Spandrel panel ribbon glazing Bandfassade

Load bearing or non-load-bearing parapet

Flat window frame connection

Weak point:

Depending on construction high transmission loss

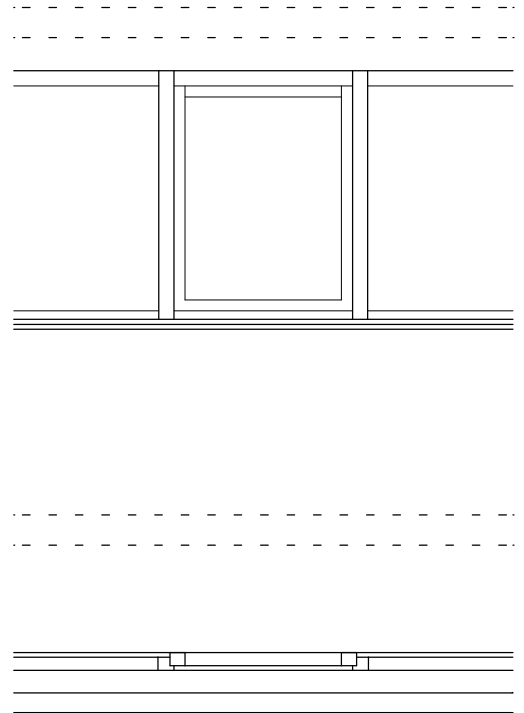
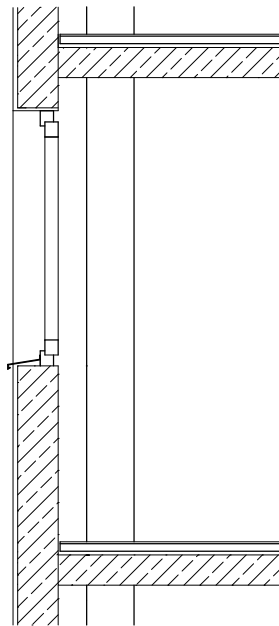

Curtain wall

Non-load-bearing structural glazing façade

Weak point:

Depending on construction high transmission loss

Sound transmission

Reduced fire safety (edge floor slab)

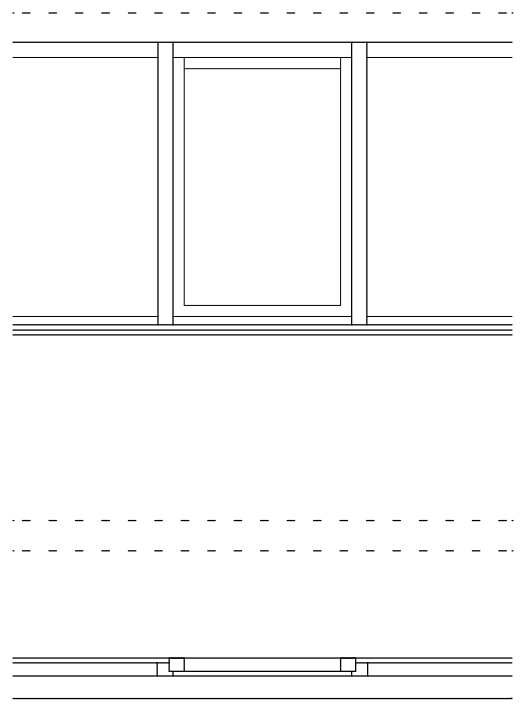
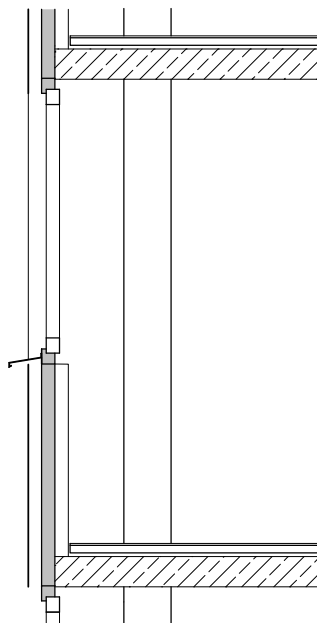



42. Interior rolling shutter box and radiator niche, brick masonry 30 cm, D-Augsburg



43. Exterior shutter box, D-Augsburg



44. Double layered brick masonry with timber framed window element, 10 cm, poor insulation standard, NL-Roosendaal



45. Curtain wall at stair case, loggia with additional glazing for noise protection, D-Augsburg



46. Spandrel panel ribbon glazing

47. Window, aluminium flat against reveal and parapet.

48. Window sill, cable channel and radiator in front off parapet.
D-München, Umweltamt



49. Exterior structural glazing façade with rotating tilting frames, sun shading device, D-Buchloe, Realschule





50. Timber frame wall with poor insulation, large window areas, NOR- Rsiør, College

Concept TES element

Intervention	Feature	Detail
Preserve window	Reduction of heat bridges	Insulation to cover frame
Partial replacement	Additional window frame	Box window - „Kastenfenster“
Replacement	New window	Integrated into TES Element
Fixation	To existing structure TES integrated	
Joint	Sealing Encapsulating	
Reveal	Interior wall Case	Adjustment, e.g. plaster Reveal case as part of TES element

2.3.5. Ceiling and Balcony

Ceilings are horizontal, space forming building elements, which are classified as slab (e.g. reinforced concrete) or beam structures. Looking at the different temperature zones of a building, one has to differentiate between basement ceilings, regular storey ceilings and the top ceiling which may be the border to an unheated attic.

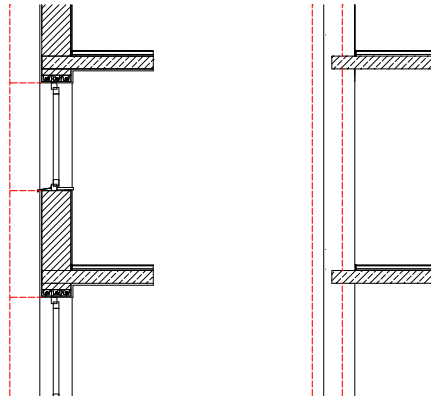

51. Two types of exterior wall construction.

Embedded ceiling edge

e.g. brick construction

Linear support

Brick in front of ceiling edge

- Fixation of horizontal loads

Free ceiling edge

e.g. skeleton structure

Punctilio support

- Anchoring of horizontal loads
- Support for vertical loads

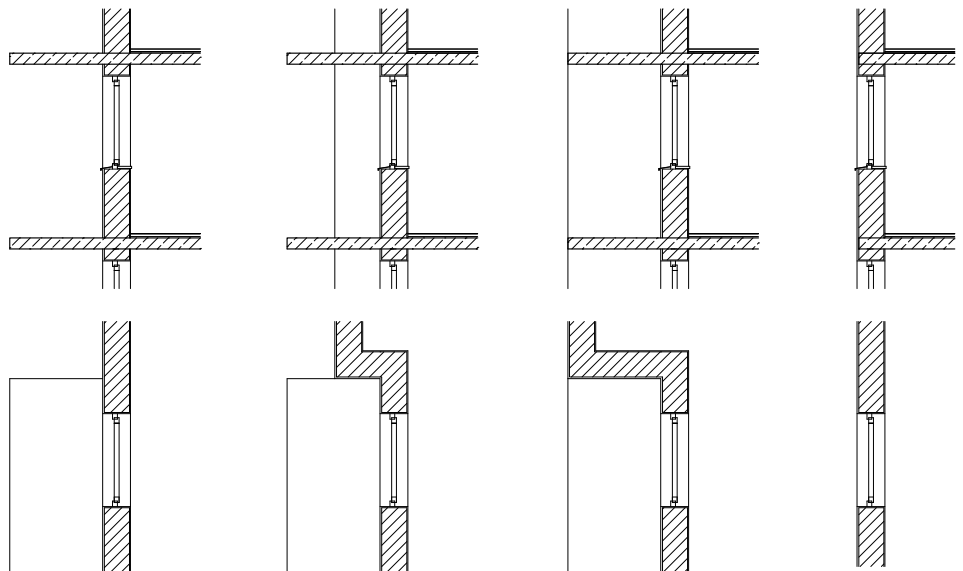

52. Ceiling and balcony constructions.

1. Cantilevered ceiling, e.g. balcony
2. Partly cantilevered ceiling
3. Ceiling embedded, e.g. loggia
4. Ceiling edge equal with exterior wall



53. Cantilevering slab



54. Loggia



55. Partly cantilevered slab



56. Balcony

Ceiling in brick structures

Depending on the construction of a brick wall, the edge of the ceiling is:

- a) flush on the outside
- b) set back with an insulation strip
- c) set back and covered with a brick layer

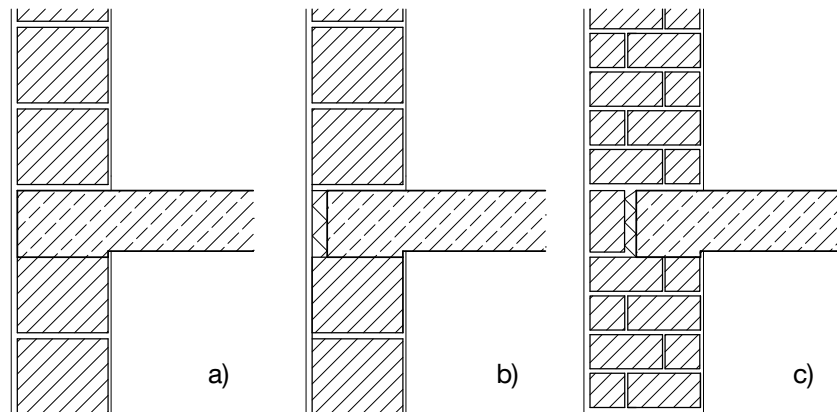

In case of fixation of TES elements to the ceiling edge, e.g. brackets, supporting beam etc, the compression strength of the wall has to be evaluated.

The ceiling edge contains additional reinforcement (ring anchor), which may also make up the supportive structure of window heads.¹¹

Concept TES element

Intervention	Feature	Detail
Heat insulation	Cantilevering ceiling	Cut off
	Partly cantilevering c.	Cut off or case in
	Embedded ceiling	
Load bearing	Horizontal securing	Fixation in ring anchor
		Fixation in slab
	Vertical load bearing	Placement on ceiling edge and / or on beams of the existing structure
		Bracket fixed to load bearing structure



57. Cutting off balcony slab

11 Schmitt (1988) Hochbaukonstruktion, Vieweg, Braunschweig.



3. Method

3. TES Method

The TES method advances the energetic modernisation of the building envelope using prefabricated large-sized timber frame elements. The economical, ecological and social advantages of the system suggest a very sustainable renovation method. Necessary responsibilities of all stakeholders are set within a digital workflow as state of the art in survey, planning and production. The process provides a consistent structure along the workflow chain:

building examination - digital measurement – planning – off-site fabrication – on-site assembly

The general idea of the TES method is a frictionless workflow based on a regular planning process starting with a thorough building examination at the beginning. Prefabrication or off-site fabrication is preconditioned to a completely planned building structure and construction. Once the production process has started, changes are costly and will cause delay in the further workflow chain.

Interdependent decisions (e.g. architecture, material and appearance, structural engineering, fire safety and building physics etc.) have to be made with regard to the state of the existing building at the planning stage of a modernisation project.

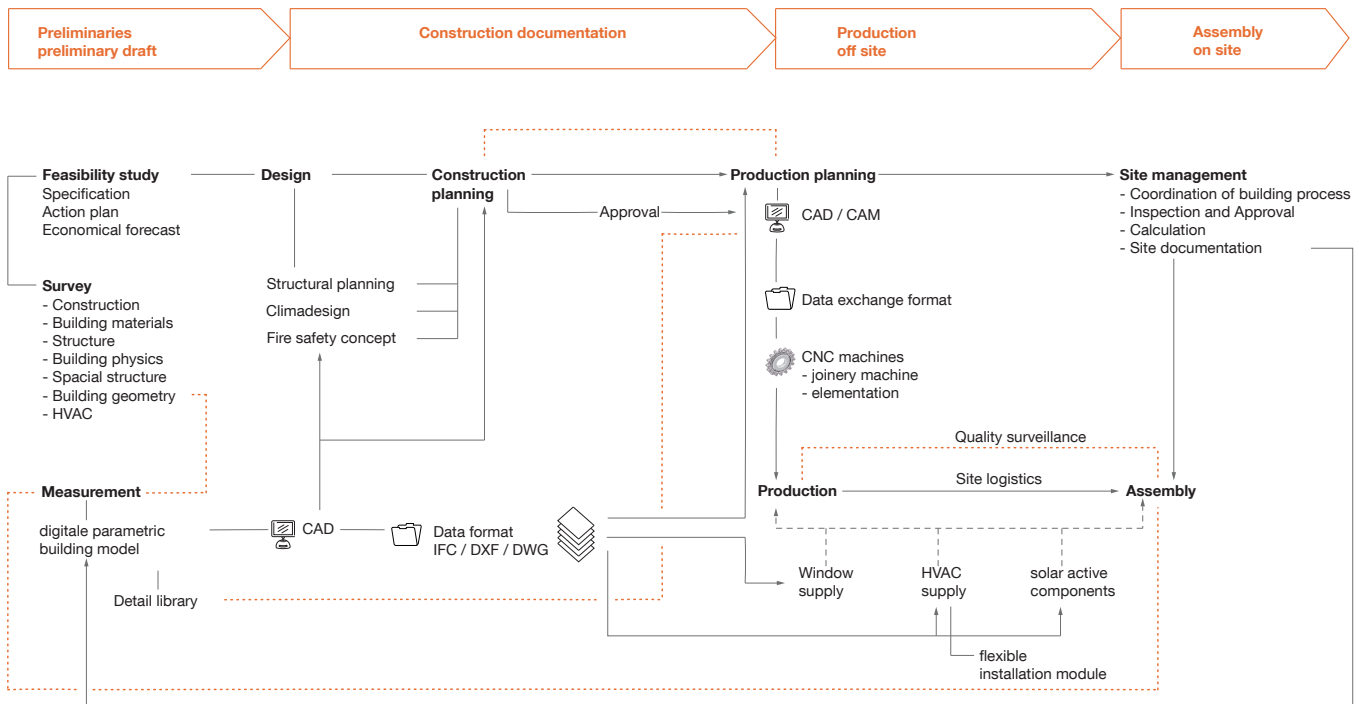

58. TES process diagram.

Building examination and construction documentation

The task of the primary investigation is to examine and document the state of the building with regard to the later intervention of improving the technical and energetic performance as well as the architectural appearance.

The following points need special attention¹ and should be documented in the investigation report:

- Analysis of the general structure of the construction (adaptability / changes)
- Defect detection in structure and construction (e.g. concrete corrosion)
- Load bearing capacity and definition of points / zones for fixation
- Existing Joints
- Properties of existing materials (U-value, density, strength, stiffness, etc.)
- Existing heat bridges
- Building layers or elements to be removed
- Hazardous materials (e.g. PCB, asbestos)
- Fire safety conditions (construction, emergency escape routes)
- Accessibility of the construction site and its close neighbourhood
- Accurate measurement of geometry

Experiences gathered in the monitored projects shows, that deficiencies of the construction might well be hidden and only come to light during the building process, causing delay and financial uncertainties.

A proper and cost efficient, durable and aesthetic, in other words sustainable, solution considers and balances all facts and preliminaries. Opportunities and risks of the future construction work can be evaluated at the planning stage when they are based on a comprehensive knowledge of the existing object.

Opportunities	Risks
Profound knowledge base	Hidden damages
Optimisation of detail planning	Insufficient fire safety measures
Sustainable investment	Delay of construction work
Planned to LCA	Hidden hazardous material
Cost-benefit analysis	Cost overrun
Integration of multiple functions in a multilayered building envelope	

¹ Recommendation based on the experience of several monitored retrofit projects

Tailor made vs. digital customisation

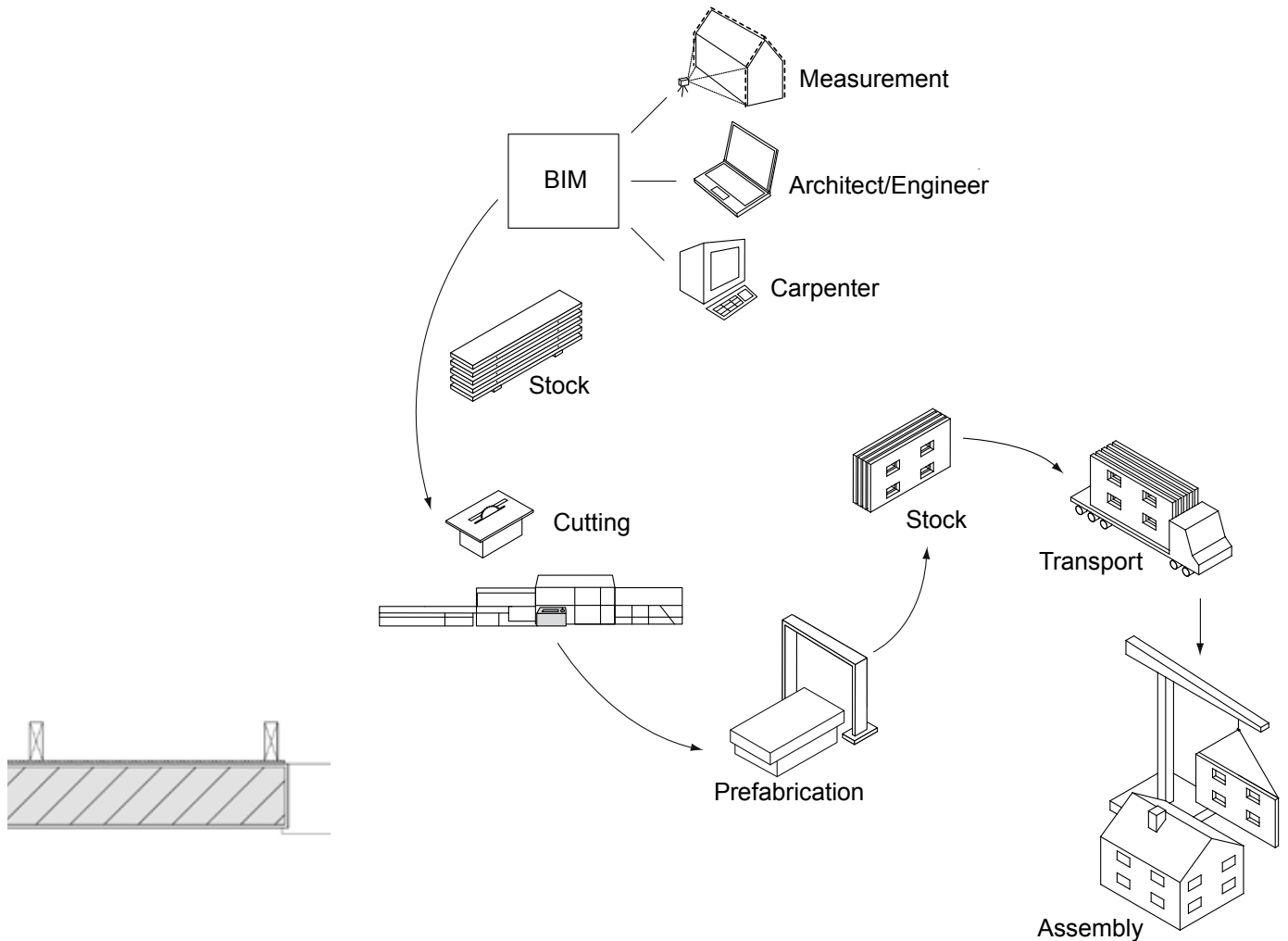

59. Prefabrication and installation process.

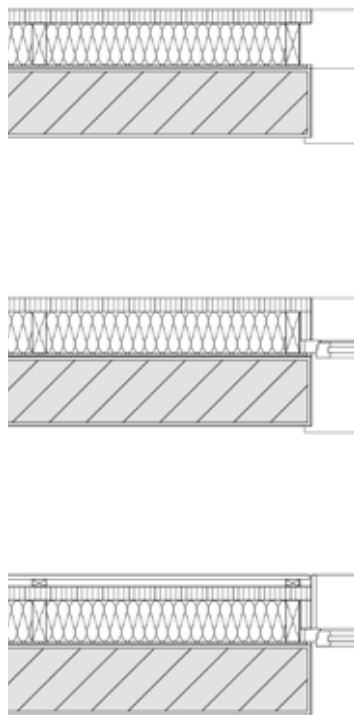

60. Prefabrication degrees

Production technologies (e.g. CNC machines) and a frictionless workflow from survey, planning to production based on digital data enable the more or less complete manufacture of building elements (e.g. wall panels) off-site in a factory. This method is state of the art for the construction of new buildings² and opens new possibilities for retrofit projects, as with customisation it is possible to achieve individual, economic competitive solutions. Modern manufacturing methods are characterised by optimised production processes with the use of more or less automated cutting and joining machinery. Standardised procedures in a sheltered factory environment enables a controllable high quality result.

The level of prefabrication is determined by the contractor's facilities as well as the geometry of the wall panel and the situation on-site. The varying degrees of prefabrication are characterised by the completeness of a building element, from single cut parts (e.g. post, plate), unfilled wall frames to completely finished insulated wall panels including cladding and even windows and glazing.

The benefits of a high prefabrication level are:

- Enhanced speed, quality, and durability of construction
- Simplified on site processes
- Improved thermal and moisture management performance
- Customised production within the factory setting
- Predictability of cost and schedule

The co-ordination of decision making and working procedures plays a major role within the off-site manufacturing process, preconditioned by comprehensive communication between clients, designers and contractors concerning all process relevant contents.

Josef Kolb explains in his book “Holzbau mit System”³ the interrelation of the single steps in the production process of a project, planned and built in timber. Scheduling the project, a time slot has to be included between planning and production for work preparation and ordering of sub products such as windows and cladding material.

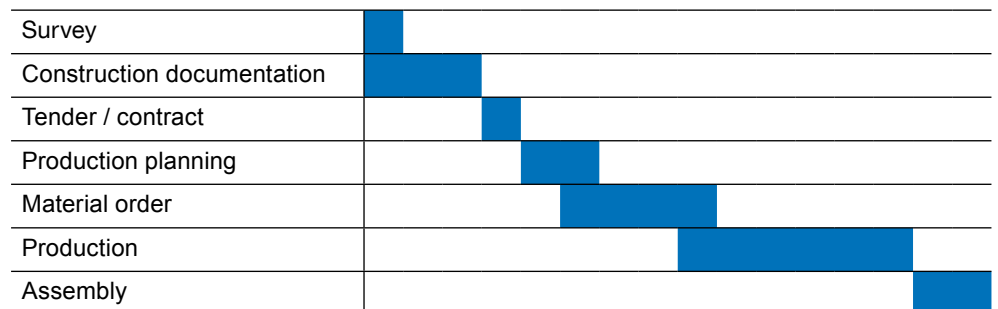

3. Interrelation of project steps

The potential of parametric design and digital production provides a radical new possibility for customisation and off-site fabrication for the application of TES EnergyFaçade elements. A complete set of construction drawings has to be finalised before the manufacturing process can start. Based on a coherent Building Information Model BIM the digital production planning of the customised building envelope is the heart of the planning and production process.

Depending on the complexity of the project task the integration of a planning team with specialists is recommended to entirely cover the issues of architecture, engineering and production planning at an early project stage.

Summing up, off-site fabrication in a controlled environment of a factory workshop combined with the technical possibilities of customised digital production has an enormous benefit on the quality standard and outcome of retrofit projects. The competence of the timber construction sector needs to be challenged according to the project preconditions (i.e. size, geometry, construction standards etc.).

3.1. Survey and Digital Workflow

Survey and digital workflow are the backbone of the prefabrication process in renovation. In this chapter the requirements and methodologies of surveying are discussed. The questions of digital workflow, (which concerns the use of digital data acquired during the survey work in the subsequent phases of the TES process) and in the management of the facility after the intervention are vital components in this prefabricated envelope solution.

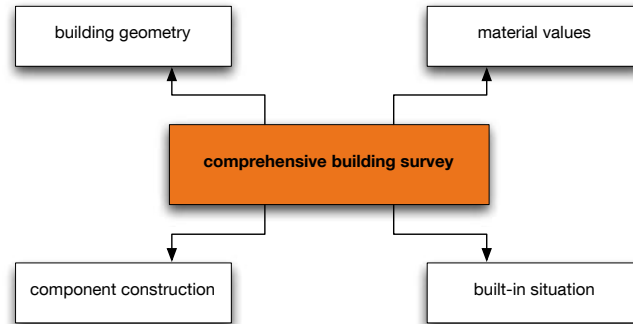

61. Comprehensive inspection of a property.

The purpose of the survey

Due to the lack of adequate documentation of the as-built/as-maintained condition of existing buildings, renovation and refurbishment work today often suffer from estimation errors, inaccurate bids, design and fabrication mistakes, expensive field rework, etc. It is estimated that between 2% to 5% savings on the total project cost can be achieved with the better capture of existing conditions.⁴ The second vital issue is that TES is a prefabricated renovation method and needs CAD/CAM models for production. Combining the conditions of an existing object with new adapted and industrially manufactured parts lead to the model known as reverse engineering (RE). The process of RE is described by Abella et al. as “*the basic concept of producing a part based on an original or physical model without the use of an engineering drawing*”.⁵

Thus, a complete building survey is the first crucial step in the TES process.

A building survey is a comprehensive inspection of a property. In the TES process there are two aspects of the survey:

1. To establish a digital three-dimensional (3D) model of the building and the façades on which the prefabricated elements shall be mounted so that the elements can be fixed to the existing structure without the need to adjust the elements on-site and to define the exact sizes / shape of the prefabricated element.

⁴ Spar Point Research LLC (2006) *Capturing Existing Conditions with Terrestrial Laser Scanning*. Document downloaded from <http://www.sparllc.com>. verified 24.08.09.

⁵ Abella R. J., Daschbach J. M., McNichols R. J. (1994) Reverse engineering applications. *Computers and Industrial Engineering*, 26(2), pp. 381–385.

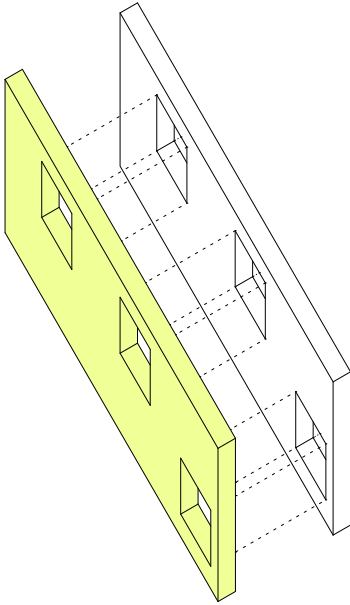

62. The prefabricated TES element has to fit on the existing façade like a stencil.

2. To document particular characteristics of the building façade that may influence the mounting of the elements (e.g. cantilevered concrete beams) or impair the subsequent improvement of the efficiency in the building's energy consumption. Possible damages to the existing façade should be noted. This type of survey is an analytical description, and may include notes, sketches, and photos.

The non-geometric information is as vital as the 3D model. However, this information in the form of e.g. written documents and photos are separate documents, which are difficult to provide to project members in a consistent and discreet manner. Nevertheless, technologies like project webs and Electronic Document Managing Systems (EDMS) offer possibilities for integrating all relevant data.⁶ Software tools such as Navisworks® can manage the three dimensional object data (e.g. from survey, design etc.) combined with images and building information as well as the analysis of integrity and visualisation.⁷ The benefit of such tools is a joint database for all project members and the avoidance of collisions and mistakes due to inconsistent data. However, a recent study shows another possible approach for capturing all necessary information from a building survey in a uniform Building Information Model (BIM) as basis for all further activities in a project.⁸ The authors of this study suggest a method for the mapping of surveying data in the IFC format, including surveys, building geometry, descriptions of the condition for single building components as well as component assemblies, and building component defects in their position and size. This could be technically solved by a structured mapping functionality based on existing IFC classes in combination with a content management system (CMS).

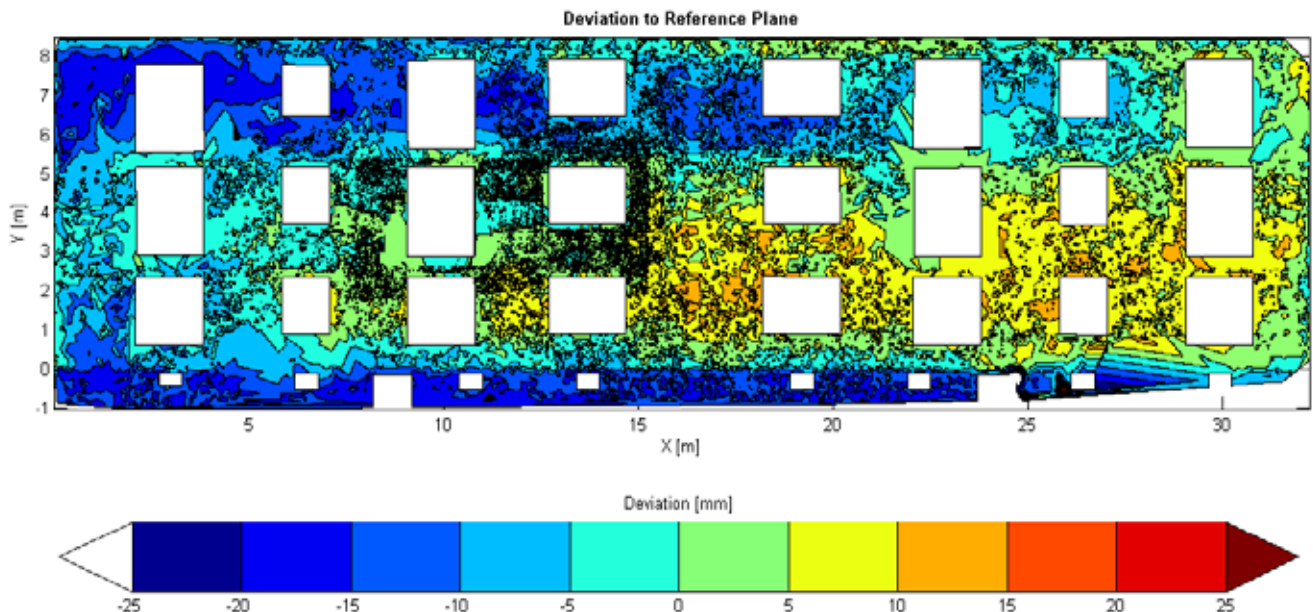

63. Irregularities of a façade with a size of around 32 x 9 m. The maximum deviation perpendicular to the surface plane is in total between 30 and 40 mm.

6 Rajala, M. & Penttilä, H. (2006) Testing 3D Building Modelling Framework in Building Renovation. In: 24th eCAADe Proceedings, Volos (Greece), pp. 268-275.

7 Personal information from Mr. S. Schrenk (28.09.2009) of BuildingTools GmbH, Munich, a software reseller and CAAD/BIM service provider.

8 Götting, R. & Braunes, J. (2009) Building Survey in Combination with Building Information Modelling for the Architectural Planning Process. In: 27th eCAADe Proceedings, Istanbul, pp. 69-74.



64. Example Rötlinstrasse, Frankfurt, Germany. A typical post-war building from the early 1950s.

Survey of irregularities in the building façade

Existing buildings will only in exceptional cases be regular and precise in all directions. Planning the TES system, such irregularities must be carefully observed and documented in the 3D model as well as descriptively. Examples of such irregularities are sloping walls (out of plumb) and unevenness of the façade. The regular TES EnergyFaçade element will be rectangular and rigid and will not be able to accommodate per se any unevenness in the underlying, original surface where it is to be fixed. Therefore some kind of gap between the element and the existing wall must be considered. The dimensions of this layer must be carefully evaluated considering structural issues, building physics, issues related to the mounting of the elements, not to mention economic issues. Thus, the documentation of the topography of the façade is essential for the successful application of the TES system. Gathering of data, computing and visualisation will be described for the different geometrical building survey methods.

Survey of the building's environment

In renovation and refurbishment work we encounter some of the same restrictions as in new construction, for example the necessity to consider the surrounding environment, including neighbouring buildings and vegetation, lot borders, etc. Even greater restrictions are imposed on the planner when dealing with existing buildings due to the fact that structural conditions, architectural detailing, and technical installations are fixed conditions that one must understand the significance of and relate to.

The existing building must be considered in its environmental context and not as an isolated object. Here are two examples that will illustrate the need for a holistic approach:

1. To perform an analysis of the natural lighting conditions inside a building that will be refurbished in a TES process, one needs the information of surrounding buildings as well as large trees, etc.
2. The transport of the elements to the building site and the possibility of driving a truck right up to the building is dependent on possible hindrances in the surrounding environment, which have to be documented. Modern surveying methods, especially 3D laser scanning, also allow a quick and complete documentation of surroundings. The level of detail of the information for this overview can be reduced compared to the level of detail required for the building itself.

Preamble to survey methodology and contents

The existing substance cannot be surveyed as a collection of independent parts. The energy efficient retrofit has to consider a building as a whole. Therefore surveying solutions embracing the object as a whole have to be established while considering the economic aims of the modernisation.

The measuring methods of the survey will depend on:

1. The construction of the existing building (load bearing and non-load-bearing external walls).
2. The construction process delivery system.

3.1.1. Economic Survey

Below are results of a field test of the appropriate measuring methods for façade surveying. The spider diagram is a result of the analysis of a survey campaign for a building in Rotlinstrasse, Frankfurt. Prof. T. A. Wunderlich, the chair of geodesy, and his staff supported the survey and provided a technical report which was compiled by S. Rauch⁹.

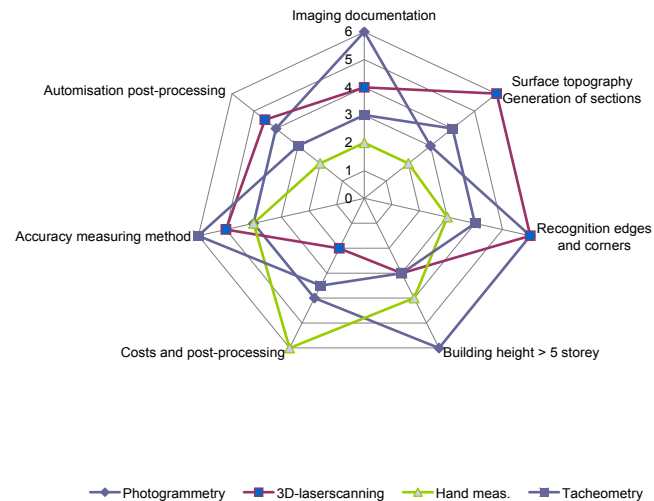

65. Influencing parameters on several measuring methods used in façade survey (close to centre is not recommended). Hand measuring is mentioned for comparison, but it is not competitive as it lacks 3D properties.

The graph recommends appropriate surveying solutions depending on the building's attributes. It is important to consider all attributes of the object and aspects of surveying in an individual project to avoid unpredictable results.

Two alternatives for economic survey contracting can be deduced.

First solution: As soon as feasibility studies recommend a TES EnergyFaçade, undertake an entire survey and a 3D model or 3D image. This implies that the planner is able to handle the data and has reverse engineering experience.¹⁰ Alternatively a surveyor can also provide geometric models with correct data structures. If higher level product models, in other words BIM models, are needed the support of experts in building construction is necessary. BIM models demand a high level of construction specific know-how which is only available to architects and engineers in order to provide comprehensive survey information for the further design process.

The second solution will be more practical in today's construction industry. In a first step only a holistic hence not geometrically detailed investigation is done. This is the basis for design planning and tendering. A second step follows when the project is contracted. In this phase a detailed survey is subcontracted or undertaken by the general contractor.

Experience in several projects shows that intensive communication, at the very beginning, in the survey planning phase as well as in the post processing phase

⁹ Rauch S. (2008) TES EnergyFaçade, Fassadendokumentation der Rotlintstraße 116-120, Frankfurt am Main, Technical Report from Department of Geodesy, Prof. T. Wunderlich, TU München.

¹⁰ Specific software is e.g.: kubit PointCloud ® an AutoCAD Plug-in; Rhinoceros 3D ® by McNeel; Cyclone ® by Leica; and a few more.

between the end user of the 3D model and the surveyor is essential for efficient and proper survey results.

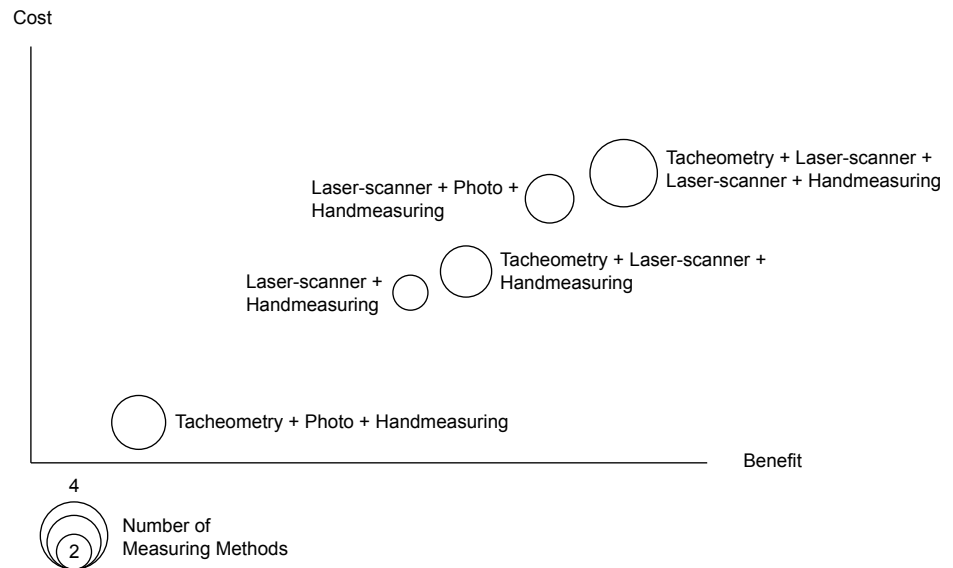

66. Benefit-cost ratio of the used measuring methods. Source Rauch 2008.

3.1.2. Methods of Geometrical Building Survey

The existing information about a building goes back to its approval phase, in some cases also to its construction phase. The documentation of the actual built situation (“as-built”) as well as alterations made during the lifecycle of a building (“as maintained”) are seldom or only partly available. Only in rare cases will existing drawings of buildings represent the as-built / as-maintained condition. However, it may be cost-saving in the initial phase of the TES process to check the reliability of existing drawings. This may be done by simple hand measuring devices on site. In the case of satisfactory accuracy of existing documentation, paper drawings may be digitised and used to build a 3D model of the facility. Another proposal is the use of photogrammetry to survey the actual state. There are a few CAAD tools already integrating the capability of single image orientation and orthophoto generation.¹¹ Software for the more sophisticated 3D photogrammetry is also available at moderate costs. The learning curve of such tools isn’t very high and the result is an entire documentation that is available for basic area tracing as well as measuring of details in 2D.

Since exact documentation of the existing state may be wholly or partially be missing and the reliability of the existing sources may be doubtful, most TES processes will require a complete and detailed survey of the existing state. This is described as the first phase of RE by Raja et al. (2008), with the slight difference that he focuses only on scanning methods.¹² All modern measuring methods create polar coordinates from the measured object therefore you can simplify data acquisition in a scanning process. In principle RE starts with the acquisition of polar coordinate geometry from an object. The second and third phase of RE are described as the point processing and the application geometric model development. In point

11 CAAD tools with PG capabilities e.g.: Nemetschek Allplan ® and Vectorworks ®; kubit PhoToPlan ®; MuM cadExpert® Image Tools both an AutoCAD Plug-ins and a few more.

12 Raja V., Fernandes K. J. (2008) Reverse Engineering – An Industrial Perspective. Springer. London, 2008.

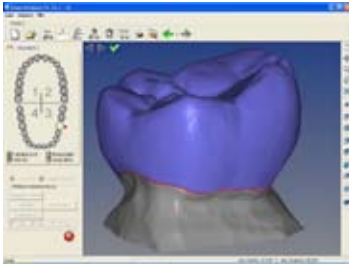

67. Typical application of a reverse engineering process with uneven surfaces in dental technology.

processing, combination of data of different states or points of view during measuring and the cleaning of inferences or superimpositions takes place. Finally the application geometric model development is the most complicated and time consuming act. There are routines for semi-automated data analysis, manipulation and modelling but it is limited to a certain degree. In TES EnergyFaçade for example CAPLAN, a surveyor software tool, was used for semi-automated digital surface modelling as described in 3.1.6.¹³ Raja et al. (2008) pointed out that the derivation of surface models from raw data is a subjective process. As a consequence, the preservation of data accuracy and reduction of cost intensive remodelling demands other strategies. A result of this is the development of the new façade elements inside the geometric point cloud model after point processing. An exact remodelling of reality is obsolete because the new parts are constructed inside point clouds instead of models, derived from point clouds.

In addition to hand measurements by measuring tape, hand-held laser distance meters, etc., there are three approaches in 3D measuring technology that are applicable to building survey. The first is based on traditional methods in geodetic land survey, the second is based on photographs, and the third is based on laser light:

Photogrammetry

Photogrammetry (PG) can be defined as „the art, science and technique of determining geometric and other properties of objects by measurements and observations on photographs of those objects“. The techniques of photogrammetry date back to the mid 19th century. For more than a century it has been used mostly for mapmaking and surveying, based on aerial photography. The use of close-range (terrestrial) photogrammetry has increased over the the last decades, a progress made possible by the development in technology, especially in the information technology. The introduction of digital cameras in the 1990s dramatically changed the possibilities of photogrammetry. Digital cameras and dedicated software for the analysis of photos to create 3D images has introduced the era of digital photogrammetry.



68. Multi-image 3D photogrammetry - postprocessing / 3D modeling of discreet façade points.

13 CAAD tools sometimes support digital surface modelling: e.g. Nemetschek Vectorworks®.

When photogrammetry is applied to 3D building survey, the building is photographed in such a way that each and every detail (part of the surface) is imaged in at least two photos. 3D co-ordinates of points on the building are computed based on co-ordinates of their imaged points, measured in two or more photos. For some purposes where the object is close to planar, and where a high accuracy is not required, results can also be obtained from single photo measurements. Large and complex objects are recorded on a number of images that are stitched together.

In fact photogrammetry is a very robust method, because it is insensitive to rough conditions like shocks or vibrations. The amount of data generated guarantees a high level of detail and data integrity is ensured. There is a lack of analysis possibilities for the façade topography due to a small deviation in the depth of façades in the range of 1 – 5 cm, as is usual for most façades. This method is also more difficult to use when combining inside views and outside elevations of a building.

Tacheometry (“Terrestrial Point Scan”, TPS)



69. A modern Tacheometer also called Totalstation.

Tacheometry is a system of rapid surveying, by which the positions of single points on object surfaces are determined from horizontal and vertical angles together with the distance. The original tacheometer was a theodolite where the distance was obtained from readings on a levelling rod. The instrument used today is a „totalstation“, where the angles are read electronically, the reflector-less, automatic distance measuring is based on laser light, and the co-ordinates can be computed instantly. The co-ordinates of the surveyed points are then downloaded to a computer, and application software computes the results to create a 3D CAD model.

In consequence all the discreet points on a façade are measured very efficiently. Discreet points are unique, single points that can be described precisely by a definite coordinate. It requires more effort to acquire enough co-ordinates in areas on the façade surface for unevenness analysis. This method is very suitable to combine records on the inside of the building with the façade survey.

Laser scanning (“Terrestrial Laser Scanning”, TLS)



70. Full featured 360° 3D Laser-scanner on a tripod.

3D laser-scanning describes the three-dimensional measurement of the surface of an object through the analysis of the reflected light from a laser beam which is scanned over the object surface.¹⁴

There are different measurement principles for laser scanners. Laser scanners relevant for buildings use the „time-of-flight“ principle (TOF). The distance is measured by measuring the time from emitting to detecting the return of a laser pulse. Mirrors or a rotating head are used to control horizontal and vertical angles of the laser light. TLS can collect large numbers of points, called “point clouds” in a short time, from a few thousands to several hundreds of thousand points per second. The problem with TLS lies in the post-processing of the point cloud. The analysis of point cloud data and converting them into useful information, e.g. in a 3D CAD model, is a major challenge. Possible solutions by wireframe extraction or point-cloud modeling are described in 3.1.5 and the case study of Rotlintstr., Frankfurt, Germany.

The relation between actual scan time and time for post-processing varies from 1:1

¹⁴ Luhmann, T. (2002) Photogrammetrie und Laserscanning Anwendungen für As-Built-Dokumentation und Facility Management. Wichmann Verlag, Heidelberg.

to 1:50, depending on the detail of the desired output.¹⁵ There are also values of experience from pilot projects, done in TES EnergyFaçade research project, showing that the post-processing of façades can be achieved with ratios between 1:8 and 1:10 depending on the regularity of the object.¹⁶ In the case of an ordinary modern three-storey building 30 x 60 m, in plan, the probable scan time would be 10 hours estimated by a surveyor.¹⁷ The development of a basic 3D geometric model without moldings and other architectural features would take 10 to 20 hours, depending on the number of windows.¹⁸ To date no automatic method exists for the creation of a 3D CAD model from a point cloud. Post-processing of 3D imaging data and the generation of 2D drawings and 3D models from this data are time intensive tasks and require specific experience. This technology allows the documentation of scanned areas together with pictures, taken with integrated cameras, and provides better spatial impressions and realistic textures. Each scanner company has its own proprietary software solution for data gathering and post-processing.

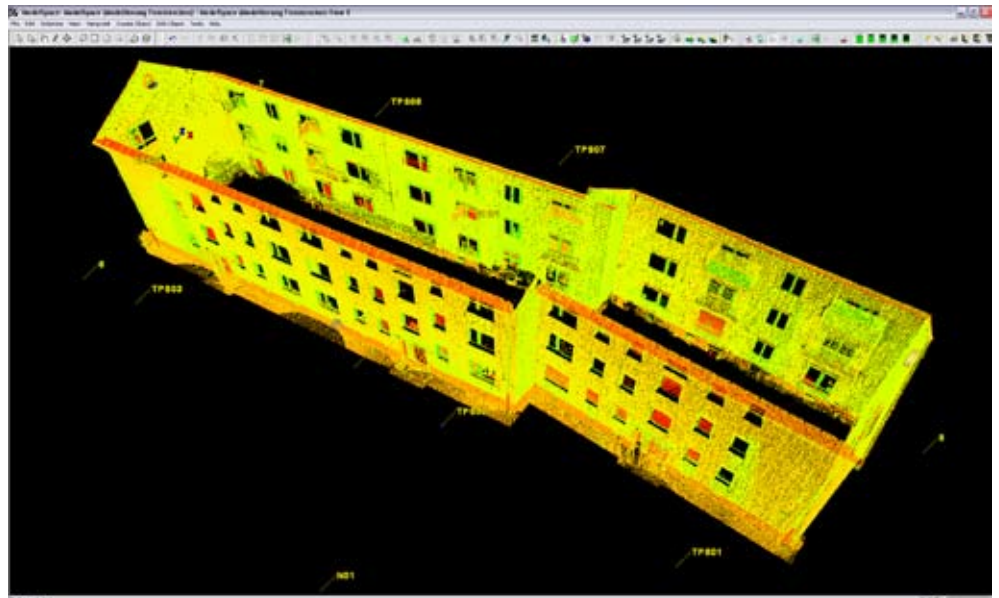

71. Entire raw data model consisting of a registered and cleaned point cloud, taken by a 3D laser-scan.

In addition to façade survey this method has a high capability of speed and level of detail, interior integration and the analysis of surfaces. Today's major issues are the cost for the application and the time factor for postprocessing / 3D modeling.

¹⁵ These relationship of 1:1 to 1:50 between scan time and post-processing was suggested by laser scanning experts during a workshop that was organised at the NTNU in Trondheim in September 2008 as a part of the TES EnergyFaçade project: "3D Laser-Scanning and Photogrammetry for BIM".

¹⁶ Personal information from Mr. R. Martinek (20.03.09) of the german surveying company GEOSYS (<http://www.geosys-eber.de>), this was also confirmed by Mr. T. Schäfer from the Department of Geodesy, TU München.

¹⁷ Image from the monitoring of the retrofitting project Rotlintstraße, Frankfurt, ABG Frankfurt Holding, architecture: Faktor 10, Darmstadt, engineering: bauart GmbH, Lauterbach.

¹⁸ Personal information from Mr. R.P. van Kersbergen (17.06.09) of the US surveying company Pharos (<http://www.pharos-us.com>)

3D geometric survey: Some general considerations

The key performance criteria that need to be considered with respect to the application requirements and constraints are according to El-Hakim and Beraldin (2007, 261)¹⁹ :

- Geometric fidelity of the final model (the accuracy or uncertainty)
- Generated level of detail (spatial resolution)
- Model completeness (percentage of object or site captured)
- Impact of the environment (surface type, accessibility, robustness etc.)

For the TES process there are a few other aspects of relevance:

- Integration of interior (preparation of the window sill and reveals)
- Topography analysis method

In most TES projects it is likely that a combination of the three above-mentioned methods will be necessary in order to develop accurate, cost-effective, timely, and comprehensive as-built/as-maintained information in the form of a 3D model. Modern methods or surveying techniques can be learnt by construction professionals as well, with a certain learning curve. However, as a general rule the services of professionals within the field of 3D surveying will be required for the use of any of these 3D measuring technologies.

	Photogrammetry	Tacheometry	Laser-scanning
Geometric fidelity	+	++	++
Level of detail	++	0	+
Model completeness	+	0	++
Interference	+	0*	0*
Interior integration	0	++	++
Analysis	0	+	++

* devaluation because of sensitivity due to vibrations and problems with invisible, shaded points.

4. Table: Eligibility of modern survey methods.

19 El-Hakim, S.F. & Beraldin, J-A. (2007) Sensor Integration and Visualization. In: Fryer, J., Mitchell, H. & Chandler, J. (eds) Applications of 3D Measurement from Images: Dunbeath: Whittles Publishing.

	(Hand-measuring)	Photogrammetry 2D/3D	Tacheometry	Laser-scanning
target points	discreet point	2D: every point 3D: only discreet	discreet point	non-discreet
measuring possibilities	limited to distances	2D: distances and angles in plane 3D: distances and angles	distances and angles	distances and angles
technique	manually	remote sensing (indirect daylight)	remote sensing (TOF*)	remote sensing (TOF*)
work on site	location dependent	location independent	location independent	location independent
installation	not relevant	not relevant	firm, without vibrations	firm, without vibrations
limitation	related to reference point	visibility, 2D: measuring in plane 3D: real spatial measuring	visible, free 3D point selection	visible, free 3D scan area selection
data	distances and dimensions	congruent image and coordinates	polar coordinates	intensities and polar coordinates
process	straight forward record	imaging and 2D/3D measuring	imaging and 3D modelling	imaging and 3D modelling
time factor imaging / modeling	high / low	low / medium - high	high / medium	low / high - very high
1st level model	2D sketch or plan document	2D: rectified image 3D: coordinates (image)	co-ordinates of discreet points (polar / cartesian)	co-ordinates in point clouds, with intensities
2nd level model		3D: **B-rep	lines (connecting co-ordinates)	3D: B-rep
3rd level model		3D: volume	3D: volume	3D: volume

* TOF: distance measuring method of 'time of flight' of the laser light.

** B-rep: boundary representation (polyline?)

5. Comparison of measuring methods for façade surveying tasks.

3.1.3. 3D Laser-scanning for TES projects: Possibilities and Challenges

The aerospace, automobile, and petroleum industries have exploited 3D laser-scanning techniques for the capturing of existing conditions of structures and objects for a number of years. Although the building industry has gradually started to see the benefits of the technology, the actual experiences are not well systematised. One of the exceptions is the General Services Administration (GSA), an agency of the United States government. The GSA Office of Design and Construction has had a program to introduce laser-scanning for the as-built/as-maintained condition of federal buildings since 2006 which aims to incorporate the data in building information models. The pilot studies include historic buildings and a 30-storeyed modern building.

The laser-scanning program is a part of the GSA's National 3D-4D-BIM Program, established in 2003. The program has produced a series of reports on the work, which are downloadable from the GSA web site at <http://www.gsa.gov/bim>.²⁰ Since the GSA is one of the few professional building owners and managers that has systematically used and studied the use of 3D laser scanning for facility management, it is highly profitable to take a closer look at their results. The following is excerpted from the GSA BIM Guide for 3D Imaging. The guide is today a de facto handbook – and the only one existing – for professionals who need to specify desired outcome of 3D imaging projects, such as building owners and architects/planners.

The relation of economic restrictions with rising precision of the specific surveying method was pointed out by Scherer.²¹ The economic decision to use laser-scanning systems versus other methods depends on several factors. The GSA has concluded that for jobs involving simple geometries and readily accessible work sites, 3D measuring systems may not be the best choice. However, if a high level of detail is required for complex geometries, the technology may be a viable alternative. (A traditional field of application are historic buildings that often have a huge amount of difficult ornamentation.) Viability is generated by the described fact of construction unevenness analysis, where 3D laser-scanning is the most powerful solution today. Thus, an important first step in the TES process would be to identify the contexts and projects in which the benefits of 3D imaging can be exploited. According to the experiences of the GSA (p. 2):

“There are other technologies (e.g., photogrammetry) as well as traditional surveying methods that may offer better or more cost-effective alternatives depending on the scope of work and the anticipated deliverables.”²²

Tender process and Objectives for the TES Process 3D survey

The experiences gained by the GSA in soliciting 3D imaging projects using laser scanning is of course also applicable to the soliciting of surveying in general independent of survey technology. According to the GSA, the detailed specification of every aspect of the desired outcome is the key to success (pp.2-3):

20 Published so far under the GSA National 3D-4D BIM Program are:

Series 01 – 3D-4D-BIM Overview

Series 02 – Spatial Program Validation

Series 03 - 3D Laser Scanning

Series 05 - Energy Performance and Operations

21 Scherer, Michael (2001) Objekterfassung: Was? – Wie? – Wozu?, Eine Analyse mit Schwerpunkt bei der Bauaufnahme, In: Flächenmanagement und Bodenordnung, 4/2001, pp. 188 – 199.

22 http://www.gsa.gov/gsa/cm_attachments/GSA_DOCUMENT/GSA_BIM_Guide_Series_03_R2C-a3-l_0Z5RDZ-i34K-pR.pdf, verified 24.08.2009

“First, the project team should clearly state the objectives for the 3D imaging project. It should identify the areas, surfaces, and objects which need to be imaged. A good understanding of the objectives is essential in helping the contractor design a scan plan (e.g., instrument locations, required resolutions) that maximises the product deliverable while minimising costs. Past experience has shown that it is critical to have no clear objectives as they will reduce future misunderstanding, the need for re-work, re-letting of the tender, and re-negotiation of the scope of work.

Areas of interest should be clearly identified and photos of these areas should be included in the solicitation. The type of features (e.g., cracks, architectural details) to be captured should be described in detail. It may also be helpful to describe how the data will be used (e.g., visualization, layout design, structural analysis) as it may give the service provider a better understanding of what is required. The areas of interest often require a higher level of detail and may result in more effort to obtain the required level of detail.”²³

The tender documents should also contain a detailed description of the desired end use of the 3D data. Past experience has shown that a qualified service provider who is well informed about the client’s goals is the best resource for developing innovative, efficient, and cost-effective methods to achieve the desired project objectives. Thus, a concise and clear description of the project objective(s) should be provided in the tender documents.

Typical critical points in the 3D geometrical survey in TES projects are:

1. The height and width of the façades (outer edges and corners)
2. The geometry of eaves and roof overhang
3. The exact location and dimensions of existing window openings
4. The exact level of structural parts that will serve as the basis for the fixation of the elements to the wall, e.g. concrete floor slabs in buildings with non load bearing external walls.
5. Issues such as the unevenness of the façade surface (including bumps or holes of critical size), curvature, and sloping walls (out-of plumb conditions).
6. The height of the terrain of the entire perimeter.
7. Reference height and horizontal level marked in the 3D image and in reality.
8. Fixed reference points on each façade surface and in the 3D image for the adjustment of TES during assembly.
9. Local coordinate systems for each façade plane

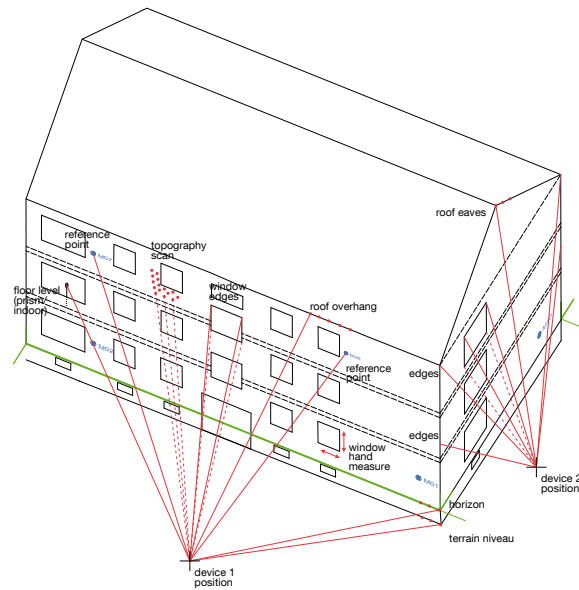

72. Critical points of a façade survey.

3.1.4. Reality Versus Model: Accuracy / Tolerances

In order to describe the relationship between the model measurements and the true values different authors use different concepts, such as “accuracy” or “tolerance”. For instance, the CCEM Retrofit Project uses the following definition:

“The required accuracy (1σ) is around ± 4 mm in the window areas and ± 7 mm in the roof / façade area.”²⁴

In addition to specifying the deliverables from the surveyor as to what should be scanned and modelled, the survey tender package should also include specifications of tolerances and minimum artefact size, which is the resolution of the scan. Minimum artefact size is the dimension of the smallest recognisable feature. Tighter tolerances and higher resolutions increase scan times and thus costs.

The GSA has defined a deliverable selection matrix in 4 levels according to expected resolution (minimum artefact size) and tolerances. At the most demanding level (level 4) the minimum artefact size is 13 x 13 mm with tolerance ± 3 mm (GSA, p. 5). The GSA (ibid.) defines “tolerance” as

“...the allowable dimensional deviation in the deliverable from truth (truth being a measurement obtained by some other means) in the specified co-ordinate frame. Some examples of tolerances are: 1) Point cloud: the distance between two points in a point cloud as compared to the true distance between the same two points in the actual scene should be less than or equal to the specified tolerance, 2) Plan: the difference between the length of a wall length in a 2D plan and the actual wall length should be less than the specified tolerance.”²⁵

²⁴ Gottwald, R. & Knabl, T. (2008) 3D Measuring for Building Refurbishment. In: Reporter. The Global Magazine of Leica Geosystems, 59, pp. 28-31.

²⁵ ibid.

	Photogrammetry**	Tacheometry*	Laser-scanning***
instrument accuracy	image scale, camera resolution	3mm + 2 ppm (distance without reflector), 0,3 mgon angle	4mm distance, 60 µrad angle
geometric accuracy*	± 6 mm in position, ± 10 mm in height (after bundle block adjustment)	±1,6 in position, ± 0,4 in height (reference are the fixed points of the survey grid)	Errors between 1-2 mm on average
model accuracy	user guided computation, depends on pixel resolution	discreet point measuring (acc. see instrument)	user guided computation
* according to example Rotlintstraße, Frankfurt.			
* Tachymeter, Leica TCRA 1100plus			
** Nikon D3, 12,8 MP CMOS sensor, resolution 4.256 x 2.832 pixels			
*** Leica Scanstation 2, dual-axis tilt compensator, 50,000 pts/sec, high precision (single measurement: distance: 4 mm, angle: 60 µrad)			

6. Table: Comparison of accuracy of different measuring methods.

The relationship between desired resolution and the distance between the measuring instrument and building should also be carefully considered (GSA, p.30):

“In general, the level of detail (resolution) that can be captured is reduced by increasing distance from the 3D imaging system. The reason being that the point density reduces with distance while the beam width increases (beam divergence describes how the beam width increases as a function of distance and is generally included in the instrument specifications). For example, if the beam width were 6 mm x 6 mm at 30 m, then identifying a feature size less than 6 mm would not be feasible with the instrument at this location. The instrument would have to be located closer to the feature or some other method should be used to achieve the desired resolution. Therefore, if a high level of detail is required in certain areas, the service provider will need to describe how this required level of detail will be achieved; for example, locate instrument closer to the area of interest and increase point density.”²⁶

Practical experience of accuracy

TES case study experience and the discussions with experts from surveying and timber construction leads to the conclusion of realisable levels of detail and tolerances.

It is necessary for an economic survey to differentiate between discreet points and random points in surface areas. Discreet points, e. g. window edges or corners, need a high accuracy of spatial distances (x,y,z) in the range of ± 7 – 10 mm.²⁷ Random points for the analysis of the topography have a lower level of detail. The scan grid of the façade surface is in a range between 20 – 50 cm. With a combination of different methods (e.g. TLS and TPS), it is possible to get fast, accurate and reliable results.²⁸

26 see also GSA BIM Guide Series.

27 Personal information from the industry partners of TES EnergyFaçade, S. Ambros, A. Gump, o.Lux, Trebyggerit.

28 Rauch S. (2008)

Construction Tolerances

prefabrication tolerances	± 5 mm
standards (DIN) façades	
tolerances of construction parts relevant in new building and renovation	
walls (e.g. DIN 18202, Tab.1 Z.2)	over 1m: ±16 mm; over 6 m: ±20 mm; over 15 m-60 m: ±30 mm
openings (e.g. DIN 18202, Tab.1 Z.5)	over 1 to 3 m: ±12 mm
angle deviation (bow dimension)	over 1 m: 8 mm; over 3 m: 12 mm; over 6 m: 16 mm; over 15 m: 20 mm; over 30 m: 30 mm

7. Table: Required prefabrication tolerances and general building standards.

3.1.5. Digital Workflow

The TES process is envisaged as a frictionless information flow of digital data from the documentation process to design and engineering; later to element prefabrication and site assembly – and finally that the digital data accumulated through the TES process can be used in the future management of the facility. All through the process the same data is re-used and enriched by the various participants. This “digital chain” is a continuous digital and seamless organisation process right from the acquiring of data in documentation to construction.²⁹

Interoperability

The frictionless exchange of data between the various parties in a construction project has been a major theme of discussion since 2004 when the National Institute of Standards and Technology (NIST) in the USA performed a study of the additional cost incurred by building owners as a result of inadequate interoperability which were shown to amount to around 20 % of the total building cost. There are several reasons for this, caused mainly by the fact that the various stakeholders exchange data in paper format, which then must be re-entered into the next party's software. This slows the process and is a major source for errors to enter into the project.

There are two primary approaches which aim to integrate the digital process:

1. To stay within one software vendor's products
2. To use software from various vendors that can exchange data using industry supported standards.

The second approach uses either proprietary or open-source, publicly available, and widely supported standards created to define parametric building objects (In-

29 Dohmen, P. & Rüdenauer, K. (2007) Digital Chains in Modern Architecture. In: Kieferle, J.B. & Ehlers, K., *Predicting the Future. Proceedings of the 25th Conference on Education in Computer Aided Architectural Design in Europe (eCAADe 25)*, pp. 801-804.

See also the website of the Laboratory for Architectural Production (LAPA of the Federal Institute of Technology in Lausanne (EPFL), in particular: <http://lapa.epfl.ch/Jahia/site/lapa/pid/66408/cache/off/>

dustry Foundation Classes or IFCs). These standards may provide a mechanism for inter operability among applications with different internal formats.³⁰

Building Information Modelling (BIM)

Object-oriented CAD systems have replaced 2D symbols with building elements (objects), capable of representing the behaviour of common building elements, e.g. walls with length, height, thickness and openings as well as functional and technical properties. Capturing such relationships and behaviour are not possible in the earlier CAD standard. In a Building Information Model (BIM) all the intelligent building objects that combine to make up a building design can coexist in a single project database (or “virtual building”) that captures everything known about the building. A Building Information Model should provide a single, logical, consistent source for all information associated with the building.³¹

Because BIM relies on machine readable representations, data from virtual models can be used in many ways. Among these benefits are spatial conflict checking, consistencies within drawings, automatic generation of bills of material, energy analysis, and cost estimation. Other benefits include the integration of these analyses to provide feedback for architects and engineers from other disciplines to inform them on effects of alterations of designs, while designing, rather than checking.³² Both practical experience from real-life projects as well as academic studies today confirm the great benefits of BIM to create more sustainably built structures, more efficiently and more cost-effectively.³³

A major challenge for the TES process in relation to BIM is that current BIM software can only handle detailed architectural work related to existing buildings, for instance walls out of plumb and other irregularities only with uneconomical modelling effort. The creation of components in some BIM software packages are time-consuming tasks.³⁴

30 Eastman, C., Teicholz, P., Sacks, R. & Liston, K. (2008) *BIM Handbook. A Guide to Building Information Modelling for Owners, managers, Designers, Engineers, and Contractors*. Hoboken, New Jersey: John Wiley & Sons; p. 15.

31 Howell, I. & Batcheler, B. (2005) *Building Information Modelling Two Years Later*. The Laiserin Letter, May 2005. www.laiserin.com

32 Morad, S. (2008) Building Information Modelling and Architectural Practice: On the Verge of a New Culture. In: *First International Conference on Critical Digital: What Matters(s)?*. Harvard University Graduate School of Design, Cambridge (USA); pp. 85-90.

33 Mitchell, J., Wong, J. & Plume, J. (2007) Design Collaboration Using IFC. A Case Study of Thermal Analysis. In: *Proceedings of the 12th International Conference on Computer Aided Architectural Design Futures*, Sydney (Australia); pp. 317-329.

34 Mr. R.P. van Kersbergen (17.06.09); see note 5 and Mr. Hossein Nasser, GSA, Washington DC (17.06.09)

BIM and TES?

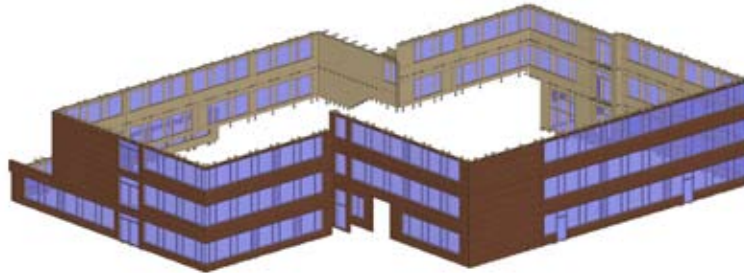

73. 3D model of the timber fabricator providing the façade for Realschule Buchloe, produced in July and assembled in August 2009.

When geometrical digital models only contain 3D data and no object attributes, they cannot be defined as a “Building Information Model”. “These are models that can only be used for graphic visualisations and have no intelligence at the object level. They are fine for visualisation but provide no support for data integration and design analysis.”³⁵ On the other hand the geometrical data can be computed and analysed itself. This gives the opportunity to achieve all necessary information for a geometrically correct manufacturing.

Eastman et al. believe pure geometrical models are not essential for design analysis. However in renovation projects geometrical models of the as-built situation are part of the design and are a necessity to solve technical questions in renovation, as described in the RE approach. For example an analysis of the surface topography gives information on the topology of old and new parts of the façade. Additionally the results provide data for engineers on possible fixation positions and load parameters. The digital model also records the substance hidden behind the new TES EnergyFaçade throughout.

To date, little documented evidence exists as to the use of BIM in building renovation. However, one study done by Finnish researchers shows interesting possibilities in parametric 3D modelling in building renovation where an eight-floor office building in Helsinki formed the case study.³⁶

For the TES manufacturing the surveyor will provide a digital 3D model (without object attributes) to the designer or the contractor, using a file format such as for instance DWG - format or an open documented format such as STL.³⁷

35 Eastman et al (2008), p. 15.

36 Rajala, M. & Penttilä, H. (2006) Testing 3D Building Modelling Framework in Building Renovation. In: *24th eCAADe Proceedings, Volos (Greece)*, pp. 268-275.

37 Bosche F., Haas C.T., Akinci B. (2009) „Automated Recognition of 3D CAD Objects in Site Laser Scans for Project 3D Status Visualization and Performance Control“, *ASCE Journal of Computing in Civil Engineering, Special Issue on 3D Visualization, Volume 23, Issue 6 (to appear)*.



74. 3D wireframe model of the Realschule Buchloe was basis for the product model of the timber fabricator, surveyed in June 2009.

Finally the result of the survey should measure up the requirements of the entire design, engineering and production team. Therefore the different possibilities for final 3D images and 3D models are as follows:

- Fully registered and cleaned high density (HD) point cloud of the façade as a result of a 3D laser-scanning (ready for reverse engineering). An addition of the interior is possible. The 3D image is a representation, like a mould, of the existing façade. Openings and assemblies are remodeled by geometric or parametric representatives which are adjusted to the PC.
- 3D wireframe model of the façade derived from one of the measuring methods described above. It is an interpretation and idealisation of the 3D survey data. Further information on the façade topography is necessary.
- 3D surface model - an enhanced version of the wireframe with a triangulated façade surface. This could be a close to reality solution, if the resolution of the meshed surface is high enough.
- 3D volumetric model also parameterised with interior surfaces based on a point cloud (highly sophisticated post-processing and modelling process required and the model will stay a simplified interpretation of the existing object). Additional information like façade topography is necessary.

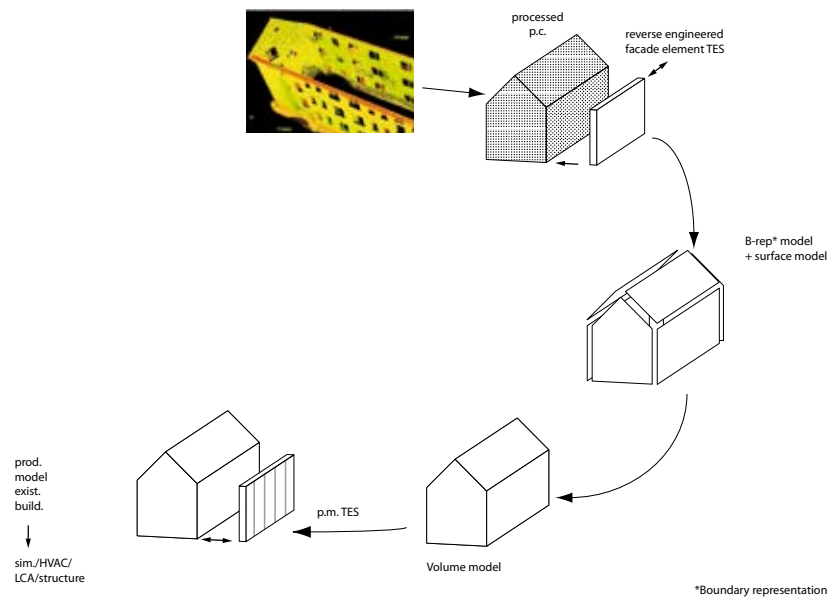

75. Step by step development of a product model (BIM) from survey data.

The fabricator will need at least geometrical data from the designer for the production of elements, including importation of the data from the designer's 3D CAD model into their CAD/CAM software in a convenient file format, e.g. STL or IFC. Experience shows that fabricators in the European timber building industry are reluctant to import a 3D model and use this directly for the creation of the production codes in the CAD/CAM software. Due to the lack of 3D design models from architects most fabricators prefer to build the model from scratch in their own software to ensure that it is consistent with their fabrication requirements. Similar experiences are also documented among steel structure fabricators in the USA.³⁸ In a study of BIM data exchanges of precast concrete fabrication, Jeong et al. (2009) observe that when contract drawings are completed before a fabricator is selected, building components seldom incorporate fabrication process considerations during the architectural design stage. As a result fabricators must duplicate work as they need to regenerate the detailed documentation required for fabrication and erection.³⁹

The above-mentioned experiences show that integrated collaboration between designer, fabricator, and contractor throughout the design process is of vital importance to speed up projects and thus make projects more cost-efficient. In the ideal scenario where the designer exports the 3D model to the fabricator, the fabricator is completely safe concerning the consistency of the model, and consequently can directly adopt the model for his CAD/CAM software without changes. Therefore a step-wise use of BIM for TES is the proposal for the development of a product model.⁴⁰

38 Personal information from professor Chuck Eastman, Georgia Institute of Technology, Atlanta, USA (18.06.09)

39 Jeong, Y.-S., Eastman, C.M., Sacks, R, Kaner. I. (2009) Benchmark tests for BIM data exchanges of precast concrete. In *Automation in Construction*, 18, 2009, pp.469-484.

40 Schleinkofer M., Schäfer T. (2005) Vom Laseraufmaß zum Produktmodell für Altbauten. Abschluss Symposium des BayFORREST-Forschungsverbundes „Stoffflussmanagement Bauwerke“ Zum Thema „Nachhaltigkeit bei Planung, Nutzung und Sanierung von Bauwerken“, TU München, 15. Sep. 2005.

When a new geometrically, identical envelope is applied to an existing building only the new elements and the existing façade surface with openings should make use of BIM intelligence. The bigger the extent of the retrofit, the more complex the model will get and the benefit-cost-ratio will decrease for the whole project.

Another solution coming onto the horizon is the integrated capability of the handling of huge point cloud data in CAD and BIM software. The construction software industry recognised the growing application of survey based geometry data. The step from specialist tools into the broad market opens the world of reverse engineering to the construction industry. This development is well overdue as the refurbishment market in the EU has continually grown over the past two decades and with it the demand for such tools. Mechanical engineering and dental restoration already profit from the use of RE for the fabrication of individual components, which have to fit precisely into random gaps or on irregular surfaces, e. g. occlusal surfaces. A point cloud accessible in construction software facilitates an adaptation of a planar TES layer onto the uneven 3D image of the façade. Fitting windows right in their position in the virtual model and narrow the physical gap between old substance and new elements are basic operations. The main benefit results in a lean process by making post-processing unnecessary.

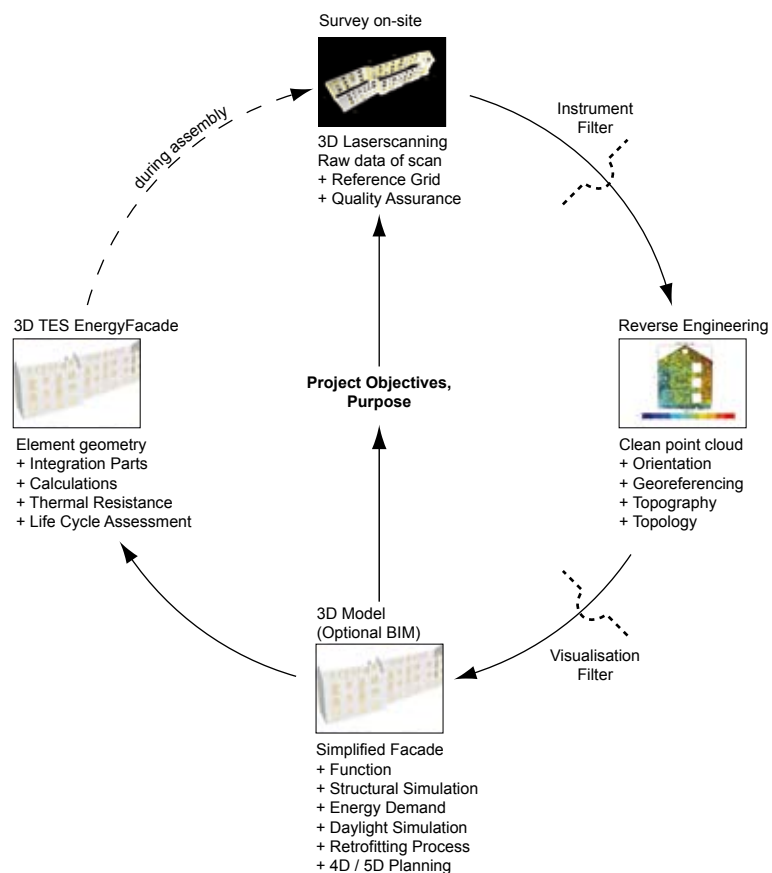

76. Necessary steps of a TES survey campaign based on Scherer's paradigm.

The surveyor provides only a registered, cleaned and geo-referenced point cloud with following consequences:

- Filtering and interpreting of data is obsolete
- High definition point cloud as "mould" for adaption of TES elements
- Fast and interactive element adaption
- Operation and control by construction expert

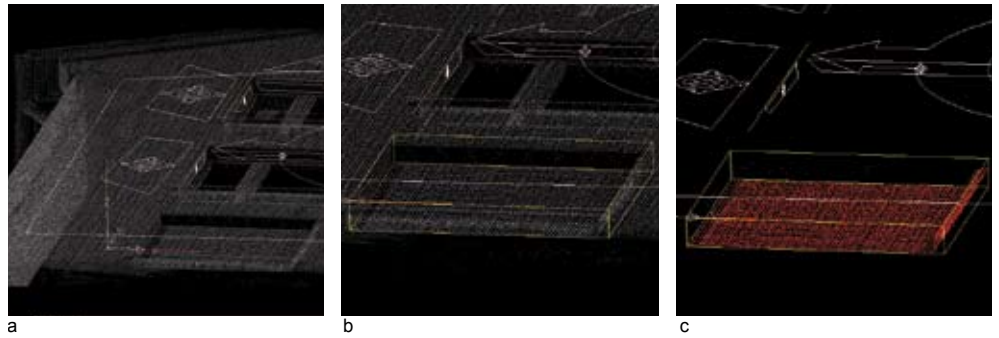

77. (a) Definition of a façade plane, (b) insertion of volumetric solids in the position of a window opening, (c) collision control between pointcloud and solid. Continuation of the iterative process by further adjustment and collision control.

The complexity and the amount of requested data influences the economic perspective of the application of the survey and the entire modernisation method. The diagram below shows a qualitative benefit-cost ratio using combinations of modern and traditional measuring techniques. According to the experience in the case study the required preciseness and complexity can be solved by a tacheometrical survey completed with photos and hand measurement. The related costs with 2,50 to 4,00 €/m² for an entire 3D façade model are affordable compared to costlier methods like 3D laser-scanning.⁴¹ The direct 3D survey data use and façade element modeling approach described above may be a future perspective for an affordable use of laser-scanner data in digital workflow. The Laser-scanning method gets cheaper and more efficient each year. The 3D laser-scanning hardware has shown a reduction to nearly the half of the market prices compared to the prices at the beginning of the two years research project.

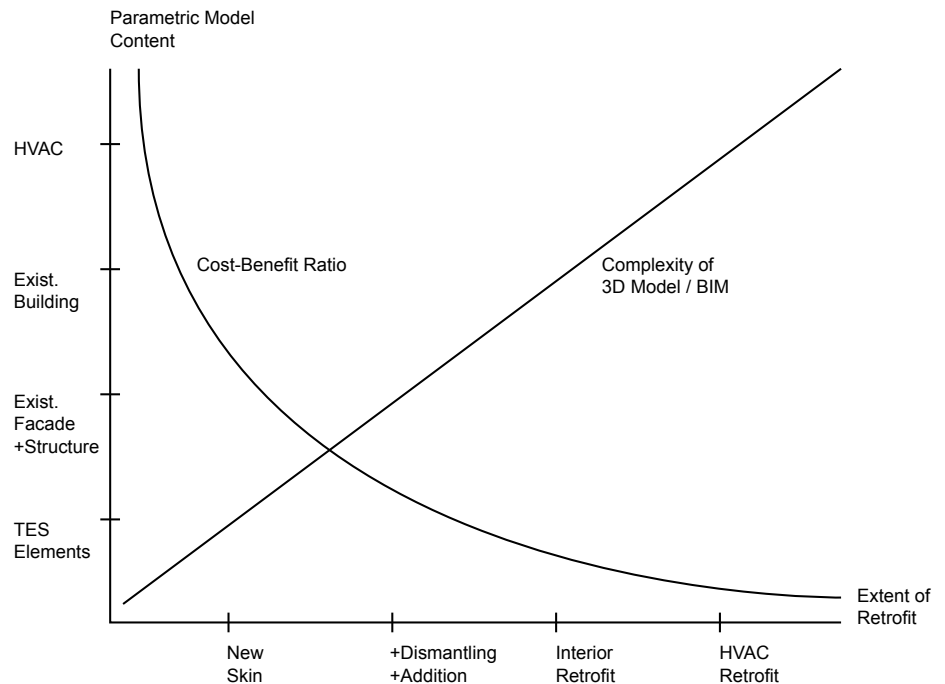

78. Criteria and relation cost - complexity of 3D models.

41 Prices per surveyed square meter facade are according to German market survey on several surveying companies in the years 2008 and 2009.

3.1.6. Case Study of a Façade Survey



79. Case study building from the 1950s located in Frankfurt, Germany.

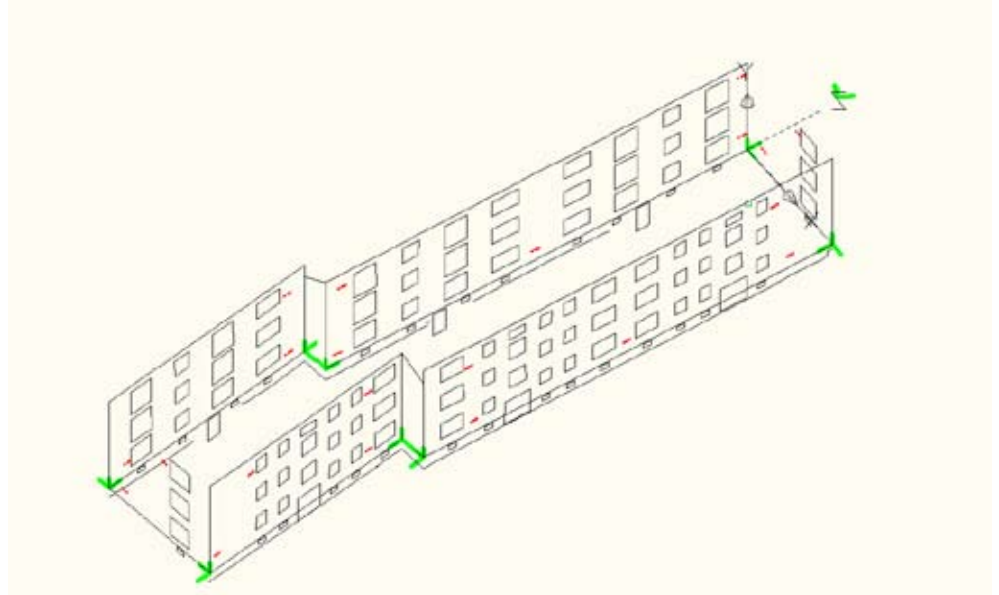

80. 3D Wireframe model of Rotlinstraße, Frankfurt.

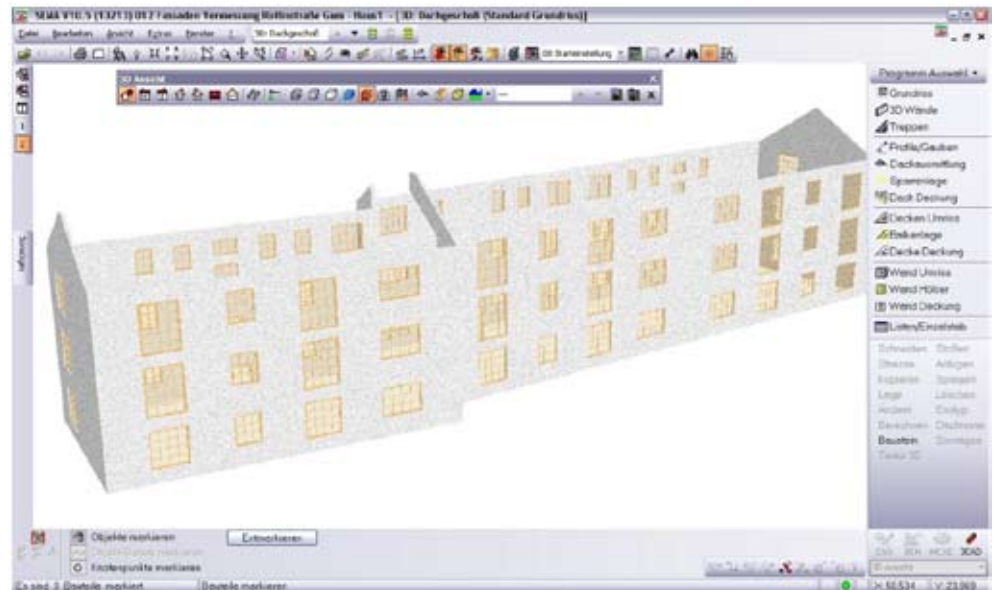

81. 3D parametric model in SEMA after importing and postprocessing the wireframe model.

Experience for this traditional approach in project organization was gathered with a demonstration object, the renovation project of ABG Frankfurt Holding in Rotlinstraße, Frankfurt, funded by Hessisches Ministerium für Wirtschaft. The design was undertaken by the architectural office of Faktor 10, Darmstadt, and the engineering was supplied by bauart konstruktions GmbH & Co. KG, Lauterbach. The aim was to examine today's digital measuring methods and tools to ensure the frictionless digital chain. The first step was a survey based on the so called hybrid methodology of the Department of Geodesy, Prof. T. Wunderlich, TUM, who gave his expert support to the project. The acquisition of the 3D imaging raw data was done with tacheometry, 3D laser-scanning and 3D photogrammetry. Additional handmeasuring was done to add missing discrete points in the area of the window sill. These points were not visible for the laser beam of the measuring devices

because of shading. A 3D wireframe model of the façade geometry with the cut off window openings was processed with discreet surveying software tools (*Rollei Metric®*, *Leica Cloudworx® for AutoCAD®*). The 3D wireframe façade model was finalised with *Autodesk® AutoCAD® Architecture* and provided as a DWG file together with oriented and rectified images in the TIFF file format.⁴² The images provide an additional, much more detailed elevation of the façades and a full and geometrically correct documentation of the existing façade.

In a further step the model of the renovation object was handed over to the timber construction software tool *SEMA Experience*. Furthermore, support was given by the software developers from *SEMA Soft*.⁴³ The import of the 3D wireframe model into the parametric CAD/CAM software was without loss of data. Finally the wireframe was processed manually into a volumetric / parametric model with window openings and wall attributes. The volumetric model now works as a reference object onto which the new TES façade is adapted to.

Digital surface model (DSM):

A DSM normally provides a digital representation of the topography of the ground level including all data such as vegetation and buildings etc.

Contour Line Model (CLM):

A CLM consists of the resulting set of contour lines originating from virtual horizontal sections through a DSM.

There was in addition a need to evaluate the irregularities of the façade. The deviation of the façade planes is easier to recognise in surface models than in abstract, minimised wireframe models. The method to generate a surface model of the topography of the façade is derived from geodesy applications. The computation of a digital surface model (DSM) and a deliverable as a contour line model (CLM) is a method tested in the TES project. Surface models are applied on high-resolution 3D images of vertical façades. The basis of this model is a triangulated irregular network or a rectangular grid calculated by approximation. The raw data for the 3D image can be acquired with all three described close range remote-sensing methods. However 3D laser-scanning is the only automated method providing enough automated and randomly measured single points of façade areas in order to compute a detailed DSM. The rasterised grid has a recommended resolution of 10 – 50 cm. The measured façade surface points will be computed with an appropriate stepping of height of 5 mm for the contour lines.

Each façade elevation has its own DSM containing a subset of surface points. The elevation is based on a defined local coordinate system with a horizon and a basic reference point for this elevation. The defined horizon gives the horizontal direction (X dimension), and additionally defines the corresponding vertical direction (Y dimension) and the depth as the third orthogonal direction (Z dimension).

42 TIFF = Tagged Image File Format, a non-lossy digital image file format. The used format was the GeoTIFF, an enhanced metadata version of plain TIFF with georeferencing data to be embedded in the image file. The spatial reference is information about map projection, coordinate systems, datums etc.

43 Personal information and report from Mr. T. Pfluger, SEMA Soft GmbH, Wildpoldsried, a software company providing parametric CAD / CAM solutions for the timber construction industry (<http://www.sema-soft.de>).

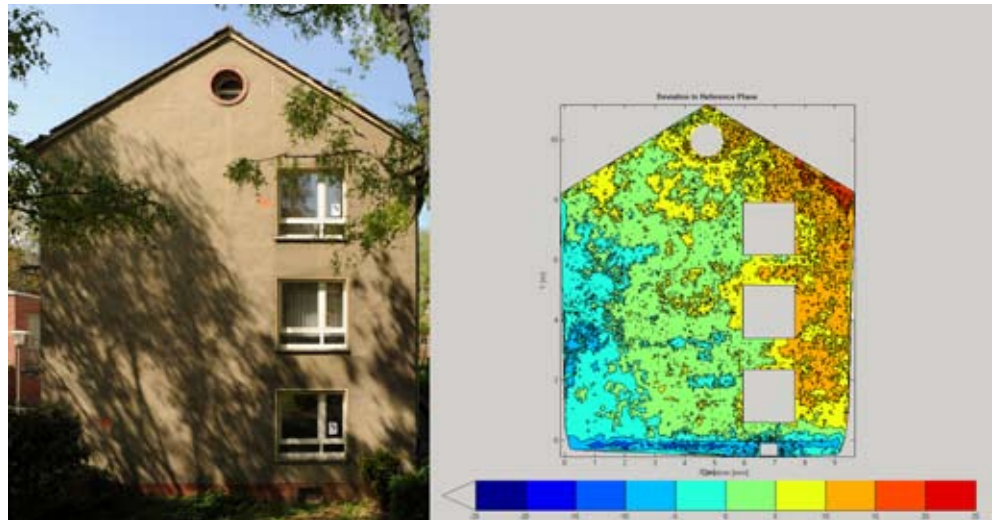

82. Rectified image (left) and digital surface model (DSM) of the façade (right), showing the topography in different colours (deviation to perpendicular to reference plane - each colour corresponds a 5 mm step in height).

Direct data acquisition workflow

Building processes in contractor models are profiting from a more straightforward data workflow. The following example is just a theoretical model based on the capabilities of the integrated software *cadwork*.⁴⁴ It is based on the capabilities of a realtime connection of a totalstation with the *cadwork* software, controlling the surveying and collecting the data. There is also the possibility to operate with coarse point clouds from 3D laser scanning with some ten thousands of measuring points. Postprocessing work still has to be done after the survey. Tools like this, with direct connections to surveying instruments provide a strong and seamless workflow for manufacturers / contractors.

A short review shows rapid development in the 3D imaging methods driven by the demand of the multimedia and movie industries which use these tools excessively. For example there are now multi-image photogrammetry software tools, that compute dense point clouds out of object images⁴⁵ The low resolution in depth may be a hindrance for photogrammetry as is the problem of the integration of interiors. Otherwise the performance of these tools has to be proven for the application in the TES process.

Summary

High precision remote sensing provides cost efficient methods for surveying the building stock. The acquired data is of good quality and allows its use in prefabrication. There are high requirements in terms of tolerances and content to prepare useful surveying results for retrofit. In consequence post-processing the survey data into an abstract 3D wireframe is a costly and responsible task. Summing up the conclusions, modern surveying methods combined with reverse engineering methods are a necessity in retrofit projects. They can optimise the workflow, enhance the robustness of the TES method and facilitate the application of prefabrication in retrofit projects.

⁴⁴ Personal information from Mr. C. Levers, from *cadwork informatik Software GmbH*, Hildesheim, providing the identically named 3D CAD / CAM tool. <http://www.cadwork.com>

⁴⁵ <http://www.menci.com/zscan.html>; <http://www.photomodeler.com/products/pm-scanner.htm>, verified 20.04.2010.

3.2. Environmental Impact and Life Cycle

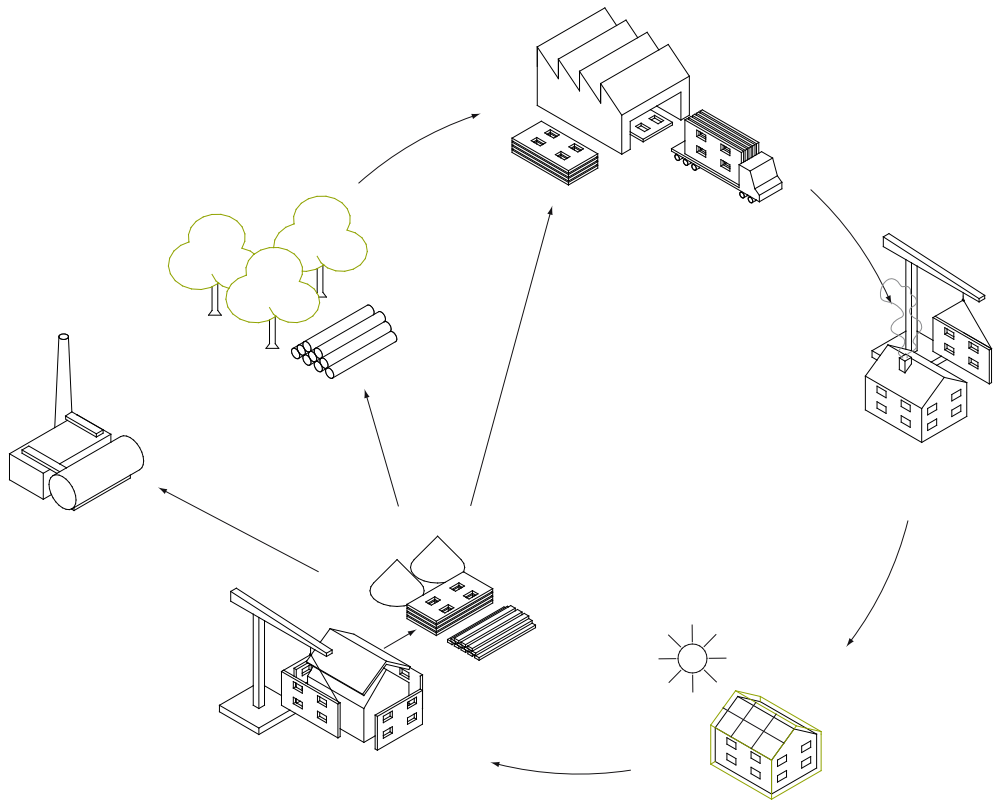

83. Product life cycle of TES EnergyFaçade. The main construction material is mainly timber based and can be reused or easily recycled at its end of life.

“Construction changes the environment. Therefore it is necessary today to optimise buildings at their construction, referred to cost, energy consumption and environmental impact”.⁴⁶

Paradigm of Sustainability

The environment is the basic system on which mankind is dependent according to the definition of sustainable development, first mentioned in the “Brundtland-report”: “Sustainable development is development that meets the needs of the present without compromising the ability of future generations to meet their own needs”⁴⁷. In order to support future development environmental protection becomes necessary.

This societal model was translated into a system representing three main perspectives for the protection of man: economy, environment and society⁴⁸. This so-called “Three Pillars Model” formed the basis of the sustainability debate up to now.

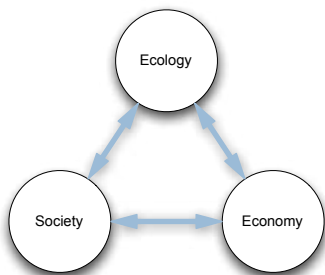

84. The three pillars analogy of sustainability.

46 Original citation: “Bauen verändert die Umwelt. Deshalb ist es heute notwendig, Bauwerke bei ihrer Erstellung in Bezug auf Kosten, Energieverbrauch und Umweltbelastung zu optimieren”. <https://www.crb.ch/go/crbinternet/3617/de/DesktopDefault.aspx>., verified 23.11.2009.

47 Brundtland, G. H. (1987) first published 1987; http://en.wikisource.org/wiki/Brundtland_Report (31.08.2009).

48 concept of the Three Pillars Model.

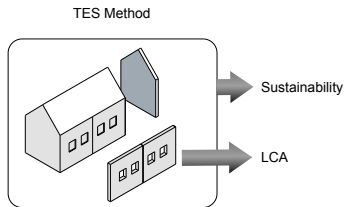

85. System borders for sustainability and LCA of TES.

In other word and translated for application in the construction industry, there are some essential performance based criteria which have to be taken into consideration, as mentioned by Rudolphi⁴⁹:

“conservation of the eco-system
 conservation of natural resources
 conservation of human health
 conservation of social values and public goods
 preservation of capital (investment) and conservation of material goods”.

by a:

- Minimised footprint of an intervention
- Passive system behaviour during operation
- Optimised use of resources from cradle to grave
- Optimised user comfort and avoidance of harmful substances in construction products
- Social responsibility
- Economic solution referring to lifecycle

The “three pillars model” is adopted for the building sector as a common basis, which will be regulated by the CEN TC 350 for the forthcoming EN 15643⁵⁰. The sustainability of buildings is described through this standard and this information is available for comparison and optimisation of lifecycle performance. The environmental aspect can be described by the application of a life cycle management of the renovation project resources.⁵¹ Other aspects, such as the economic ones, can be quantified with a life cycle cost (LCC) analysis⁵². Social aspects as yet have no definition, rather a general quantitative assessment catalogue at the moment. They are described in an ideal and qualitative form. However there are aspects that can be counted and calculated such as the user comfort or architectural quality.

A building not only has to fulfil technical or functional requirements e. g. energy efficiency. In order to meet the goal of sustainable building a trade off between the three aspects has to be found and established in a future oriented design solution. The trade off is a balance between the often contradictory aspects of economy and society under the hegemony of ecology. Ecology has to be the dominating aspect, because it is the basic condition for economy and society.

Integrated Product Policy

looks at all phases of a products' lifecycle and considers all stakeholders, in order to minimise environmental impact of goods.

End-of-Life (EoL)

“is a term used with respect to a retailed product, indicating that the product is in the end of its product lifetime and a vendor will no longer be marketing, selling, or promoting a particular product and may also be limiting or ending support for the product”. <http://en.wikipedia.org/>

49 Rudolphi, A. (2009) Lebenszyklusanalyse von Bestandsgebäuden; in: Sick, F. (ed.): 3. Internationales Anwenderforum Energetische Sanierung von Gebäuden, Ostbayerisches Technologie-Transfer-Institut, Kloster Banz, Bad Staffelstein 27.03.2009; Regensburg; 2009.

50 prEN 15643-1:2009 and prEN 15643-2:2009

51 DIN EN ISO 14040 and DIN EN ISO 14044

52 DIN 18960

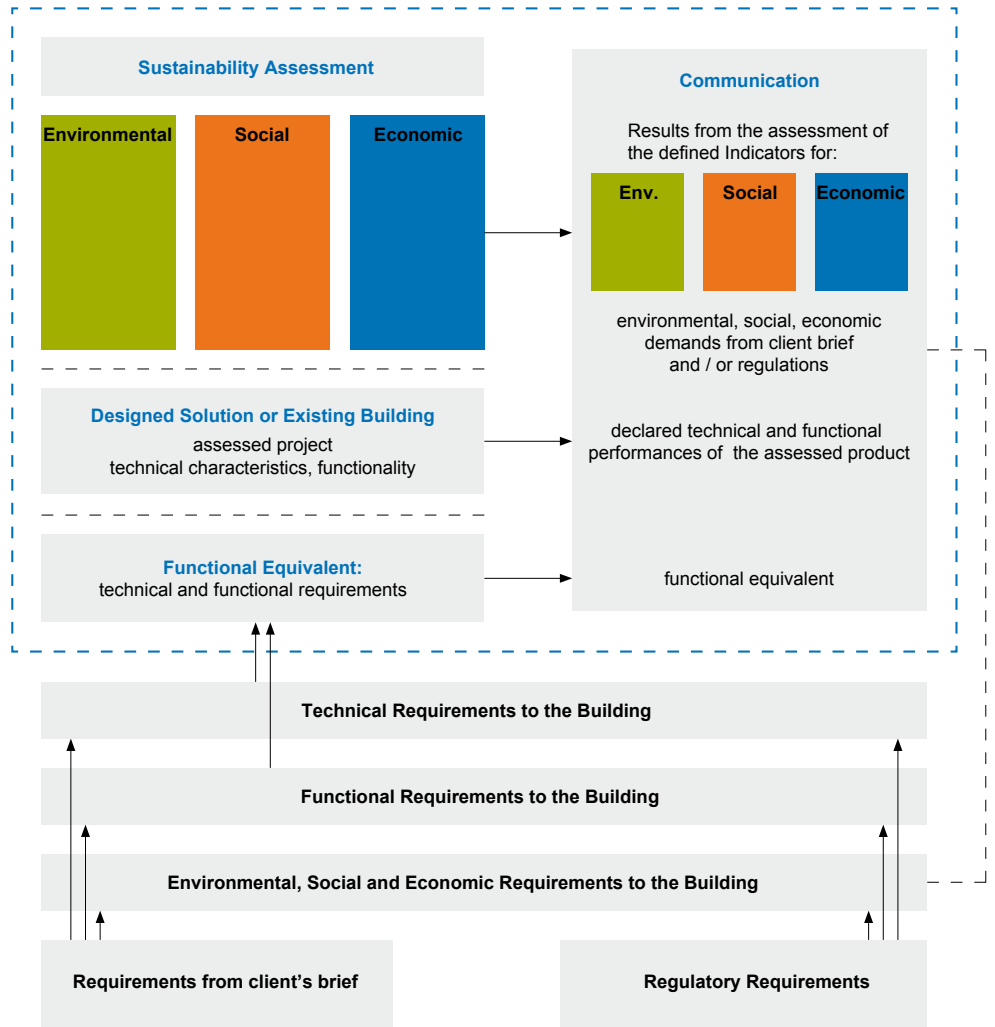

86. Concept of description of sustainability due to CEN / TC 350 as basis for the EN 15643.

Sustainable TES

A TES modernisation covers aspects from conservation of resources to long term economic valuation and positive cultural and health aspects. The retrofitting project has to be defined and developed in respect to its life cycle otherwise it will not fulfil the central demand of the concept of sustainability.

There are two constituting factors in retrofit projects, which will guarantee the success and the quality of sustainability. First there is the entire existing building

which works as an independent system or self-contained organism. It is the host system for the new TES EnergyFaçade. The host has construction assemblies that will be disposed of, like the old façade or parts of it. The host system defines necessities for the guest system. The overall quality of the entire object is evaluated with benchmarks of the operation phase like the heat energy demand per service area or the airtightness of the building hull.

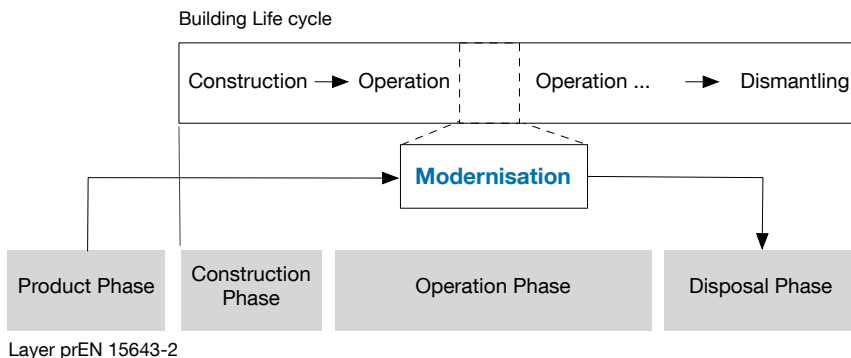

Layer prEN 15643-2

87. Lifecycle of an entire building and lifecycle of modernisation products.

The guest system or the assembly TES element has to be evaluated in several stages of its product life. On one hand the TES method has to generate added value for the client and society. The economic and social benefits have to be evaluated dependent on the constraints of each object. On the other hand it proposes a façade retrofit product. Its materialization can be assessed throughout the entire life cycle from production, assembly and installation to maintenance and after use by disposal/recycling.

Environmental Impact

TES EnergyFaçade consists to a high degree of renewable resources. This fact improves the environmental properties as compared to other façade retrofitting systems, that are based primarily on non-renewable resources. A TES Energy-Façade consists of different functional layers, each of which can be varied according to requirements of fire safety, durability or design. Hierarchy and selection of layers primarily depends on functional criteria as well as rational combinations. However also alternatives with minimised environmental impact have to be thoughtfully chosen.

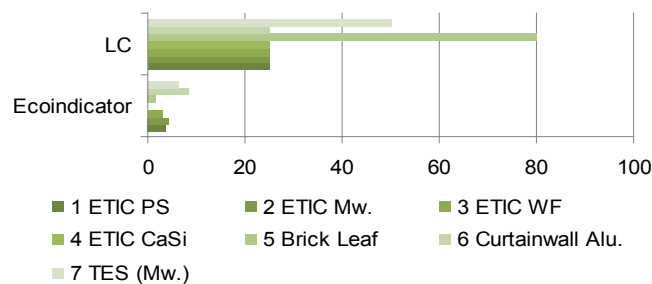

88. Typical technical lifetime of different façade modernisation systems and the related eco-indicator
99.

The optimisation of the kind and the amount of materials has to be undertaken with methods of lifecycle assessment (LCA). The resulting impact factors of the different material combinations will give recommendations on the most environmental and sustainable solution. Additional aspects - primarily concerning the life cycle - should also be taken into consideration. These include cleaning, maintenance, repairability, modularity, exchangeability and the End-of-Life. Here one finds a wide range of optimisation possibilities which also take into account economic viability and the durability of the outer leaf of the façade.

Finally the system borders of the TES element have to be examined to enhance resource efficiency. The necessary construction parts consist of fixations, joints and adaption layers. For the fixation of TES elements steel parts are typically used. They contribute an exceptional high amount of non-renewable resources and primary energy, thus an optimisation of the fixation construction is essential. The same applies to the building of joints and the adaption layer. Besides the TES element itself, additional assemblies built into the platform must also prove their suitability with regard to ecological impact and their contribution to an optimisation of the energetic properties, e.g. windows. In addition their compliance with criteria 1 to 3 must be checked, as well as whether they can be integrated into the platform without any decrease in system quality.

Carbon Dioxide Emissions in Construction

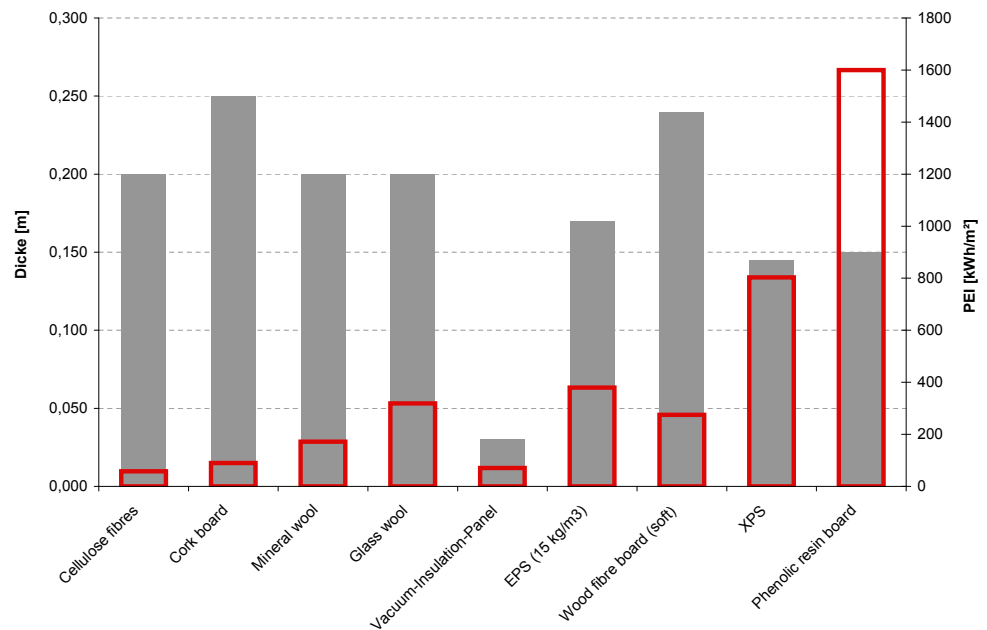

89. Specification of different insulation materials concerning heat conductivity and primary energy intensity (non-renewable). The thicknesses of insulation is standardized to a U-value of 0,2 kWh/m² in this case. The red boxes show the contained primary energy (PEI) per m². The data is based on the Ökobau.dat delivered by German Federal Ministry of Construction.

Rudolphi:

“Selbst bei einem Rückbau bis auf den Rohbau ist zu berücksichtigen, daß allein der Stahlbeton-Rohbauanteil in einem durchschnittlichen Neubau am Primärenergieaufwand und an den globalen Umweltwirkungen (Treibhauseffekt GWP, Versauerung AP, Eutrophierung NP usw.) in der Regel zwischen 50 und 70 % beträgt.”

Even at a dismantling to the shell construction there is to consider, that the steel and concrete shell share in an average new building usually accounts to the primary energy demand and the global environmental impact (Global Warming Potential GWP, Acidification Potential AP, Eutrophication Potential NP, etc.) between 50 and 70 %. (translated by author)

An insulation material should also avoid carbon dioxide emissions whenever it is possible. A careful look at the amount and ecological quality of insulation material is therefore necessary. There is a big difference in the amount of primary energy from non-renewable resources needed to produce this insulation material. This has consequences for materials environmental impact, i.e. carbon footprint. There is also a difference in the efficiency of the materials. The thickness of insulation material needed to reach a minimum U-value of 0,2 kWh/m² depends on the heat conductivity of the material. This defines the total amount of insulation material needed. The comparison between several insulation materials from renewable and non-renewable resources shows the performance in respect to the environmental impact. The environmental impact should be a strong selection criteria nowadays and helps to reduce carbon footprint of any construction activity including retrofit.

The important role of the existing substance for the environmental protection is clearly shown by the figures presented by Rudolphi.⁵³ Over 50 % and up to 70% of the global environmental impact of a building is concentrated in its construction. There will be a quantifiable amount of material that has to be dismantled and disposed during the modernisation of a building. Additional there is an amount of new (façade) components that will be added to the existing construction. Hence the material masses of waste and new components have to be balanced.

The shell construction of the building stock is an excellent example of Carbon Capture and Storage (CCS) when looking at it in the retrofit phase. Concrete or steel production is responsible for a serious amount of CO₂ emission. Nowadays the more of a buildings substance is kept the higher the benefit for resource and energy efficiency by simple reuse. This is the passive part of CCS together with the existing substance.

An example of active CCS is the use of renewable resources as construction

53 Rudolphi (2009).

material. A change of the state or condition of the material or product by harvesting, production, recycling etc. needs a certain energy input. Carbon based renewable resources capture carbon and stores it over the entire life cycle of the product. For example one cubic metre of dry timber contains 250 kg of carbon. Thus 1.000 kg CO₂ which is absorbed per cubic meter of wood. The energy content of one cubic meter of wood is around 9.500 MJ. Only 60 % of the raw materials energy content is needed for process energy in the production of 1 m³ of laminated timber, the remaining 40 % is stored in the timber construction until its disposal⁵⁴. If the product is reused or recycled it saves the energy bonus. Finally the thermal utilization exhausts the carbon bonus but also releases valuable heat energy.

In short the benefit of an intensified use of wood, combined with sustainable forestry, uses the construction material timber as carbon storage and the new planted trees as carbon capture. This intensifies the reduction of GHG emissions and contributes to a decrease in GHG concentration in the atmosphere.

Life Cycle Assessment in Detail - Product Durability

The age of an existing construction is in close relationship to its durability. The robustness of the constructions, rather than the construction materials alone, is the key issue, when long life time and ease of maintenance is the central focus. There are complementary concepts in building age consideration. The first concept is the “technical lifetime” or product durability of the construction; the second is the “service life”. Technical life describes the life of the building from erection until demolition. It normally ends, when a retrofitting is no longer financially viable (except from a cultural heritage perspective), due to security risks or constructional deficiencies - for example structural problems. Service life describes the period of normal usage of a building while regular maintenance is possible without substantially conflicting with the demands of the users and service and maintenance costs are lower than the revenue from rent.

The service life can be prolonged by modernisation, especially when there is a predicted remaining technical lifetime of the shell construction. Basically a high durability in construction and the used materials is the most effective measure to ensure a long technical lifetime. With respect to life cycle thinking it is also one of the most influential levers to reduce the environmental impact of buildings.

Timber and timber based façade retrofit products have to be manufactured according to the recommendations of standards and quality assurance processes. Timber constructions have to be designed and erected according to the regulations for timber preservation following the rules of preventive constructional measures in buildings (e.g. DIN 68800-2). Thus the durability is ensured, on the assumption that there is a normal use of the construction. Dry and protected timber can reach very long technical life spans up to 100 years and even more, this can be observed best in historic buildings.

LCA in TES and Building Stock

Compared to a new building, the modernisation of the building envelope includes different challenges due to a pre-existing technical and functional system. An existing building is a conglomerate of spaces, structures and materials. Everything has to be surveyed and documented and the consistency of many construction details will have to be assumed because they cannot be disassembled.

Standards

LCA: EN ISO 14040, 14041, 14042, 14043

LCC: e.g. DIN 18960 Nutzungskosten von Hochbauten

EPD: prEN 15804, EN ISO 14025

Design Lifetime: expected lifetime according to design parameters

Product Durability: actual lifetime of a construction

Service Life: acceptable period of use in service, where costs of use are lower than revenue.

TES EnergyFaçade has an impact on the environment:

1. Construction materials have to be produced.
2. Existing parts are disposed of, or are recycled and reused (only in modernisation).
3. Elimination of toxic or other harmful substances.
4. Façade elements are fabricated and mounted.
5. During the operation phase of the building (maintenance).
6. End-of-Life of TES EnergyFaçade (disposal, recycling, reuse).

Balancing all inputs and outputs of fabrication, use and disposal of a product over a defined period of time is the most important quantitative approach. Considerations focus on three main material flows in modernisation: partial demolition and disposal, reuse and repair of the construction and new additions. With this information it is possible to improve the environmental performance of a retrofit project during the design process and to compare relevant data about its environmental performance⁵⁵.

The energy consumption is defined in the design proposal and simulated with the appropriate tools.

Existing building	Preservation of substance vs. functional upgrades
Existing constructions	Reuse and repair vs. disposal and renovation
New TES envelope	Optimal ratio of energy saving vs. material efficiency (thickness of insulation vs. costs)
	Design for Disassembly (DfD)
	Life Cycle Assessment (LCA)
	Insulation material (EoL)
	Surface cladding (EoL)
	Light-weight structural design
Documentation	Inventory and certification of renovation
Energy consumption	Adjustment in operation (see above)
Service and maintenance	Lifecycle costs for: cleaning and surface treatment (painting), ease of repair, modularity
Durability	Service life interval, adaptability and separation of layers
Documentation	Update handbook and inventory

⁵⁵ DIN EN ISO 14040 Environmental management - Life cycle assessment - Principles and framework.

After modernisation follows a phase of operation when energy consumption and durability become vital aspects. LCA has a reduced significance in this phase due to minimal material flows. However a significant influence can occur, if there is a poor durability or a short technical lifetime of single layers or an entire system. Conversely, life cycle costs (LCC) are more important in this phase and have to be examined in detail for more efficient solutions. Efficiency enhancements of maintenance, cleaning and repair of the new façades are main focuses in its service life.

Further examinations, data and detailed calculations will be done and published in the forthcoming research project "SmartTES" (2011-2013). For further information please visit the project website <http://www.smarttes.com>.



4. TES System

4. TES System

Basic TES EnergyFaçade element:

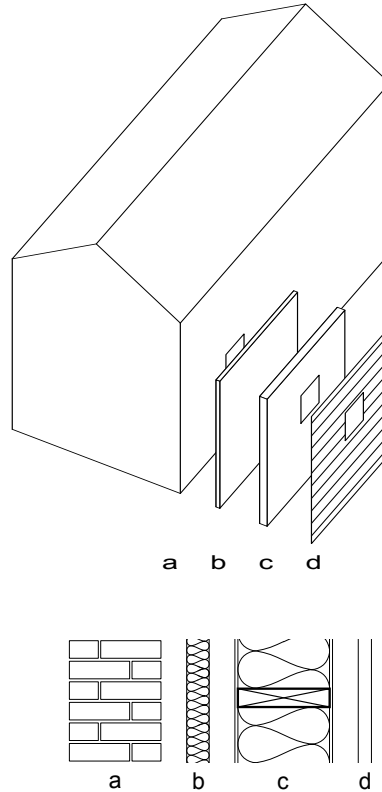

91. Basic TES application and system hierarchy with; a) existing structure, b) adaption layer, c) timber framework and insulation as main layer, d) cladding layer on the exterior side.

A TES element, similar to a timber frame construction consists of a load bearing supporting structure (e.g. construction timber, I beams etc.), an insulation infill and a protective cladding layer.

Looking at the different elements of the retrofitted building envelope, the three parts interact in different ways:

Existing structure, which is mainly load-bearing for the building and additional load-bearing for the secondary structure of TES

Adaption layer in between the existing construction and the core elements to level unevenness of the existing façade

TES element consists of self-supporting core elements

Requirements for energy efficient retrofitting with TES elements:

1. Improvement of the insulation capabilities of the façade by a reduction of its U-value.
2. Renewal of the windows with airtight and thermal resistant frames and better insulating glass.
3. Avoidance of constructional, material and geometric thermal bridges by improved constructions.
4. Avoidance of uncontrolled ventilation energy losses by an airtight building envelope.

Cladding or Outer Layer

A great variety of cladding materials can be fixed to the substructure of the load bearing timber frame element:

linear, e.g. battens, boards

panel, e.g. timber veneer or cement fibre board, glass etc.)



92. Variation of cladding materials in combination with a TES basic element.

Cladding system	Layers and Materials	Ventilated
Shingles, mineral basis	Battens, shingles non-combustible	yes
Shingles, wood	Battens, shingles wood	yes
Shuttering, timber	Battens, linear boards	yes
Panelling, timber	Battens, timber panels (combustible)	yes
Panelling, mineral basis	Battens, panels (non-combustible)	yes/no
Thermal insulation compound system	Approved system of panelling and rendering	no
Glazing systems	Approved system of glazing	yes/no
Sheet metal systems	Approved system of sheet metal	yes
Solar passive components	Approved system of passive solar façade (e.g. translucent heat insulation, Lucido®)	yes/no
Solar active components	Approved system of solar panelling	yes/no
Plastic façade systems	Approved systems of plastic façades	yes/no

8. Different possible claddings of a TES EnergyFaçade.

Of course there are requirements concerning protection on the weather side of façades from driving rain, moisture loads, sunlight, wind loads etc. according to national standards (e.g. DIN 4108-3).¹

The outer or cladding layer serves as moisture protection of the core of a TES element.

TES has many options of façade cladding with a broad range of surface appearances:

Rendered façade: mineral plaster on wood fibre board base EN 13499
Panelled façade: wood products (laminated massive wood boards), cement-bonded particle boards (EN 634-1), fibre cement boards (EN 12467)
Glass façade
Timber façade: sawn or planed timber (e.g. bevel siding) (e.g. DIN 18516-1 Außenwandbekleidungen, hinterlüftet - Teil 1: Anforderungen, DIN 68800-2 Holzschutz im Hochbau, DIN 1052)
Sheet metal façade: zinc-based material etc.
Ceramic or stone façades with lightweight compound cladding material
Plastic cladding (polycarbonate, polyethylene)

The selected products and systems have to fulfil the requirements of the manufacturer and the related standards and the common rules of construction. All systems and products, used for the cladding of a TES EnergyFaçade, must also be compatible with TES element itself.

Windows, structural glazing, solar active components (e.g. lucido, gap-solution), photo voltaic panels or solar thermal elements, which due to size and similar construction systems are compatible to the timber construction, can be integrated into the frame structure.

Applied joining details are proven in construction of new buildings and guarantee a proper functionality of the additional exterior envelope.

The existing structure and construction of a building determines the adaption of TES elements in order to secure fire safety, air tightness and sound proofing. To prevent uncontrollable convection and fire spreading, beside ventilation of façade a cavity free construction is a necessity.

4.1. TES Element

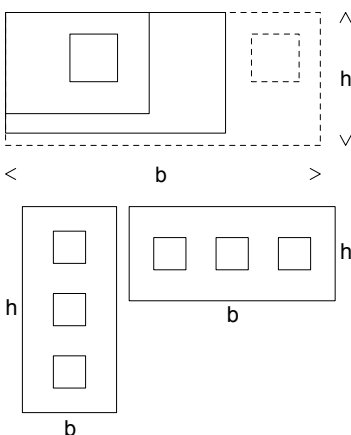

93. Variation in size and orientation of TES elements.

Façade elements are fabricated as identical or at least similar modules. It has to be noted, that similarity is today's concept of industrialised production. Prefabrication in timber construction is the manufacturing of individual modules in serial processes and can be described as mass-customisation.

Stand-alone, surface finished, timber-framed elements are attached to an existing, load-bearing structure. The concept of finishing defines itself related to an element and the combination of different constructional attributes. The element is open to the integration of different components with a wide variety of functional characteristics, e.g. HVAC subassemblies or solar active components.

The fabrication of modules further demands semi-manufactured products that have already passed a shape and attribute transforming process.

¹ DIN 4108-3 Thermal protection and energy economy in buildings - Part 3: Protection against moisture subject to climate conditions; Requirements and directions for design and construction.

Properties of TES elements:

Minimal structures (frame plus filling and panelling)
Rectangular and rigid in shape
Composed of different functional layers in one element
Assembled as single element (units) - joint with the neighbouring element
Window frames and glasses could be integrated off-site
HVAC, integrated as subassembly
Anchoring (fixation) usually prepared
Connection joints are sealed afterwards and side joints are closed during assembly
Alternative HVAC routing outside (inside special elements, constructed in bay style)
Autonomous fixation of each element (safety concept)

Basic TES element

The basic TES Element is self-supporting and consists of a structural core in analogy to a timber frame construction. The cavities are filled with insulation. The front (and optionally the back) is panelled with functional layers.

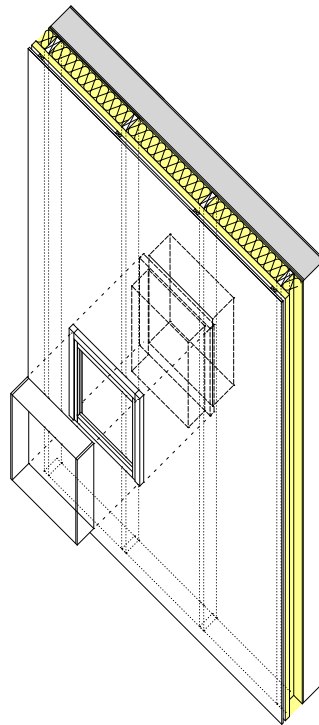

94. Basic TES element with a) insulation b) panelling and c) structure.

- a) Insulation: insulation material as filling of the cavities.
- b) Panelling: layer on front (required) and back (optional) of TES.
- c) Structure: self supporting, timber framed wall construction.

Structure

The framework of the core element is basically a timber frame construction of timber or timber based materials. The traditional post-and-beam can be enhanced by either with special studs designed for energy efficient wall compositions or other varieties such as crossed double-layered frameworks or comb structures. There is a certain variety of basic element structure that only has to carry its own weight and horizontal loads, i.e. wind loads.

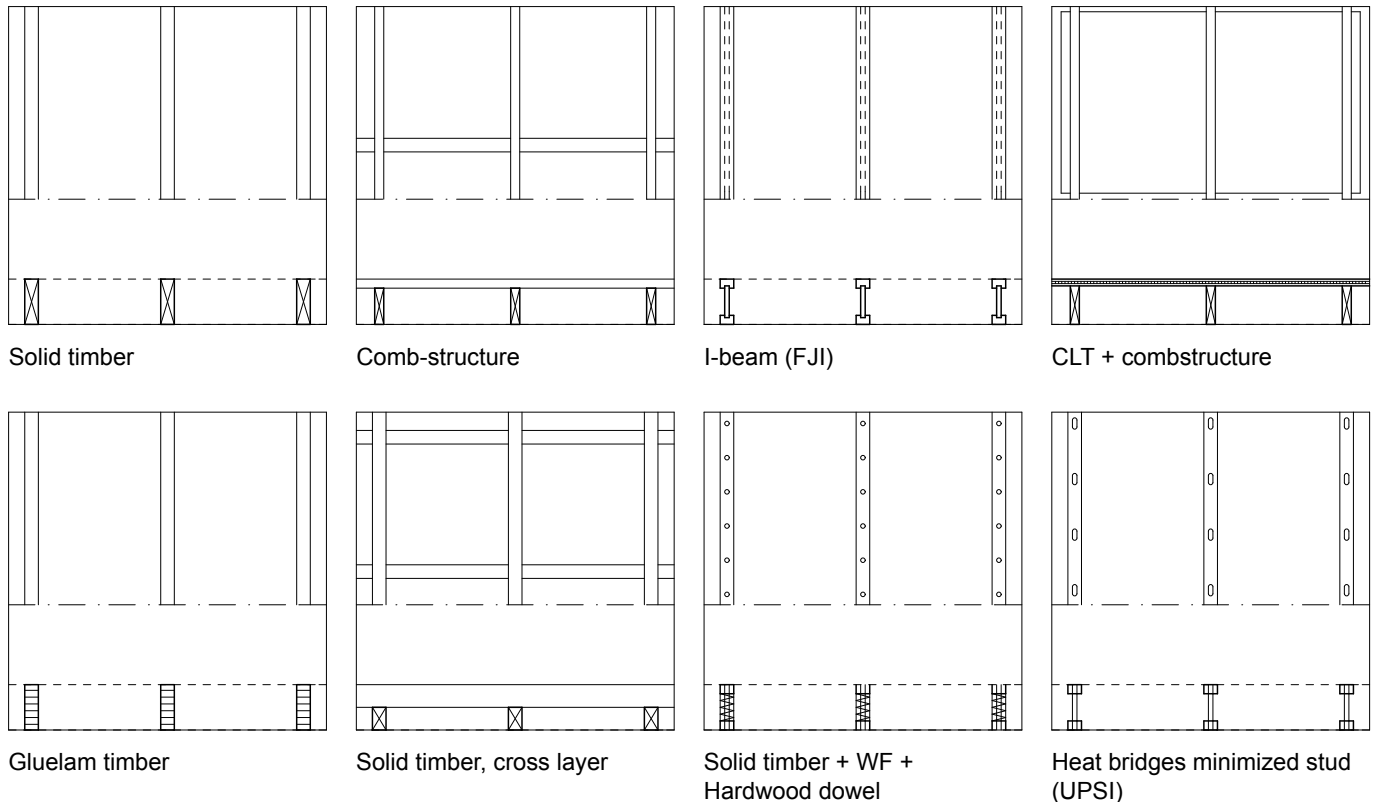

95. Different TES structure compositions based on the same principle of a framed wall element.

Insulation

The primary insulation layer is located within the framework. The dimension of the insulation is dependent on the requirements laid down in the required standards for thermal protection (e.g. EnEV) in their current version or the exceeding wishes of the client should these exceed them and in case of addition to existing exterior wall on the existing U-values.

A certain moisture absorption potential is a helpful material characteristic. If the insulation has absorption potential, the damp can be stored during the cold months without damaging the insulation and released again in the warm summer months. The potential to released moisture has to be higher than the amount that can be absorbed. A condition is the diffusion-open layering of TES and the basic rule is: the more vapour open the exterior layers the better. In most cases, especially mounting a TES element to an existing structure, an individual moisture simulation of the chosen structure is necessary. Dynamic simulation tools like WUFI® should be preferred, see example in chapter 4.3.2. The reaction to fire class has to be according to EN 13501-1 for more details see chapter 4.3.1. Required ecological indicators are:

Low heat conductivity together with a minimal gross weight (material reduction).

Low GWP (below +20 kg or negative CO₂eq.).

PE_{nr} << PE_{re} (energy release potential after use!)

The specifications are fulfilled by insulation materials based on renewable resources e.g. wood fibre or cellulose fibre products.

	Heat conductivity [mK/W]	Gross density [kg/m ³]	Material class DIN 4102 / EN 13501-1	GWP100* [kg CO ₂ eq.]	PE _{nr} ** [MJ]
Mineral wool ²	0,035	40	A1	46,4 ⁺	516 ⁺⁺
Glass wool ²	0,035	40	A1	45,2 ⁺	1010 ⁺⁺
Cellulose fibre ¹ (inj.)	0,035	55	B2	-50,1	387
Wood fibre ² (inj.)	0,04	45	B2 / E	3	0,9

¹ EPD from Österreichisches Institut für Baubiologie und Bauökologie (IBO)

² EPD from Institute of Construction and Environment e.V. (IBU)

* GWP = Global Warming Potential, functional unit m³

** PE_{nr} = Primary Energy not renewable, functional unit m³

⁺ GWP100 only for raw material and fabrication (cradle to gate)

⁺⁺ PE_{nr} only for raw material and fabrication (cradle to gate)

9. Adaption layer insulation materials.

Panelling Layer

Several requirements are met with functional timber panelling on a TES element: closure, stiffening, protection against mechanical impact, fire resistance and insulation. Inner panelling is not generally necessary, this depends on the level of prefabrication. Pre-filled elements need an enclosure.

The outer panelling is also necessary to make the TES element a warm wall construction which is wind tight and protected from the cold climate outside. Panelling have to fulfil general requirements as enclosure for the pre-filled and insulated elements protection against mechanical impact as well as building physics requirements:

Moisture and wind from outside and vapour tightness from the inside

Fire resistance necessary especially for buildings in class 4/5 (≥ 3 storeys)

Sound protection (mass and absorption).

	outer panelling	inner panelling	insulation / structure
existing skeleton structure			
a) closed cavity			
fire	x	x	x
moisture	o	x	
wind / convection	x	x	o
sound	x	x	x
existing monolithic wall construction			

b) open cavity			
fire	x	-	x
moisture / vapour	x	-	
wind / convection	x	-	o
sound	x	-	x
c) closed cavity			
fire	x	x	x
moisture / vapour	o	o	
wind / convection	x	-	o
sound	x	-	x

x = obligate, o = not necessary, (...) minimum requirements.

* buildings highest upper floor level in class 4 > 7 m; in class 5 > 13 m.

** convection inside the cavities in the insulation layer

*** when panelling is not necessary a membrane for weather protection has to be built in!

10. Requirements of panelling layers depending on its position.

4.1.1. Form and Function

The basic form and geometry of TES is defined by:

Size and module
Compositional structure of a warm wall construction + an additional façade system (warm or cold)
Variability of orientation of TES - horizontally or vertically

Size and Module

The first principle is derived from functional conditions and requirements defined by the appearance of the existing façade and the spaces behind. This dogma influences the design and the construction systems of façades especially of functionalist buildings of the 1950s and later. It is most obvious in the grid of the curtain wall façades of office buildings, spans of elements and sizes of modules.

Flexibility of floor plan in dwellings past, current and future dwellings, related to façade openings
Requirements for future façades - higher flexibility. Existing structure have to allow flexibility!

In principal, TES elements can be adapted to any grid. The timber frame system has the flexibility to meet almost every demand of existing structures and dimensions of housing or office buildings.

The element dimension depends on different renovation object parameters such as functional distribution, construction grids (axis, floor heights, binding joist, ring beam). Additionally there are restrictions caused by machinery and transport restrictions (in most cases < 13 x 3,8 m).



96. Elements for Realschule Buchloe.

A unique and important influencing prefabrication parameter to the form factor is the question of weight: The requirements for handling and mounting on site deal with the weight. High proportions of glazed areas combined with high thermal transmission standards such as triple-glazing and high insulation thickness result in relatively high module weights. This could be observed well at one of the monitored projects, the Realschule in Buchloe. All the above-mentioned parameters combine to create a high element weight of over 2.5 tons for a 8 x 3,7 m element.

The form factor is additionally influenced by the location of lifting appliances and the topography, the situation (courtyards, accesses, storage location), scaffoldings, manlift equipment and the spatial situation (roof eaves, terraces, different roof heights).

Compositional Structure

The second criteria is based on the rules of constructions and building physics of façade cross-sections. TES EnergyFaçade consists of at least two layers. Both layers are independent from each other from a structural, fire safety and modular point of view. A rear, invisible, warm wall section and a front, visible, cold or warm surface layer. The rear core is the structural part of the solution. It provides the anchoring, structural and insulation properties. The outer layer is responsible for moisture control and climate protection as well as the visual appearance.

Orientation

The direction of the basic TES element can be horizontal, vertical or even a space module:

HORIZONTAL

Mounting of storey high prefabricated elements in horizontal direction

Load supports storey wise or at base

+ Elements are delivered in mounting direction

+ Load support at base, reduction of forces applied to existing structure

VERTICAL

Elements fit to building height

Load support at base

- Elements have to be tilted from transport to mounting

+ Load support at base, no additional forces applied to existing structure

EXTENSION

The new building envelope forms an extension, existing space is integrated as interior (e.g. Balcony, Loggia) or space modules are extending the existing structure.

+ Conformable integration of glazing

+ Extension and upgrading of building envelope in a coherent building system

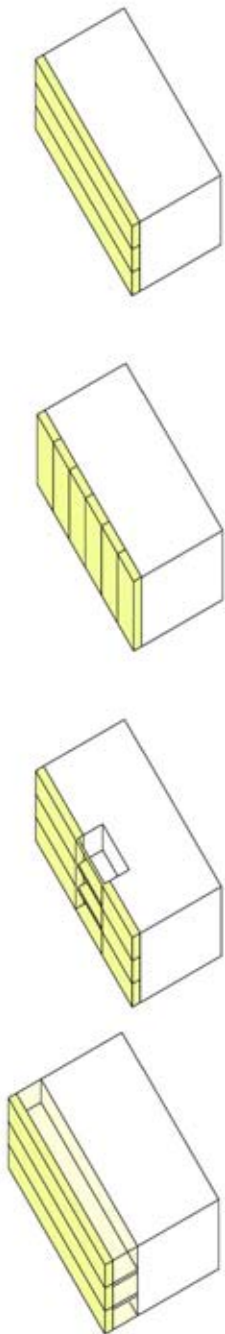

97. Horizontal and vertical division - spatial enclosure and extension.

Division Parameters for Elements

Parameters and Limitations:

basic: maximum element size (limits transport, lifting and assembly)

horizontal:

Storey height (support floor to floor)
Structure and building method (columns and crosswalls)
Functional (residential or class units, office space (departments) -> less flexible)
Fire compartmentation

vertical:

Structure and building method (support, columns and crosswalls, poor ceiling construction)
Roof extension (possibility for new load bearing structure, load-bearing core structure)
Building height (loads divided between lower / upper part)

mixture:

geometric solution (corners and edges)
technical requirements (HVAC)
functional (staircases)
joints of elements

Envelope Parameters

Overall wall / window factor (ratio wall / glass)
Element wall / window factor
Form-factor or compactness of the whole building - A/A or A/V ratio
Outline of façade defined by the factor front surface area / elevation area (to determine loggias, offsets, terraces etc.)

These parameters give clues on the energy efficiency as well as the resource efficiency of the modernisation project. They can be used to force measures towards higher compactness or reduction of heat bridges. Finally they can induce the inclusion of compensation measurements by appropriate building services.

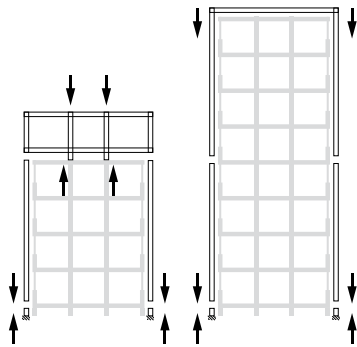

98. Self-supporting structure with own foundation and roof extension (left), partly suspended structure (right).

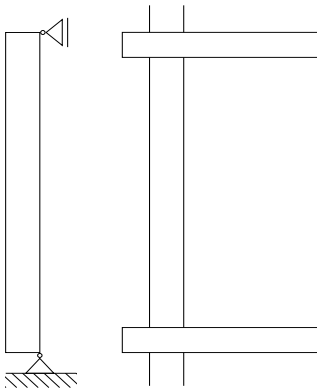

99. Ceiling slabs able to take loads in each storey.

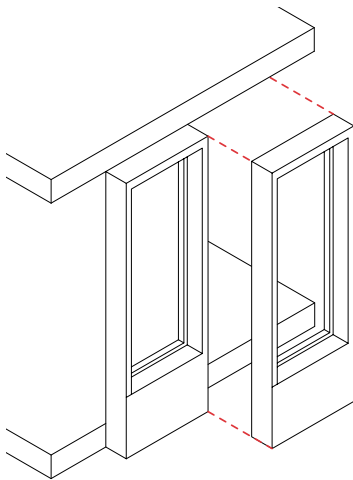

100. Basics concept of an element-façade

4.1.2. Adaption Layer

The cavity between the existing wall and the TES element needs to be filled to meet the requirements regarding fire safety and building physics. Any unevenness of the façade can be levelled using insulation. The choice of insulation material depends on fire safety requirements and building regulations. With proper encapsulation and using non-combustible construction materials around the edges of openings, organic insulation of material classification C-s3,d2 (E-d2) (i.e. DIN: B1 (B2)) may be used.

Filling variation

before assembly

Fixation of insulation layer on the back of the element or the surface of the existing wall

- Compression force needed
- Definition of material thickness depending on level of unevenness

after assembly

Injection of insulation

- + Simple levelling of unevenness
- Definition of width of cavity and openings

11. Insulation of the cavities can follow two different time schedules.



101. Fixation of adaption layer on the existing wall. Depicted here is a Heraklith surface, Real-schule Buchloe



102. Element joint at sill

TES injection test for small cavities < 6 cm

Participation:

TU München, Fachgebiet Holzbau
Dipl. Ing. Frank Lattke
- Documentation

Gumpp & Maier GmbH, Carpenter
Dipl. Ing. Alexander Gumpp
- Construction of the mock-up

ISOCELL GmbH, Insulation
Robert Mayer, Gerd Kaupp
- Injection of insulation material

The purpose of the test is to prove the practicability of injecting cellulose fibre insulation with a thin hose or lance into the cavity between a TES element and the existing wall. The test was performed on Monday, 20th April 2009 using a mock up model to simulate the cavity between an existing brick wall and a possible timber frame TES element.

The prefabricated elements with an inner cladding were placed on a mounted sill beam on the bottom and fixed at ceiling height and at the top. The gaps at the edges of the elements and the window openings were sealed, using a cellulose fibre matt (Isocell product: *Feeling Wood*). For evaluation of the filling procedure, a slab of double glazing was integrated into the small element.

Test arrangement

Location: Brunnenweg 1, 89278 Nersingen-Unterfahlheim, Germany

Applied material:

ISOCELL - Cellulose fibre

Fire safety and fungicide:

Boric acid and Bor Pentahydrat or
Ammoniumphosphat

Thermal conductivity:

0,037 W/mK

Bulk density:

38 - 65 kg/m³

Material class:

B – s2,d0 (EN 13501-1)

SLS 20 F - Foam glass granulate

Graining:

0-2 mm

Bulk density:

18-30 g/l

Thermal conductivity:

0,035 W/mK

Material class:

A1 (DIN 4102)

ISOCELL, FEELING WOOD - Cellulose insulation mat

Thermal conductivity:

0,04 W/mK

Material classification:

B2 (DIN 4102) / E

Density:

35-45 kg/m³

Mat size:

62,5 / 100 cm



103. Overview entire test assembly. Left a two storey and right a small sized, single storey element.



Conditions:

The wall surface of the existing building was not level and therefore the width within the cavity varied from 2-6 cm.

In some areas the cavity behind the glass slab measured less than 2 cm.

104. Element edges and their sealing.

Element 1:

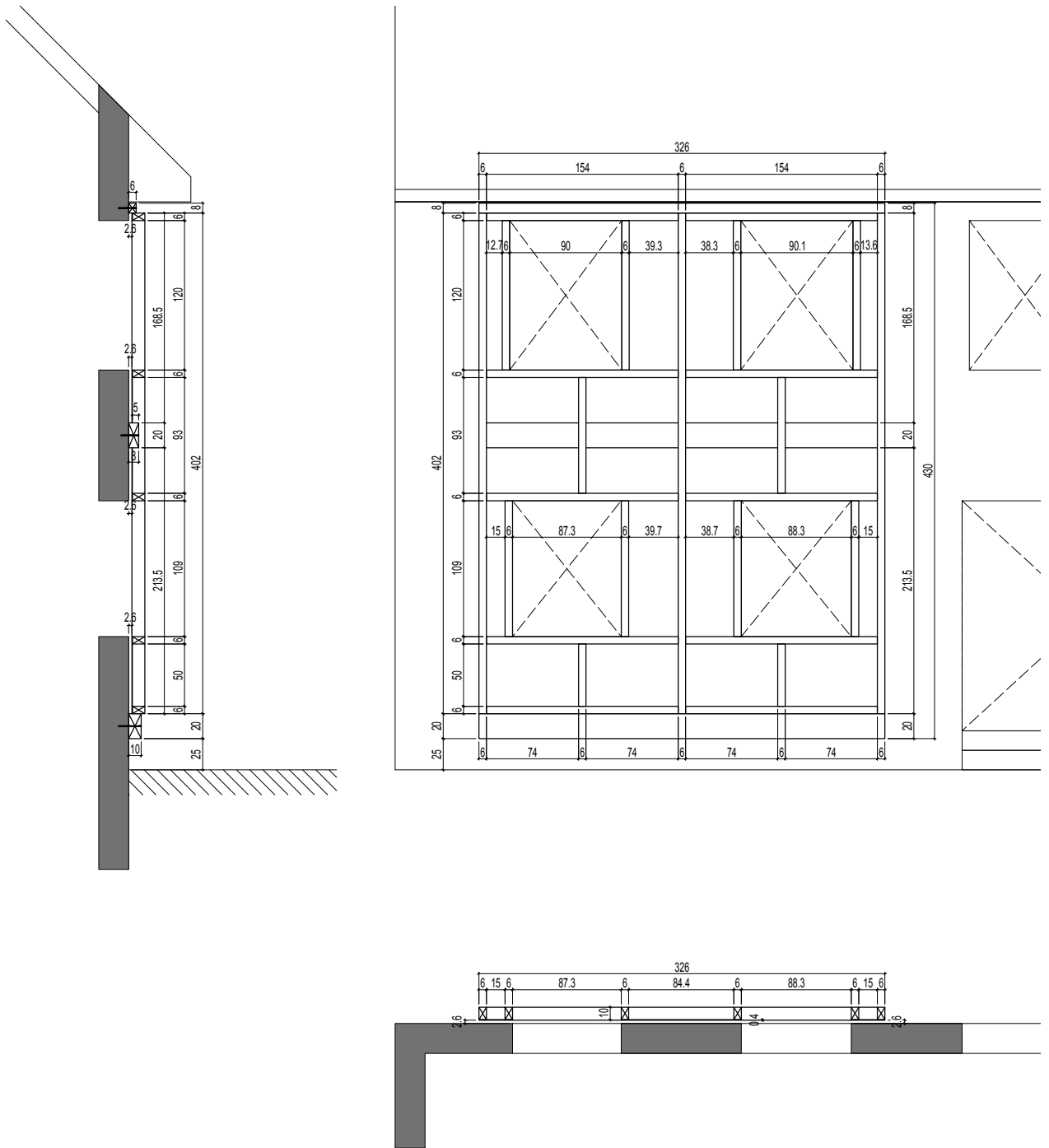

105. Drawing of the two storey element.

Injection

Construction element 1, left:

- Cavity 20 -30 mm
- Wood hard fibreboard 4,0 mm
- Timber frame 6/10

Element 2:

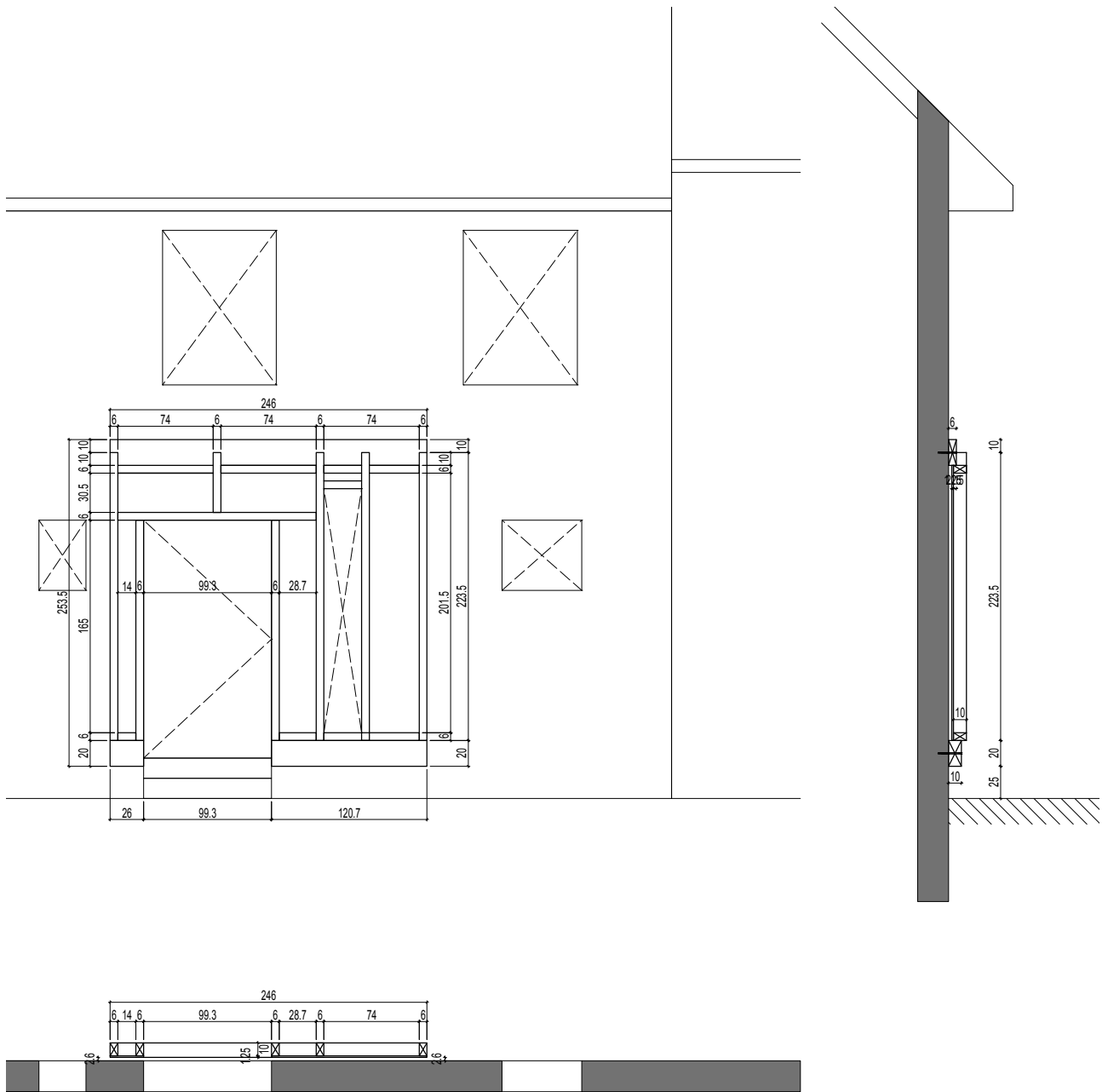

106. Drawing of small element.

Injection →

Construction element 2, right:

- Cavity 20 - 30 mm
- Fermacell 12,5 mm
- Timber frame 6/10
- Double glazing as control opening

Gap on window reveal:

Since the cellulose fibre matt is compressible, the unevenness of the wall edges was easy to compensate.



107. Window sill and reveal with sealing.



108. Insulation perforated by hose

Equipment used:



109. Trailer based standard ISOBLow station.



110. Filling procedure

Testing procedure and conclusion:

The cavity of element 1 (two storey element) was even filled using a 28 mm hose with a length of app. 10 metres. Through the gap of the windows and the sides of the testing element every space could be reached and filled.

The grade of density of the filled in insulation was evaluated by drilling a hole on the surface of the element. The cellulose fibre around the holes showed a sufficient density and the cavity was completely filled.



111. Hole for control of filling

Conclusion:

Width of cavity > 25 mm, better > 30 mm

Narrow gaps (< 10 mm) along the edges of the element were quickly closed by compacting insulation

Take precautionary measures against static discharges of hoses

Distribution from bottom to top

The injection openings need careful planning:

The hole in the sill beam, which should have been used to fill the element from the top was blocked by the Fermacell plate on the rear of the frame. Injection therefore was impossible.



112. Joints sealed with PU foam.



113. Drilled hole for filling hose.

SLS Granulate

The fine grained insulation material can easily be injected and flows into every cavity. However the element must be absolutely tight sealed as dust is produced that comes out of even the smallest gap. Appropriate safety measures have to be respected.



114. Dust emission through boreholes.



115. Control opening:
Cellulose fibre filling (bottom) and
SLS filling (top)

4.1.3. Window Integration

The integration of complete windows into a precise TES element in the factory process is the result of a thoroughly planned workflow from survey, construction planning, prefabrication to assembly. The following wall section gives an example of a TES element suitable for buildings up to 13,0 m (building class 4) with an encapsulated cavity behind the cladding a non-combustible insulation around the window opening and an adaption layer next to the existing wall

The existing window is replaced by a new window integrated into the TES element. The gap between the TES element and the wall is filled with on site blown in cellulose fibre. The side of the opening is covered with a strip of mineral wool.

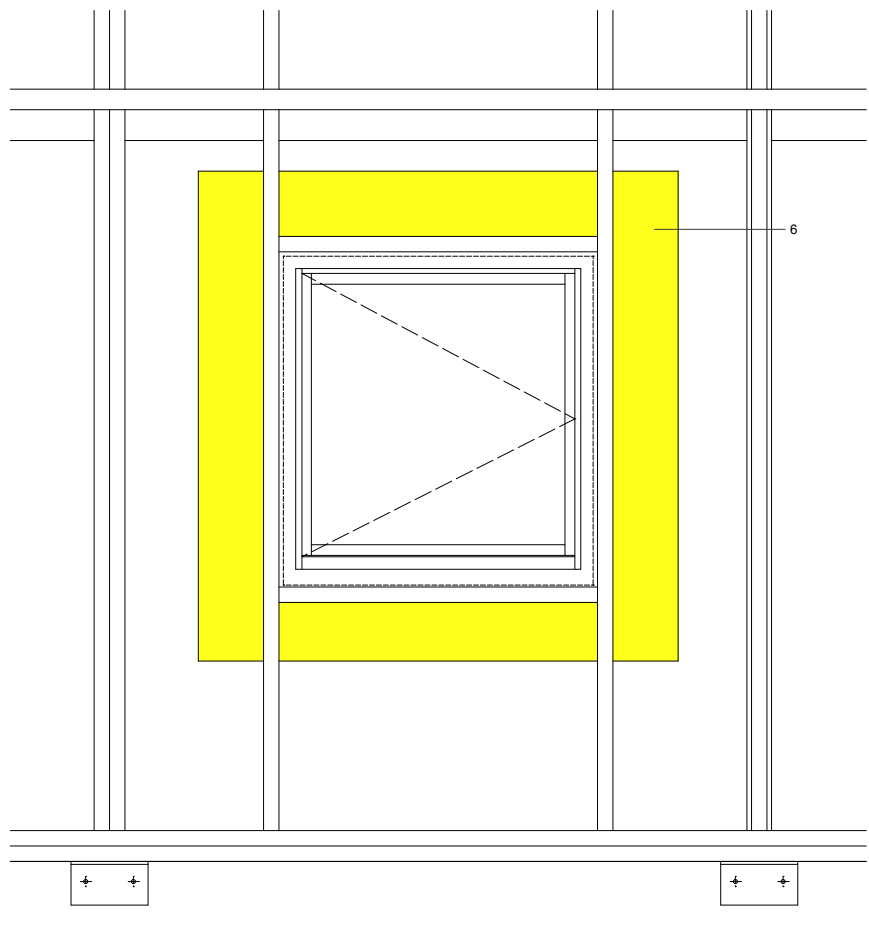
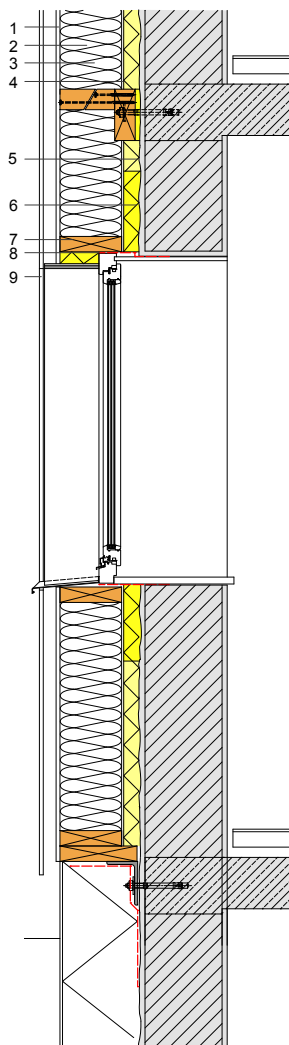

- 1 - Cement fibre board
- 2 - Cellulose fibre
- 3 - Stud
- 4 - OSB / Hardboard
- 5 - Adaption layer
- 6 - Mineral wool
- 7 - Lintel
- 8 - Sealant
- 9 - Cladding

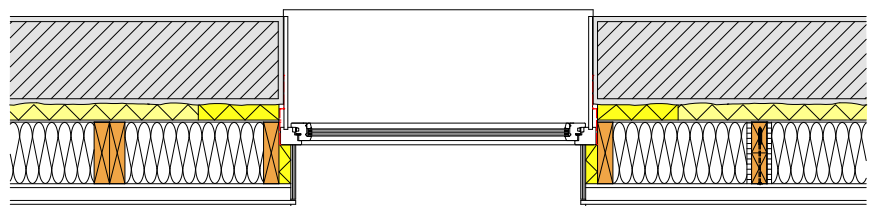

116. Elevation, vertical and horizontal section of a basic TES structure and layering.

Daylight

Basic Requirements

Required daylight factor D^2 in common rooms in dwellings has to be greater than 0,9 % on average and not lower than a minimum of 0,75 % according to e.g. DIN 5034-1.³ German building regulations require at least 1/8th of the floor area as window area due to the building regulations.⁴

Daylight Survey

Monolithic outer wall constructions have a rigid size of the openings. A modulation of the existing structure is not as simple, e.g. fixed lintel dimensions. Therefore an adoption of openings the new TES layer is required. The size of the existing window openings normally corresponds to the requirements of the building regulations. Their accurate dimensions are recorded during the survey.

Existing Conditions - Additional TES elements

The influence of direct light depends on the impact and progress of shadowing by neighbouring buildings and vegetation. Should this be the case a daylight and shadowing simulation tool will help to generate solutions for good visual properties of a room.

Daylight simulation with the DIALUX⁵ software tool shows that extending a wall thickness by 200 mm results in a difference of only 0.1 % daylight factor on a winter's day (21.12.) with diffuse daylight only. Similar results can be seen with direct daylight during a winter day. There is a small overall reduction of the average illuminance (E_m). The illuminance values very close to the window area are slightly higher with deepened reveals because of the higher amount of diffuse light reflected by their surface.

Normally new windows will not reduce the net opening of the glass. Highly insulated window frames have a narrow elevation compared to the standard window frame.

Alternatively bigger openings reduce the need for artificial lighting in rooms which also introduces an electricity saving potential. A detailed investigation in the size and modulation of the openings is recommended.

TES Daylight Solutions

The window reveals are excellent diffusers of daylight, reflecting it into the opening, and should therefore be painted in light colours. If they are dark, than light is absorbed and the daylight factor decreases substantially. This also applies to the interior side of the window frames.

An enlargement of the old openings is associated with lots of construction effort on-site. Nevertheless it provides a chance to cut larger and slanted openings which will increase the daylight factor. Also the spatial dimensions of the reveals are enlarged and give a positive effect on the architectural quality.

Window openings can also be modulated on the outside of new façade elements. They can have larger openings, slanted reveals, box type windows with a bigger box dimension than the existing opening, integration of light-directing systems etc.

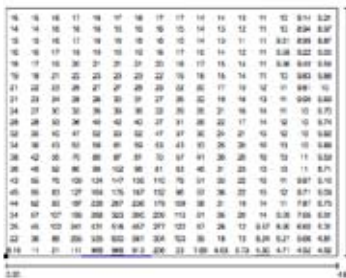

117. Distribution of illuminance values.



118. Rendered interior view of a room with one window and deep reveals.

2 $D = E_p / E_a * (100\%)$; E_p = illuminance on measured point on check level; E_a = simultaneous illuminance outdoors without obstruction and with clear sky.

3 DIN 5034-1 Daylight in interiors - Part 1: General requirements.

4 Musterbauordnung (MBO), (2002) German design building regulation.

5 <http://www.dial.de>, professional light planning software for artificial light & daylight

Window replacement

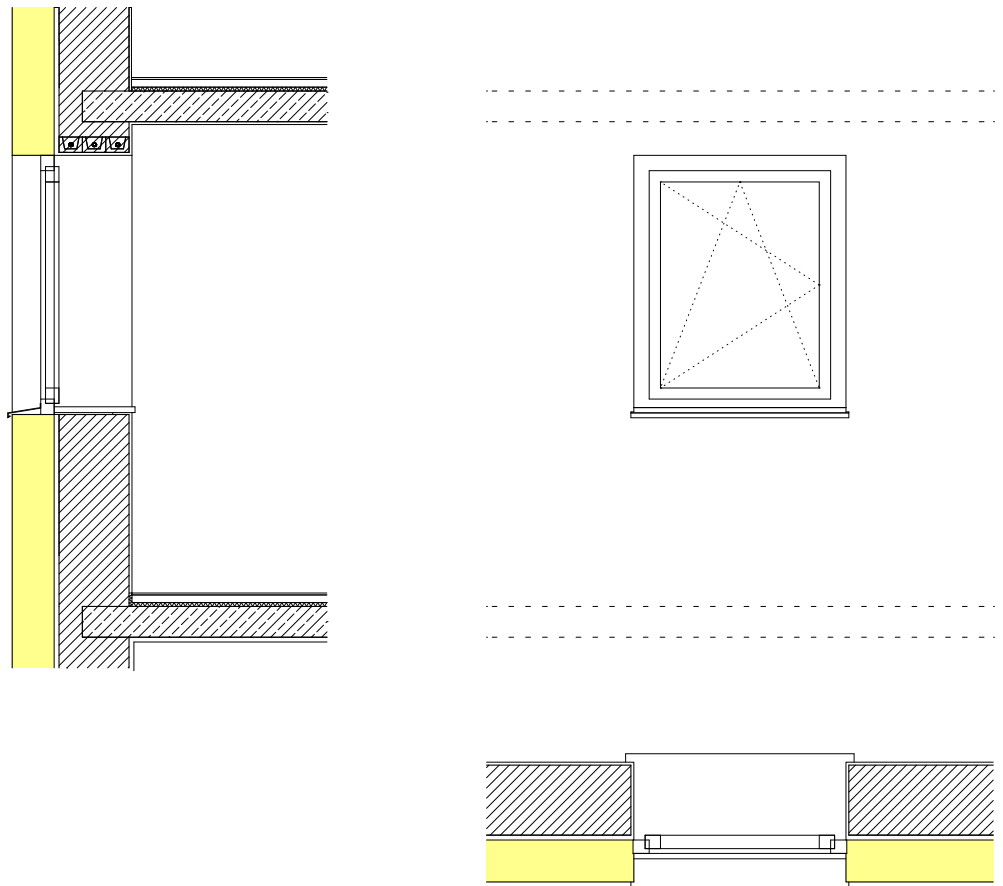

119. Window replacement in masonry wall construction. New window is fully integrated in insulation layer.

	Requirement	Consequence
Action	Replacement of the existing window, location in TES element	
Survey	Reveal and corners of opening	
Workflow	<ul style="list-style-type: none"> • Preparation • Mounting of TES element with integrated window • Removal of old window • Joining and sealing • Adaption of reveal 	- Removal of sill at survey
Intervention	Intervention concentrates on window opening and interior reveal	Deterioration of day light situation due to wider opening

12. Synopsis of requirements and consequences for window replacement.

Window addition

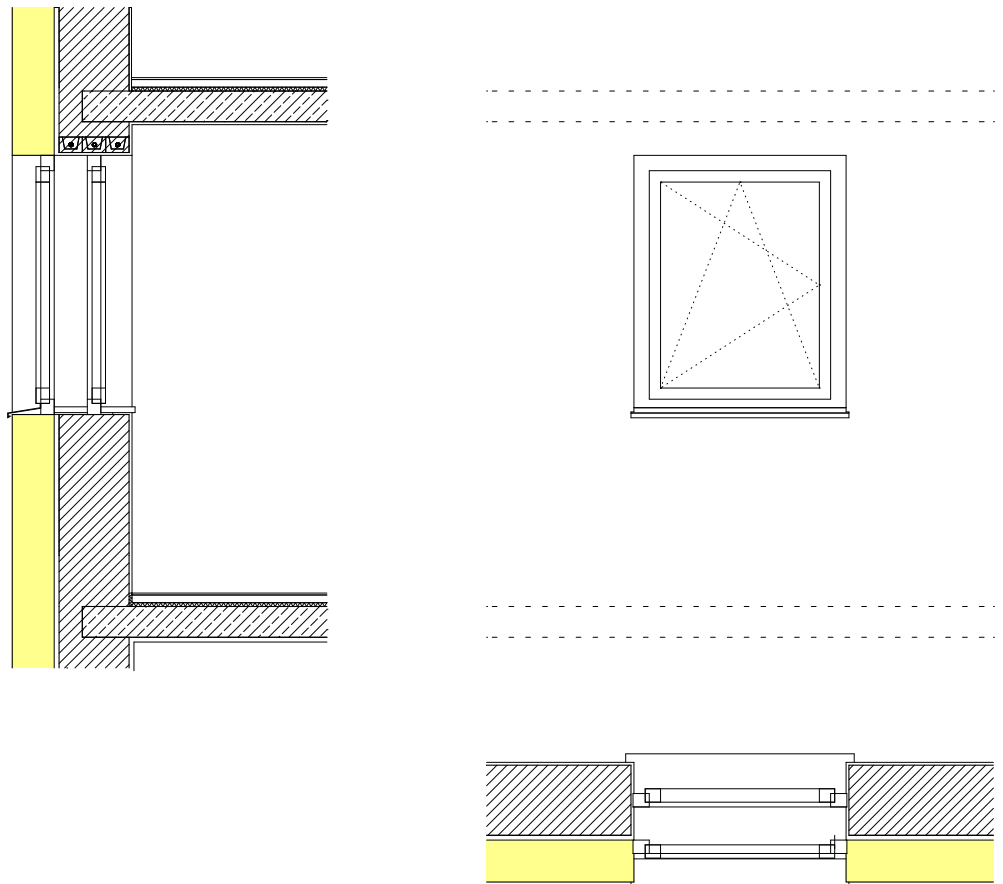

120. Conservation of existing window and an additional exterior window integrated in the insulation layer.

	Requirement	Consequence
Action	Preservation of the existing window, addition of a second window in TES element	
Survey	Existing window, reveal and corners of opening.	
Workflow	<ul style="list-style-type: none"> • Preparation • Mounting of TES element with integrated window • Adaption of old and new window • Joining and sealing • Adaption of reveal 	- Removal of sill at survey
Intervention	Intervention concentrates on window opening and interior reveal	Deterioration of day light situation due to wider opening. Opening of new window to the outside

13. Synopsis of requirements and consequences for window addition.

Window enlargement

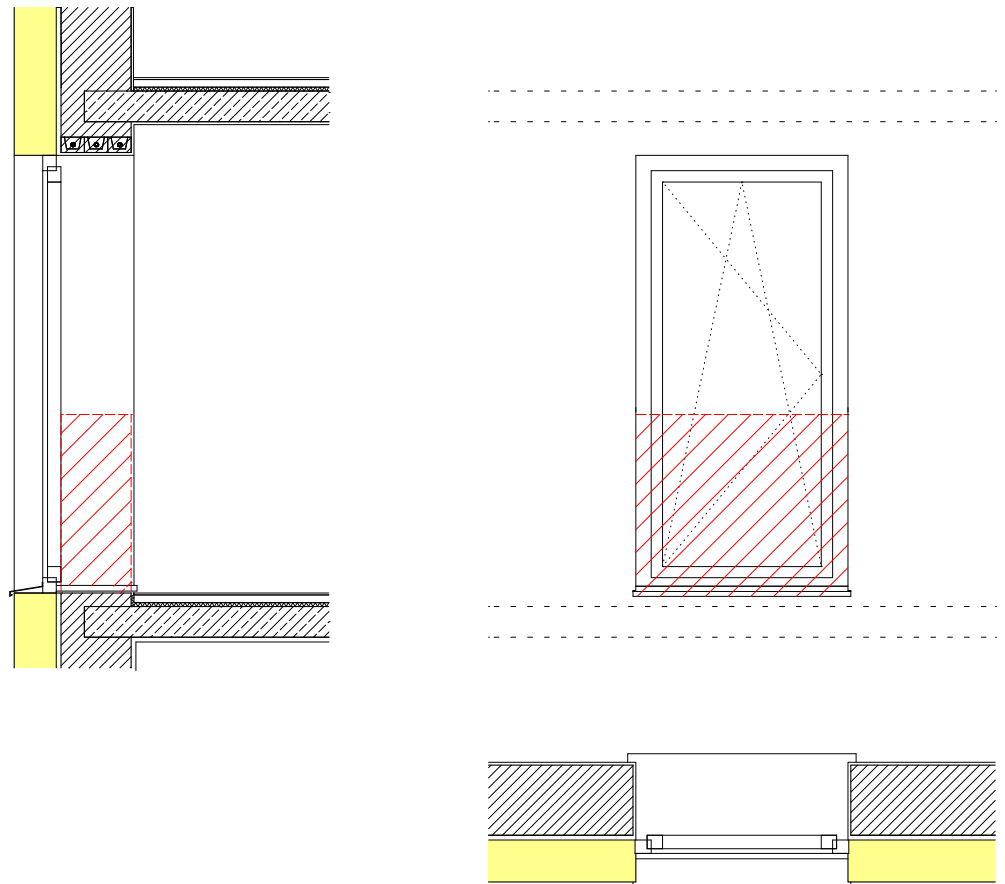

121. Enlargement of existing window geometry (french window).

	Requirement	Consequence
Action	Vertical enlargement of the existing opening, e.g. brick wall	
Survey	Top corners, definition of bottom edge	Effort to define exact opening in the existing status.
Workflow	<ul style="list-style-type: none"> • Preparation • Removal of existing window and brick sill • Mounting of TES element with integrated window • Joining and sealing • Adaption of reveal and floor covering 	- Removal of sill at survey
Intervention	Intervention around the window opening	Disturbance through noise and dirt

14. Synopsis of requirements and consequences for window enlargement.

Demands of properties of the joint window frame-reveal

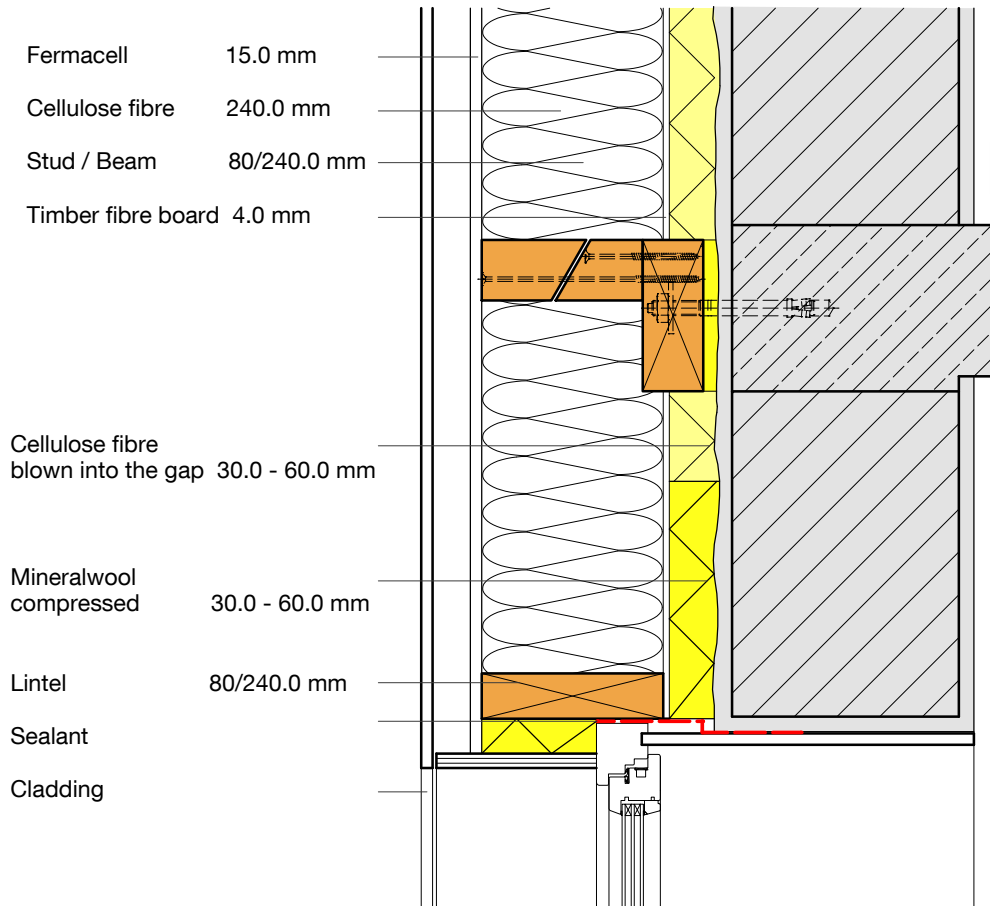

122. Vertical section window lintel with air-tight sealing of the gap (adaption layer).



123. Airtight joint at window reveal with a double layer gypsum fibre board



Properties	Demands
Air-tight on the inside:	Sealant or tape connecting window frame and wall
Vapour tight	Quality of the tape or sealant
Wind-tight on the outside	Fermacell on the surface Insulation and cladding of the exterior window embrasure

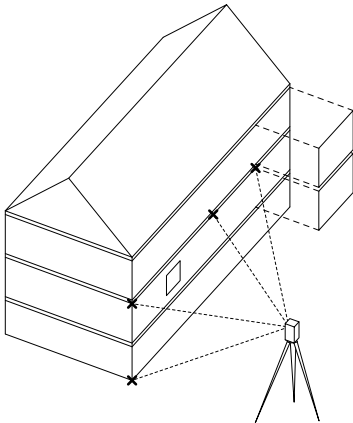

124. Precise adjustment of edge beam for fixation of elements.

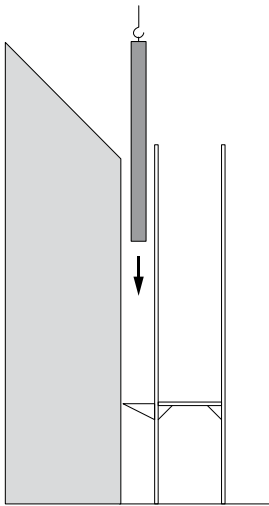

125. Distance of scaffolding for mounting purpose.

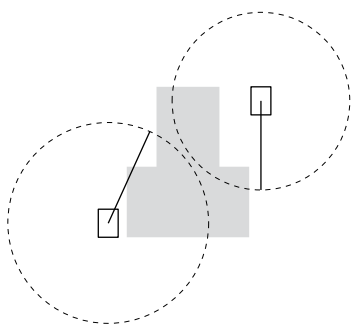

126. Operating range of crane and other lifting devices.

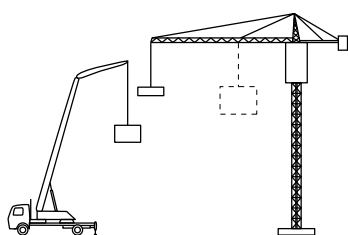

127. Different lifting equipment with mobile crane etc.

4.2. Assembly and Fixation

4.2.1. Assembly

Handling, mounting, and fixation of TES elements are the central aspects of the realisation on-site. Time and practicability factors are central to achieve economic advantages and positive social impact.

Potential of the TES EnergyFaçade as a load bearing element:

- Floor space enlargement
- Extension of the envelope (wintergarden, spatial layer)
- Addition to existing building or a roof-top extension.

The fixation is divided into several process steps.

- The foundation bracket or support beam is adjusted with the help of digital measuring methods.
- The large format elements are stapled on this linear support with higher precision and speed instead of an individual single point fixation and adjustment.

Roofing extensions on eaves and verges:

- Renew and extend due to higher wall thickness (insulation)
- Complete cut off eaves and install new ones later in process
- Preserve them and mount TES below (special lifting equipment)

Scaffolding:

- No scaffolding
- Façade scaffolding with distance to façade (ca. 500-600 mm)
- Working platforms of different type

Lifting devices:

- Truck crane (small)
- Mobile crane (element weight and jib working radius)
- Site crane (weight and working radius)
- Others (telescope fork-lifter, special devices -> like O.LUX "cross bar")

128. Lifting solution for façade elements beneath roof overhang or structured façades, balconies etc. Developed by O.LUX, Georgensgmünd



4.2.2. Load Bearing

Basic requirements

TES modules are self-supporting façade elements of sizes maximum 3,8x12 m mounted to an existing building structure with an uneven surface and very often without optimal structural strength.

In modernisation projects functional arrangement or architectural design are sometimes changed. This requires the examination of the entire building structure. Interventions in the existing structure will remove parts of the structure or require new reinforcing parts. This is often necessary, when roof-top extensions are planned. Therefore the entire construction has to be checked and adapted to the new situation.

Requirements for the load bearing support and the fixation of TES façade elements:

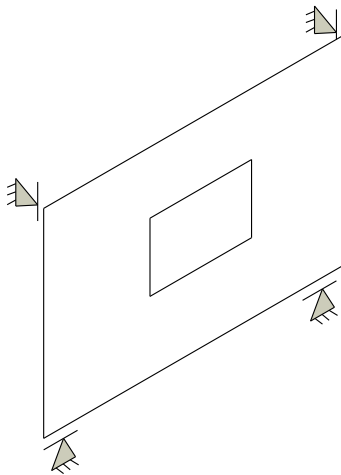

129. Supports of TES element.

Vertical - from own permanent weight (+ snow and ice)
Horizontal - from wind pressure and suction, parallel and orthogonal to façade plane
Horizontal and vertical - from earthquake, parallel and orthogonal to façade plane
Horizontal and vertical - forces of the modules due to their thermal and hygroscopic behaviour.
Loads during the assembly process and different stages of completion.

All new load bearing structures have to fulfil the requirements according to the building code, common technical rules, standards and guidelines.

Typology of mounting

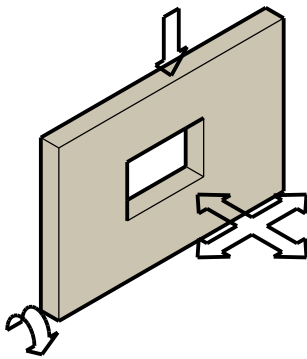

130. Loads on TES element.

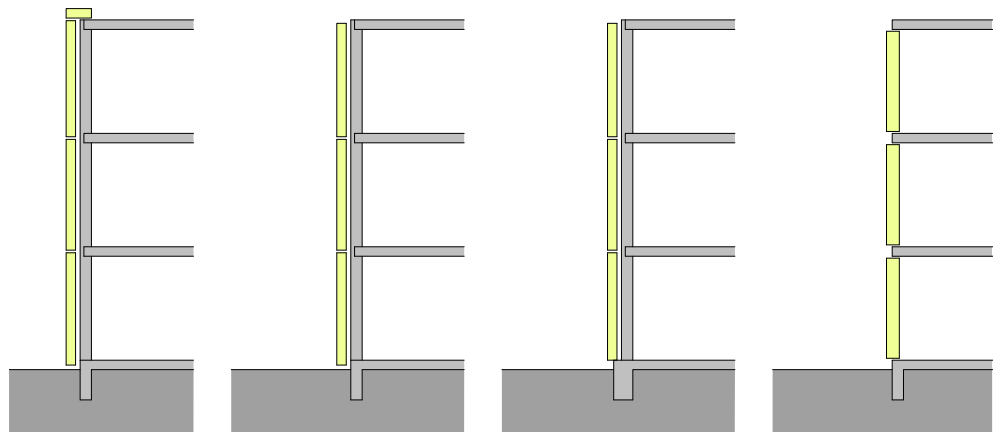

131. Typology of mounting elements a) hanging, b) storey wise mounted, c) standing, d) storey wise standing.

a hanging: elements are hung down from the construction. Vertical loads are collected on top of the building, going down through the existing structure, which has to be firm enough.

b storey wise mounted: elements are mounted at the head of the ceiling or into the wall.

c standing: the vertical load of the elements is lead into the existing construction or a separate foundation at the bottom of the building.

d storey wise standing: the elements stand storey wise on the ceiling. (e.g. Student apartments Neue Burse, Wuppertal)

Load Bearing Survey

The conditions of the existing building have to be properly evaluated. Analysis and evaluation have to be done thoroughly on the basis of the complete geometric survey and a condition record of the structural system. In a second step all joints and properties of the existing situation have to be examined. The experience from pilot projects have shown benefits for cost and risk minimisation due to a detailed planning based on a complete survey.

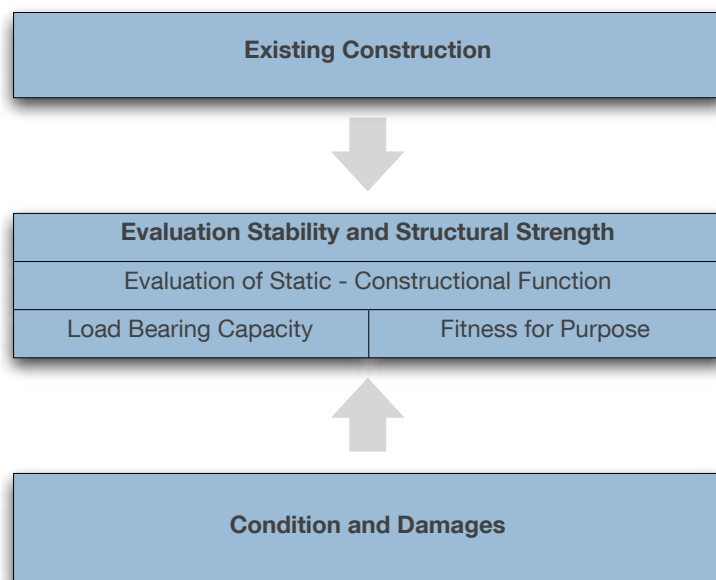

132. Load bearing survey process.

The following survey and condition records are necessary:

Detailed geometric information (e.g. floor slab joint)

Overall geometric analysis (unevenness and adaption layer thickness).

Condition of load bearing capacity and constructional function based on analysis and testing of the structure.

Information needed:

Position, spans and dimension of all load bearing parts (existing construction).

Materials (layers, compound)

Concrete compression strength (strength tests, often based on drill-cores)

Tension forces (tension testing of dowels)

Reinforcement positioning (thermal or radar tracking equipment).

Historic standards of the existing construction.



134. Pull test at an existing concrete wall.

The current state and condition, define the structural strength capability. Damages to the existing construction must be repaired to ensure its durability for further life cycles.

Existing conditions - Anamnesis

The obvious starting point is always the existing plan documents of the as-built situation as well as original structural calculations.

For detailed information on load bearing capacity an on-site survey, which investigates the structural system and its construction details is in any case necessary.

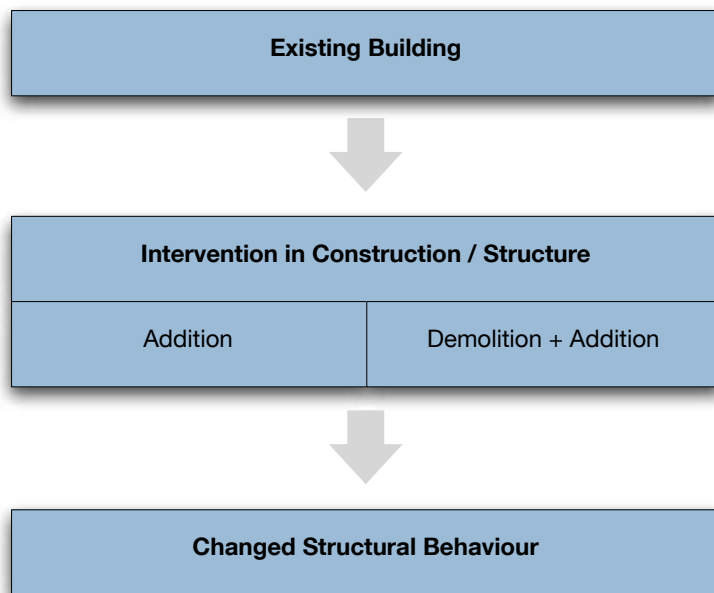

133. Existing condition analysis.

Various conditions will be found for the fixation of TES elements on buildings of the 1950s to 1980s. There is the difference between the monolithic and the core and shell building structural methods, e.g. concrete skeleton structures. The construction of the envelope also differs from punctuated façades to curtain wall façades. The construction types have several versions in hierarchy, composition and layering.

Skeleton constructions have advantages for the requirements of structural joints. Elements can be positioned on the outer edge of floor slabs. This load application point directly takes vertical loads. Therefore only a securing of the base is necessary in order to hold position.

External walls and columns normally have little capability to take higher point loads from single dowels. There are solutions which use continuous anchoring but this results in exceptionally high fixation effort on site. Nevertheless, there is the need to reduce and concentrate the fixation points close to the horizontal load bearing structures like floor slabs. These areas are ideal zones to take vertical and horizontal loads.

In additional there are now approved fixation systems for masonry work. The load bearing capacity of the dowels have to be proven in each particular case by mechanical pull tests on the building. Although the suppliers of dowel systems offer support for this kind of solution and the costs are minimal, they still have to be considered in the tender documents.



135. Adhesive anchors for concrete or masonry walls.

Floor structural systems of the 1950s are often concrete-block compound or brick-concrete compound systems with ring beams. These constructions have fewer fixation possibilities. In later decades virtually cast-in-place concrete floor slabs or prefabricated large scale concrete elements are common.

Various solutions for a load bearing foundation at the bottom of a TES element are possible, these have to be adjusted to the load bearing capacity of the existing structure. The constructive protection of the timber elements at the base section of the wall always has to be considered and detailed according to relevant standards.

136. L- bracket with a sill beam.
Exchange of brick layer in front of
the ceiling, grouting closer.

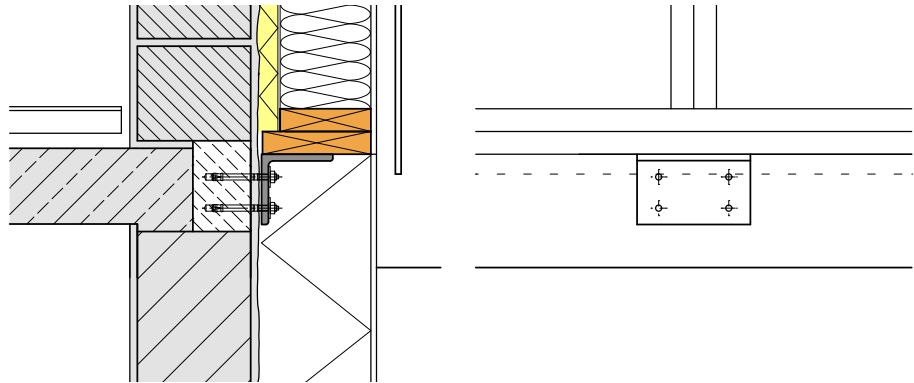

137. Cantilever beam
e.g. IPE rocker. Fixation under
basement ceiling, grouting closer

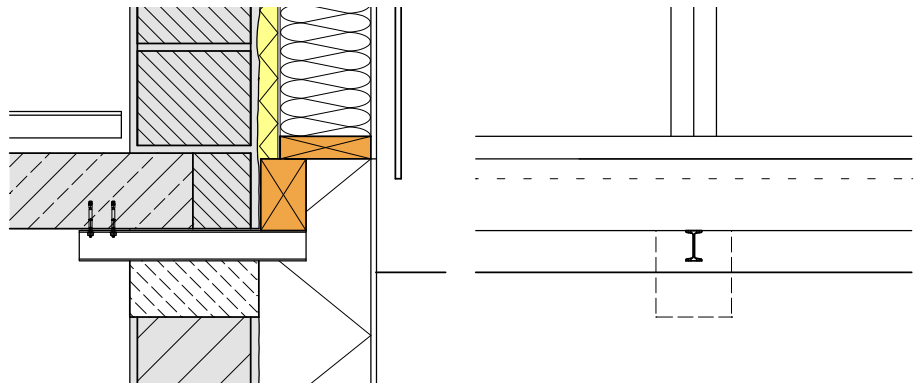

138. Foundation
Precast concrete component, frost
resistance founded, adaption layer
thermal insulation.

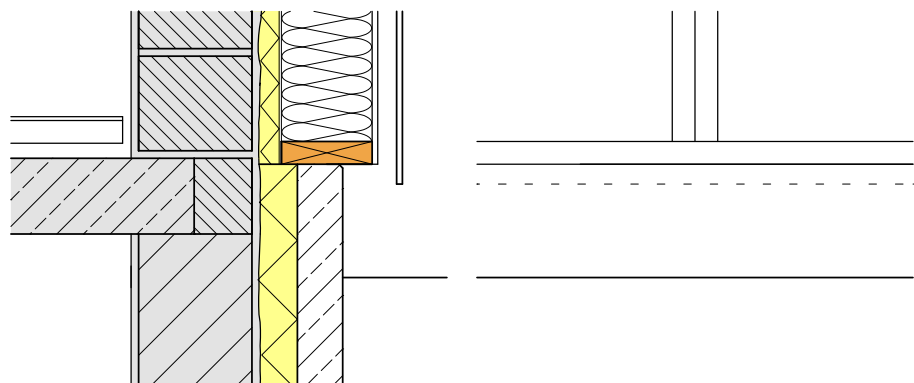

4.2.3. Element Façades Fixation Joints

Modular façade systems in generally consist of two basic parts, besides the element it is:

- the sub-construction or support
- connection or joint between elements

The design of supports in a façade modernisation project is an essential factor. It influences the whole construction as well as the fixation and mounting process. Sophisticated but simple to use solutions save material, time and ensure high quality. These are important economic aspects. TES façades are made from large modules (up to 12 m length and up to 3,8 m height, weighing up to 3 tons). Large modules are often positioned only from the front side with no access to the back. They should be adjusted and assembled as simply as possible. Single fixation points increase the complexity of assembly works. A linear fixation of an edge joist or a sill beam, common in timber construction works, offers the advantage of premounting elements easily and comfortably. This method is self adjusting horizontally, because the edge joist is already adjusted. A final adjustment in depth is necessary but simple. Modules can also be easily fine tuned on a sill using small blocks or timber strips.

Support and Fixation

Façade construction commonly uses the single point or the linear fixation of elements. The support system is either a sub-construction or direct fixing to the existing structure.

Punctiform fixation systems are: dowel systems, single brackets or special hinge systems, hooked into appropriate rail systems, e.g. agrafe systems. Custom made hinges or brackets are quite often used in façade mounting technology taking vertical and horizontal loads. They are suitable for TES elements as well, when there is the possibility to access the hinges from the back, e.g. in open skeleton structures.

Linear supports can be anchored and adjusted horizontally with high precision by the application of digital measuring methods. Afterwards the effort for the mounting and fixation of the elements is much lower than single point connections. The effort required for adjustment of large scale parts can be reduced when there is a premounted support structure.

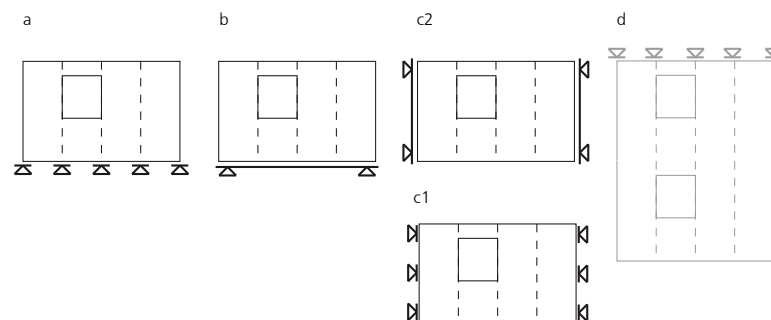

139. Fixation possibilities of TES modules a) punctiform support b) linear horizontal supp. c) linear vertical supp. d) hinge fixation

There is a wide range of possibilities and the ultimate choice as to which best solves all the requirements depends on the individual project.

Element connection

The joints of TES elements:

- a) Flush joint
- b) Rebate joint
- c) Tongue-in-groove joint

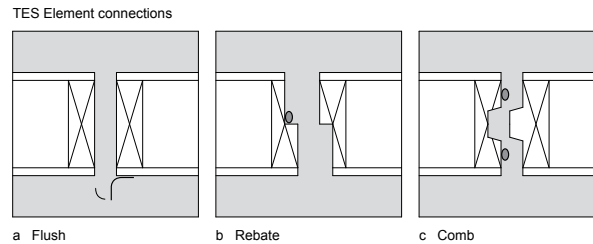

140. Different types of elements joints and sealing solutions.

There is always a possibility of a gap between element joints. Thus proper sealing for air and wind tightness, sound protection and especially for fire safety reasons is a requirement. Elastic sealings between joints are necessary to prevent sound and air diffusion. Fire safety should be addressed with the front panelling layer by rebate joints. The joint between the layers of two elements has to close the joint entirely. Another alternative is the filling of the gap by a strip of flexible mineral wool which is pressed against flat sides of timber studs on each element joint. The front side must in any case be sealed to ensure wind tightness.

Air	Sound	Fire and Smoke	Transport (Quality)
Elastic Sealant	dito	Casing	All varieties have be protected at least with a diffusion open membrane when there is no paneling layer (weather protection etc.).
Cast-in Sealant	Rebate	At least Cast-in	
Cast-in Sealant	Groove-and-Tongue	Sealant, depends on required fire resistance	
Tape Sealant	Mineral Wool	At least Tape	
	Mineral Wool	Sealant, depends on required fire resistance	

15. Sealing methods for different kinds of impact.

4.3. Building Physics

The main subject of concern lies in the existing building's hygrothermal (heat, air, moisture), acoustical and light-related properties, from the small scale building components to the entire building as one hull/envelope and its environment (climate, neighbouring buildings).

Its task is to fulfil the users demands for thermal, acoustic, safety and visual comfort and health in general.

All building components with possible hazards have to be investigated to ensure the high quality and the projected durability of a new TES EnergyFaçade.

4.3.1. Fire Safety of Façades

TES elements are defined as non-load bearing façade elements that are adapted to load-bearing, non-combustible structures. TES elements have to follow the requirements of non-load bearing external walls in general. The cladding or visible façade layer on top of the external wall element has to be classified according to the combustibility for the material and is a separate part of the non-load bearing façade element.

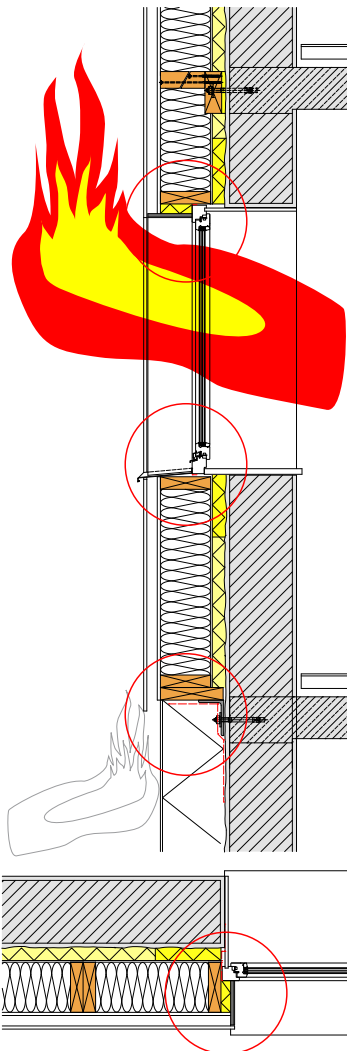

Basic Requirements

- the load-bearing constructions of the buildings shall keep their integrity in case of fire for the imposed minimum duration of time;
- the generation and spread of fire and smoke in the building shall be limited;
- the spread of the fire to neighbouring buildings shall be limited;
- the occupants in the building shall be able to leave the works or be rescued by other means;
- the safety of rescue teams in the building shall be taken into consideration.

Specification of fire safety objectives:

	Fire Safety Objectives	Specific Objectives
1	the generation and spread of fire and smoke in the works shall be limited;	autonomous escape of inhabitants (at least 10 minutes)
2	the spread of the fire to neighbouring construction works shall be limited;	remaining in secured areas until rescuing (at least 30 minutes)
3	the occupants in a construction works shall be rescued;	
4	the safety of rescue teams in building works shall be taken into consideration.	load-bearing capacity / structural safety of multi-storey buildings (at least 60 or 90 minutes)

16. General objectives and specific explanation.

141. Fire scenarios for TES façade and critical joints (red circles).

Definitions

General definition external walls: External walls ensure the enclosure of an interior space against the outer conditions (e.g. climate) or preserve the interior conditions from change (e.g. cooling). These constructional element normally exists in the selected type of buildings.

External walls may be load bearing, i.e. they support roof and / or floor structures and distribute the loads to the final foundation. Non-load bearing walls are only load bearing their self-weight and wind loads. TES elements are in principle non-load bearing.

TES EnergyFaçade consists of modular, large-format, exterior wall elements, that are applied in front of the existing load-bearing structure. They can be hung in front of an existing façade construction or can be used as partition wall to the existing load-bearing structure.

Overview of existing structures

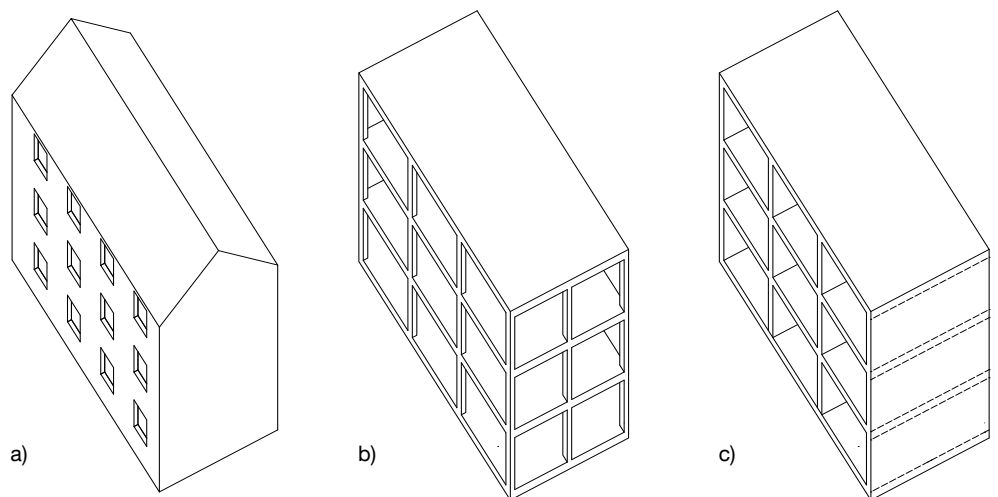

142. Building and façade structure of existing buildings a) punctuated monolithic wall structure b) skeleton structure c) crosswall structure.

Definition façades: These are the outer, visible, climate-exposed part of external walls (independent of material, dimension, fixation). They are only self-supporting and fulfil building physics or climate protection tasks.

Massive concrete or brick structures

Massive concrete or brick structures		
external wall load-bearing	external wall not load-bearing	
masonrywork or concrete walls, partitioning, with window openings	concrete columns and floor slabs (opt. dismantled) façade systems, massive building components, metalworks or timber constructions	concrete walls and floor slabs, partitioning (optional dismantled)
surface render, fully covered	surface cladding removed	

17. Typology of existing structures and external walls.

TES EnergyFaçade in combination with the building stock

In terms of fire safety it is necessary to realise TES as a composition of the three principal layers and the existing construction.

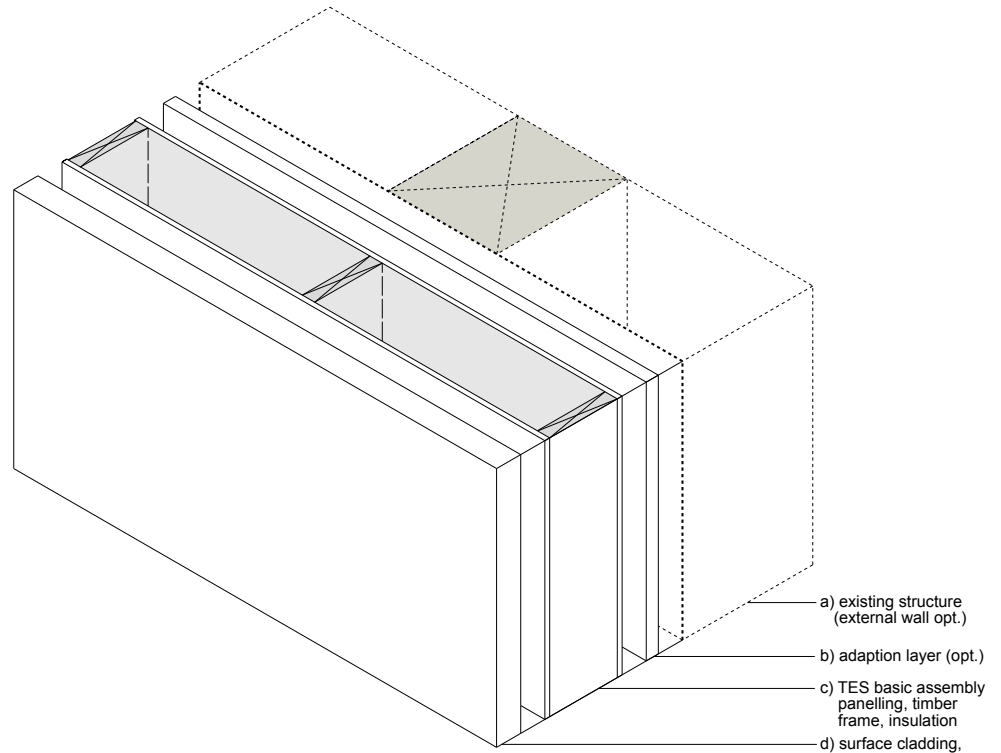

143. Layers of a basic TES façade.

a	existing construction / structure
b	adaption layer
c	TES basic element
d	surface cladding

Normally, the existing structure already fulfils the fire safety objectives. However the condition of the existing building has to be verified by a fire safety survey.

A TES EnergyFaçade element is a core assembly with two additional layers. On the outer side there is a surface cladding layer of various possible materials.

The TES façade layer has to fulfil the requirements of the relevant building classes. Up to building class 3 combustible materials are allowed, whereas in classes 4 / 5 or building ≥ 3 storeys, difficult combustible cladding and insulation material of at least class C- or B-s2,d0 is required. Timber or other combustible façade materials are possible but need special construction and additional approval.⁶ Where combustible material and ventilated gaps are used the cladding must have a storey wise separation either by suitable fire stops or with a floor wise horizontal separating construction.

The back of the TES element has an adaption layer which is responsible for leveling the unevenness of an existing construction (i.e. external wall or structural ele-

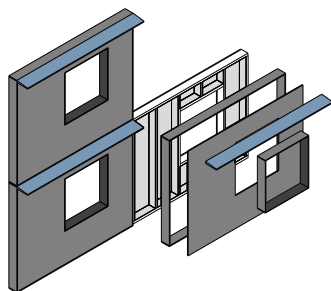

144. TES EnergyFaçade assembly with panelling and insulation for EI30 (grey). Horizontal fire stops (blue) for ventilated gaps of façade and floorwise separation of stacked windows.

⁶ Stein R., Winter S. (2010) Influence of Combustible Insulation Materials to the Fire Behaviour of Timber-Framed Buildings, in: Proceedings of World Conference of Timber Engineering, Riva del Garda.

ment). The adaption layer can be of combustible material if façade openings and each storey are encased or separated by non-combustible materials.

The self-supporting TES EnergyFaçade will be mounted in front of an existing, load-bearing structure. The TES EnergyFaçade has to be designed such that it retards the spread of fire along the façade or in the assembly.

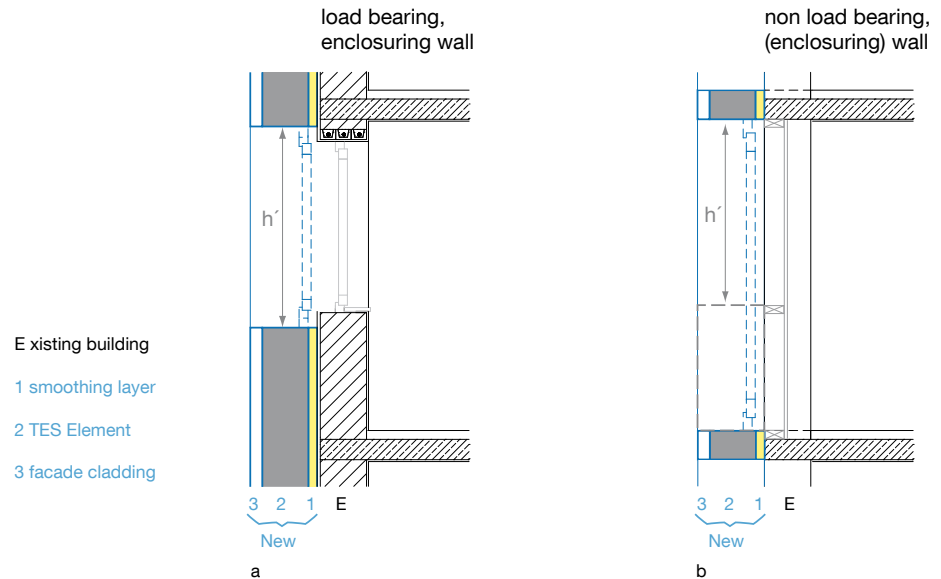

145. TES EnergyFaçade a) in front of load-bearing b) or non load-bearing external wall.

The TES EnergyFaçade can be mounted in front of an already existing external wall with a structural quality. Alternatively it can be placed in front of a partially demolished external wall or a skeleton or bookshelf structure without any external wall, in which case the TES EnergyFaçade constitutes the new external wall.

	Existing punctuated external wall	Skeleton or crosswall structures; dismantled external walls
Existing construction	external wall exists REI 60-90 (F 60-90)	no external wall R 60-90 (F 60-90)
Fixation	according to approval!	
Adaption layer	partitioned elements with floor wise fire stops	
TES EnergyFaçade assembly	EI 30 (W 30)	
Surface / cladding material	min. C-s3,d0 (B1)	

18. Existing buildings (≥ 3 storeys) with TES EnergyFaçade. German fire safety rules in brackets according to DIN 4102.

The interior of TES elements requires fire stops when the insulation material is combustible, to prevent a spread of fire within hidden, cladded parts of the facade construction. These stops can be integrated into the TES element in several ways, e.g. by horizontal barriers between each storey. The fire stops can be made of non-combustible material like mineral wool or gypsum fibreboard panels. A sill or head plate can fulfil the same function. In any case the functionality has to be proved by the application of fire safety engineering methods.

Prevention of spread of fire:

External walls and balconies shall be built so that a fire will not spread via them in a hazardous manner

The following must be taken into account in the design of external walls:

hazard of fire spread along the façade

hazard of fire spread within the external wall

hazard of fire spread through the joints of external walls and the fire-separating assemblies

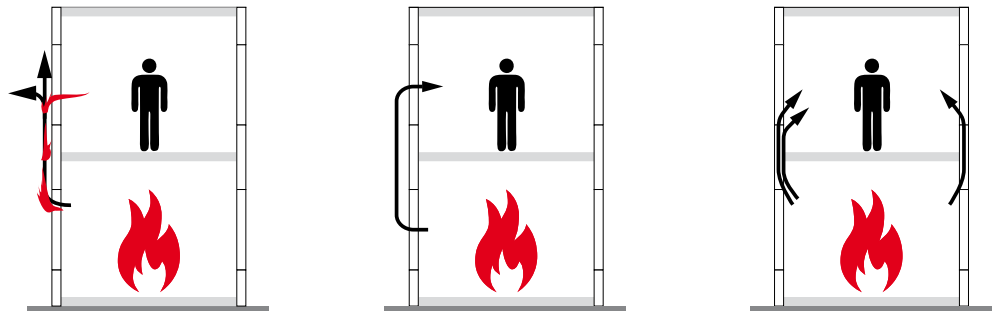

146. Spread of fire scenarios into upper storeys: over the façade layer (left), over the windows (middle), through the construction of the exterior walls (right).

TES solutions for the prevention of the spread of fire. The critical joints are the window zones, especially the window reveals and the lintels. There is the possibility to construct fire stops around the windows. Another measurement are horizontal fire stops that are separating the TES construction storey-wise. A third approach, useful for vertical TES elements are vertical fire stops and fire stops around the windows. Finally a combination of all three kinds of fire stops is built. The vertical stops in this solution may be necessary to separate functional units (e.g. apartment / office) in the building or separate fire compartments.

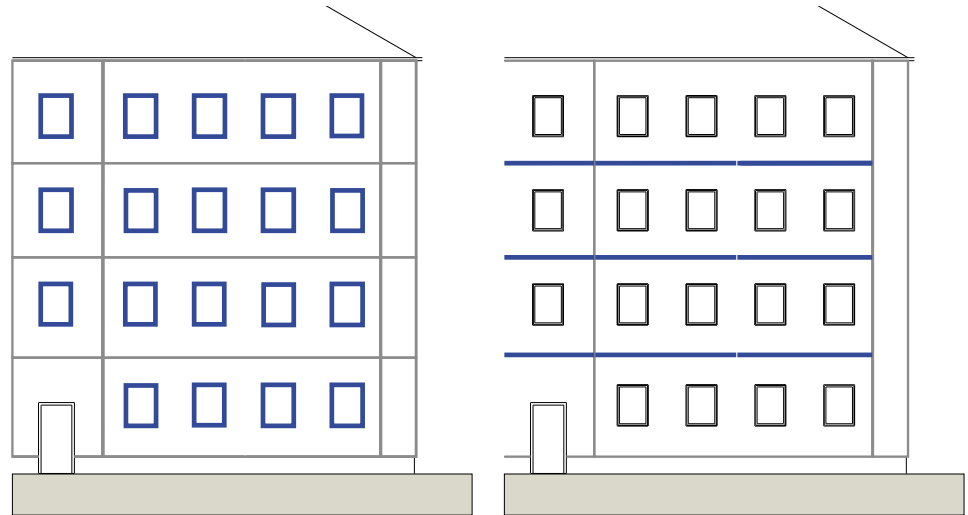

147. Partitioning with fire stops in order to prevent the spread of fire a) fire stops around windows b) horizontally storey-wise separation of the elements.

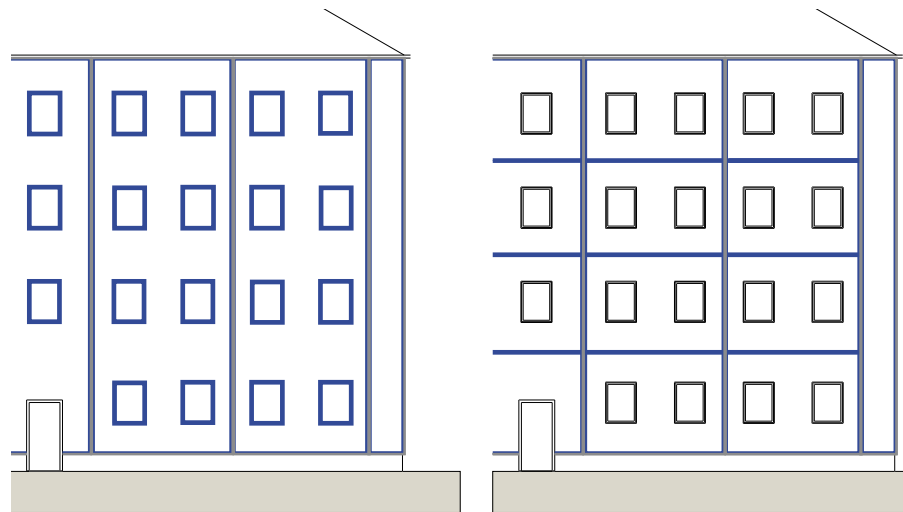

148. Partitioning with fire stops in order to prevent the spread of fire c) vertical and window fire stops together for vertical TES EnergyFaçade assembly, d) horizontal fire stops separate each storey and vertical fire stops between functional units.

European overview of fire safety requirements and testing of façades

Country	Facade fire requirements		Fire scenario	Test method	Exposure levels	Measurements	Façade test needed for wooden facades	Comments
	Upward flame spread	Falling parts						
Austria	x	x	Flames out of a window	ÖNORM B 3800-5	About 40 kW/m ² in 20 min	Damage, Temp.	4-5 storeys (ÖNORM B 3806)	Timber constructions ÖNORM B 2332
France	x	x	Flames out of a window	Arête 10/09/1970	15-75 kW/m ² in 15-20 min	Flame spread, Damage, Temp.	Depends on building type	Distance between buildings also to be respected
Germany	x	x	Façade corner with flames out of a window	DIN 4102-20 (draft)	20- 65 kW/m ² (350-400 kW) in 20 min	Flames, Glowing, Damage, Temp.	≥ 4 storeys	Evaluation criteria to be decided by DIBT
Sweden	x	x	Flames out of a window	SP Fire 105	15-75 kW/m ² in 15-20 min	Damage, Heat flux, Temp.	> 2 storeys	
Switzerland	x	x	Flames out of a window	Large scale test	600-800 kW in 15-20 min	Damage, Temp.	4-8 storeys	Reference no. 20 in [4.17]
UK	x	x	Flames out of a window	BS 8414	15-75 kW/m ² in 15-20 min	Damage, Heat flux, Temp.	> 2 storeys	

19. Synopsis of European facade fire requirements, by courtesy of the Woodwisdom-Net research project: Fire in Timber, 2008-2010.

Finnish Fire Safety Regulations for TES EnergyFaçade⁷

A TES EnergyFaçade can be designed and built without compromising fire safety

Building materials used in external walls in buildings of class P1 shall be mainly of at least class B-s1, d0. (finnish version)

Thermal insulation which is inferior to class B-s1, d0 shall be protected and positioned in such a manner that the spread of fire

into the insulation,

from one fire compartment to another

is prevented.

⁷ http://www.tesenergyfacade.com/downloads/tkk_tes_loppuraportti_2009.pdf, Finnish TES report, verified 8.11.2010.

For the insulation material in the cavities, the adaption layer and if necessary in the façade layer there are additional specifications.

If the insulations are of class A2, s1-d0, e.g. mineral wool, the façade fulfils the fire regulations

If the insulation is of inferior class than A2, s1-d0, e.g. wood-based products, the façade shall be designed so that fire spread is prevented

to the insulation

within the external wall

to joints of external walls and the fire-separating building elements

Appropriate design solutions can be derived using Fire Safety Engineering facilitated by modern fire simulation methods.

German Fire Safety Regulations for TES EnergyFaçade

TES elements applied to building classes 4 and 5, according to the German design building regulation (MBO), have to fulfil the requirements of structural elements. Therefore they are classified in the European context as EI30 (EN 13501) or in Germany as W30-B (DIN 4102). For buildings up to seven meters height to the top floor level (class 3), there are no restrictions for the external wall elements of the façade.⁸

German fire safety regulations on external walls according to the design building regulation:⁹

1. There is the demand of the prevention of the spread of fire in or on external wall assemblies.
2. The requirements for non-load-bearing external walls and non-load-bearing parts of load-bearing external walls. They have to be made of non-combustible materials or can be made of combustible materials if they are partitioned fire-retardant assemblies.
3. The material of the surface of external walls or cladding to external walls is defined as at least difficult combustible but the substructure may be made from combustible materials.
4. Actions against the spread of fire along façades with ventilated cladding or double skin façades.
5. Buildings of classes 1 to 3 (up to 7m height of the top floor level above the ground level) are excluded from rules in points one to four.

Non-loadbearing external walls in building class 4 / 5 may be made of building materials of class D–s2, d2 (e.g. wood) when the external wall construction fulfils the requirements of EI 30.

⁸ Kaufmann H., Lattke F., Ott S., Winter S. (2010) Gebäudemodernisierung in vorgefertigter Holzbauweise - Bauablauf, Aufmasstechniken, Konstruktion, Brandschutz. Mikado, (3), weka Verlag, Kissing.

⁹ Musterbauordnung (2002)

4.3.2. Hygrothermal (Heat, Air, Moisture) and Air / Wind Tightness

Basic requirements

There are several aspects to consider besides the improved thermal resistance from the additional layer made from insulating material. A new insulation layer reduces the heat transmission through the building envelope and reduces heating energy demand. Consequently the new layer, with its high thermal resistance, keeps the existing structure continually warm, that enhances user comfort by higher surface temperatures on indoor surfaces. In addition the rise of mould on inner surfaces is drastically reduced.

Hygrothermal Survey

The physical condition of the existing envelope of the building is the basis for the improvement of hygrothermal properties. The material, its properties and condition, e.g. moisture, cracks, leakage and construction details of the envelope have to be surveyed and documented. This documentation is the basis for the selection of an appropriate repair solution.

Conditions of the materials and constructions of buildings of the 1950s to the early 1980s.

The two main groups of constructions in existing buildings, the skeleton concrete structures and the punctuated masonry wall façades have different requirements in building physics.

(1) Skeleton / crosswall structures are less problematic, an entire new TES façade with connections to the front sides of walls or floor slabs will replace the existing, previously mounted façades that in most cases will be removed. The interior side of the TES façade has to be planned as a visible, interior finish and has to fulfil the requirements of thermal and moisture protection, air tightness, fire safety etc.

(2) Massive external wall structures cause several problems. They will stay in place in retrofitting cases. Nevertheless they may have various deficits, e.g. damages, dimension, material composition etc. The object specific damages come to light through a detailed investigation:

Construction thickness often limited to the minimum - resulting in low U-values
Thermal resistance of used material used is poor
Thermal insulation lacks or is minimal or lacking
Thermal bridges (floor / wall joints) in the façade
Airtightness is not guaranteed neither by inner rendering nor the sealing of wall joints
Poor and inconsistent construction material of the post war era results in cracked and sometimes unstable masonry wall structures
Insertions / built-in units have unstable joints and show gaps to neighbouring structures, e.g. windows
Damages due to lack of maintenance and repair in the façade, e.g. outer render layer
High moisture content in the existing walls due to diffusion or convection from the inside combined with poor drying conditions
High moisture caused by driving rain on damaged façade surfaces

High moisture due to capillarity as a result of inadequate construction, e.g. missing horizontal caulking.

In summary there is in many cases particular damage to the construction and problems of building physics due to poor materials and joints.

Damages are very often a reason for extra measures at an existing building. Existing, structural damage has to be repaired during the TES modernisation to ensure the functionality and safety of the building. In addition damages are also responsible for functional deficiencies of the surface that have to be repaired. Other purely visual aspects do not have to be repaired when these issues are solved by a new TES envelope.

Additionally there is a positive technical and economic aspect of the new TES layer, the protection of the existing structure and construction.

Heat and Moisture Protection

Heat and moisture protection of the entire wall composition, from the existing wall to the new outer TES layer, has to be ensured. This includes any fixed in parts of the existing construction i.e. front side of floors or internal walls.

Thermal Protection Winter

The building envelope needs good thermal protection properties by an insulation layer with very low thermal conduction of $\lambda \leq 0,1 \text{ W/(mK)}$, according to DIN 4108-2 or other national standards.¹⁰ Furthermore materials with a thermal resistance like timber and wood products helps to avoid thermal bridges.

Maximum heat transfer coefficient (U-value, minimum requirement)	EnEV 2007	EnEV 2009	Passivhaus Standard (minimum)
external walls	0,35	0,24	0,15
external wall with interior modernisation	0,45	-	0,15
pitch roofs	0,3	0,24	0,15
flat roof	0,25	0,2	0,15
basement ceiling and against soil, new	0,4	0,3	0,15
basement ceiling, insulation on cold side	0,4	0,3	0,15
basement ceiling, insulation on warm side	0,5	0,3	0,15
window	1,7	1,3	0,8
window, with new glazing	1,5	1,1	-
door windows, roof windows, special windows	2	1,4 - 1,6	0,8
doors	2,9	1,8	0,8
annotations	Introduction Energy = 2007 - 30% Pass		EU standard off 2011 = 2009 - 30%

20. U-Values of different construction parts and their historical development.

¹⁰ DIN 4108-2 Thermal protection and energy economy in buildings - Part 2: Minimum requirements to thermal insulation.

An additional thermal resistance to the existing façade can be added by a TES element with an appropriately thick insulation layer. The U-values of the building envelope are defined by the minimum requirements of the building code. The “*Passivhaus*” requires U-values that are even more strict than the code. Examples are shown in 4.3.3.

Thermal Protection Summer

Overheating in the summer is also a problem of poor constructions. They also need higher thermal resistance to avoid overheating. The specific heat capacity of common insulation materials and wood can be equal but is mostly lower than of heavy, mineral construction materials, e.g. concrete. This allows slow heating of the construction during the day and the use of the cooling effect at night in order to discharge the building mass. The phase shift of temperature maxima of outdoor and indoor, together with an amplitude dampening over the cross section, provide protection from overheating of living spaces. TES elements rise the overall heat capacity of a wall construction. The great advantage is the application of a TES in front of an existing massive wall. The combination of a smaller phase shift of the insulated TES element on the outside with the larger phase shift of massive mineral walls on the inside of a room improves the user comfort. Therefore the risk of overheating of the indoor climate in summer months will be reduced. If the windows are modernised additionally and a sun-shading is integrated in TES EnergyFaçade, which is done very efficient, the user comfort in summer times is reasonably higher than before modernisation.

Moisture Protection

Moisture protection ensures the durability of the construction, guarantees thermal protection and provides a hygienic indoor climate.¹¹

The driving factors of moisture problems are capillarity, diffusion and convection. A new envelope layer is mainly influenced by diffusion and convection. An intact existing outer wall with an intact render layer on the inside protects the new TES layer from moisture. The s_d values of existing walls are within the range that they can serve as the required vapour tight layer ($s_d = 2.5 - 15 \text{ m}$). Most critical to the new construction is the convection. This will be solved by the airtightness of elements, joints and penetrations as the existing wall and its render are assumed to be airtight. The latter point has to be regarded carefully in broken existing construction.

TES EnergyFaçade is a warm wall construction therefore the construction has to be protected against high moisture from the outdoor climate e.g. by driving rain. This defines the requirements for the façade layer, either to provide a water deterrent, ventilated layer or a water repellent layer. The drying capability has to be ensured in both cases by diffusion open materials on the exterior side.

Another positive effect of timber and wood based materials are their hygroscopic material properties especially high moisture buffering capability. Untreated wood surfaces show higher moisture buffering than for instance plastered surfaces as reported by Sedlbauer et al., 2004.¹² The absorption potential of the TES layer in the built-in situation helps to buffer vapour diffusion from wet, existing constructions or from the outdoor oriented side in the cold months. The maximum material moisture content must not exceed 20% of the TES timber construction, see also

11 DIN EN ISO 13788 Hygrothermal performance of building components and building elements - Internal surface temperature to avoid critical surface humidity and interstitial condensation - Calculation methods (ISO 13788:2001); German version EN ISO 13788:2001

12 Sedlbauer et al. (2004) Moisture buffering effects of interior linings made from wood or wood based products, Fraunhofer-Institut für Bauphysik (ed.), Stuttgart.

examples of dynamic heat and moisture simulation in 4.3.3.

Thermal Bridges

Reduction and avoidance of constructional, material and geometric thermal bridges is an additional task for the new and insulating envelope. The good thermal resistance of timber ($\lambda = 0,13 \text{ W/mK}$, for softwood) is a big advantage for these constructions. The TES layer is kept warm over much of its cross section. Therefore the temperatures in the load bearing, interior layer are far higher than the condensation temperatures. The fixation material, apart from the cladding, is also in the warm zone.

Avoidance of thermal bridges:

$$f_{\text{Rsi}} = (\theta_{\text{si}} - \theta_{\text{e}}) / (\theta_{\text{i}} - \theta_{\text{e}}) \geq 0,70$$

θ_{si} Temp. inner surface
 θ_{e} Temp. outdoor
 θ_{i} Temp. indoor

inner surface temperature has to be $>12,6^\circ\text{C}$, at 20°C indoor temp. and 50% relative air humidity. These conditions avoid the growth of fungi because there is not enough humidity available. This values have to the exception in energy efficiency modernised buildings. Only critical joints like window reveals or window frame joints can come close to this value.

Existing heat bridges, such as cantilevering parts of the façade, have to be insulated or removed from the building envelope. This is done by demolishing these parts and replacing them by an improved construction. A solution can also be an enclosure of these parts, positioning them inside the thermal envelope.

Also critical are geometric thermal bridges, e.g. around openings of the envelope in the existing structure as well as in the new TES layer. The joints of the windows have to be solved in a proper way that the window frames are positioned in the new insulation layer. The window frame and the reveals have to be insulated too, to avoid thermal bridges, as it is shown in the detail drawings.

Special solutions are needed for the reuse of existing windows i.e. by an effective insulation of the reveals. Another approach can be the provision of a second window in the new TES layer. A box type window solution has following advantages:

- combined, highly isolating window at lower costs
- thermal buffering by the air space between the two windows.
- integration of additional services, e.g. sunshading, controlled ventilation with heat recovery
- reuse of the existing window

Window joint

Two dimensional heat bridge simulation was done by the application of the simulation software. The used software was WinISO 2D Professional Version 6.12® for stationary two-dimensional heat conduction simulation. WinISO 2D is validated according to EN ISO 10211-1.

There are two main different models examined. The reuse of an existing window built in an existing external wall and a new window positioned in the layer of the TES element. The conditions are following:

The cross section of the existing wall has a U-value of $2,218 \text{ W/m}^2\text{K}$. External wall from inside to the outside:

15 mm render, interior

240 mm concrete wall, $\rho = 2400 \text{ kg/m}^3$, $\lambda = 0,040 \text{ W/(mK)}$

15 mm render, exterior

The TES element (from interior side to exterior):

50 mm gap between existing wall and TES element as adaption layer filled with mineral wool, $\lambda = 0,040 \text{ W/(mK)}$

4 mm wood fibre hard board

240 mm softwood studs and cellulose fibre insulation, $\lambda = 0,040 \text{ W/(mK)}$

15 mm gypsum fibre board

The complete wall cross section inclusive the TES element, as described above, has a U-value of $0,150 \text{ W/m}^2\text{K}$.

The assumed existing window has an aluminium frame with thermal separation of the frame profile made from plastic spacers. The assumed glazing is a two layer glazing with air filling. The U_w -value of the existing window is $1,7 \text{ W/m}^2\text{K}$ ($U_f = 2,0 \text{ W/m}^2\text{K}$; $U_g = 1,3 \text{ W/m}^2\text{K}$). The revolving mounting gap has a thickness of 12,5 mm for the aluminium frame and is assumed as intact and insulated with a compressible foam sealant. Normally these existing gaps have to be improved or repaired during façade modernisation because they are leaking due to missing or defect insulation and sealing.

A window frame has to be insulated on its exterior side in the window reveal in order to minimize heat transfer. The insulation material has to overlap the window frame with at least 30 mm of insulation in order to be consistent with the requirements of thermal protection standards. The chosen insulation thickness in the simulation model was 50 mm.

Conditions of the surrounding climate follow the definitions for heat bridge calculation, here DIN 4108-2. The outdoor temperature has to be -5°C and 80 % relative humidity (rH.) and the indoor climate is defined with 20°C and 50 % rH.

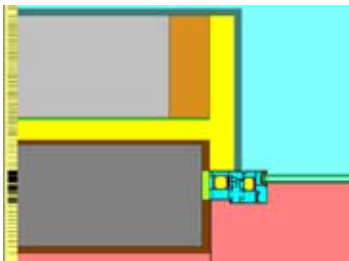

149. Situation of the simulated existing window joint. Aluminium window frame with outdoor climate (top) and indoor climate (bottom).

The simulation results show a steep rise of the temperature curve in the TES element and adaption layers, especially in the cellulose fibre, wood fibre hard board and mineral wool layers. The interior wall surface temperature is $18,35^\circ\text{C}$ and $-4,86^\circ\text{C}$ on the exterior façade side. This is a result of the good insulation properties of the TES element. The isotherms diagram shows a buckling of the isotherm lines towards the aluminium frame. The buckling is close to the adiabat border and indicates the inhomogeneity of the wall / window combination because of the poor thermal quality of the existing window compared to the TES element. The isotherms diagram also allows to locate the problematic section, marked with a vertical red line. The lowest temperature is located at the interior edge of the window frame, next to the gap between the aluminium frame and the existing wall. The temperature to be only $11,24^\circ\text{C}$ and therefore is below the minimum of $12,6^\circ\text{C}$. The $12,6^\circ\text{C}$ border is indicated as a red colored isotherm. The f-value calculated is 0,65 and is also below the minimum of $f \geq 0,7$. In consequence there will be moisture condensation on the interior side of the window frame which will penetrate the gap and damage the construction. The results show the necessity of improvement of existing poor windows together with the TES element. A possible solution is an additional closed window in front of the existing window, like a box type window. Another solution could be an additional insulation of the interior window reveal. Both approaches have to be examined in detail in the forthcoming SmartTES research project.

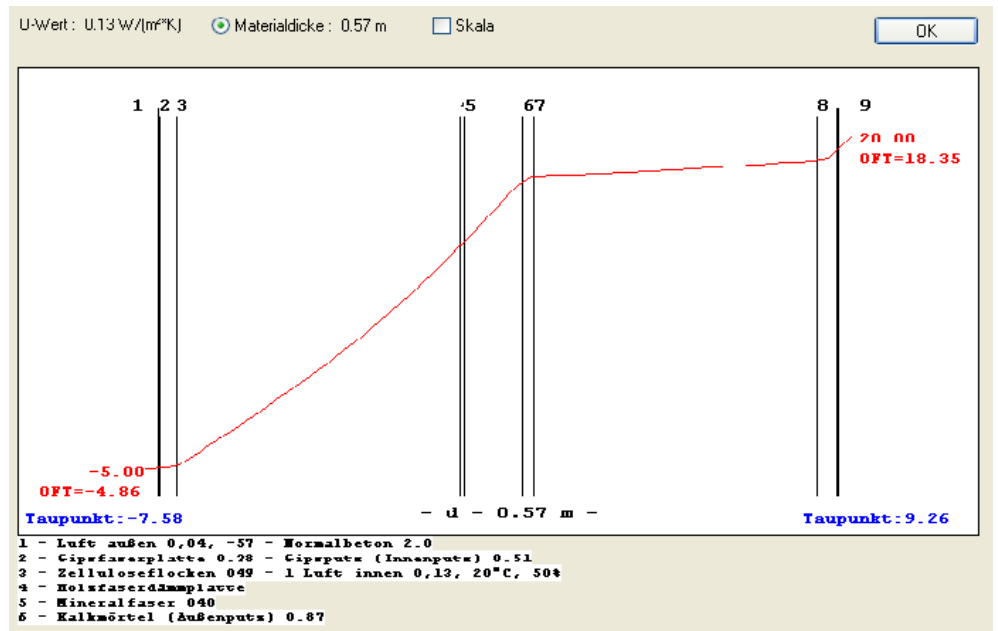

150. Temperature diagram of the section through TES and existing concrete wall.

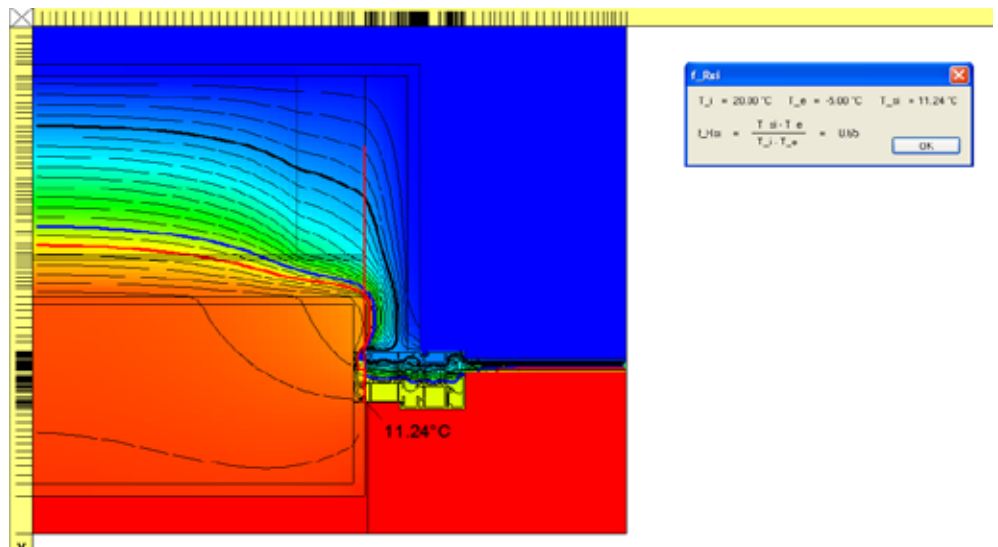

151. Isotherms of the wall/window section. Lowest indoor temperature is indicated with 11,24 °C.

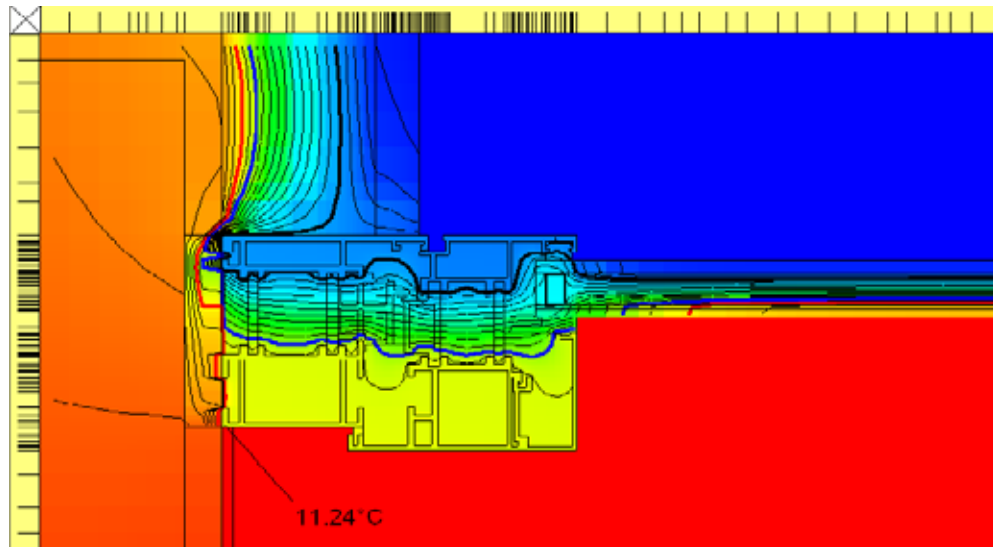

152. Detail view on the coldest indoor surface point.

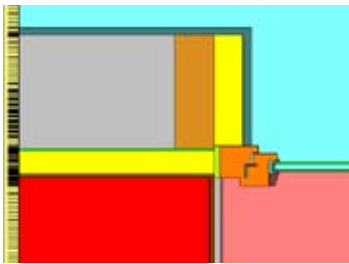

153. Situation of the simulated new window joint in insulation layer. Timber window frame with outdoor climate (top) and indoor climate (bottom).

The other window position examined is in the adaption layer, close to the rear side of the TES element. The assumed new window fulfils the requirements of the EnEV 2009 with an U_w -value of $1,3 \text{ W/m}^2\text{K}$ according to EN ISO 10277 - 2 ($U_f = 1,2 \text{ W/m}^2\text{K}$; $U_g = 1,1 \text{ W/m}^2\text{K}$). The chosen quality of the window is not exceptional high in order to check the risks of a minimal requirements solution. The frame is made from timber with 68 mm profile thickness and the glazing is a two layer isolating glass with krypton gas filling. The revolving gap for mounting between the existing opening and the window frame is 15 mm perpendicular to wall and 7,5 mm parallel to the wall. The gap is filled with compressible insulation foam. The offset between the TES element and the existing façade opening is used like an exterior rebate for the window. The exterior insulation of the window frame is 50 mm thick. The isotherms are parallel to the existing wall and the red line, indicating the $12,6^\circ\text{C}$ border, continues in the cellulose fibre layer. Close to the window the isotherms are shifting towards the rear side of the TES element and continue in the window frame. The interior surface temperature of the window frame close to the joint gap is $16,19^\circ\text{C}$ and the f -value is 0,85, both values are on the safe side. Another window position in center of the TES layer is also possible, because the red isotherm is inside the TES layer. Supposed that the window frame has a U -value comparable or better as the examined one.

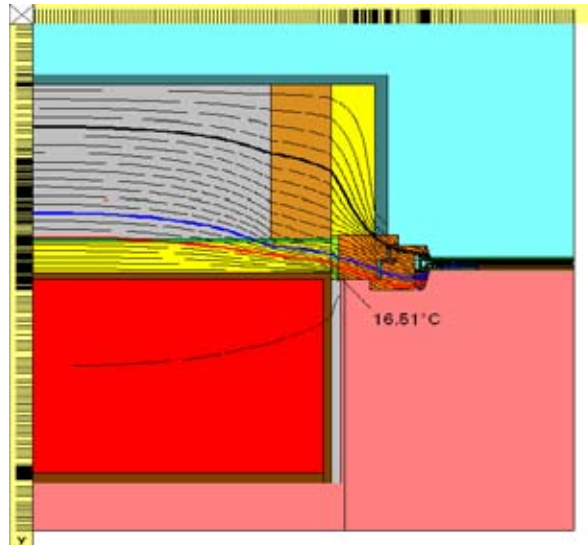

154. Isotherms of the wall/window section. Lowest indoor temperature is indicated with 11,24 °C.

Advanced solutions for window joints and minimisation of heat bridges will be developed in the SmartTES project.¹³

Air tightness

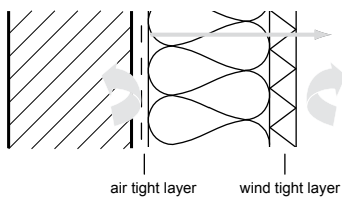

155. Moisture and wind protection, interior side (left) with air tight layer and exterior (right) with wind tight layer.

Well insulated buildings often prove to exhibit bad indoor air quality if only the construction was improved. The previous natural ventilation through gaps or cracks has been interrupted by the improvement of the air-tightness. The positive effect is the reduction of ventilation heat losses.

The building code puts limits on ventilation heat loss and requires an airtightness of the envelope of $n_{50} \leq 3$ (or $1,5$) h^{-1} (EnEV 2009 without / with mechanical ventilation). The “*Passivhaus*” requires $n_{50} \leq 0,6$, whereby a mechanical ventilation is obligatory to ensure the indoor air quality.

Air tightness is also the guarantee to avoid moisture transportation into the structure by convection, which would lead at cold exterior areas of the structure to high amounts of moisture content or dropping water.

The new TES insulation layer also has to provide the wind-tightness on the outer side, to avoid the cooling of the insulation by convection. The horizontal and vertical joints between the elements also have to be wind-tight.

The inner side of the TES element does not need to be air-tight, if the existing masonry or concrete walls are considered sufficiently air-tight thanks to the render layer on the inside of the wall. If it is not possible to ensure the airtightness of the existing structure, an additional airtight layer may be placed between the old construction and the new TES element. However, all joints of the TES elements with the existing construction have to be sealed air-tight, e.g. window openings. No open gaps between the existing wall and the new insulation layer are allowed. Therefore TES elements have to be sealed around every penetration.

13 <http://www.smarttes.com>. Project website of SmartTES.

4.3.3. Cavities in Adaption Layer and Drying Potential in Existing Wet Walls

It is possible to reduce moisture content in existing walls by applying external insulation with TES elements. Continuous warm conditions of the existing structure allows the drying of existing wet walls. The drying process follows a thermal, relative air humidity or vapour pressure gradient which activates a diffusion process. The diffusion can be supported by diffusion open constructions with low s_d values (from 2,5 to 15 m on the inside and with a ratio of 5 - 10 on the outside layer results in 0,5 - 1,5 m). The layers on the outside or close to it have to be more diffusion open than the ones on the inside. In technical terms this means s_d values descend from the inner layers to the outer layer. Diffusion to the inside of the building allows higher drying capabilities during the summer period. In addition the construction material should show good moisture absorption capability, e.g. cellulose or wood fibre products.

	Interior surface	Wall	Exterior Surface	s_d - Value [m]
Reinforced concrete 24cm	15*0,02	80*0,15	50*0,015	13,35
Masonry, 1600 kg/m ³	15*0,02	5*0,24	50*0,015	2,55
Masonry, 900 kg/m ³	15*0,02	5*0,365	50*0,015	3,175
KS 1600 kg/m ³	15*0,02	15*0,20	50*0,015	4,35
Leichtbeton 1800 kg/m ³	-	70*0,20	-	15,35
compare PE-foil: $s_d = 50$ m				
compare OSB: $s_d = 0,45 - 0,75$ m				
Preliminaries: $s_d = \mu \times d$. KZ render $\mu = 15-35$, KH render $\mu = 50-200$, Tiles $s_d = 2$ m; all construction are missing additional layers of paint on interior and exterior: $s_d = 0,1-0,5$ m				

21. s_d -Values of existing wall constructions.

The adaption layer between TES and the existing wall has to be filled as shown above, so that the drying of the existing wall is possible without damaging the new TES elements. The moisture buffering capability of the cellulose fibre captures the moisture during the cold winter months and release it in summer months. This leads to a good drying process of the existing wall as well as the TES elements.

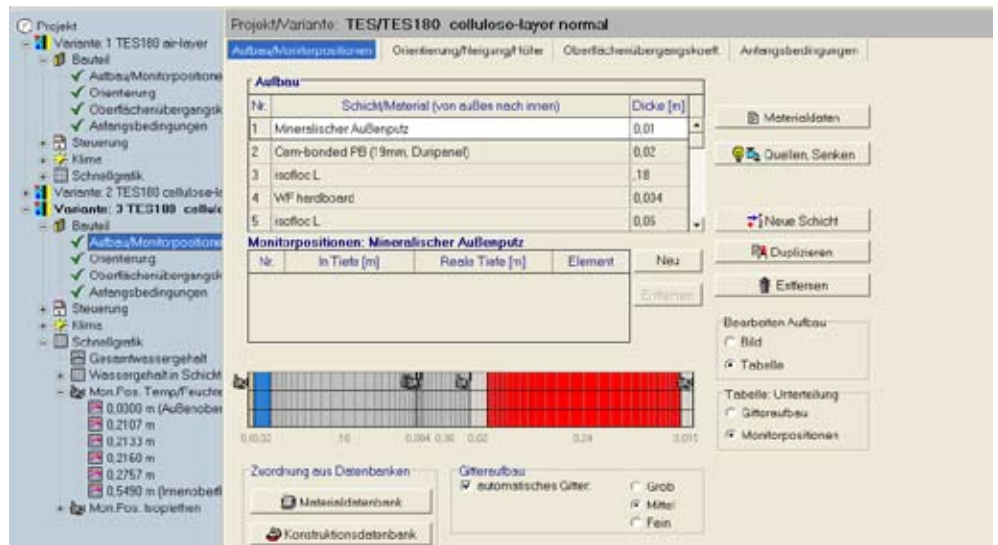

156. Material properties and dimensions list, screenshot of WUFI® 4.2.

Conditions: Climate data applied was related to the town of Holzkirchen, Bavaria, Germany. The town has a typical climate of mountain regions of the alps with a lot of rain, cold winters and warm summers with average temperatures of - 5 in winter months and + 25 °C in summer.

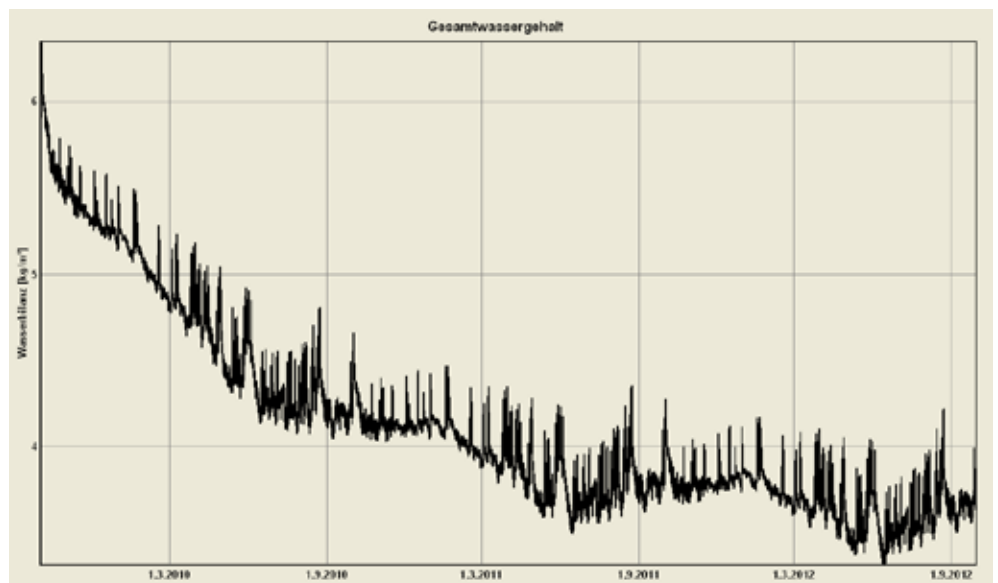

157. Simulation of existing wet wall with 18 cm TES EnergyFacade done with WUFI® 4.2. The graph shows the decrease of the total amount of water in the entire, insulated exterior wall construction

TES Element: a minimum insulation of 180 mm from cellulose fibre, exterior panelling with a cement-bound building board and an outer render layer and interior panelling with a thin wood fibre hard board. The adaption layer is filled with 60 mm cellulose fibre. The existing wall consists of 240 mm of masonry work and rendered on both sides. The existing wall was assumed to be in a wet condition at initial simulation time (existing render 45 kg/m³ and masonry 13 kg/m³ water content).



158. Temperature and dew-point diagram of the adaption layer during a range of three years. The red line indicates the temperature curve while the pink line shows the dew point temperature. The position is on the outside of the wood fibre hard board or the interior side of the TES element.

The results show the dew-point temperature at the edge of the adaption layer to the rear panelling, indicating that there is no risk for the existing construction. The water content decreases from 15,2 % mass below the amount of 9 % in the simulation time span of 3 years. The wood fibre hard board layers show a similar behaviour. The overall moisture content also decreases over the whole construction. This indicates that the proposed construction will have enough moisture buffering and drying capabilities and will not be damaged in central European rough mountain climate conditions.



159. Humidity diagram of the cellulose fibre insulation layer shows the good drying capabilities during a range of three years. The overall mass of moisture in the element decreases.

4.3.4. Acoustics (Sound Protection)

Basic Requirements

Façades and outer walls have to fulfil the properties of sound protection of airborne sound as well as structure-borne sound. The local acoustic situation has to be taken into consideration as it would in a new building. The regulations and technical standards, DIN 4109¹⁴ in Germany, and EN 12354¹⁵ as a European standard set the requirements. The planning and construction of TES EnergyFaçade has to avoid the airborne sound transmission by proper caulking of gaps and joints. Structure-borne sound emerges by impact sound or by the operation of e.g. built-in parts. Here the transmission paths have to be de-coupled. It is worth considering the entire façade composition from the inner to the outer surface, including the existing structure. In addition neighbouring cavities are also part of the sound protection concept.

Sound Survey

This examines the existing construction for their sound insulation capabilities and sound spread traces in façades. Flanking sound is the most critical transmission path there.

The personal impression of the tenants will give the first hints of the existing sound protection. Acoustic recognition is experienced very differently by different individuals. A façade modernisation improves airborne sound protection, especially of the windows. This has side-effect of a better recognition of other noise from internal sources. This is a subjective impression and has nothing to do with acoustic leakages in the envelope rather the acoustic quality of the construction of the interior walls.

There are different requirements for sound attenuation of an outer wall in front of a skeleton structure compared to a monolithic masonry façade. This has to be taken into consideration when a new building envelope is planned.

Existing Conditions - Anamnesis

Thin walls and poor construction standards of the 1950s to 1970s in general cause problems for sound insulation, due to thin constructions and windows with single or thin 2-layer glazing. Windows are mainly subject to airborne sound impact. Lightweight façade constructions of this time, showing minimal infills and fluffy insulation material with specific weight below 50 kg/m^3 , are problematic due to their minimal sound control capability. This type of façade also has heavy flanking sound problems. Existing façades from the same era made of a monolithic construction have less severe problems, due to the absorption capability of high specific masses.

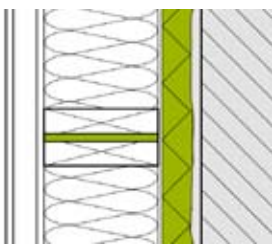

160. Horizontal decoupling of elements and adaption layer decoupling existing wall.

TES Sound Protection

The de-coupling of the existing construction from the new element is achieved by means of an adaption gap which is filled with an adaption layer from an absorptive and soft material. The first action is the closing and filling of the gap to ensure the separation of the two shells. Quality control during mounting has to prevent inclusions or rubble between the shells by clean working conditions. This is necessary to avoid contact and structural sound transmission.

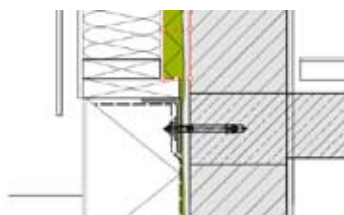

161. Brackets and sill beam as linear anchoring solution with decoupling on the sill..

14 DIN 4109 Sound insulation in buildings; requirements and testing.

15 DIN EN 12354-1 Building acoustics - Estimation of acoustic performance of buildings from the performance of products - Part 1: Airborne sound insulation between rooms; German version EN 12354-1:2000.

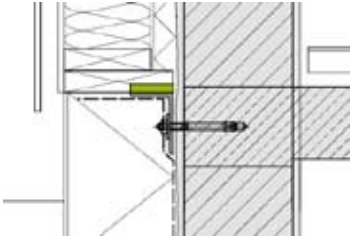

162. Brackets as punctiform anchoring solution with decoupling on the bracket..

De-coupling of supports (brackets/elements) with special underlying elastomer. This measure reduces the sound transmission through joints of the new shell to the existing structure. Skeleton structures with fully or partially inserted façade elements also need a flanking sound control by elastomer support and suitable caulking. Quality control --> cleaned and correct fixed elastomer supports and bearing area of the façade element.

Decoupling of joints by separating the structures and the elements. The transmission from one element (compartment) to neighbouring ones has to be reduced.

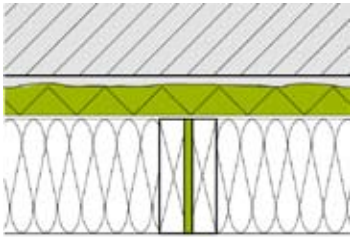

163. Vertical decoupling of elements and adaption layer decoupling existing wall.

Another source of noise comes from the building services. When HVAC for the dwellings is integrated into the TES EnergyFaçade this source of noise is integrated in the façade. The required installations has to be soundproofed, all routing has to be insulated, and all pipe-work penetrations of the building envelope with piping have to be de-coupled with adequate constructions. Air ducts for ventilation have to be equipped with sound absorbers.

4.4. Building Services

As part of the research project, we investigated on the possibility of integrating building services into TES elements and developed a basic concept for the task. There will be an in depth examination of this topic in the SmartTES research project.

Basically, the integration of building services, e.g. ductwork and installations, within the TES element provides added values to the retrofitted building envelope and gives a greater freedom and flexibility in the design of ground floor plans. As with installation space in interior walls, services can be applied within the layers of the building envelope, taking the following basic principles into consideration:

Separate installation modules, zones or channels must be formed

Insulation properties of the channels should be the same as the wall element.

Technical, fire safety, air tightness and soundproofing standards must be guaranteed

TES must be designed in full compliance of official building regulations

Depending on the size and function, the services may be fully integrated into the timber frame element or mounted onto the existing façade, to be later covered by a TES element. The level of prefabrication is determined by the type of service and the location within the envelope.¹⁶ We distinguish between installation zones and ducts. Zones are areas on the façade, where piping or cables are fixed directly on the existing wall. Ducts or channels are separate cavities for the leading of pipes with larger diameter.

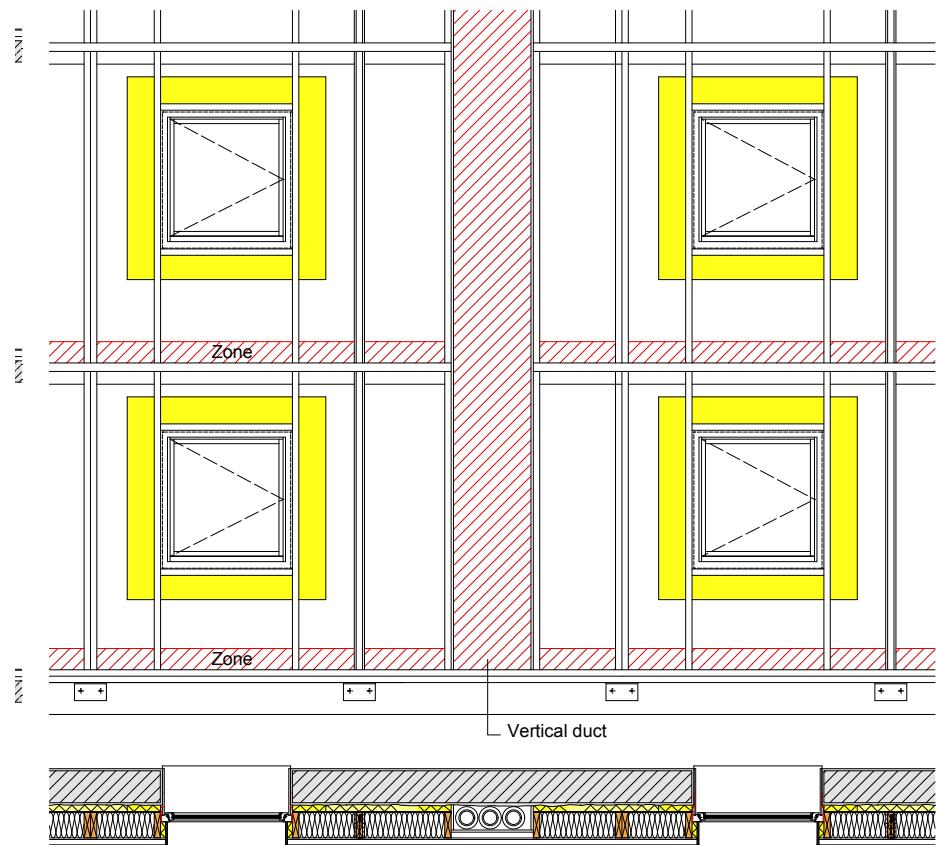

164. Concept of building service integration

¹⁶ <http://www.empa-ren.ch/a50.htm>, IEA ECBCS Annex 50, "Prefabricated Systems for Low Energy Renovation of Residential Buildings", verified 04.07.2010.

Concept of building service integration

Utilities

- Phone, LAN, Power
- Plumbing, Heating, Waste water
- Ventilation
- Solar thermal systems
- Photo voltaic

Requirements

- Fire safety
- Air tightness
- Sound insulation
- Energy saving regulation (EnEV)

Assembly direction of services

Vertical



Horizontal

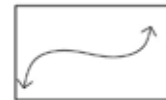

Random

**Zone****Duct**

On-site:
mounted on the
façade, covered
by TES element

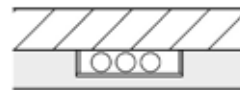

Off-site:
integrated into
TES element

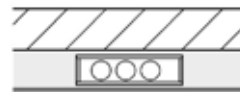
**Module**

e.g. thermal col-
lector or photo
voltaic panel

**Pipe lead through****Maintenance**

- Accessibility
- Service interval
- Life-span / demountable
- Life cycle assessment

Installation zone

165. Vertical section with possible installation zone in adaption layer.

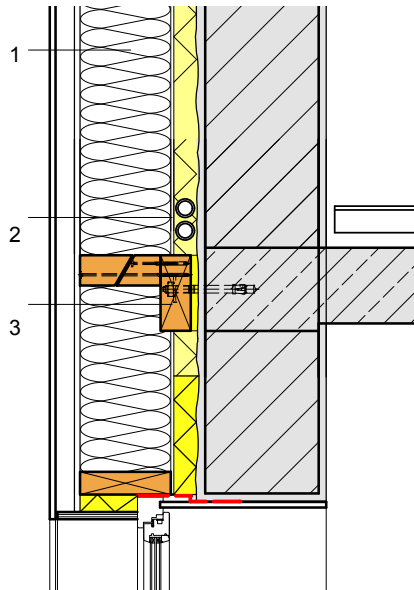

- 1 TES element
- 2 Installation zone
- 3 Bracket / joint at ceiling height

The adaption layer between the existing façade and the TES element offers enough space to install cables or pipes. The complete filling of the cavity with insulation material has to be considered when installing the services. Therefore the space above the element joint at ceiling height offers the ideal location for heat pipes or electric cables, which will be connected to the interior closely above floor level. As regards workflow, it is considered best to mount services before fixing the TES element.

Requirements:

- Fire safety of material (pipes, cables etc.) and lead through
- Air-tight sealant of lead-through

Utilities:

- Phone, LAN, electricity
- Plumbing, heating

Installation duct

Piping for waste water and air conditioning requires space which can be provided in separate ducts. The following requirements must be considered when integrating ducts into the building structure.

Fire safety:

1. Duct as independent vertical fire compartment which has to be separated from other fire cavities in the building structure
2. Duct is part of a compartmented area and separated vertically through fire barriers

Sound insulation

Avoidance of heat bridges

166. Horizontal section shows example of ductwork.

- A Insulation (e.g. Vacuum Insulation Panel = VIP)
- B Duct work
- C Cladding, fire protection

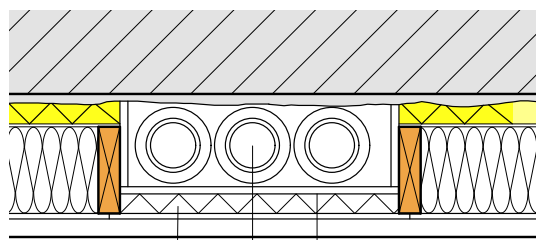

Utilities: A B C

- Water, heating
- Waste water, drainage
- Ventilation



167. Transport of lying elements on bridge plate.

Case study: Modernisation of a 2 storey residential apartment building in Zurich, Switzerland

Site visit: 23.06.2009 - 10.00 h
 Address: CH - Höngg (Zürich), Segantinistrasse
 Architect: Beat Kämpfen
 Badenerstrasse 571, CH-8048 Zürich

Status quo of the existing building:

two storeys, four apartments
brick wall
double pitch roof

Design:

Removal of the roof, provision of additional floor
Flat roof
Addition of enclosed balconies as extra "in-between" space
Prefab wall elements for improving the energy efficiency of the external wall
Integration of HVAC within the building envelope



168. View from east (street side): the green plastic sheeting protects the new elements



169. View from north:
 The extra top floor enjoys a spectacular view over Zurich and the mountains. The expected rent income „finances“ the modernisation of the whole project



170. Layering of element in front of existing wall (left side).

Layers:

- Existing rendered brick wall
- Space (app. 2-5 cm)
- Stud
- Cement fibre board
- Timber fibre board



171. Roof extension of existing apartment block.

The walls of the additional floor are set back, positioned in line with the existing walls.



172. Basebeam with styrofoam insulation



173. Beam carrying the load to the first floor ceiling.



174. Vertical HVAC routing.



175. Weather protect elements (left) and HVAC routing vertical (right) and horizontal (top right).

Space for an additional room (Rucksack) for the installation of a central HVAC and heating pump on the north façade of the building. Notice the number of pipes coming together at the top.

HVAC installation

The ventilation pipes are integrated into the new wall elements leading from a central space on the north façade around the building at the setback of the top floor. The piping is mounted in situ from a scaffold after the timber elements are mounted. At the end the timber frame will be filled with blown cellulose fibre. The informations regarding the requirements of airtightness, fire safety and maintenance were not available.



176. View from above into the recess left is the top of the new element right is the wall of the raised floor



177. View of the bundle of pipes leading down into the central HVAC space



178. View into the setback. Transformation from horizontal to vertical pipe leading. This pipe is connected a lower floor.



179. Pipe lead through above a window

Lessons learned

If HVAC pipes are to be integrated into the timber elements, a clear concept of pipe routing is essential. Space requirements as well as the those of building physics and fire safety have to be considered.

The connection of pipes at the wall break-through is a standard detail and can be done from the interior.



5. Quality Assurance

5. Quality assurance

Specific properties of the existing building envelope will be improved by using TES elements in an energy efficient retrofit project, e.g. thermal insulation, functionality of the façade, design and appearance etc. These features raise expectations on the clients side which have to be met during and after the building process as a predefined quality standard. A quality retrofitted project conserves values and represents long lasting valuable investment.

A satisfying result can be achieved by a consistent quality assurance system along the process chain from design, production, assembly and maintenance. The overall objective is to ascertain that all predefined standards will be reached and that the building as a system of envelope and conditioned interior space will function to the needs of its users and the expectations of the client. Hence the definition of project objectives at a very early stage as well as the integration of a quality assurance system (QA) is an important part in the retrofit process.

Typical project stages:

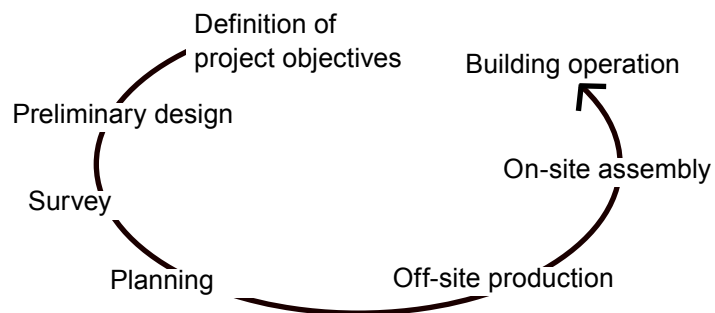

Contractors (e.g. carpenters) are not able to achieve the high quality standard alone, they are not solely responsible for the building process. Planning and project organisation have a large effect on the outcome. Therefore all participants in the building process have to be involved in measures of quality assurance measures through out all phases.

Tasks of a Quality assurance system include:

- Predefinition of object-related quality standards for planning, production and assembly
- Surveillance of those standards (e.g. structural behaviour, fire safety, heat- and moisture protection, sound insulation etc.)
- Securing and reviewing these standards through continuous internal and external supervision
- Provision of tools for clients, planners, and builders to avoid errors in the application of the regulations and streamlining the work
- Strengthen error prevention
- Provision of tools for clients, planners, and builders to avoid errors in the application of the regulations and streamlining the work

The participants involved commit themselves to a comprehensive project surveillance in order to meet these objectives. The timber contractor operates within existing national regulations (e.g. RAL Gütesicherung¹, Germany).

5.1. Regulations

Generally recognised rules of technology as well as the relevant national building regulations must be respected in design and construction of TES elements. The existing norms and quality regulations cover definitions for material and product properties as well as procedures for internal and external production control. In addition, timber contractors may commit themselves to voluntary quality assurance systems such as RAL (Germany).

One of the key objectives of national building regulations as well as harmonized European regulations is that any construction work or completed construction shall satisfy the requirements in regard to safety, health, the environment and serviceability.

The following regulations and surveillance measures assure defined quality standards of building materials, production and assembly of TES elements:

Construction material	<ul style="list-style-type: none"> • Conformity (Ü and CE) • Technical approval • DIN EN • Incoming goods inspection (humidity, specification)
Production	<ul style="list-style-type: none"> • Internal (self-) control • External monitoring • RAL quality label (RAL-GZ 422/1)
Timber frame element	<ul style="list-style-type: none"> • Conformity (Ü and CE) • DIN EN
Assembly	<ul style="list-style-type: none"> • RAL quality label (RAL-GZ 422/2) • Blower Door / thermal imaging • Metrological coordination (referenced grid) • Visual check • Caution of workers on-site

1 Part 1 [RAL-GZ 422/1], Herstellung vorgefertigter Bauprodukte (Production of prefabricated construction products).
Part 2 [RAL-GZ 422/2], Errichtung von Gebäuden (Montage), (Construction of buildings (assembly)).

5.2. TES Specification

Securing quality standards within the TES process requires the definition of requirements for the implementation, responsibilities and quality surveillance.

Objectives, contents and quality standards of TES elements are defined along the process chain by planning, energetic simulation, tendering, project documentation and workshop planning.

A set of properties is defined by the client or architect at an early stage, as common project objectives. Within the project scope, requirements regarding building regulations, building physics and technical features have to be determined and technically fulfilled.

This holistic view of the TES process, forms the basis for a satisfying project outcome, with frictionless workflow of within modernisation process a clear project structure of responsibilities and a professional communication structure.

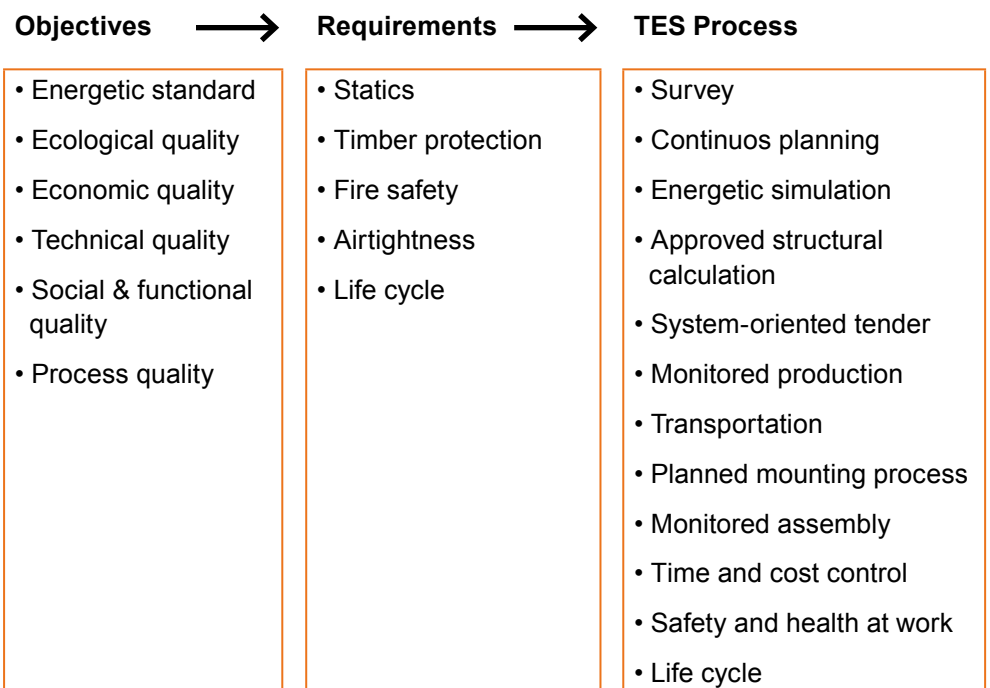

The monitoring and evaluation of several built projects along with standard procedures and existing quality assurance systems for timber construction are the basis for the following planning recommendations for TES EnergyFaçades.² These should be understood as additional advice along the project workflow. They do not replace common planning and production procedures or QA systems.³

The aim is to support the planners and builders with knowledge for specific tasks within a coherent process, as an optimal result can only be achieved by a broad understanding and respect for the entire project workflow.

² RS Buchloe, Neue Burse Wuppertal, KiGa Kamper Weg, Bad Aibling, ABG Frankfurt, GWG München, College Risor, etc.

³ <http://www.iee-square.eu>. For example: Kovacs, P., Mjörnell, K., SQUARE - A System for Quality Assurance when Retrofitting Existing Buildings to Energy Efficient Buildings, last checked 17.08.2009

5.3. Design Recommendations for TES

Primary Investigation

- Architect, Engineer

The investigation of the building structure and the construction is a vital planning basis. It reveals weak points of the building envelope as well as the structure and gives necessary information for the planning and the fixation of TES elements.

Building site

- Accessibility and surrounding
- Other buildings (shade)

Building inspection

- Building inspection report
- Archive drawings, documentation
- Thermal imaging camera results
- Photographs
- Current primary energy demand figures

Construction

- Analysis of general structure of the construction (adaptability / changes)
- Defect detection in structure and construction
- Load bearing capacity and definition of points / zones for fixation
- Existing Joints
- Building layers or elements to be removed

Building regulations

- Status of fire safety measures (do they meet today's standards/requirements?)
- Documentation of relevant information for building approval (building class, parking, occupation of rooms etc.)

Survey

- Surveyor

The survey results in a digital 3D model of the building which reflects the building geometry, the structure and the construction and is based on the precise 3D measurement of a thorough survey. This is key for the design and fixation of the elements, in particular to avoid the need for alteration of the elements on site.

Measuring

- Precise, redundant measuring (Photogrammetry, Tachymetry + TLS) (equipment calibration X mm)

Handling of digital data

- Registration of point clouds
- Frictionless, non-scaling data import, data integrity
- Simplified model + backup and availability raw data

- Availability of whole data during the design and planning process (“blue print”)

Tolerances

- Topography ± 8 mm
- Edges, corners ± 10 mm
- Windows ± 10 mm

Energy Analysis

- Architect, Engineer

A comprehensive analysis of the present energy status of the existing building envelope with a description of U-values, structure of building components and HVAC systems. This forms the basis for the definition of planning objectives and properties of the future building envelope.

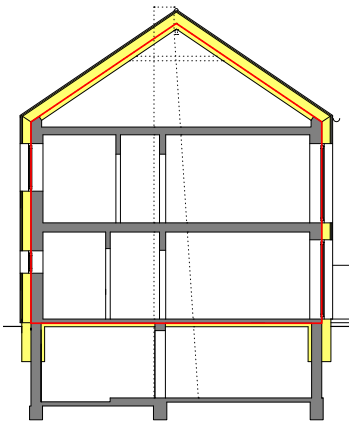

180. Insulated building envelope

Data basis

- Building documentation (construction and U-values of the building envelope, potential thermal bridges)
- Analysis of construction in situ
- Operational monitoring programs
- Present energy consumption data
- Structural analysis

Concept

Definition in planning stage:

- Setting the goal for the energy efficiency level
- Heating energy demand (e.g. DIN 18599) as basis for an energy declaration
- Definition of air tight layer and air tight joints (e.g. window frame)
- Avoidance of thermal bridges

Integrated planning

- Architect, Engineer, Carpenter

Integrated planning requires the involvement of surveyor, architect and engineers at an early stage. Furthermore, the integration of the timber consultant at this stage is advisable if the contract model allows it.

TES specific planning contents

- Survey material + 3D model, IFC format
- TES design 3D(CAD 3D design)
- Visualisation 3D (if required)
- Structural design 3D
- Building services design 3D
- Interactive, dynamic energy simulation (recommendation)
- Fire safety concept and fire simulation (if required)

Communication

- Joint interpretation of survey plans

- BIM - digital planning data (e.g. 3D model from survey to engineer for interpretation of the data)

Workshop drawing

Based on:

- Approved structural calculation
- Approved building documentation
- Approved fire safety concept

System-oriented tender

- Survey (if the survey is part of the responsibility of the contractor)
- Workshop drawing (approval by the planner before production)
- TES Elements with property definition of all layers, joints
- Integration of windows, HVAC, sun shading device etc.
- Definition of material for fixation, seals, foils etc.
- Site arrangements
- Mounting process
- Documentation of workshop plans



181. TES elements on a trailer.

Off-site fabrication and transportation

- Carpenter

Elements are manufactured according to element designs. During fabrication it must be ensured that elements are protected against dirt, breakage and moisture. The quality surveillance of the production process is the timber fabricator / contractor's responsibility. The timber contractor must operate within the relevant national regulations and in additional, voluntary quality assessment systems (e.g. RAL Gütesicherung, Germany).

Data transfer

2D files, prints (dwg, dxf) and/or 3D model to element manufacturer

Material

- Use of building materials according to their specification, i.e. strength category, thermal transmittance, water vapour transmission rate etc.

Production

- Marking TES elements according to their final position
- Documentation of an internal and/or external quality surveillance system
- Approval by architect

Logistics and transportation

- Max. size of TES elements according to transportation restrictions
- Protection of TES elements during transportation and site arrangement



182. Assembly of TES element.

On-site assembly

- Carpenter, Architect, Engineer

TES elements must be lifted and assembled according to the assembly plan and instructions by the element manufacturer. They must be stored, moved and assembled on-site without any damage.

Building site facilities	<ul style="list-style-type: none"> • Choice of appropriate heavy lifting equipment, positioned with consideration of operation space • Planned assembly process with consideration of time slots for preparation, dismantling of structures and/or layers of the existing envelope and lifting / mounting of the new elements.
Precision	<ul style="list-style-type: none"> • Utilisation of fixed base grid and points at assembly • Measurement of fixation points (e.g. brackets)
Construction surveillance	<ul style="list-style-type: none"> • Quality surveillance according to national and international standards • Protection from contamination of the existing substance during the assembly if the building is retrofitted under operation • Visual check of tightness of joints and air tight layers • Blower door test
Protection	Protection of TES Elements in addition to factory protection with tarpaulins from rain, wind and dirt if needed.
Health and safety	Respect regulations, especially for the work on the scaffolding while lifting large scale elements between the building and the platform.

Life cycle engineering

Maintenance simulation over a life-span of 50 years or more as part of the planning phase.

Planning	<ul style="list-style-type: none"> • 4D as-built model to client • Utilization of fixed base grid and points in maintenance • Utilization of dynamic energy simulation in maintenance
Life cycle	<ul style="list-style-type: none"> • Define maintenance costs • Detail for demountable building elements (e.g. cladding, windows) • Long term maintenance intervals

A low-angle photograph of a modern building. The building features a glass facade on the left side and a dark, horizontally-slatted facade on the right side. The sky is a clear, bright blue. The text "6. Pilot projects" is overlaid in white at the bottom center of the image.

6. Pilot projects

6. Pilot Projects in Europe



183. Overview of pilot project locations

Projects investigated:

Germany:

Student housing “Neue Burse”, Wuppertal, Müller-Schlüter Architekten.

Stadtwerke Entsorgungsbetrieb, Remscheid, Müller-Schlüter Architekten.

School building, Kamperweg, Düsseldorf, Architekt Wollenweber.

Switzerland:

Apartment house, Zürich-Höngg, Architekt Beat Kämpfen.

Pilot Projects:

Finland

Oulu Student house

Germany

Realschule Buchloe, e3 Architekten.

GWG München, Kaufmann Lichtblau Architekten.

Norway

Risor College

6.1. Realschule, Buchloe, Germany

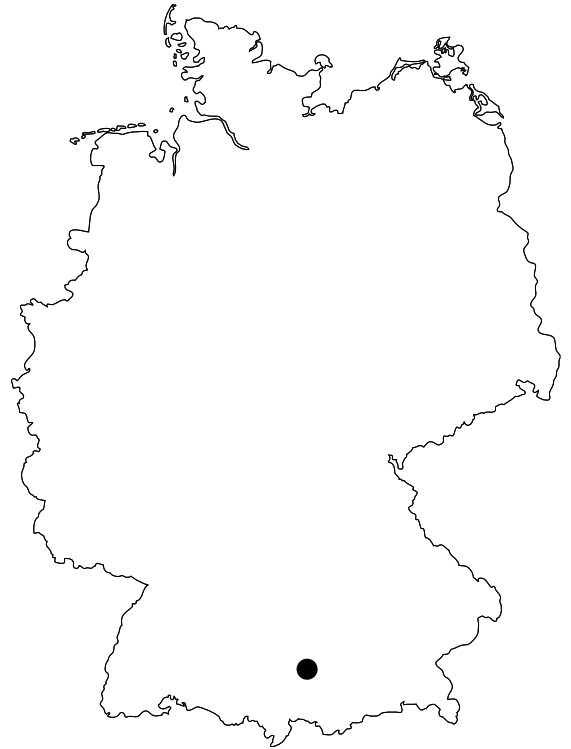

184. Realschule Buchloe, Germany



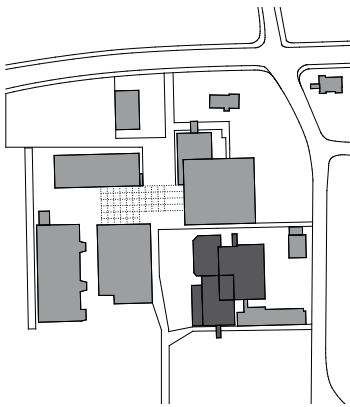

185. Site plan 1:5000

Project Facts

Client: County of Ostallgäu, represented by county commissioner Mr. Fleschhut

Location: D-86807 Buchloe, Kerschensteinerstraße 2

Design and Energy Concept: e3 Architekten, Marktoberdorf

HVAC: IB Fink & Janda, Kempten

Electrics: IB Körbl & Feneberg, Füssen

Structural design: Mühlberg Ingenieure, Buchloe

Fire safety: IB Reinhard Schulz, Buchloe

Survey: Weidener & Strobl GbR, Mindelheim

Timber Construction: Ambros Holzbau, Hopferau

Net heated floor area: 8.903 m²

Gross building volume: ca. 27.822 m³

Heat energy demand (planned): 16 kWh/m²a (PHPP)

Primary energy demand (planned): 34 kWh/m²a

Cost (façade): 1,38 million € gross (KG 300+400)

Costs (interior, HVAC and electrics): 2,0 million € gross (KG 300+400)

Costs (total): 5,1 million € gross (KG 200 - 700)

Construction year existing building: 1980

Completion (façade): September 2009

Completion (interior, HVAC and electrics): 2011

GWP (new façade without demolition): 20 t CO₂equ. (Timber façade elements have a bonus of -63 t CO₂equ., all other materials (such as glass, metal claddings and steel fixings) come in substantially higher at +83 t CO₂equ.)

Biotic resources mass: 92 t softwood

Basic Concept

Energy efficiency was the top priority for the complete modernisation of this school building built in 1980. This was the task for the Marktoberdorf based architectural studio e3-Architekten. Before the refurbishment, the school had a primary energy demand of 125 kWh/m²a.

The major constraints to the project was the requirement for the continued operation of the school have to be guaranteed with a minimised expenses for temporary shelter and time span of disturbance: The local authorities had no possibility of providing adequate alternative accommodation during the modernisation. The regular school operations for 850 pupils aged between 10 and 17 years had to be ensured on most days from 8 a.m. until 3 p.m. This would typically lead to immense expenditure for a building envelope modernisation in the remaining time available. Today's common energy efficient retrofitting methods are characterised by high levels of manual work, maintenance effort, demolition costs, unresolved utilisation and short life span. In addition, these methods are time intensive, unergonomic, are associated with high emissions of dust and noise, unecologic and based on non-renewable resources.

Modernisation in multiple phases, with interventions in the building envelope and



186. Existing school building



187. Existing building entrance

essential components of the building services are notoriously hard to achieve while the object is in full operation. The modernisation of a façade demands a planning concept that encompasses the complex requirements for the user comfort – especially in school buildings.

As a result, the option to use prefabricated façade element assemblies is particularly attractive. The architects developed a two stage process for the modernisation. In the first stage the entire building envelope was renewed over a period of six weeks during the school summer holidays. The architects opted for the application of prefabricated timber framed elements. The elements were delivered to site with windows and glazing already integrated and were mounted in front of the existing concrete skeleton frame. These elements build up the new and highly insulated, wind and air tight outer hull of the school. The development and installation of the timber framed elements was monitored by the TU München.

The second stage of the retrofit was undertaken the following year with a section by section refurbishment of the interior. During this work only a portion of the pupils had to vacate their classrooms at any one time.

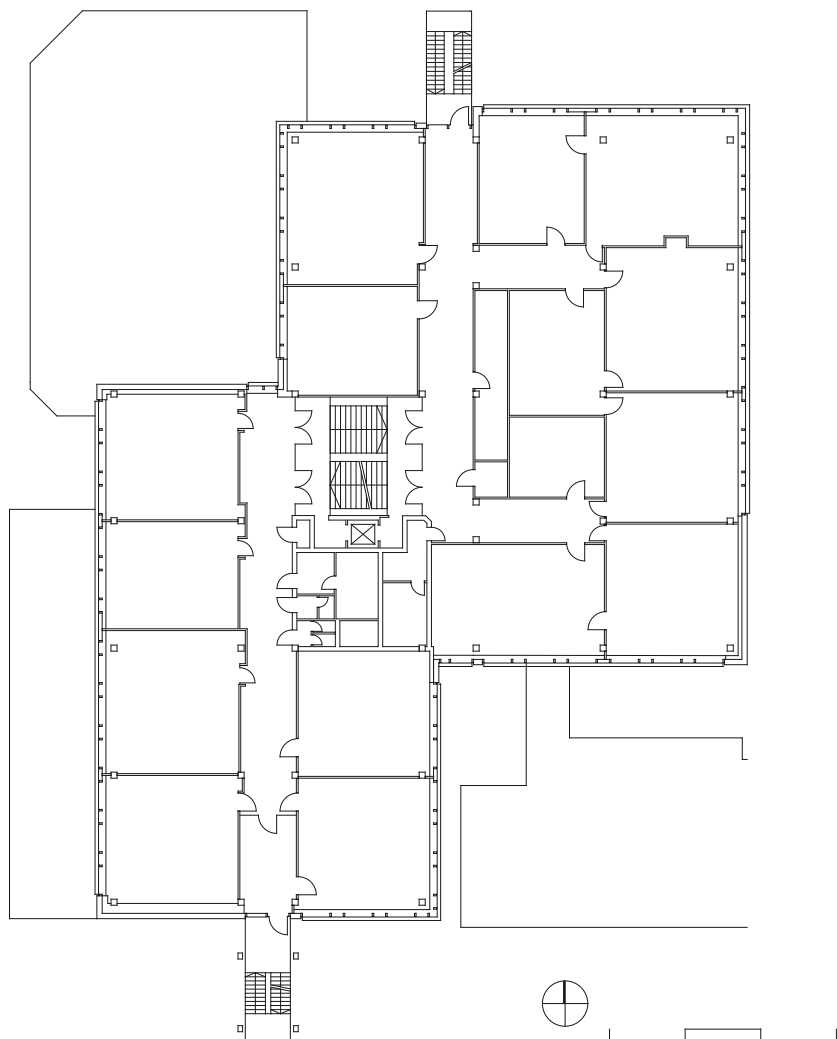
188. 2nd floor plan, M. 1:500

Functional Requirements

The building envelope and services revealed exceptional functional and technical deficits with respect to energy efficiency. Besides the building's poor thermal insulation properties and the leakage, the concrete rescue balconies formed massive heat bridges, were heavily damaged and thus in need of refurbishment. The ventilation system was defective and no longer in service. The heating was done by radiators in the parapet of the windows in combination with an outdated, inefficient furnace. As a result it was decided to renew the entire façade as well as provide highly energy efficient services in a holistic solution.

Planning

A fast and frictionless construction process is fundamentally based on methods of prefabrication. This requires the precise documentation of the existing construction and a higher planning effort in order to ensure the required accuracy of the elements and an uninterrupted mounting process.

The first documentation was done as an overview on the basis of the as-built documentation, supplemented with hand measurements for the purpose of control.

During the detail planning and in co-operation with the researchers of the TU München, all were convinced that the prefabrication required a more precise survey and a three dimensional model of the existing façade. The final survey was tendered together with the façade and the successful bidder had to contract a surveyor to provide a 3D model of the main structure. This was the ideal time for the survey in the project because the primary structure was until this point hidden behind a concrete curtain wall. The structure was only fully explorable after the demolition of the outer shell together with the cantilevering balcony construction.

The renovation process started six weeks before summer holidays. Demolition works started in the late afternoon when school closed and lasted into the night. With the start of the summer holidays the mounting of the façade elements began. The element sizes used were between 8.8 m in length and 3.5 m in height, with a total weight of up to 3 tons for the glazed elements. A mineral wool adaption layer was fixed to the concrete parapet. The elements were lifted in place with a site crane, while their fixation was done from a scaffolding. The mounting cycle was split into façade sections and was combined with the demolition and opening of the façade. Thus all openings were immediately closed afterwards in order to ensure the building's security during the nights and weekends.

Energy Concept

In 2008 the county of Ostallgäu's regional authority set their own climate protection goal to roughly reach the passive house standard for future new and modernised public buildings. With this goal achieved, the school building's high primary energy demand will be reduced to 34 kWh/m²a after modernisation. The future heating energy demand is 16 kWh/m²a according to the simulation with PHPP.

Necessary interventions included:

- Repair of energetic inadequacy (heat bridges).
- Reduction of the heat transmission of walls and windows.
- Improvement of the air-tightness.



189. Before modernisation - concrete balconies



190. Demolition of balconies and old façade



191. Trimming shop

- Use of the solar gains by value of $g \geq 50\%$ of the new glazing.
- The roof had recently been renovated and insulated a short time ago.
- The floor plate could not be insulated; this was the reason the passive house standard could not be attained.

A minimised building services concept was developed and based on a highly efficient ventilation plant with heat recovery unit. Future heating of the classrooms will be done by air heating with heat and moisture recovery from the exhaust air. The attainment of the heating load peak in the early hours before school starts is guaranteed by the re-circulated air operation of the ventilation system. Only the administration area is provided with a static heating unit because of their low internal heat gains. No backup heating system is installed because the cooling of the building (without internal heat gains) is below two degrees over a 24 hour period when the external temperature is minus nineteen degrees centigrade.

Energy Scores:

Effective area: 8903 m²

Annual heat energy demand (planned): $Q/A = 16 \text{ kWh/m}^2\text{a}$

A/V-ratio: 0,32 1/m

Cooling energy demand: 5 W/m²



192. Façades after modernisation



193. Mounting of TES elements

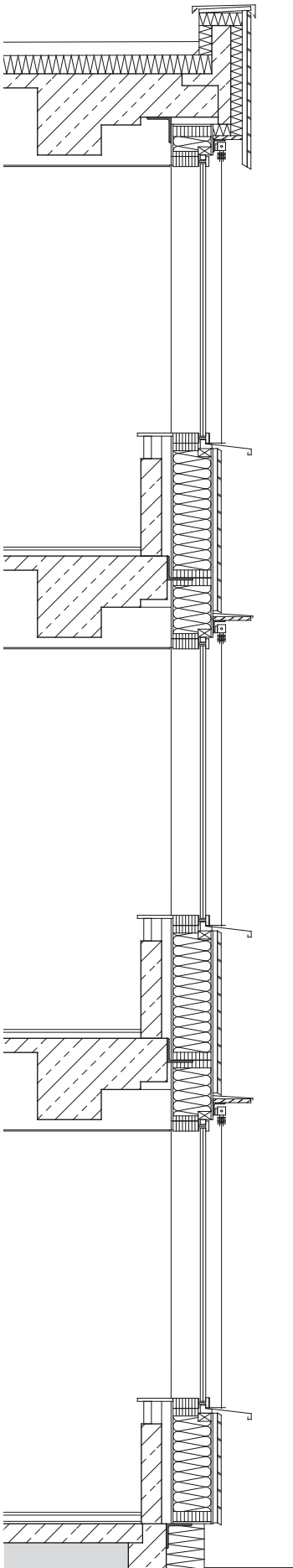

Materials and Construction

The new façade elements are based on a panelled and insulated timber framed construction. The panelling is on both sides and the insulation consists of mineral wool with a density below 50 kg/m^3 and a heat conductivity of 0.035 W/m^2 . The frame is made from laminated timber beams of $6 \times 24 \text{ cm}$ plus a cross-layered frame of $6 \times 6 \text{ cm}$ in order to minimise the heat bridges at the frame. The outer visible skin is clad with horizontal panels of larch with continuous gaps that give a filigree texture to the heavy volumes of the school.

Ecology and User Comfort

In order to avoid pollutants the timber construction material was let well alone and was not impregnated except from the window sills which are coated with clear varnish and the reveals that are impregnated with oil. This was done primarily to reduce operation costs through the better maintainability of the indoor surfaces. The avoidance of chemical treatment of the timber also preserves the ecologic properties in the end-of-life phase.

User comfort is ensured by the ventilation plant. The improvement of the indoor air quality is a must in modernised buildings because the impermeability of the enhanced building skin reduces natural air infiltration. This fact leads to higher concentrations of pollutants like Radon, CO_2 and volatile organic compounds (VOC). A controlled ventilation of classrooms substantially improves the indoor air quality as well as user productivity and well being. The classrooms are naturally illuminated over large and high ribbon windows that helps to save lighting energy. Overheating protection during summer time is facilitated by a manually operated vertical sun shading device.

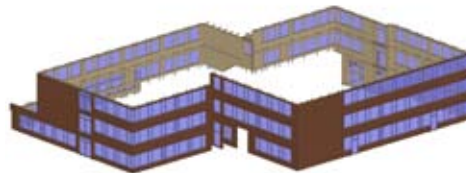

194. CAD/CAM model of elemented façade ready for production.



195. Survey result - 3D wireframe model of the main structure, ceilings and columns.

Parapet:

- Exist. const. 160mm concrete + 40 mm wood wool

- Adaption layer 35 mm mineral wool WLG 035

TES Element from inside to outside:

- OSB panel 15mm
- Timber members BS 11 (GI24h) 80/200 mm
- Rail beam S 10 (C24) 120/200 mm
- Battens S 10 (C24) 60/100 mm horizontal
- 200 + 100 mm mineral wool WLG 035

- Gypsum fibre board 12,5mm

- Façade membrane, diff. open, e.g. Du Pont Tyvek UV (EN 13859-2)

- Battens 40/40 mm

- Horizontal cladding panels, larch, 28/70-150 mm, narrow sides conical bevelled, mounted with 10 mm gap

- Sun shades: larch panel 30 mm mounted on brackets

- Top covering sheet metal

196. Cross section, Façade, M. 1:20



197. Façade edge - fully glazed

Natural ventilation and the contact of the pupils and teachers with the exterior climate and the natural environment is ensured by opening wings in the façade. Considerable attention was paid to the issues of user operation and freedom. Thus individual impressions of comfort should have been significantly improved, and the cliché of the airtight and mechanised passive house with its users held to ransom will be proved wrong.

Statement Architekt A. Müller, e3 Architekten:

„Schule, ein Ort des Lernens, des Lehrens, der positiven Entwicklung und Förderung. Dies alles sind Themen, die nicht nur durch engagierte und positive Lehrkräfte beeinflusst und gesteuert werden, sondern sehr maßgeblich auch durch den Ort / Gebäude selbst, an / in dem Schule passiert.

Die Realschule in Buchloe, in der Hochzeit der Bildungspolitik in den späten 70er Jahren konzipiert und gebaut, macht da keine Ausnahme.

Zum Glück hat dieses Bauwerk jedoch sozialpolitisch und ökologisch engagierte Bauherren, deren Motivation die positive Weiterentwicklung des Schulstandortes ist. Sie forderten im Zuge einer Generalsanierung, die Aktivierung und Optimierung des Gebäudes hin zu einem energieeffizienten und ressourcenschonenden Gebäudegesamt-konzept.“



198. New ventilation system in the suspended ceiling

199. Façade with partially closed sun shades



TES Energy Facade



WoodWisdom-Net

PILOT PROJECT NORWAY

Risør Technical College



Background

Risør videregående skole is a technical college in Risør, a coastal town on the west shore of the Oslo Fjord. In total, the college consists of six individual buildings that contain classrooms, laboratories, workrooms and offices for the administration. The building that is the case study for the TES project was built in the mid-1960s. It has a two-story main building with laboratories and workrooms, and a one-story wing with classrooms.

All secondary schools in Norway are administered by a county government (Norway is divided into 19 administrative counties called “fylke”), with Risør located in Aust-Agder fylke. For the TES project, we were contacted by the head of the building administration of the provincial government who planned to improve the 1960s building at the Risør School because:

- 1) The energy loss was immense due to the rather poorly insulated walls and large window area;
- 2) The large window area no longer served a functional purpose;
- 3) The existing facades, particularly the windows, were in bad condition and very much in need of repair.

Project partners

Together with Trebyggeriet AS, our industry partner in the TES project, we decided that the Risør School would be an appropriate case study. As the TES project is a research project, we did not have to acquire a public bid to secure the construction contract. However, as the new facade required a building permit in accordance with Norwegian building legislation, we needed to have a licensed architect draft the project and present the application for the building permit. For this purpose, the architectural firm of Arkitektstudio AS was contracted by the TES project in order to carry out the architectural drafting and building permit application.

Architectural context

Risør is an historic town in which all the historic buildings from the 18th and 19th centuries are constructed of wood as a log structure, with an outer cladding of wooden boards. Today, the town authorities have adopted a strategy to develop Risør as a modern wooden town, which means that all new structures must be built using wood. As a result of this, the project to refurbish the Risør Technical College with a new wooden facade fit very well with the aim of the authorities.

Project aim

The aim of the project was not to achieve a passive house standard, but instead to dramatically improve the energy performance of the school building. Consequently, the project needed to design and assemble new walls with adequate insulation. In addition, a decision was made to improve the insulation of the roof by blowing mineral wool fiber into the existing timber frame roof structure. The school administration now has a precise account of the energy needs for the existing building, and will closely monitor its energy use in the refurbished building. In the meantime, the TES project will carry out an energy simulation for the refurbished facade, although at the time of this writing this has yet to be completed.



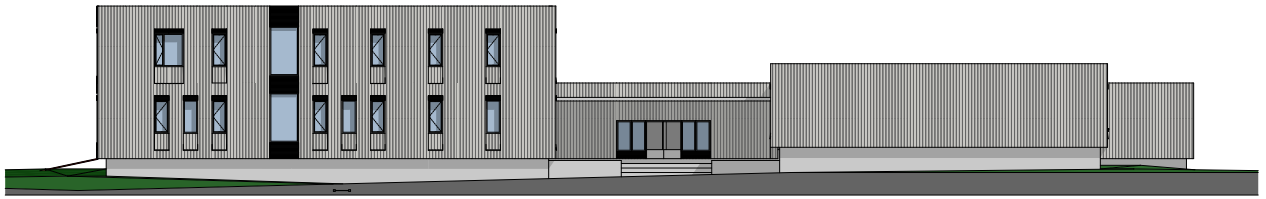

elevation north

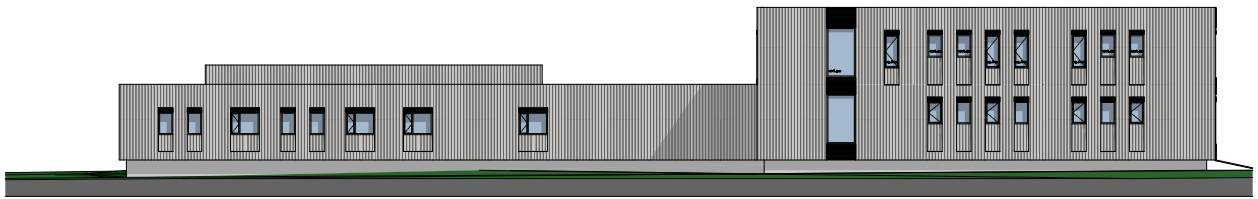

elevation south

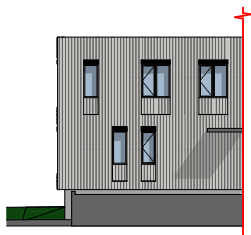
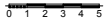

elevation west, workshop



elevation west

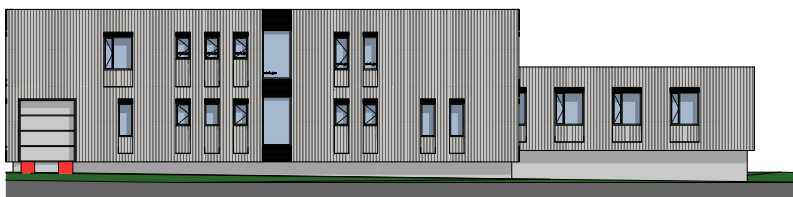

elevation east

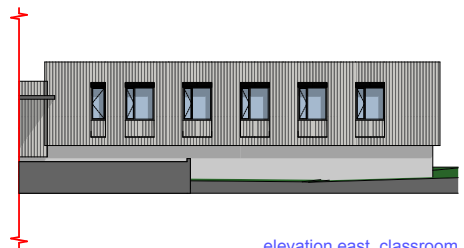

elevation east, classroom

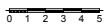

Elevation

TES energy facade - Risør Videregående Skole

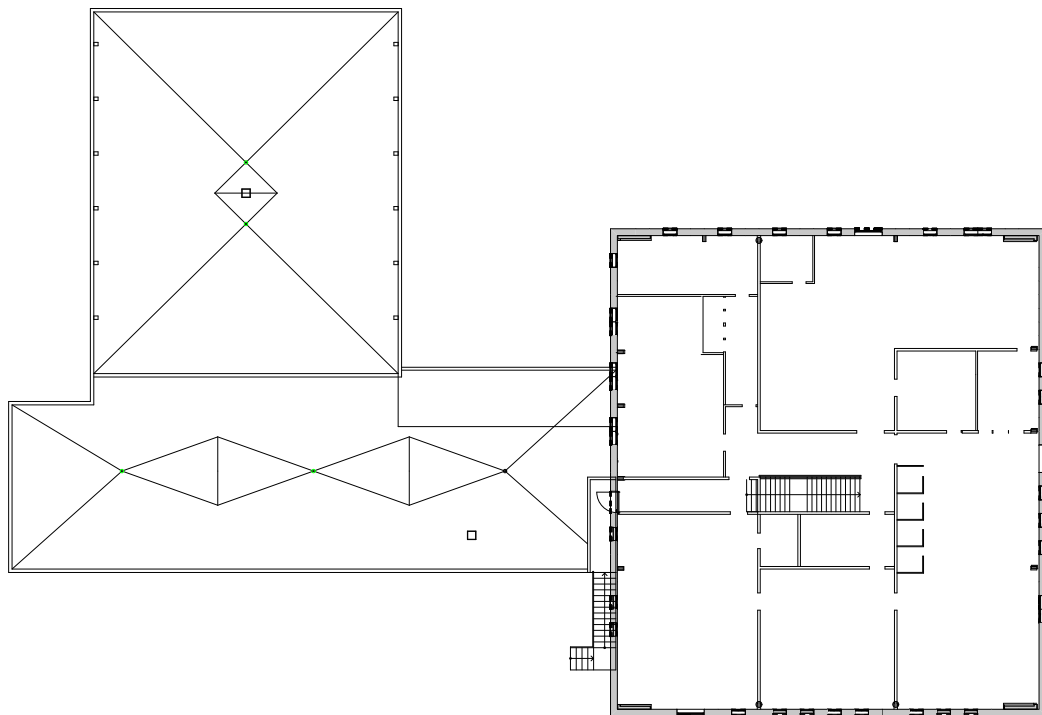
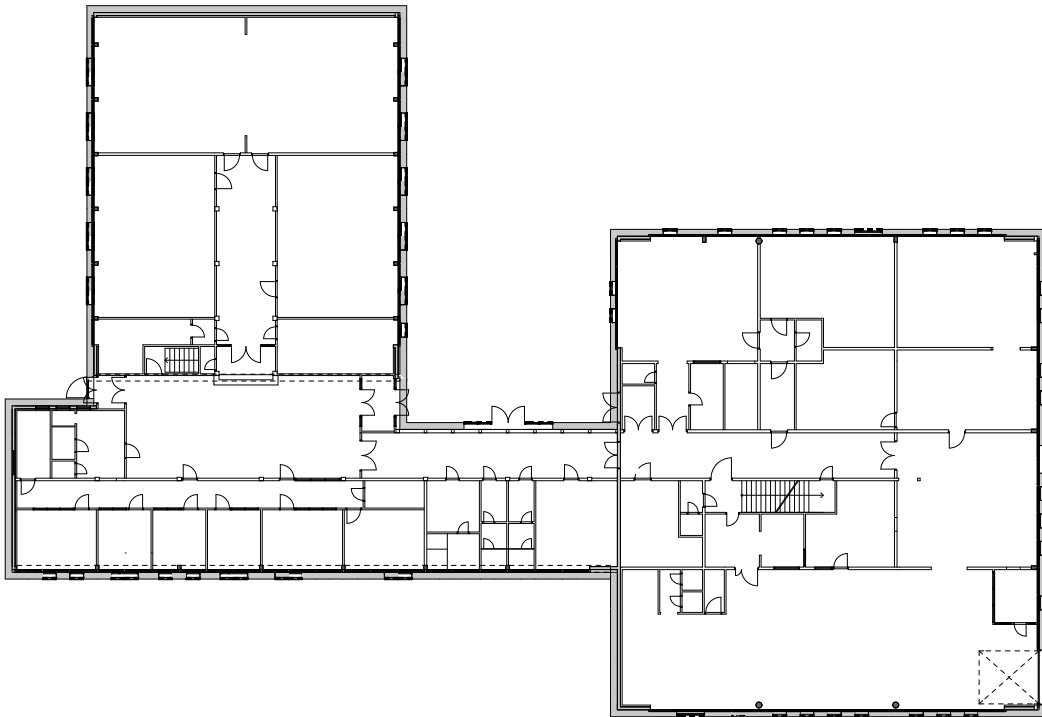

0 1 2 3 4 5

Plan level 2

TES energy facade - Risør Videregående Skole

Existing structure

Both the two-story main building and the one-story wing are constructed of concrete (columns bearing prefabricated floor elements), with the facades made of a two-by-four inch timber frame with mineral wool insulation fixed to the concrete structure. The outer cladding is made of mineral particle board and the inside boards made from various materials. Since the existing materials, including the windows, were in bad condition and the window area was quite large and considered to be inappropriate for the activities in the laboratories and classrooms, it was decided to remove the existing walls completely.

All the existing materials that were dismantled were then recycled.



Documentation

3D laser scanning was used to document the existing structure. However, as the existing walls were going to be removed and the concrete that would serve as the basis for the new elements was visible only at the foundations, it was decided that this approach was not feasible. Instead, the fabricator manually made a detailed measurement of the existing structure in order to secure the proper documentation for the detailed planning of the new elements. It was discovered that the concrete structure was imprecise with deviations of up to 150 mm.

Design development: The interface between architect and fabricator

A draft project using a scale of 1:200 was presented by the architect (Arkitektstudio AS), the client approved the project plan and based on the draft project, the fabricator (Trebyggeriet AS) developed the technical details. In a close dialogue between architect and fabricator, the details were further developed and fine-tuned. The architect exported 3D files in the IFC format to the fabricator which allowed the fabricator to then import the IFC files into the CAD/CAM software (CADWORK). To optimize this process however, both sides felt that further experimentation was necessary. Due to time constraints and the fact that the fabricator wished to build the model from scratch using the CAD/CAM software, it was decided that for practical reasons, it was more convenient to export 2D DWG files and sketches in PDF from the architect to the fabricator in order to speed up the process. Based on the architect's digital documentation, the fabricator built a separate model in CADWORK. The fabricator worked in parallel with two screens, one containing the architect's model and the other the fabrication model. Data was extracted from the architect's model and brought into the fabrication model. The reason for this is that the fabricator feels that in order to have a complete understanding of the project, it is necessary for them to build their own digital model. In their opinion, this is the only way to ensure the technical quality of the project based on their detailed knowledge of the structure.

The architect varied the facade by slightly tilting the boarding under the windows. Moreover, it was decided to have cladding boards of varying width in order to make the appearance of the building more interesting. Boards with a width of 98, 123, and 148 mm were used.



The elements



The new walls are constructed as a timber structure with an outer cladding of 21 mm thick spruce boards (*Picea abies*) and an inner cladding of 22 mm OSB plates. The outer cladding is treated with a mineral paint from the German company Keimfarben (Keim Soldalit mixed with Keim Soldalit fixative 1:1), and the total thickness of the wall is 500 mm.

The basic element consists of two parts:



- 1) An inner part with the OSB plate fixed to a 96 mm thick timber frame filled with mineral wool insulation. During assembly, this inner element was first put into place between the concrete floor and ceiling, and fixed with Heco concrete screws.
- 2) The outer element has a 198 mm thick timber frame that was filled with wood fiber insulation and then assembled. The outer element has a 12 mm OSB plate on the inside, and on the outside an 18 mm impregnated wood fiber plate, 48 mm vertical slats for ventilation and 48 mm horizontal slats fixed to these which serve as the basis for the external vertical boards. The outer elements rest on steel brackets fixed to the concrete foundations and are connected to the inner elements with screws; between the two elements there is a "tolerance gap" filled with mineral wool insulation.

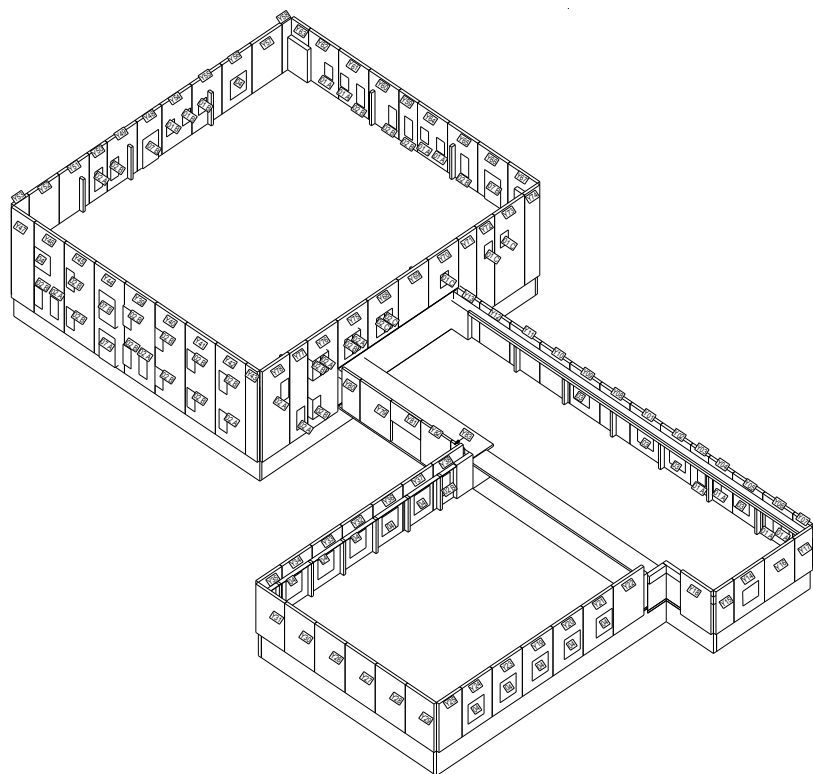

X-section Vertical

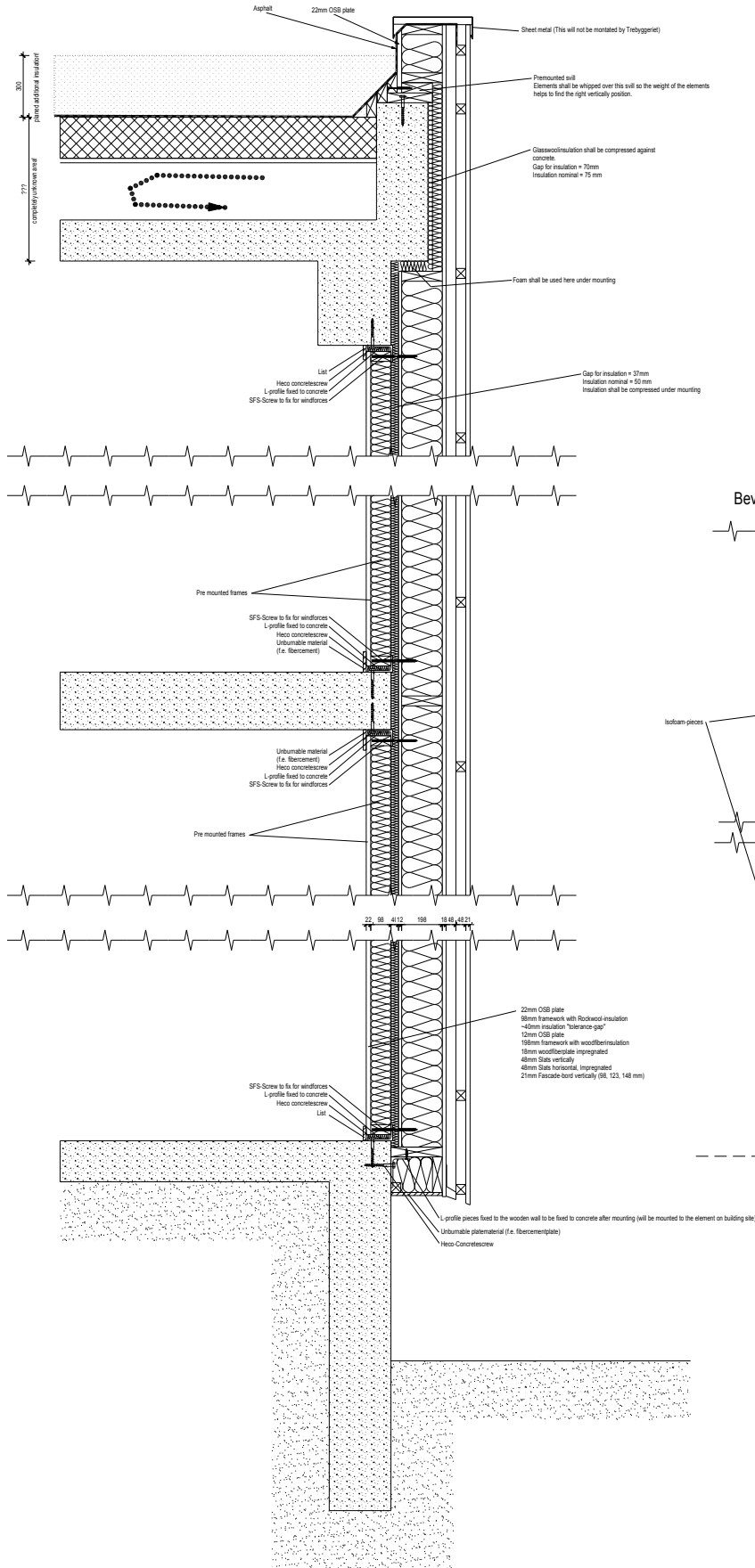

Window details vertical

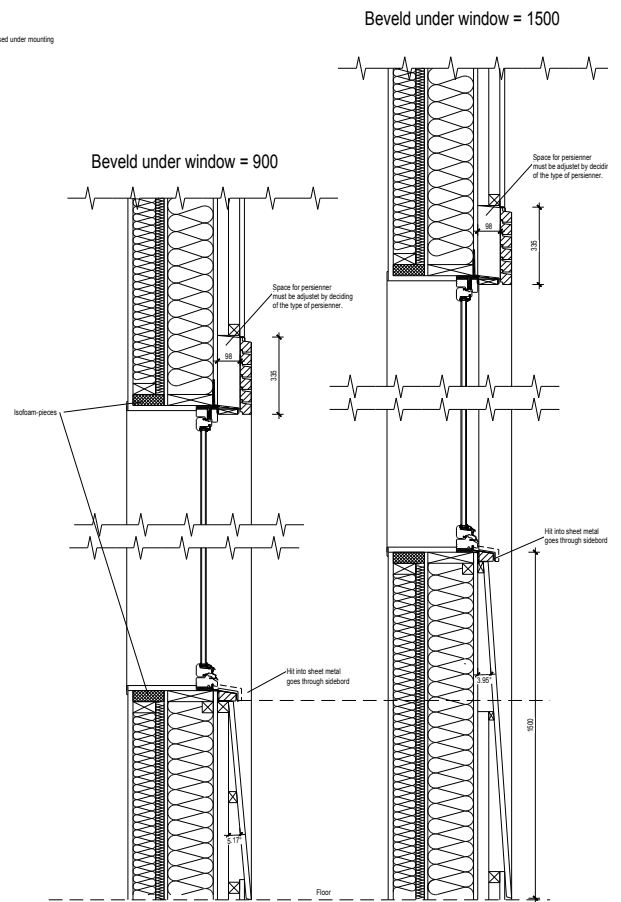

Indeksnr	Hvem	Dato	Endring
01	HEA	02.01.2008	Lagring av arbeidsdetaljer
Prosjekt: P399 Risør VGS Fassadesanering Kunde: Aust -Agder Fylkeskommune Tegningsnavn: Prinsippnitt gjennom fasade Tegning: P399 Rise: Detalje REV 1.24 Dato: 06.10.2008 Forfatter: MAA Godkjent: MAA Tegningsnummer: 1 av 2 Skala: M 1:10			
Trebyggeriet AS Kjøp 4337 HORNES Telefon: 37627125 Faks: 37627131 www.trebyggeriet.no			

Fabrication

The elements were fabricated in the controlled environment of the Trebyggeriet Company, which is approximately two hours by car from Risør. The element left the factory complete with windows mounted, external cladding pre-treated with mineral paint, and wrapped in plastic foil and transported by truck to the site, where the truck's crane was used to assemble the elements.



Assembly

The existing walls were dismantled room by room and the new elements subsequently mounted. The entire process was extremely smooth, leading to only a minor disruption of the school's daily activities. The students had to leave for 24 hours and were back in the classroom the following day.

Due to the large variations in the accuracy of the existing concrete structure, the corner details where the two elements meet were designed by the fabricator in order to account for possible variations in the geometry of the concrete.



Acknowledgements

We are grateful that the Aust-Agder provincial government administration and Mr. Kjell Jensen agreed to cooperate with the TES project. We are also grateful for the enthusiastic support the project has had from the Risør School administration and the Headmaster, Mr. Ole Konrad Gravningsmyr.

We wish to thank Trebyggeriet AS, the industry partner of the TES project and the CEO, Mr. Sigbjørn Daasvatn. We also wish to thank Arkitektstudio AS for their enthusiastic input in helping to develop a fully functional and aesthetically pleasing new facade for the Risør Technical College.



Prof. Dr. Techn. Knut Einar Larsen

NTNU

Faculty of Architecture and Fine Art,

Department of Architectural Design, History and Technology.

N-7491 TRONDHEIM

knut.e.larsen@ntnu.no



Further Information about the TES_PROJECT can be downloaded at <http://www.tesenergyfacade.com>



6.3. Student Housing, Oulu, Finland

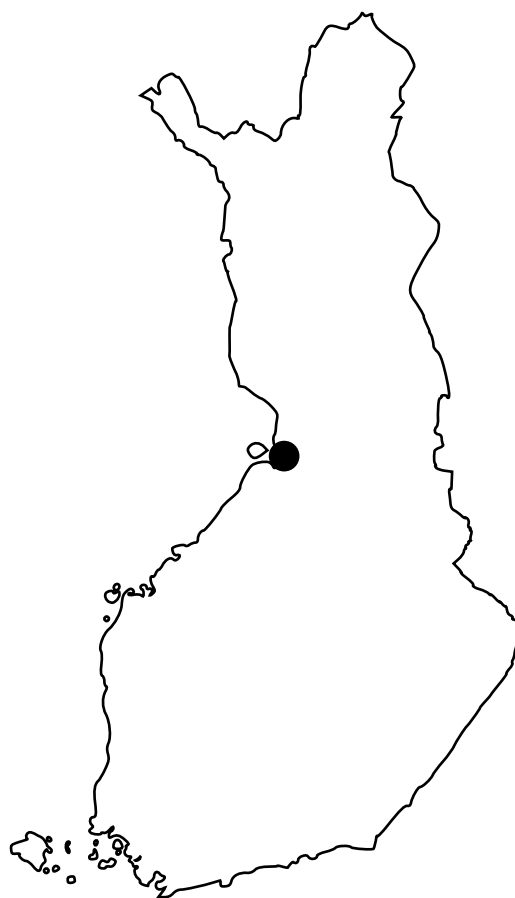



Situation plan. Image Juha Lehto.

Below: The Finnish pilot is a high rise, student housing building situated in northern Finland.

Image Kimmo Lylykangas.

PROJECT Student housing, Pohjankaleva Oulu, Finland
 OWNER PSOAS Pohjois-Suomen opiskelija-asuntosäätiö
 LOCATION Tirolintie 2, Oulu,
 Finland
 ARCHITECT arch.student Juha Lehto, master thesis
 (presented here)
 final planning by Ave Forma Oy

YEAR OF CONSTRUCTION 1970
 YEAR OF MODERNISATION Construction works start in 2010
 TYPE Student housing
 FLOOR AREA NET 3568 m2 floor area
 VOLUME
 SURFACE 2000 m2 exterior walls
 UNITS 1
 STOREYS 9



Section to the north. The design suggests an additional floor on top of the building.

Top next page: Suggested elementation of building gables with vertical TES elements.

Images Juha Lehto.

Bottom next page: Detail of existing facade consisting mainly of facade elements of 300 mm thick Siporex.

Image Yrsa Cronjort.

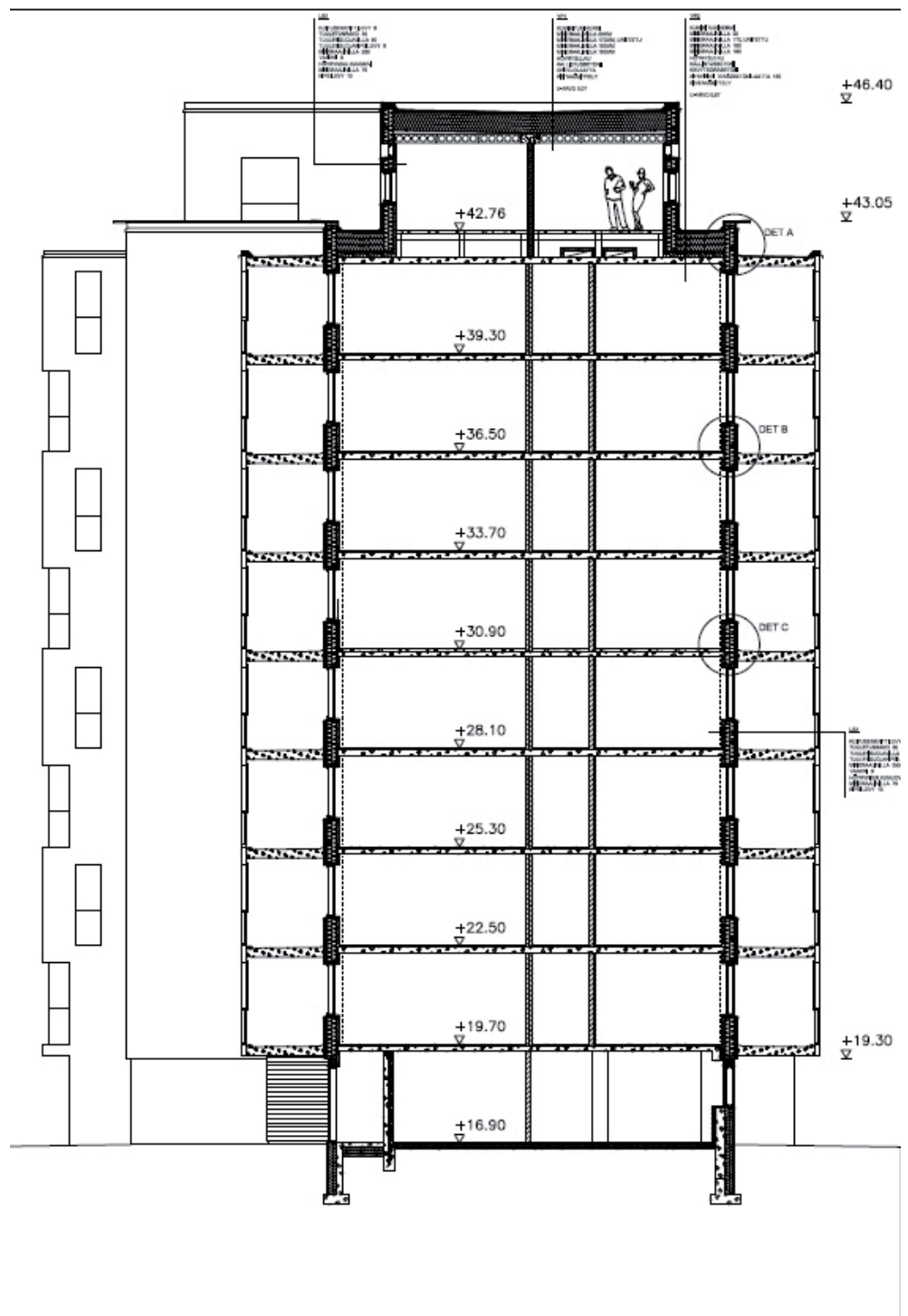

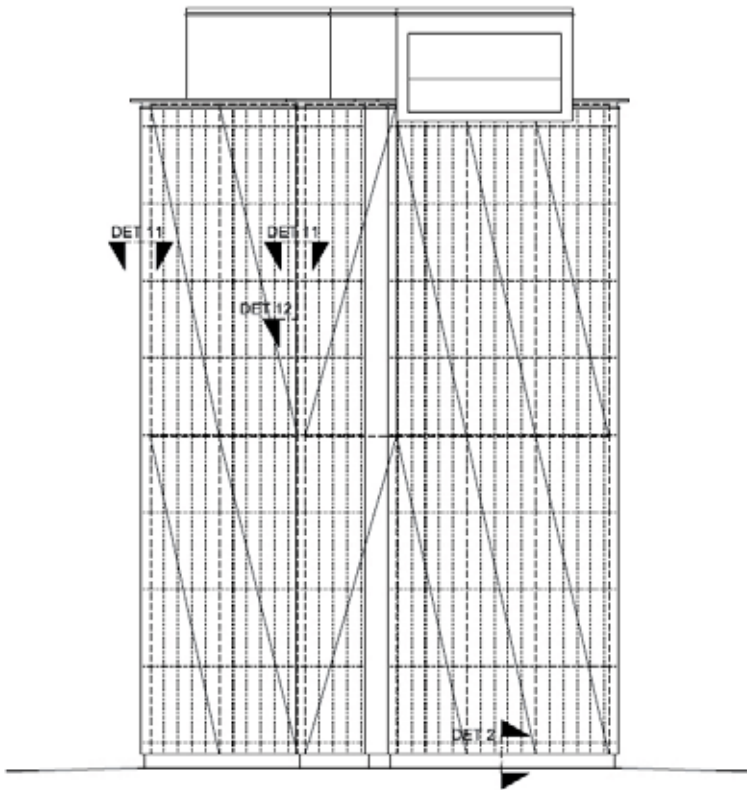

EXISTING STRUCTURE / BUILDING PROPERTIES

The original structure is based on a load bearing bookshelf frame in concrete with facades in non load bearing Siporex elements with a structural thickness of 300mm. The end gables consist of a load bearing wall in 160mm concrete covered with Siporex elements, thickness 300 mm. The master thesis design suggests the complete removal of existing façade elements and replacement with new TES elements.

Existing wall structure

Siporex elements

partly wood framed exterior wall details covered with glass

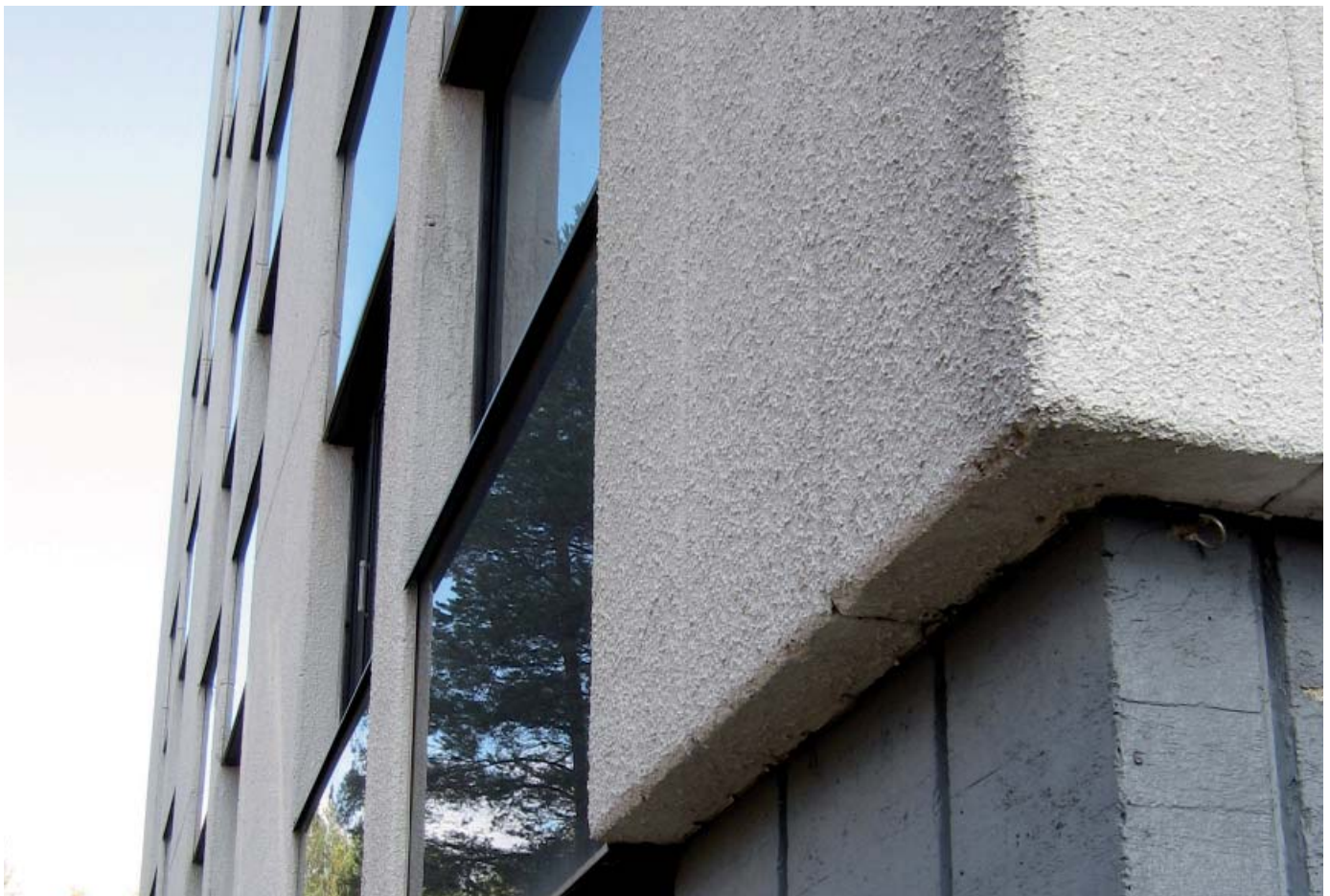

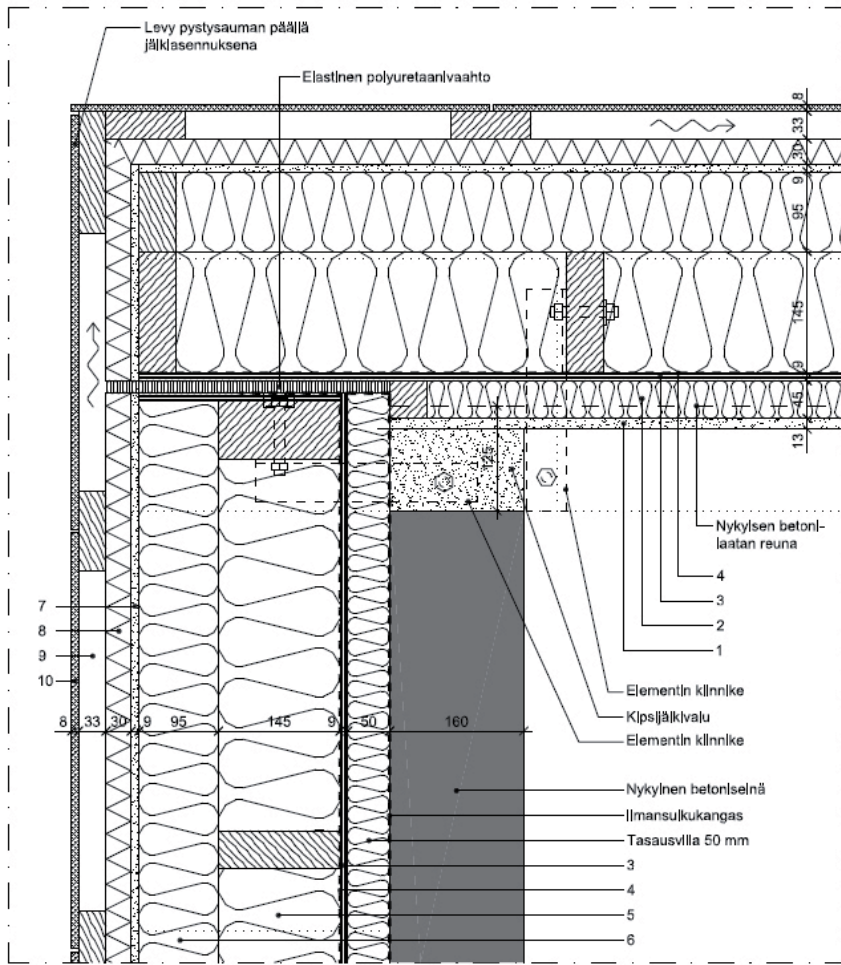

DET 11

TES ELEMENT

U-value: 0,14 w/m²K

- 13mm gypsum board
- 45mm post + mineral wool
- 9 mm plywood
- vapour barrier

- 145 mm post vertical + mineral wool
- 95 mm post horizontal + mineral wool
- 9 mm wind barrier gypsum board
- 30 mm wind barrier mineral wool
- 33 mm ventilation gap
- 8 mm fibre cement board

FIRE SAFETY

- frame capsuled with gypsum board
- insulation non-combustible
- storeywise, horizontal fire seals in profiled sheet metal

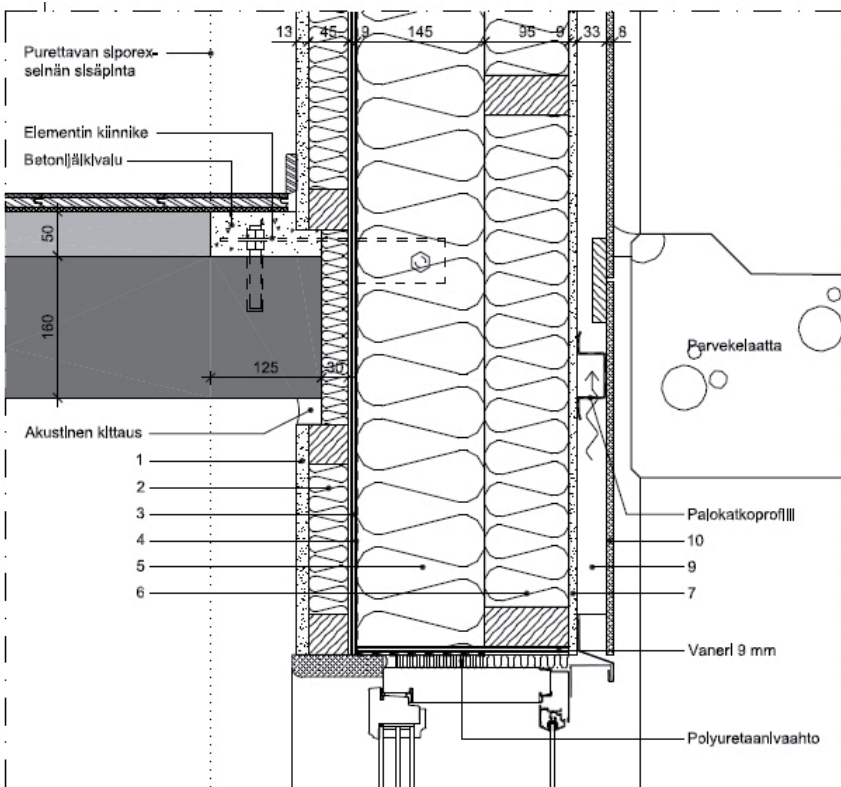

DET 6

Top: Horizontal corner detail.

Below: Vertical detail of intermediate floor and window joints.

Top next page: Suggestion for elementation of the building with vertical TES elements.

Images Juha Lehto.

U-values W/m²K

	before	after (targets)
Wall	0,48	0,14
Roof	0,28	0,07
Window	1,8	0,8

Energy demand kWh/m²a

PEI	220,70	70,9 (target)
HED	165	30 (target)

TPED total primary energy demand

HED heat energy demand



OBJECTIVES

The Oulu Pohjankaleva pilot is situated in northern Finland and most northern parts of Europe. The building is also a high rise building, increasing the challenges of an energy efficient retrofitting. These challenges have been studied by architectural and structural means, building physics testing, fire safety analysis and fire safety engineering and dynamic energy simulation aiming at the optimization of building performance as to reach the target of passive house level energy efficiency.

The primary energy efficiency target was set at an heating energy demand of maximum 30 kWh/gross m²,a and primary energy demand of 130 - 140 kWh/m²,a, the improvement of air tightness to $n_{50} \leq 0,6$ 1/h. Energy simulations show that even with u-values of 0,24 W/m²K for exterior walls and 0,08 W/m²K for roof a heating energy demand of less than 25 kWh/gross m²,a can be reached. A prerequisite is a ventilation unit with a yearly heat recovery rate of 85%. With these values a primary energy demand of less than 90 kWh/m²,a can be reached (used primary energy coefficients 0,5 for district heating and 2,5 for electricity).

The results show that the passive house level is possible to reach in the renovation of an existing building even in northern Finland. This requires interactive design including energy simulation of chosen solutions as to reach energy efficiency goals of the renovation.

Testing the results of photogrammetry modelling with architectural 3D model. Image Juha Lehto.

Below: Dynamic energy simulation requires the creation of an IFC model, possibly required as a modelling result of laser scanning.



SURVEYS, SIMULATIONS CARRIED OUT

survey photogrammetry
 survey tachymetry measurement report
 survey building condition report
 survey heat- and moisture measurement report
 survey thermographic camera scan report
 design work started, workshop
 dynamic energy simulation

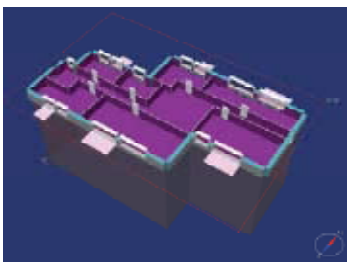

RESULTS OF ENERGY SIMULATIONS

passive house level of energy efficiency is possible to reach in the modernization of existing building stock in the Finnish climate

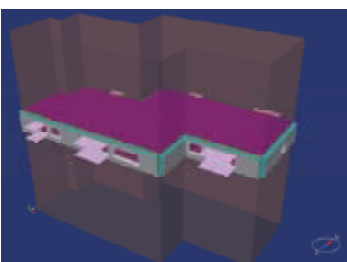

Order of importance of measures:

- renewed ventilation with high rate of heat recovery
- renewed windows
- additional thermal insulation

