

# Isolation and Reactivity of Stannyleneoids Stabilized by Amido/Imino Ligands

Xuan-Xuan Zhao,<sup>[a]</sup> Shiori Fujimori,<sup>[a]</sup> John A. Kelly,<sup>[a]</sup> and Shigeyoshi Inoue\*<sup>[a]</sup>

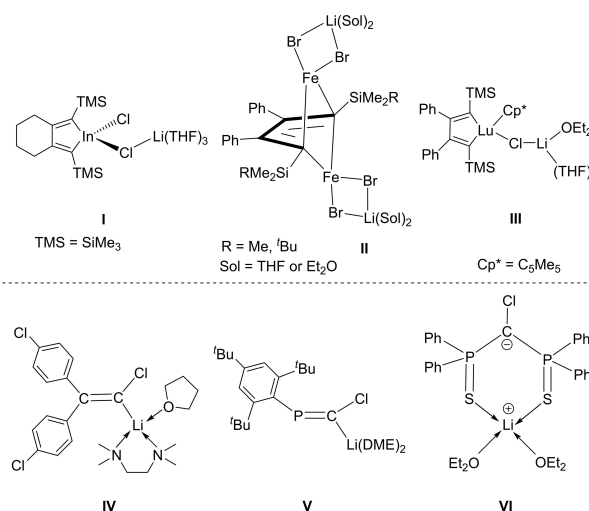
**Abstract:** The reaction of the lithium aryl(silyl)amide  $\text{Dipp}(\text{Pr}_3\text{Si})\text{NLi}$  ( $\text{Dipp} = 2,6\text{-}i\text{-Pr}_2\text{C}_6\text{H}_3$ ) with one equivalent of  $\text{SnCl}_2$  in THF gave a novel stannyleneoid  $\text{Dipp}(\text{Pr}_3\text{Si})\text{NSnCl}\cdot\text{LiCl}(\text{THF})_2$ . Heating the solution of amidostannyleneoid in toluene to  $80^\circ\text{C}$  resulted in dimeric amido(chloro)stannylene  $[\text{Dipp}(\text{Pr}_3\text{Si})\text{NSnCl}]_2$ , which can be converted to bis(amido)stannylene  $\text{Sn}[\text{N}(\text{Dipp})\text{Pr}_3\text{Si}]_2$  and

amido(imino)stannylene  $\text{Sn}[\text{N}(\text{Dipp})(\text{Pr}_3\text{Si})][\text{IPrN}]$  ( $\text{IPrN} = \text{bis}(2,6\text{-diisopropylphenyl})\text{imidazolin-2-imino}$ ). Treatment of bis(imino)stannyleneoid  $[\text{IPrN}]_2\text{Sn}(\text{Cl})\text{Li}$  with  $\text{N}_2\text{O}$  resulted in the dimeric complex  $[\text{IPrNSn}(\text{Cl})\text{OLi}]_2$ . All compounds were characterized by NMR, elementary analysis, and X-ray structural determination.

## Introduction

$\text{MX}$ -functionalized complexes ( $\text{M} = \text{alkali metal}$ ,  $\text{X} = \text{leaving group}$ ) are commonly observed in organometallic chemistry.<sup>[1]</sup> For example, Xi and coworkers reported the metallacycle of indium bearing a  $\text{Cl}\text{-Li}(\text{THF})_3$  moiety (**I**, Figure 1).<sup>[2]</sup> Subsequently, they synthesized the nonplanar metalla-aromatics complexes (**II**) with two iron centers coordinated by four bromides.<sup>[3]</sup> They also reported the lutetacyclopentadiene- $\text{LiCl}$  complex (**III**).<sup>[4]</sup> Moreover, the Luo group also described some rare-earth-metal- $\text{LiCl}$  complexes, which are thermally stable at ambient temperature.<sup>[5]</sup> In contrast,  $\text{E-MX}$  complexes ( $\text{E} = \text{group 14 element}$ ) are relatively unstable and less explored.

Carbenoids with the formula  $\text{R}_2\text{CMX}$  ( $\text{M} = \text{alkali metal}$ ,  $\text{X} = \text{leaving group}$ ) have attracted much attention owing to their unusual reactivity.<sup>[6]</sup> In recent years, there have been important developments in the search for stable  $\text{LiCl}$  carbenoid species. In 1993, Boche and coworkers reported on the isolation of a  $\text{LiCl}$  alkylidene carbenoid (**IV**),<sup>[7]</sup> which was stable up to  $-60^\circ\text{C}$  (Figure 1, bottom). Two years later, Niecke and coworkers synthesized the phosphavinylidene carbenoid (**V**) containing a  $\text{P}(\text{III})$  atom,<sup>[8]</sup> which decomposed on warming to room temperature. In 2007, Le Floch and coworkers isolated the first example of the room temperature stable carbenoid (**VI**) by the chlorina-



**Figure 1.**  $\text{MX}$ -functionalized complexes ( $\text{M} = \text{alkali metal}$ ,  $\text{X} = \text{leaving group}$ ) (top) and selected examples of carbenoids (bottom).

tion of the corresponding dianion by mild oxidation of stable geminal dianions.<sup>[9]</sup>

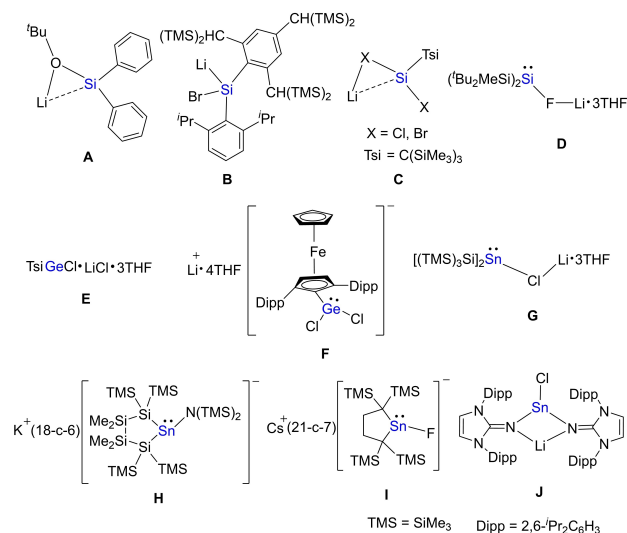
Like carbenoids, the isolation of heavier congeners ( $\text{R}_2\text{EMX}$ ;  $\text{E} = \text{Si, Ge, Sn, Pb}$ ;  $\text{M} = \text{alkali metal}$ ,  $\text{X} = \text{leaving group}$ ), is also largely underexplored. For example, in 1997, Tamao and coworkers investigated the alkoxy-substituted silylenoid  $(t\text{-BuO})\text{Ph}_2\text{SiLi}$  (**A**) (Figure 2),<sup>[10]</sup> which underwent bimolecular self-condensation at  $0^\circ\text{C}$ . Within the same year, the silylenoid  $\text{Tbt}(\text{Dipp})\text{Si}\cdot\text{LiBr}$  (**B**) ( $\text{Tbt} = 2,4,6\text{-}[\text{CH}(\text{SiMe}_3)_2]_3\text{C}_6\text{H}_2$ ;  $\text{Dipp} = 2,6\text{-}i\text{-Pr}_2\text{C}_6\text{H}_3$ ) was synthesized by the reduction of dibromosilane with lithium naphthalene.<sup>[11]</sup> Moreover, Lee and coworkers have widely investigated the reactivity of metal/halogen silylenoids **C**.<sup>[12]</sup> It should be noted that the first structurally characterized silylenoid **D** was reported in 2006.<sup>[13]</sup>

Up to now, the germanium and tin congeners remain largely unexplored mainly due to the increased stability of the divalent  $\text{Ge}(\text{II})$  and  $\text{Sn}(\text{II})$  oxidation state in comparison to the

[a] Dr. X.-X. Zhao, Dr. S. Fujimori, Dr. J. A. Kelly, Prof. Dr. S. Inoue  
School of Natural Sciences, Department of Chemistry  
WACKER-Institute of Silicon Chemistry and Catalysis Research Center  
Technische Universität München  
Lichtenbergstraße 4, 85748 Garching bei München (Germany)  
E-mail: s.inoue@tum.de

Supporting information for this article is available on the WWW under  
<https://doi.org/10.1002/chem.202202712>

© 2022 The Authors. Chemistry - A European Journal published by Wiley-VCH GmbH. This is an open access article under the terms of the Creative Commons Attribution Non-Commercial License, which permits use, distribution and reproduction in any medium, provided the original work is properly cited and is not used for commercial purposes.



**Figure 2.** Literature known examples of heavy tetraylenoids (18-c-6 = 18-crown-6 ether; 21-c-7 = dibenzo-21-crown-7 ether).

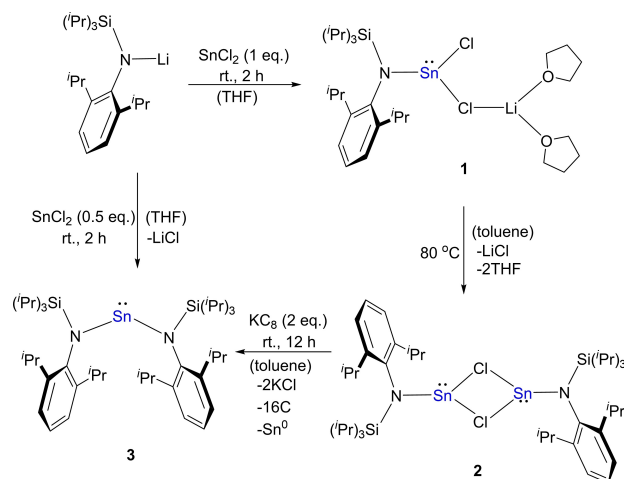
lighter congeners. As a consequence, the elimination of metal halide (MX, M = alkali metal, X = leaving group) from the high-coordinate germanium or tin center is strongly favored. In 1996, Ando and Ohtaki described the synthesis of a trisilyl-substituted chlorogermyleneid **E**,<sup>[14]</sup> however, the molecular structure of this compound in the solid state was not reported (Figure 2). In 2016, Sasamori and coworkers successfully synthesized the chlorogermyleneid **F** that was studied by X-ray crystallography.<sup>[15]</sup>

As for the stannyleneids, in 1987, Cowley and coworkers reported the silyl-substituted stannyleneid **G**.<sup>[16]</sup> Notably, efforts to remove the solvated LiCl from **G** were unsuccessful, sublimation or prolonged refluxing in toluene resulted in decomposition. With the help of crown ethers, the stannyleneids **H**<sup>[17]</sup> and **I**<sup>[18]</sup> were isolated and characterized by X-ray crystallography. In 2016, we reported a rare example of a lithium stannyleneid **J** prepared by using the N-heterocyclic imine (NHI) ligand and verified the high stannyleneid character of this compound by demonstrating its ambiphilic reactivity.<sup>[19]</sup> More recently, Wesemann and coworkers described the complex [TbbSnBr<sub>2</sub>][Li(THF)<sub>2</sub>] (Tbb = 2,6-[CH(SiMe<sub>3</sub>)<sub>2</sub>]<sub>2</sub>-4-<sup>t</sup>BuC<sub>6</sub>H<sub>2</sub>) containing a four-membered LiBr<sub>2</sub>Sn ring.<sup>[20]</sup>

Motivated by the above results, we report on a room temperature stable stannyleneid by using a bulky amido ligand. We also show its facile transformations into the corresponding amidostannyleneids. Moreover, we investigated further reactivity of bis(imino)stannyleneid **J** towards N<sub>2</sub>O.

## Results and Discussion

The reaction of Dipp(<sup>i</sup>Pr<sub>3</sub>Si)NLI with one equivalent of SnCl<sub>2</sub> in THF at room temperature led to the formation of the amidostannyleneid **1** in high yield (83%; Scheme 1). No elimination of LiCl was observed in C<sub>6</sub>D<sub>6</sub> at room temperature



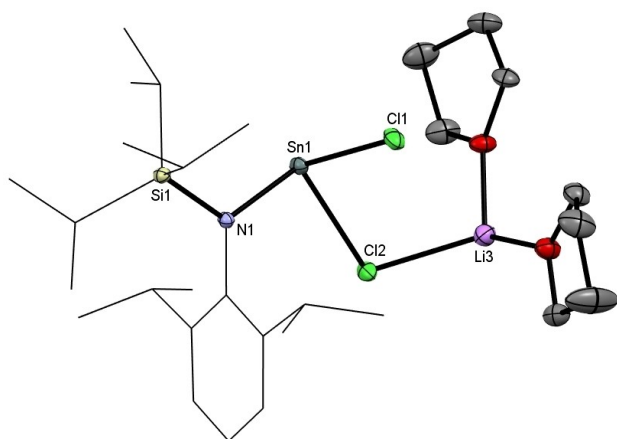
**Scheme 1.** Synthesis of amido-substituted stannyleneid **1** and its facile transformation into the dimeric amido(chloro)stannylene **2**, as well as the synthesis of bis(amido)stannylene **3**.

for at least one week. Compound **1** was characterized by multinuclear NMR spectroscopy and elemental analysis (see Supporting Information for more details). The <sup>29</sup>Si{<sup>1</sup>H} NMR spectrum of **1** displays a signal at 7.8 ppm in C<sub>6</sub>D<sub>6</sub>, which is downfield shifted in comparison to Dipp(<sup>i</sup>Pr<sub>3</sub>Si)NLI (−5.6 ppm, C<sub>6</sub>D<sub>6</sub>). The signals of the Dipp group in the <sup>1</sup>H NMR spectrum of **1** are also shifted to lower field than those of Dipp(<sup>i</sup>Pr<sub>3</sub>Si)NLI, indicating strong electron-donation from the amido ligand to the tin center. The <sup>119</sup>Sn{<sup>1</sup>H} NMR spectrum shows a signal at 197.7 ppm, which is downfield shifted in comparison to **J** [−52.1 ppm, C<sub>6</sub>D<sub>6</sub>], indicating a more electron-poor Sn(II) center.

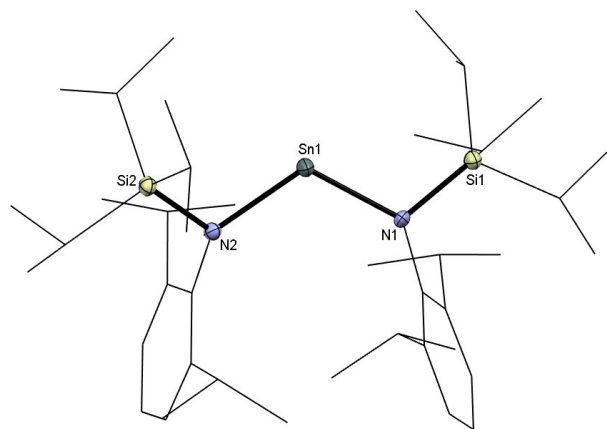
Colorless crystals of complex **1** suitable for X-ray diffraction (XRD) were grown from *n*-pentane at −30 °C. It crystallizes in the space group *P*2<sub>1</sub>/*c*. The molecular structure is shown in Figure 3. Compound **1** contains one equivalent of Cl–Li(THF)<sub>2</sub> moiety. In **1**, the tin center is coordinated by one chlorine atom, one amido ligand, and one Cl–Li(THF)<sub>2</sub> moiety to form a triangular pyramid geometry (sum of angles at Sn is 285.86°). The bond distance for Sn–N1 is 2.115(1) Å, which is longer than those in Lappert's stannylene Sn[N(SiMe<sub>3</sub>)<sub>2</sub>]<sub>2</sub> [2.09(1) Å].<sup>[21]</sup> The bond length for Sn–Cl1 [2.5679(6) Å] is longer than that of Sn–Cl2 [2.5077(5) Å], indicating a stronger interaction between Sn1 and Cl2. The amido(chloro) tin moiety is linked with Li<sup>+</sup>(THF)<sub>2</sub> moiety by a chlorine atom. The wide bond angle of Sn1–Cl2–Li3 [107.82(7)°] may reduce the steric repulsion between the amido(chloro) tin moiety and Li<sup>+</sup>(THF)<sub>2</sub> moiety.

Due to the efficient stabilization by two bulky and strongly  $\pi$ -donating NHI substituents, the lithium stannyleneid **J** has a high thermal stability in C<sub>6</sub>D<sub>6</sub> at 80 °C, with no elimination of LiCl observed in <sup>1</sup>H NMR. The reactivity of **J** was well investigated, revealing that it undergoes oxidative addition of I<sub>2</sub> and CH<sub>3</sub>I, with the elimination of LiCl from the tin center.

By contrast, heating up a toluene solution of **1** at 80 °C for 2 h readily yields the dimeric amido(chloro)stannylene **2** in 93% yield. Compound **2** was recently synthesized by Hadlington



**Figure 3.** Molecular structure of **1**. Thermal ellipsoids are shown at 50% probability level. Hydrogen atoms are omitted for clarity. Selected bond lengths [Å] and angles [°]: Sn1–Cl1 2.5679(6), Sn1–Cl2 2.5077(5), Sn1–N1 2.115(1), Si1–N1 1.752(1), Cl2–Li3 2.410(3), Cl1–Sn1–Cl2 88.96(2), Cl1–Sn1–N1 100.81(4), Cl2–Sn1–N1 96.09(4), Sn1–N1–Si1 121.20(7), Sn1–Cl2–Li3 107.82(7).



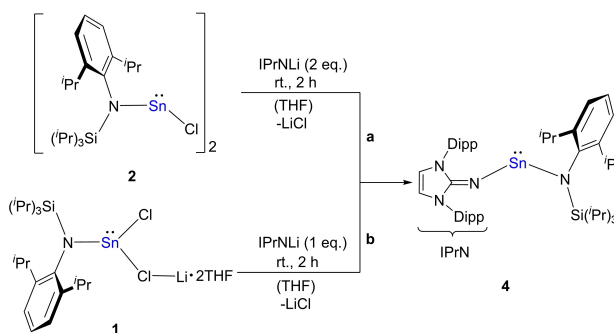
**Figure 4.** Molecular structure of **3**. Thermal ellipsoids are shown at 50% probability level. Hydrogen atoms are omitted for clarity. Selected bond lengths [Å] and angles [°]: Sn1–N1 2.091(7), Sn1–N2 2.124(8), N1–Si1 1.784(9), N2–Si2 1.780(8), N1–Sn1–N2 118.3(3), Sn1–N1–Si1 114.0(4), Sn1–N2–Si2 111.3(4).

*et al.*<sup>[22]</sup> and all characterization matched to what was reported (see the Supporting Information for more details). The  $^{119}\text{Sn}\{^1\text{H}\}$  NMR spectrum shows a signal at 201.5 ppm ( $\text{C}_6\text{D}_6$ ), which is comparable to **1** (197.7 ppm,  $\text{C}_6\text{D}_6$ ), but shifted to high field in comparison to Power's chlorostannylene  $[\text{ArSnCl}]_2$  ( $\text{Ar} = 2,6\text{-bis}(2,4,6\text{-trimethylphenyl})\text{phenyl}$ ) [562 ppm,  $\text{C}_6\text{D}_6$ ]<sup>[23]</sup> indicating a more electron-rich Sn(II) center. In addition, the high number of signals of the Dipp groups in the  $^1\text{H}$  NMR spectrum of **2** reflects its less symmetric structure than **1** in solution ( $\text{C}_6\text{D}_6$ ).

Next we attempted to form reactive, low-oxidation state Sn compounds through reduction utilizing **2**. Treatment of **2** with two equivalents of potassium graphite ( $\text{KC}_8$ ) in toluene at room temperature, resulted in the formation of bis(amido)stannylene **3** (Scheme 1). The orange-red solid was characterized by multinuclear NMR spectroscopy, LIFDI-MS measurements, and elemental analysis (see the Supporting Information for more details). The  $^{119}\text{Sn}\{^1\text{H}\}$  NMR spectrum of **3** in  $\text{C}_6\text{D}_6$  shows a signal at  $\sigma = 517.5$  ppm that is shifted to higher field as compared to that of Power's stannylene  $\text{Ar}_2\text{Sn}$  ( $\text{Ar} = 2,6\text{-bis}(2,4,6\text{-trimethylphenyl})\text{phenyl}$ ) [635 ppm,  $\text{C}_6\text{D}_6$ ]<sup>[23]</sup> and Rivard's stannylene ( $^{\text{Me}}\text{IPr}=\text{CH})_2\text{Sn}$  ( $^{\text{Me}}\text{IPr}=(\text{MeCNDipp})_2\text{C}$ ): [1162 ppm, toluene- $d_6$ ]<sup>[24]</sup> It was also possible to form **3** by the reaction of  $\text{Dipp}(\text{IPr}_3\text{Si})\text{NLI}$  with  $\text{SnCl}_2$  (0.5 equiv.) in THF at room temperature (Scheme 1).

Red crystals of **3** were obtained in a saturated  $\text{Et}_2\text{O}$  solution at  $-30^\circ\text{C}$  for several days. Compound **3** crystallizes in the  $P-1$  space group (Figure 4). In the solid state, **3** exists as a V-shaped, discrete monomer with the closest Sn...Sn distance [11.649 Å]. The Sn–N bond lengths are 2.091(7), and 2.124(8) Å, with any further metal-ligand interaction being longer than 3.0 Å. The bond angle of N1–Sn1–N2 [118.3(3)°] in **3** is larger than that in  $\text{Sn}[\text{N}(\text{SiMe}_3)_2]_2$  [104.7(2)°].<sup>[21]</sup>

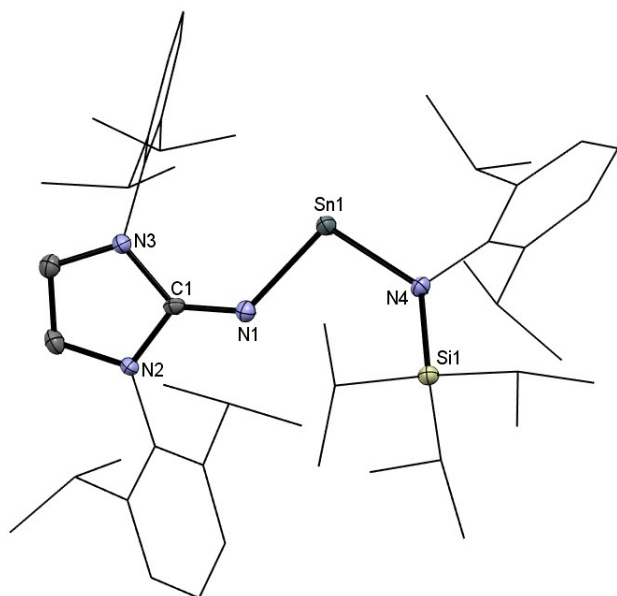
The reaction of **2** with two equivalents of  $\text{IPrNLI}$  ( $\text{IPrN} = \text{bis}(2,6\text{-diisopropylphenyl})\text{imidazolin-2-iminato}$ ) resulted in the amido(imino)stannylene **4** in 70% yield (Scheme 2, path a). Compound **4** was also characterized by multinuclear NMR



**Scheme 2.** Synthesis of amido(imino)stannylene **4** from **2** or **1** with  $\text{IPrNLI}$ .

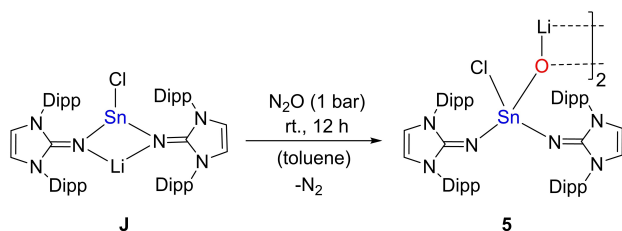
spectroscopy, LIFDI-MS measurements, and elemental analysis (see the Supporting Information for more details). In addition, the isolated yield of **4** did not significantly change when compound **1** reacted directly with  $\text{IPrNLI}$  (1 equiv.) in THF at room temperature (Scheme 2, path b). Compound **4** is soluble in THF, but the solubility decreases significantly in  $\text{C}_6\text{D}_6$ . Notably, it was not possible to observe any signals in the  $^{119}\text{Sn}\{^1\text{H}\}$  NMR spectrum. The NHI signals in the  $^1\text{H}$  NMR spectrum of **4** are more high-field shifted compared to those of the amido(imino)stannylene  $\text{IPrNSn}(\text{TMS})_2$  reported by our group in 2015.<sup>[25]</sup>

Red crystals of **4** were obtained in a saturated  $\text{Et}_2\text{O}$  solution at  $-30^\circ\text{C}$  for several days. Compound **4** crystallizes in the  $P-1$  space group. X-ray diffraction analysis of **4** revealed a monomeric structure (Figure 5). The Sn1–N1 distance of 2.023(2) Å is shorter than the Sn1–N4 distance of 2.112(2) Å, which suggests that the tin center interacts more strongly with the nitrogen atom of the imino ligand than with the nitrogen atom of the amido group. Due to the two bulky substituents the Sn1–N4 distance [2.112(2) Å] in **4** is increased in comparison to that in Lappert's stannylene  $\text{Sn}[\text{N}(\text{SiMe}_3)_2]_2$  [2.09(1) Å].<sup>[21]</sup> The bond angle of N1–Sn1–N4 [100.42(7)°] in **4** is more acute than that in **3** [118.3(3)°].

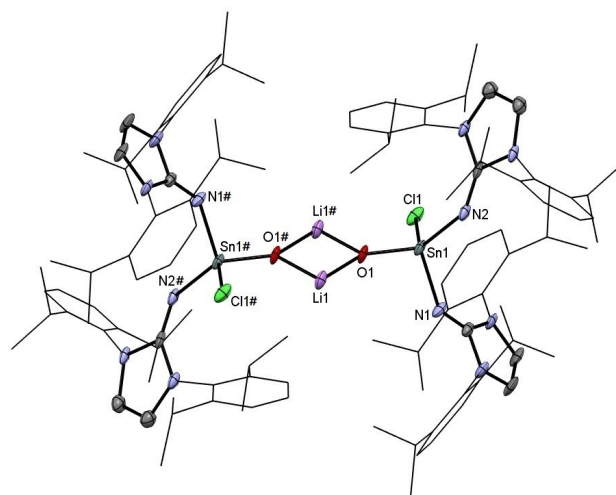


**Figure 5.** Molecular structure of **4**. Thermal ellipsoids are shown at 50% probability level. Hydrogen atoms are omitted for clarity. Selected bond lengths [Å] and angles [°]: Sn1–N1 2.023(2), Sn1–N4 2.112(2), N1–C1 1.281(3), N4–Si1 1.758(2), N1–Sn1–N4 100.42(7), Sn1–N4–Si1 133.5(1), Sn1–N1–C1 128.1(2).

With **3** and **4** in hand, we carried out oxygenation reactions. Both **3** and **4** showed no reactivity towards  $\text{N}_2\text{O}$  (1 bar) in  $\text{C}_6\text{D}_6$ , even at elevated temperatures. Then, we turned to the previously reported bis(imino)stannylene **J**. Interestingly, exposure of a toluene solution of **J** with gaseous  $\text{N}_2\text{O}$  (1 bar) at room temperature led to a tin analogue of lithium alkoxides  $[\text{IPrNSn}(\text{Cl})\text{OLi}]_2$  **5** in 89% yield (Scheme 3). The NHI backbone signal in the  $^1\text{H}$  NMR spectrum of **5** (5.86 ppm,  $\text{C}_6\text{D}_6$ ) is high field shifted compared to that of **J** (5.94 ppm,  $\text{C}_6\text{D}_6$ ). Moreover, the high number of signals of the Dipp groups in the  $^1\text{H}$  NMR spectrum of **5** reflects its less symmetric structure than **J** in solution ( $\text{C}_6\text{D}_6$ ). Compound **5** has a high thermal stability in  $\text{C}_6\text{D}_6$ , and no detectable change was observed in the  $^1\text{H}$  NMR spectrum of **5** in  $\text{C}_6\text{D}_6$  at  $80^\circ\text{C}$  for 24 h. The  $^{119}\text{Sn}\{^1\text{H}\}$  NMR spectrum of **5** in  $\text{C}_6\text{D}_6$  displays a signal for the central tin atom at  $-273.2$  ppm, which is shifted to higher field compared to that of **J** ( $-52.1$  ppm,  $\text{C}_6\text{D}_6$ ). Notably, treating a toluene solution of **1** with  $\text{N}_2\text{O}$  (1 bar) at room temperature resulted in decomposition.



**Scheme 3.** Reaction of bis(imino)stannylene **J** and  $\text{N}_2\text{O}$  to **5**.



**Figure 6.** Molecular structure of **5**. Thermal ellipsoids are shown at 50% probability level. Hydrogen atoms and solvent molecules are omitted for clarity. Selected bond lengths [Å] and angles [°]: Sn1–N1 1.991(6), Sn1–N2 2.010(5), Sn1–O1 1.886(4), Sn1–Cl1 2.384(2), O1–Li1 1.71(1), O1–Li1# 1.96(1), N1–Sn1–N2 110.4(2), N1–Sn1–Cl1 109.5(2), N1–Sn1–O1 101.6(2), N2–Sn1–O1 119.7(2), N2–Sn1–Cl1 106.4(2), Cl1–Sn1–O1 109.1(1), Sn1–O1–Li1 124.3(5), Sn1–O1–Li1# 152.2(4).

Colorless crystals of **5** were obtained in a saturated THF solution at  $-30^\circ\text{C}$  for several months. Compound **5** crystallizes in the  $C2/c$  space group. SC-XRD study revealed that **5** contains a four-membered  $\text{Li}_2\text{O}_2$  ring (Figure 6). A related structure was observed in the cyclic lithium alkoxide  $[\text{Bu}_3\text{COLi}]_2$  reported by Lappert and coworkers.<sup>[26]</sup> The Sn–N bond lengths [Sn1–N1 1.991(6) Å and Sn1–N2 2.010(5) Å] in **5** are shorter than those in **J** [2.143(5) Å and 2.179(4) Å]. The Sn1–Cl1 bond length [2.384(2) Å] is significantly shorter in comparison to that in **J** [2.532(2) Å].

## Conclusion

In summary, we have synthesized stannylene **1** bearing a bulky amido ligand, which was obtained from the reaction of  $\text{Dipp}(\text{Pr}_3\text{Si})\text{NLi}$  with one equivalent of  $\text{SnCl}_2$  in THF at room temperature. Compound **1** can be converted to the dimeric chlorostannylene **2** at  $80^\circ\text{C}$ , with the elimination of  $\text{LiCl}$ . Reduction of **2** with two equivalents of  $\text{KC}_8$  in toluene resulted in bis(amido)stannylene **3**. Moreover, treatment of **2** with  $\text{IPrNLi}$  (2 equiv.) in THF at room temperature led to the formation of amido(imino)stannylene **4**. In addition, treating a toluene solution of bis(imino)stannylene **J** with  $\text{N}_2\text{O}$  resulted in the dimeric complex  $[\text{IPrNSn}(\text{Cl})\text{OLi}]_2$  in high yield. Further small molecule activation, coordination chemistry, and catalytic applications are currently under investigation.

## Experimental Section

**General Considerations:** All experiments and manipulations were carried out under dry oxygen-free argon atmosphere using

standard Schlenk techniques or in a glovebox. All glass junctions were coated with PTFE-based grease Merkel Triboflon III. All the solvents were dried and freshly distilled under Ar atmosphere prior to use by standard techniques. The  $^1\text{H}$ ,  $^{13}\text{C}\{^1\text{H}\}$ ,  $^{119}\text{Sn}\{^1\text{H}\}$ ,  $^{29}\text{Si}\{^1\text{H}\}$  NMR spectra were recorded on Bruker 400 MHz spectrometer. Chemical shifts are referenced to (residual) solvent signals ( $\text{C}_6\text{D}_6$ :  $\delta(^1\text{H}) = 7.16$  ppm and  $\delta(^{13}\text{C}) = 128.06$  ppm). Abbreviations: s = singlet, br. = broadened, d = doublet, t = triplet, m = multiplet. Elemental analysis (EA) was conducted with a EURO EA (HEKA tech) instrument equipped with a CHNS combustion analyzer. Liquid Injection Field Desorption Ionization Mass Spectrometry (LIFDI-MS) was measured directly from an inert atmosphere glovebox with a Thermo Fisher Scientific Exactive Plus Orbitrap equipped with an ion source from Linden CMS. Unless otherwise stated, all commercially available chemicals were purchased from abcr GmbH, Sigma-Aldrich Chemie GmbH or Tokyo Chemical Industry Co., Ltd., and used without further purification. The starting materials  $\text{Dipp}(\text{Pr}_3\text{Si})\text{NLi}$ <sup>[27]</sup> and  $\text{IPrNLi}$ <sup>[28]</sup> were prepared according to the literature procedures, respectively.

**Synthesis of compound 1:**  $\text{Dipp}(\text{Pr}_3\text{Si})\text{NLi}$  (2.0 g, 5.89 mmol) dissolved in THF (40 mL) was added dropwise to a solution of  $\text{SnCl}_2$  (1.12 g, 5.89 mmol, 1.0 equiv.) in THF (20 mL) at room temperature. The reaction mixture was stirred for 2 h. The solvent was removed in vacuo and the solid residue was extracted with toluene (10 mL  $\times$  3). After filtration, the solvent was removed from the filtrate in vacuo to afford **1** as a pale-yellow solid (3.28 g, 83%), and colorless crystals were recrystallized from a saturated solution in *n*-pentane at  $-30^\circ\text{C}$ .

$^1\text{H}$  NMR (400 MHz,  $\text{C}_6\text{D}_6$ )  $\delta/\text{ppm} = 7.19$  (d,  $J = 7.7$  Hz, 2H, ArH), 7.06 (t,  $J = 7.7$  Hz, 1H, ArH), 3.84 (septet,  $J = 6.8$  Hz, 2H,  $\text{CH}(\text{CH}_3)_2$ ), 3.51 (m, 8H, 2,5- $\text{CH}_2$ -THF), 1.48 (septet,  $J = 6.8$  Hz, 3H,  $\text{CH}(\text{CH}_3)_2$ ), 1.39 (d,  $J = 6.8$  Hz, 12H,  $\text{CH}(\text{CH}_3)_2$ ), 1.33 (m, 8H, 3,4- $\text{CH}_2$ -THF), 1.25 (d,  $J = 7.5$  Hz, 18H,  $\text{CH}(\text{CH}_3)_2$ ).

$^{13}\text{C}\{^1\text{H}\}$  NMR (101 MHz,  $\text{C}_6\text{D}_6$ )  $\delta/\text{ppm} = 146.4$  (ArC), 143.6 (ArC), 124.6 (ArC), 124.0 (ArC), 68.2 (2,5- $\text{CH}_2$ -THF), 28.0 ( $\text{CH}(\text{CH}_3)_2$ ), 27.5 ( $\text{CH}(\text{CH}_3)_2$ ), 25.5 (3,4- $\text{CH}_2$ -THF), 24.4 ( $\text{CH}(\text{CH}_3)_2$ ), 19.5 ( $\text{CH}(\text{CH}_3)_2$ ), 14.5 ( $\text{CH}(\text{CH}_3)_2$ ).

$^{119}\text{Sn}\{^1\text{H}\}$  NMR (149 MHz,  $\text{C}_6\text{D}_6$ )  $\delta/\text{ppm} = 197.7$ .

$^{29}\text{Si}\{^1\text{H}\}$  NMR (79 MHz,  $\text{C}_6\text{D}_6$ )  $\delta/\text{ppm} = 7.8$ .

Anal. Calcd. [%] for  $\text{C}_{29}\text{H}_{54}\text{Cl}_2\text{LiNO}_2\text{SiSn}$ : C, 51.73; H, 8.08; N, 2.08. Found [%]: C, 51.70; H, 8.13; N, 2.04.

**Synthesis of compound 3:** Method a: 5 mL toluene was added to a flask containing 2 (300 mg, 308  $\mu\text{mol}$ ) and freshly prepared potassium graphite ( $\text{KC}_8$ ) (83 mg, 616  $\mu\text{mol}$ , 2.0 equiv.) at room temperature with vigorous stirring. Gradually the solution turned dark orange and the stirring was continued for 12 h at room temperature. The resulted solution was filtered, and the solid residue was extracted with toluene (2 mL  $\times$  3). After filtration, the solvent was removed from the filtrate in vacuo to afford **3** as an orange solid (193 mg, 80%), and red crystals were recrystallized from a saturated solution in  $\text{Et}_2\text{O}$  at  $-30^\circ\text{C}$ .

Method b:  $\text{Dipp}(\text{Pr}_3\text{Si})\text{NLi}$  (300 mg, 884  $\mu\text{mol}$ ) dissolved in THF (4 mL) was added dropwise to a solution of  $\text{SnCl}_2$  (84 mg, 442  $\mu\text{mol}$ , 0.5 equiv.) in THF (6 mL) at room temperature. The reaction mixture was stirred for 2 h. The solvent was removed in vacuo and the solid residue was extracted with toluene (10 mL  $\times$  3). After filtration, the solvent was removed from the filtrate in vacuo to afford **3** as an orange solid (616 mg, 89%), and red crystals were recrystallized from a saturated solution in  $\text{Et}_2\text{O}$  at  $-30^\circ\text{C}$ .

$^1\text{H}$  NMR (400 MHz,  $\text{C}_6\text{D}_6$ )  $\delta/\text{ppm} = 6.98$ – $6.96$  (m, 4H, ArH), 6.91– $6.87$  (m, 2H, ArH), 3.58 (septet,  $J = 6.8$  Hz, 4H,  $\text{CH}(\text{CH}_3)_2$ ), 1.35 (septet,  $J =$

6.8 Hz, 6H,  $\text{CH}(\text{CH}_3)_2$ ), 1.26 (d,  $J = 6.8$  Hz, 12H,  $\text{CH}(\text{CH}_3)_2$ ), 1.14 (d,  $J = 7.5$  Hz, 36H,  $\text{CH}(\text{CH}_3)_2$ ), 0.78 (d,  $J = 6.8$  Hz, 12H,  $\text{CH}(\text{CH}_3)_2$ ).

$^{13}\text{C}\{^1\text{H}\}$  NMR (101 MHz,  $\text{C}_6\text{D}_6$ )  $\delta/\text{ppm} = 146.1$  (ArC), 145.5 (ArC), 124.5 (ArC), 124.3 (ArC), 27.8 ( $\text{CH}(\text{CH}_3)_2$ ), 27.7 ( $\text{CH}(\text{CH}_3)_2$ ), 24.2 ( $\text{CH}(\text{CH}_3)_2$ ), 20.0 ( $\text{CH}(\text{CH}_3)_2$ ), 14.7 ( $\text{CH}(\text{CH}_3)_2$ ).

$^{119}\text{Sn}\{^1\text{H}\}$  NMR (149 MHz,  $\text{C}_6\text{D}_6$ )  $\delta/\text{ppm} = 517.5$ .

$^{29}\text{Si}\{^1\text{H}\}$  NMR (79 MHz,  $\text{C}_6\text{D}_6$ )  $\delta/\text{ppm} = 8.7$ .

Anal. Calcd. [%] for  $\text{C}_{42}\text{H}_{76}\text{N}_2\text{Si}_2\text{Sn}$ : C, 64.35; H, 9.77; N, 3.57. Found [%]: C, 63.97; H, 9.95; N, 3.50.

LIFDI-MS: calculated for  $\text{C}_{42}\text{H}_{76}\text{N}_2\text{Si}_2\text{Sn}$ : 784.45690. Found: 784.45133.

**Synthesis of compound 4:** Method a:  $\text{IPrNLi}$  (500 mg, 1.22 mmol) dissolved in THF (10 mL) was added dropwise to a solution of **2** (595 mg, 610  $\mu\text{mol}$ , 0.5 equiv.) in THF (20 mL) at room temperature. The reaction mixture was stirred for 2 h. The solvent was removed in vacuo and the solid residue was extracted with toluene (10 mL  $\times$  3). After filtration, the solvent was removed from the filtrate in vacuo to afford **4** as an orange solid (730 mg, 70%), and red crystals were recrystallized from a saturated solution in  $\text{Et}_2\text{O}$  at  $-30^\circ\text{C}$ .

Method b:  $\text{IPrNLi}$  (500 mg, 1.22 mmol) dissolved in THF (10 mL) was added dropwise to a solution of **1** (822 mg, 1.22 mmol, 1.0 equiv.) in THF (20 mL) at room temperature. The reaction mixture was stirred for 2 h. The solvent was removed in vacuo and the solid residue was extracted with toluene (10 mL  $\times$  3). After filtration, the solvent was removed from the filtrate in vacuo to afford **4** as an orange solid (749 mg, 72%), and red crystals were recrystallized from a saturated solution in  $\text{Et}_2\text{O}$  at  $-30^\circ\text{C}$ .

$^1\text{H}$  NMR (400 MHz,  $\text{C}_6\text{D}_6$ )  $\delta/\text{ppm} = 7.21$ – $7.17$  (m, 3H, ArH), 7.11– $7.08$  (m, 6H, ArH), 6.05 (s, 2H, NCH), 3.72 (septet,  $J = 6.8$  Hz, 2H,  $\text{CH}(\text{CH}_3)_2$ ), 3.14 (septet,  $J = 6.8$  Hz, 4H,  $\text{CH}(\text{CH}_3)_2$ ), 1.56 (septet,  $J = 6.8$  Hz, 3H,  $\text{CH}(\text{CH}_3)_2$ ), 1.34 (d,  $J = 6.8$  Hz, 18H,  $\text{CH}(\text{CH}_3)_2$ ), 1.15 (d,  $J = 6.8$  Hz, 12H,  $\text{CH}(\text{CH}_3)_2$ ), 1.10 (d,  $J = 6.8$  Hz, 24H,  $\text{CH}(\text{CH}_3)_2$ ).

$^{13}\text{C}\{^1\text{H}\}$  NMR (101 MHz,  $\text{C}_6\text{D}_6$ )  $\delta/\text{ppm} = 153.3$  (N $\overline{\text{C}}\text{N}$ ), 147.8 (N $\overline{\text{C}}\text{Ar}$ ), 147.1 (N $\overline{\text{C}}\text{Ar}$ ), 145.9 (N $\overline{\text{C}}\text{Ar}$ ), 134.8 (ArC), 129.8 (ArC), 124.6 (ArC), 123.6 (ArC), 115.2 (N $\overline{\text{C}}\text{H}$ ), 29.1 ( $\text{CH}(\text{CH}_3)_2$ ), 27.9 ( $\text{CH}(\text{CH}_3)_2$ ), 27.1 ( $\text{CH}(\text{CH}_3)_2$ ), 24.9 ( $\text{CH}(\text{CH}_3)_2$ ), 23.7 ( $\text{CH}(\text{CH}_3)_2$ ), 23.1 ( $\text{CH}(\text{CH}_3)_2$ ), 20.0 ( $\text{CH}(\text{CH}_3)_2$ ), 18.9 ( $\text{CH}(\text{CH}_3)_2$ ), 14.3 ( $\text{CH}(\text{CH}_3)_2$ ).

$^{29}\text{Si}\{^1\text{H}\}$  NMR (79 MHz,  $\text{C}_6\text{D}_6$ )  $\delta/\text{ppm} = 4.7$ .

Anal. Calcd. [%] for  $\text{C}_{48}\text{H}_{74}\text{N}_4\text{SiSn}$ : C, 67.51; H, 8.74; N, 6.56. Found [%]: C, 67.81; H, 8.77; N, 6.48.

LIFDI-MS: calculated for  $\text{C}_{48}\text{H}_{74}\text{N}_4\text{SiSn}$ : 854.47047. Found: 854.47222.

**Synthesis of compound 5:** The solution of **J** (1.14 g, 1.30 mmol) in toluene (20 mL) in a Schlenk tube equipped with a PTFE-coated magnetic stirring bar was cooled to be solidified. The upper argon atmosphere was replaced with  $\text{N}_2\text{O}$  gas (1.0 bar). The reaction mixture was allowed to warm to room temperature, and then was stirred for 12 h. Removal of the solvent gave an orange crude solid, and **5** was recrystallized from a saturated solution in THF at  $-30^\circ\text{C}$  as colorless crystals (1.03 g, 89%).

$^1\text{H}$  NMR (400 MHz,  $\text{C}_6\text{D}_6$ )  $\delta/\text{ppm} = 7.28$ – $7.22$  (m, 16H, ArH), 7.18– $7.16$  (m, 8H, ArH), 5.86 (s, 8H, NCH), 3.32 (septet,  $J = 6.8$  Hz, 8H,  $\text{CH}(\text{CH}_3)_2$ ), 3.21 (septet,  $J = 6.8$  Hz, 8H,  $\text{CH}(\text{CH}_3)_2$ ), 1.41 (d,  $J = 6.8$  Hz, 24H,  $\text{CH}(\text{CH}_3)_2$ ), 1.31 (d,  $J = 6.8$  Hz, 24H,  $\text{CH}(\text{CH}_3)_2$ ), 1.26 (d,  $J = 6.8$  Hz, 24H,  $\text{CH}(\text{CH}_3)_2$ ), 1.22 (d,  $J = 6.8$  Hz, 24H,  $\text{CH}(\text{CH}_3)_2$ ).

$^{13}\text{C}\{^1\text{H}\}$  NMR (101 MHz,  $\text{C}_6\text{D}_6$ )  $\delta/\text{ppm} = 154.6$  (N $\overline{\text{C}}\text{N}$ ), 150.3 (N $\overline{\text{C}}\text{Ar}$ ), 148.6 (N $\overline{\text{C}}\text{Ar}$ ), 147.1 (N $\overline{\text{C}}\text{Ar}$ ), 136.0 (ArC), 129.1 (ArC), 124.3 (ArC), 124.2 (ArC), 114.5 (N $\overline{\text{C}}\text{H}$ ), 29.0 ( $\text{CH}(\text{CH}_3)_2$ ), 28.9 ( $\text{CH}(\text{CH}_3)_2$ ), 25.1

(CH(CH<sub>3</sub>)<sub>2</sub>), 24.9 (CH(CH<sub>3</sub>)<sub>2</sub>), 24.7 (CH(CH<sub>3</sub>)<sub>2</sub>), 24.5 (CH(CH<sub>3</sub>)<sub>2</sub>), 24.0 (CH(CH<sub>3</sub>)<sub>2</sub>), 23.6 (CH(CH<sub>3</sub>)<sub>2</sub>).

<sup>119</sup>Sn{<sup>1</sup>H} NMR (149 MHz, C<sub>6</sub>D<sub>6</sub>) δ/ppm = -273.2.

Anal. Calcd. [%] for C<sub>108</sub>H<sub>144</sub>Cl<sub>2</sub>Li<sub>2</sub>N<sub>12</sub>O<sub>2</sub>Sn<sub>2</sub>: C, 66.03; H, 7.39; N, 8.56. Found [%]: C, 66.00; H, 7.45; N, 8.50.

Deposition Numbers 2191800 (for 1), 2191801 (for 2), 2191802 (for 3), 2191803 (for 4), and 2191804 (for 5) contain the supplementary crystallographic data for this paper. These data are provided free of charge by the joint Cambridge Crystallographic Data Centre and Fachinformationszentrum Karlsruhe Access Structures service.

**Supporting Information:** NMR spectra, crystallographic details including ORTEP representations.

## Acknowledgements

We gratefully acknowledge financial support from the Deutsche Forschungsgemeinschaft (In 234/7-1). X.Z. gratefully acknowledges financial support from the China Scholarship Council. We thank Maximilian Muhr for the LIFDI-MS measurements. Open Access funding enabled and organized by Projekt DEAL.

## Conflict of Interest

The authors declare no conflict of interest.

## Data Availability Statement

The data that support the findings of this study are available in the supplementary material of this article.

**Keywords:** low-coordinate compounds · N-donor ligands · oxidation · stannylene · stannyleneid

- [1] a) F. T. Edelmann, D. M. Freckmann, H. Schumann, *Chem. Rev.* **2002**, *102*, 1851–1896; b) G.-X. Wang, J. Yin, J. Li, Z.-B. Yin, W.-X. Zhang, Z. Xi, *Inorg. Chem. Front.* **2019**, *6*, 428–433; c) C. Yu, W. Ma, W.-X. Zhang, Z. Xi, *Organometallics* **2020**, *39*, 793–796; d) C. Yu, B. Wu, Z. Yang, H. Chen, W.-X. Zhang, Z. Xi, *Bull. Chem. Soc. Jpn.* **2020**, *93*, 1314–1318; e) Y. Zheng, C. S. Cao, W. Ma, T. Chen, B. Wu, C. Yu, Z. Huang, J. Yin, H. S. Hu, J. Li, W. X. Zhang, Z. Xi, *J. Am. Chem. Soc.* **2020**, *142*, 10705–10714.
- [2] Y. Zhang, Z. Yang, W. X. Zhang, Z. Xi, *Chem. Eur. J.* **2019**, *25*, 4218–4224.
- [3] C. Yu, M. Zhong, Y. Zhang, J. Wei, W. Ma, W. X. Zhang, S. Ye, Z. Xi, *Angew. Chem. Int. Ed.* **2020**, *59*, 19048–19053; *Angew. Chem.* **2020**, *132*, 19210–19215.
- [4] L. Xu, Y. C. Wang, J. Wei, Y. Wang, Z. Wang, W. X. Zhang, Z. Xi, *Chem. Eur. J.* **2015**, *21*, 6686–6689.
- [5] a) B. Shen, L. Ying, J. Chen, Y. J. Luo, *Inorg. Chim. Acta* **2008**, *361*, 1255–1260; b) Y. Luo, X. Wang, J. Chen, C. Luo, Y. Zhang, Y. Yao, *J. Organomet. Chem.* **2009**, *694*, 1289–1296; c) Y. Luo, S. Fan, J. Yang, J. Fang, P. Xu, *Dalton Trans.* **2011**, *40*, 3053–3059.
- [6] a) S. Molitor, V. H. Gessner, *Synlett* **2015**, *26*, 861–865; b) V. H. Gessner, *Chem. Commun.* **2016**, *52*, 12011–12023; c) S. Molitor, V. H. Gessner, *Chem. Eur. J.* **2013**, *19*, 11858–11862; d) S. Molitor, J. Becker, V. H. Gessner, *J. Am. Chem. Soc.* **2014**, *136*, 15517–15520; e) S. Molitor, V. H. Gessner, *Angew. Chem. Int. Ed.* **2016**, *55*, 7712–7716; *Angew. Chem.* **2016**, *128*, 7843–7847; f) T. Hata, H. Kitagawa, H. Masai, T. Kurahashi, M. Shimizu, T. Hiyama, *Angew. Chem. Int. Ed.* **2001**, *40*, 790–792; *Angew. Chem.* **2001**, *113*, 812–814; g) T. Kurahashi, T. Hata, H. Masai, H. Kitagawa, M. Shimizu, T. Hiyama, *Tetrahedron* **2002**, *58*, 6381–6395; h) H. Heuclin, S. Y. Ho, X. F. Le Goff, C. W. So, N. Mezailles, *J. Am. Chem. Soc.* **2013**, *135*, 8774–8777; i) S. Y. Ho, C. W. So, N. Saffon-Merceron, N. Mezailles, *Chem. Commun.* **2015**, *51*, 2107–2110; j) Z. Wu, X. Sun, K. Potter, Y. Cao, L. N. Zakharov, P. R. Blakemore, *Angew. Chem. Int. Ed.* **2016**, *55*, 12285–12289; *Angew. Chem.* **2016**, *128*, 12473–12477; k) S. Molitor, V. H. Gessner, *Chem. Eur. J.* **2017**, *23*, 12372–12379; l) K. Dilchert, T. Scherpf, V. H. Gessner, *Eur. J. Inorg. Chem.* **2020**, *2020*, 4111–4115; m) K. Dilchert, M. Schmidt, A. Grossjohann, K. S. Feichtner, R. E. Mulvey, V. H. Gessner, *Angew. Chem. Int. Ed.* **2021**, *60*, 493–498; *Angew. Chem.* **2021**, *133*, 498–504.
- [7] a) G. Boche, M. Marsch, A. Müller, K. Harms, *Angew. Chem. Int. Ed.* **1993**, *32*, 1032–1033; *Angew. Chem.* **1993**, *105*, 1081–1082; b) G. Boche, J. C. Lohrenz, *Chem. Rev.* **2001**, *101*, 697–756.
- [8] a) E. Niecke, P. Becker, M. Nieger, D. Stalke, W. W. Schoeller, *Angew. Chem. Int. Ed.* **1995**, *34*, 1849–1852; *Angew. Chem.* **1995**, *107*, 2012–2015; b) E. Niecke, M. Nieger, O. Schmidt, D. Gudat, W. W. Schoeller, *J. Am. Chem. Soc.* **1999**, *121*, 519–522.
- [9] T. Cantat, X. Jacques, L. Ricard, X. F. Le Goff, N. Mezailles, P. Le Floch, *Angew. Chem. Int. Ed.* **2007**, *46*, 5947–5950; *Angew. Chem.* **2007**, *119*, 6051–6054.
- [10] a) A. Kawachi, K. Tamao, *Bull. Chem. Soc. Jpn.* **1997**, *70*, 945–955; b) Y. Tanaka, M. Hada, A. Kawachi, K. Tamao, H. Nakatsuji, *Organometallics* **1998**, *17*, 4573–4577; c) K. Tamao, A. Kawachi, M. Asahara, A. Toshimitsu, *Pure Appl. Chem.* **1999**, *71*, 393–400; d) D. Feng, J. Xie, S. Feng, *Chem. Phys. Lett.* **2004**, *396*, 245–251.
- [11] a) N. Tokitoh, K. Hatano, T. Sadahiro, R. Okazaki, *Chem. Lett.* **1999**, *28*, 931–932; b) K. Hatano, N. Tokitoh, N. Takagi, S. Nagase, *J. Am. Chem. Soc.* **2000**, *122*, 4829–4830.
- [12] a) M. E. Lee, H. M. Cho, Y. M. Lim, J. K. Choi, C. H. Park, S. E. Jeong, U. Lee, *Chem. Eur. J.* **2004**, *10*, 377–381; b) Y. M. Lim, H. M. Cho, M. E. Lee, K. K. Baek, *Organometallics* **2006**, *25*, 4960–4964; c) H. M. Cho, Y. M. Lim, M. E. Lee, *Dalton Trans.* **2010**, *39*, 9232–9234; d) H. M. Cho, Y. M. Lim, B. W. Lee, S. J. Park, M. E. Lee, *J. Organomet. Chem.* **2011**, *696*, 2665–2668.
- [13] G. Molev, D. Bravo-Zhivotovskii, M. Karni, B. Tumanskii, M. Botoshansky, Y. Apeloig, *J. Am. Chem. Soc.* **2006**, *128*, 2784–2785.
- [14] T. Ohtaki, W. Ando, *Organometallics* **1996**, *15*, 3103–3105.
- [15] Y. Suzuki, T. Sasamori, J. D. Guo, S. Nagase, N. Tokitoh, *Chem. Eur. J.* **2016**, *22*, 13784–13788.
- [16] A. M. Arif, A. H. Cowley, T. M. Elkins, *J. Organomet. Chem.* **1987**, *325*, C11–C13.
- [17] a) H. Arp, J. Baumgartner, C. Marschner, T. Müller, *J. Am. Chem. Soc.* **2011**, *133*, 5632–5635; b) H. Zhao, J. Li, X. Q. Xiao, M. Kira, Z. Li, T. Müller, *Chem. Eur. J.* **2018**, *24*, 5967–5973.
- [18] C. Yan, Z. Li, X. Q. Xiao, N. Wei, Q. Lu, M. Kira, *Angew. Chem. Int. Ed.* **2016**, *55*, 14784–14787; *Angew. Chem.* **2016**, *128*, 15004–15007.
- [19] T. Ochiai, D. Franz, X. N. Wu, E. Irran, S. Inoue, *Angew. Chem. Int. Ed.* **2016**, *55*, 6983–6987; *Angew. Chem.* **2016**, *128*, 7097–7101.
- [20] M. Auer, F. Diab, K. Eichele, H. Schubert, L. Wesemann, *Dalton Trans.* **2022**, *51*, 5950–5961.
- [21] T. Fjeldberg, H. Hope, M. F. Lappert, P. P. Power, A. J. Thorne, *J. Chem. Soc. Chem. Commun.* **1983**, 639–641.
- [22] P. M. Keil, T. J. Hadlington, *Chem. Commun.* **2022**, *58*, 3011–3014.
- [23] R. S. Simons, L. Pu, M. M. Olmstead, P. P. Power, *Organometallics* **1997**, *16*, 1920–1925.
- [24] M. M. D. Roy, S. R. Baird, E. Dornsiepen, L. A. Paul, L. Miao, M. J. Ferguson, Y. Zhou, I. Siewert, E. Rivard, *Chem. Eur. J.* **2021**, *27*, 8572–8579.
- [25] T. Ochiai, D. Franz, E. Irran, S. Inoue, *Chem. Eur. J.* **2015**, *21*, 6704–6707.
- [26] G. Beck, P. B. Hitchcock, M. F. Lappert, I. A. MacKinnon, *J. Chem. Soc. Chem. Commun.* **1989**, 1312–1314, <https://pubs.rsc.org/en/content/articlelanding/1989/C3/C39890001312>.
- [27] B. Shen, L. Ying, J. Chen, Y. J. Luo, *Inorg. Chim. Acta* **2008**, *361*, 1255–1260, <https://www.sciencedirect.com/science/article/pii/S0020169307004975>.
- [28] D. Franz, E. Irran, S. Inoue, *Dalton Trans.* **2014**, *43*, 4451–4461, <https://pubs.rsc.org/en/content/articlelanding/2014/dt/c3dt52637b>.

Manuscript received: August 30, 2022  
Accepted manuscript online: October 4, 2022  
Version of record online: November 16, 2022