

## Methods

# Sniffing fungi – phenotyping of volatile chemical diversity in *Trichoderma* species

Yuan Guo<sup>1\*</sup> , Werner Jud<sup>1\*</sup> , Andrea Ghirardo<sup>1</sup> , Felix Antritter<sup>1</sup>, J. Philipp Benz<sup>2</sup> , Jörg-Peter Schnitzler<sup>1</sup>  and Maaria Rosenkranz<sup>1</sup> 

<sup>1</sup>Research Unit Environmental Simulation, Institute of Biochemical Plant Pathology, Helmholtz Zentrum München, D-85764, Neuherberg, Germany; <sup>2</sup>Holzforchung München, TUM School of Life Sciences Weihenstephan, Technical University of Munich, D-85354, Freising, Germany

Author for correspondence:

Maaria Rosenkranz

Tel: +49 89 3187 4469

Email: maaria.rosenkranz@helmholtz-muenchen.de

Received: 14 November 2019

Accepted: 26 February 2020

New Phytologist (2020)

doi: 10.1111/nph.16530

**Key words:** automated cuvettes, chemical diversity, data mining, fungi, GC-MS, Proton transfer reaction-time of flight-MS, *Trichoderma*, volatile organic compound (VOC) emission.

## Summary

- Volatile organic compounds (VOCs) play vital roles in the interaction of fungi with plants and other organisms. A systematic study of the global fungal VOC profiles is still lacking, though it is a prerequisite for elucidating the mechanisms of VOC-mediated interactions. Here we present a versatile system enabling a high-throughput screening of fungal VOCs under controlled temperature. In a proof-of-principle experiment, we characterized the volatile metabolic fingerprints of four *Trichoderma* spp. over a 48 h growth period.
- The developed platform allows automated and fast detection of VOCs from up to 14 simultaneously growing fungal cultures in real time. The comprehensive analysis of fungal odors is achieved by employing proton transfer reaction-time of flight-MS and GC-MS. The data-mining strategy based on multivariate data analysis and machine learning allows the volatile metabolic fingerprints to be uncovered.
- Our data revealed dynamic, development-dependent and extremely species-specific VOC profiles from the biocontrol genus *Trichoderma*. The two mass spectrometric approaches were highly complementary to each other, together revealing a novel, dynamic view to the fungal VOC release.
- This analytical system could be used for VOC-based chemotyping of diverse small organisms, or more generally, for any *in vivo* and *in vitro* real-time headspace analysis.

## Introduction

Fungi are known to emit a wide range of volatile organic compounds (VOCs) with high chemical diversity, including alcohols, benzenoids, aldehydes, alkenes, acids, esters, terpenoids and ketones (Morath *et al.*, 2012; Li *et al.*, 2016; Lemfack *et al.*, 2017; Misztal *et al.*, 2018). VOCs are characterized by low molecular weight, high vapor pressure and polarity (Lee *et al.*, 2019). VOCs evaporate easily at room temperature and are distributed into the surrounding air, enabling them to act as signal substances in intra- and interorganismic communication (Insam & Seewald, 2010; Penuelas *et al.*, 2014; Kanchiswamy *et al.*, 2015). More than 300 fungal VOCs (fVOCs) have been identified so far (Hung *et al.*, 2015) and the number of identified compounds, as well as the number of microbial species analyzed for their VOCs, continues to increase. This can be well deduced from the increasing number of entries in the database of microbial volatiles (mVOC database) (Lemfack *et al.*, 2017). In the last decade, progress has also been

made in understanding the ecological functions of fVOCs and how they might mediate interorganismic communication (Piechulla *et al.*, 2017; Li *et al.*, 2018). fVOCs may play crucial roles in the formation and regulation of symbiotic associations and in the distribution of saprophytic, mycorrhizal and pathogenic organisms in the ecosystem (Hung *et al.*, 2015; Kanchiswamy *et al.*, 2015; Mhlongo *et al.*, 2018). An ecological function has only been described for a few individual fVOCs and, moreover, knowing that the released fVOCs depend strongly on the developmental stage and environmental conditions (Romoli *et al.*, 2014; Schmidt *et al.*, 2015; Weigl *et al.*, 2016), so far, the scientists have probably only revealed the tip of the iceberg. A systematic research on the global VOC profile of fungi is still lacking, although it is a prerequisite for elucidating the mechanisms of fVOC-mediated organismic interactions.

Over the past 10–20 yr the methods and analytical techniques for measuring VOCs have evolved considerably (Zhang & Li, 2010; Misztal *et al.*, 2018). This development has had an impact on the analysis of volatile compounds from microbes and fungi, which have complex scent profiles and, given the high number

\*These authors contributed equally to this work.

existing on Earth, bear the potential to identify new substances (Zhang & Li, 2010; Hung *et al.*, 2015; Lemfack *et al.*, 2017). So far, technologies such as GC-MS have dominated the analysis of fVOCs owing to the reliable and cost-effective separation, identification and quantification of substances (Matysik *et al.*, 2009; Morath *et al.*, 2012; Siddiquee *et al.*, 2012). Recently GC-MS analyses were often combined with a passive VOC collection (e.g. stir bar sorptive extraction, SBSE) (Wihlborg *et al.*, 2008; Bicchi *et al.*, 2009; Zhang & Li, 2010). The required pre-enrichment of VOCs before the GC-MS analysis (and the GC-MS run itself; Bicchi *et al.*, 2009) can, however, be time-consuming and, moreover, do not enable real-time detection of volatile compounds. Thus, so far fVOC analyses have mostly been conducted at low time resolution as a result of the long collection time necessary for proper detection (e.g. 6 h or 16 h) (A. Müller *et al.*, 2013; Guo *et al.*, 2019). Further bias might rise from common adsorption materials that preferably trap medium- to high-molecular-weight compounds and from the use of thermodesorption units that favor medium-to-high thermostable analytes (Kataoka *et al.*, 2000; Marcillo *et al.*, 2017). The separation ability of a GC column and sensitivity to specific compounds depends, moreover, on the specific physical properties of the stationary phase in the column. Employing polar and nonpolar stationary phases would theoretically allow detection of a wider range of compounds but also request longer sampling time (Mondello *et al.*, 2005).

As the interest in fungal and other microbial VOCs in interorganismic interactions has increased considerably (Penuelas *et al.*, 2014; Werner *et al.*, 2016), the demand of a new generation of analytical technology enabling fast, real-time detection of microbial VOCs has become imperative. A promising tool to achieve the new goal is employment of proton transfer reaction-MS (PTR-MS) in combination with a time-of-flight (ToF) analyzer (Lindinger & Jordan, 1998; Graus *et al.*, 2010). The PTR-ToF-MS allows quick VOC measurements with high sensitivity and high mass resolution (*c.* 4000–5000  $m\Delta m^{-1}$ ) in a typical mass range of 15 to *c.* 350 amu (Graus *et al.*, 2010). The high mass resolution makes it possible to separate isobaric compounds (e.g. pure hydrocarbons) from isobaric oxygenated molecules (Romano *et al.*, 2015). The limit of detection (LOD) of a PTR-ToF-MS is currently  $\leq$  a few parts per trillion volume compared to parts per billion of GC-MS (Thet & Woo, 2019). However, the PTR-ToF-MS is not able to separate isomers and therefore a proper compound identification may become tedious or even impossible for heavier molecules. For example, sesquiterpenes are a class of terpenoids that, having many chemical structures but usually the same chemical formula (Chadwick *et al.*, 2013), are detected as a single mass by PTR-ToF-MS. Our setup therefore combines the strengths of both the PTR-ToF-MS, allowing the fungal emissions to be monitored in a semi-online fashion, and the GC-MS, also allowing the compounds with similar masses to be identified.

Proton transfer reaction-ToF-MS has previously been used to measure volatile emissions from plants (Farneti *et al.*, 2015; Li *et al.*, 2019), soils (Veres *et al.*, 2014; Mancuso *et al.*, 2015), yeast (Khomenko *et al.*, 2017) and also from bacteria and fungi (Adams

*et al.*, 2017; Infantino *et al.*, 2017; Misztal *et al.*, 2018). These studies have employed online MS, which, however, benefits from further GC complementation of the chemical formulas with structural isomer information. To analyze complete volatilome and temporal fluctuation in emission patterns, a controlled high-throughput analysis platform is necessary. Such a platform is a first desirable step to determining development and environment-dependent fVOC profiles. It is also the first step to deciphering the VOC-based intra- and interspecies-specific chemical diversity. The large and complex fVOC datasets generated by such a platform are, however, challenging for the classic statistic approaches suitable for simpler datasets (Bzdok *et al.*, 2018; Xu & Jackson, 2019). Instead, a machine learning approach, which has huge potential to analyze the increasingly complex biological -omics data (Camacho *et al.*, 2018), is instrumental to uncovering the sophisticated fVOCs factors and patterns.

In this study, we present an automated, online VOC monitoring cuvette system that allows the *in vivo* analysis of time series of fVOC emissions to dynamically capture changes in the fungal odor profiles.

In combination with PTR-ToF-MS, SBSE-GC-MS and a data-mining approach (combining statistics and supervised and unsupervised machine learning), we investigated the chemical diversity of four *Trichoderma* (Hypocreales, Ascomycota) species, including *T. harzianum* (WM24a1), *T. hamatum* (QL15d1), *T. reesei* (QM6a) and *T. velutinum* (GL15b1). *Trichoderma* spp. are able to establish in the rhizosphere of host plants, leading to beneficial effects (Guzmán-Guzmán *et al.*, 2018). The growth-promoting effects are based on mobilization of nutrients (Harman, 2011), induction of plant systemic resistance (Shoresh *et al.*, 2010; Estrada-Rivera *et al.*, 2019), and a mycotrophic lifestyle towards plant pathogens (Druzhinina *et al.*, 2011; Kubicek *et al.*, 2011). Recent studies show very species-specific volatile profiles for *Trichoderma* (Siddiquee *et al.*, 2012; Lee *et al.*, 2016; Guo *et al.*, 2019), whose patterns can drastically change in interaction with other organisms (Guo *et al.*, 2019), suggesting important ecological functions for fVOCs of *Trichoderma*. In the present study, the complement of PTR-ToF-MS and GC-MS allowed us to obtain comprehensive measurements of the odor profiles of the four *Trichoderma* species. The applied data-mining strategy formed a crucial part of our fVOC measurement system, facilitating the elucidation of fVOCs and hence paving the way to unearth the fVOC-mediated organismic communication. The demonstrated automated system proved to be a very time-effective strategy for characterizing the intraspecific chemical diversity of the *Trichoderma* volatiles. It allowed access to biologically driven changes of an individual volatile emission in real time. Within the present work, by investigating the fast-growing *Trichoderma* species, we demonstrate a proof-of-principle of a strategy to decipher fungal – as well as other microbial – volatilomes in solitary cultures and in interactions with each other.

## Materials and Methods

### Fungal species and cultivation

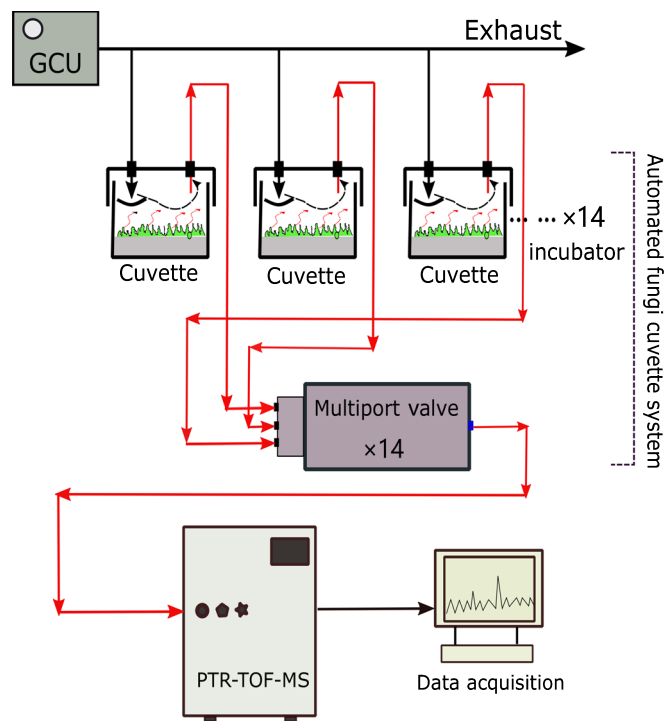
Four *Trichoderma* species (*Trichoderma harzianum* WM24a1, *Trichoderma hamatum* QL15d1, *Trichoderma reesei* QM6a and

*Trichoderma velutinum* GL1561, all kindly provided by Monica Schmoll, Austrian Institute of Technology, Tulln, Austria) were used for the fVOC analysis. The fungi were cultivated in glass cuvettes (7 cm diameter and 6.6 cm depth, total volume *c.* 254 ml) containing modified Melin-Norkrans synthetic medium (40 ml per cuvette; described previously by A. Müller *et al.*, 2013) and were grown in a chamber at 23°C and continuous darkness (Guo *et al.*, 2019). VOC analysis was started at the beginning of the exponential hyphal growth stage, because most secondary metabolites of fungi are produced in this period, which is after completion of its initial growth and right before the next developmental stage, represented by the formation of spores (Calvo *et al.*, 2002). Before the study, growth curves of the four *Trichoderma* species were used to determine the exponential growth stage (Supporting Information Fig. S1). Pictures of the *Trichoderma* cultures were taken at the beginning and at the end of the PTR-ToF-MS measurements (Fig. S2).

### Measurement system

The outline of the measurement platform is illustrated in Fig. 1. The core element of the platform was the cuvette system integrated in a growth incubator (Model 3100 Series, Thermo Scientific, Marietta, OH, USA), which allows cultivation of fungi under well controlled temperature conditions (23°C in the present study). The system consisted of a series of 14 glass cuvettes (the same ones in which the fungi were cultivated; 7 cm diameter, 6.6 cm depth) with gas-tight tin plate lids covered with a Teflon sheet (0.12 mm thick) at the bottom to minimize fVOC deposition. The lids each contained two stainless steel bulkhead unions for connection of the air supply and the sample line. A gas calibration unit (GCU; Ionicon Analytik GmbH, Innsbruck, Austria) provided VOC-free air at the desired water moisture content under ambient CO<sub>2</sub> concentration. This clean and humidified air (70% relative humidity at 22°C) is used to flush the cuvettes and tubes during PTR-ToF-MS analysis. The cuvette inflow was diverted by a Teflon deflector in order to avoid a direct air stream onto the fungi, which had been shown to affect fungal growth. The lines from the cuvettes to the inlet of the PTR-ToF-MS were heated to 40°C to avoid condensation and limit VOC adsorption onto the sample lines. A multiport valve (C25Z-31814D; VICI-Valco, Houston, TX, USA) served as a central control for the sequential sampling of air from the individual cuvettes. The switching of the multiport valve between the different cuvettes and the data acquisition process were controlled by PTR-MANAGER, a piece of software shipped with the PTR-ToF-MS. The online PTR-ToF-MS data were recorded using ToFDAQ software (Tofwerk AG, Thun, Switzerland). The data were stored in a hierarchical data file format (HDF5) which includes meta information on data acquisition parameters.

All tubings assembled in the cuvette system consist of polytetrafluoroethylene (PTFE) or PFA Teflon, or polyether ether ketone to minimize deposition and reactions of VOCs on the surfaces (Jud *et al.*, 2018). In order to prevent fungal spores from entering the reaction chamber of the PTR-ToF-MS, a BOLA single-stage PFA flow filter (Bohlender GmbH, Grünsfeld,

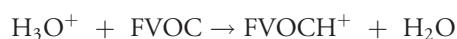


**Fig. 1** Schematic of the multiple cuvette system. Fourteen glass cuvettes (labeled 1–14) were integrated in an incubator. The transfer lines (red) from the cuvette outlets and of the multiport valve to the proton transfer reaction-time-of-flight-MS (PTR-ToF-MS) analyzer were heated up to 40°C with an encapsulated heating line to increase the vapour pressure of the substances and to keep deposition on the line surface as low as possible. The gas calibration unit (GCU) was used to generate ultraclean carrier gas stream for conduction of headspace fungal volatile organic compounds (fVOCs). The multiport valve serves as a central control for the sequential sampling of air from the individual cuvettes. Cuvette 1 (kept empty) and cuvette 2 (sole media) were used to monitor and correct background emission.

Germany) containing a PTFE filtering membrane (5 µm pore size) was installed between the multiport valve and the PTR-ToF-MS. The cuvette system was operated in a slight overpressure mode by connecting a high-efficiency particulate air (HEPA) filter at the outlet of the exhaust line. This helped to prevent ambient air leaking into the cuvettes.

### fVOC measurements by PTR-ToF-MS

The dynamic emissions of fVOCs emitted by the *Trichoderma* species were measured sequentially using a PTR-ToF-MS (Ionicon Analytik GmbH, Innsbruck, Austria). In a PTR-ToF-MS, VOCs with a proton affinity higher than that of water (691 kJ mol<sup>-1</sup>; Hunter & Lias, 1998) are ionized via proton transfer from primary H<sub>3</sub>O<sup>+</sup> ions according to the following reaction scheme:



The measurement system was run at stable, well-defined conditions. The inlet flow rate was set at 450 standard cm<sup>3</sup> min<sup>-1</sup>.



The PTR-ToF-MS ion drift tube was operated at 60°C, 540 V drift voltage and 2.3 mbar drift pressure, corresponding to an  $E/N$  of 120 Td ( $E$  being the electric field strength and  $N$  the gas number density; 1 Td =  $10^{-17}$  V cm<sup>2</sup>).

The cuvette inlet flow ( $F_{in}$ ) and the cuvette volume  $V$  define two important parameters of the cuvette system: the characteristic time constant  $\tau$  and its reverse, the exchange rate  $1/\tau$  of the cuvette system:

$$\tau = \frac{V}{F_{in}}$$

With a cuvette inlet flow of 450 ml min<sup>-1</sup> and a cuvette volume of 254 ml, it takes 2.82 min ( $5\tau$ ) until the air inside one of the cuvettes was exchanged to more than 99% (Graus, 2005).

The measurement procedure consisted in continuous switching between the 14 cuvettes. Cuvette no. 1 was completely empty and served as reference. Cuvette no. 2 was containing growth medium only and was used to detract the signal background from the cuvette nos. 3 to 14 containing fungi. Every time before switching from one cuvette to the next, the system was switched for 10 s to the completely empty background cuvette in order to flush the sample lines with zero air. This helps to avoid carrying over VOCs from the preceding cuvette into the sample air of the following cuvette. From each cuvette we sampled for 5 min, during which air was drawn into the PTR-ToF-MS. When not been sampled, the air in the cuvettes was resting and fVOCs accumulated for *c.* 70 min.

The PTR-ToF-MS raw data were analyzed using the routines described in M. Müller *et al.* (2013) and Jud *et al.* (2018). The calculated signals in counts per second (cps) were normalized to 10<sup>6</sup> reagent ion counts (sum of the signals of H<sub>3</sub>O<sup>+</sup> and its cluster, H<sub>3</sub>O<sup>+</sup>·H<sub>2</sub>O, divided by 10<sup>6</sup>) to account for differences in the absolute humidity in the different cuvettes. Eventually, we got the signals in normalized cps (ncps).

After the raw data of the PTR-ToF-MS measurements were evaluated and separated cuvette-wise, the TOF DATA PLOTTER program (see <https://sites.google.com/site/prttof/file-cabinet>) was used to visualize the data and calculate the fungus-specific volatile signals. From a list of about 500 peaks present in the mass spectra we narrowed down the number of mass over charge ratios ( $m/z$ ,  $z=1$ ) for further analysis by going manually through all spectra (using DATA PLOTTER) and searching for those showing differences between the background and the fungi cuvettes. Additionally, all  $m/z$  attributable to isotope signals were removed. This way we ended up with a list of 56 mass features/compounds.

The  $m/z$  signals were first background-corrected by subtracting the signal of the cuvette containing only growth medium. To this end, cubic splines were fitted through the mean signals measured from the growth medium cuvette throughout the whole measurement and the interpolated signals were then subtracted from all fungi cuvette signals measured in between.

Afterwards, the time traces of the signals were separated cuvette-wise and the cumulative signals of all  $m/z$  of interest in each cuvette sample interval were calculated. Except for analyzing the time series, the data (cumulative signal of 5 min) points over

the whole measurement period were averaged in each cuvette. Eventually, the data were normalized to the respective area of fungal mycelium and the *c.* 70 min accumulation time for further analysis. Lacking authentic calibration standards of many of the detected compounds (identified with the GC-MS) and signal interferences of isomers we refrained from further converting the cumulative ncps in actual amounts (e.g. in nmol).

The nontargeted feature of PTR-ToF-MS measurements challenges the precise identification of the detected mass, particular for the separation of the chemical classes 'ketone' and 'aldehyde'. The lack of commercially available standards and PTR-ToF-MS-based fVOC literature, moreover, hindered the annotations of the detected masses. Nevertheless the annotation was greatly helped by the previously reported VOCs on mainly soil matrix as well as PTR-ToF-MS-based fungal and plant VOC records and the mVOC database (Table S1; Lemfack *et al.*, 2017). To validate the annotations, we manually checked the degree of match and alignment with the isotopic patterns. Further, to improve the annotation rate, we determined the correlation ( $R^2 > 0.8$ ) for the masses that are most likely a fragment of a (related) compound using the TOF DATA PLOTTER programme. Taking the above-mentioned strategies together, we carefully annotated the detected masses as tentatively assigned compounds.

#### fVOC measurements with GC-MS

The VOCs from *Trichoderma* species were collected with the SBSE technique (polydimethylsiloxane (PDMS) twisters; Gerstel GmbH, Mülheim an der Ruhr, Germany) and analyzed as described previously (Guo *et al.*, 2019). After the analysis with PTR-ToF-MS, twisters were fixed onto the inner side of the lid (with a magnet mounted outside the lid) and allowed to trap fVOCs over a period of 16 h. The fVOCs were analyzed by thermal desorption (TDU, Gerstel) GC-MS (GC type 7890A, MS type 5975C; Agilent Technologies, Palo Alto, CA, USA) using a 5% phenyl 95% dimethyl arylene siloxane capillary column (70 m × 250 μm × 25 μm DB-5MS + 10 m DG; Agilent Technologies). The TDU-GC-MS was run following the well-established procedures (Ghirardo *et al.*, 2012, 2016). The general GC-MS parameters are given in Weikl *et al.* (2016), further modified by Guo *et al.* (2019). Peak annotation and quantification followed Guo *et al.* (2019) and Kreuzwieser *et al.* (2014). GC-MS data were normalized to the area of fungal mycelium and VOC collection time. For calculating the LOD (Table S2), three sigma ( $\sigma$ ) of the background signals were used (Shrivastava & Gupta, 2011).

#### Statistics

All data analysis and visualization were performed in R v.3.6.1 (R Core Team, 2018). Time series analysis were performed on the PTR-ToF-MS dataset with the 'dtwclust' package (Sarda-Espinosa *et al.*, 2019) with 'gak' distance and 'median' centroid. Principal component analysis (PCA) was used to analyze the volatile emission patterns of the four species using merged PTR-ToF-MS and GC-MS dataset. Data were standardized to have

means of 0 and variance of 1 to remove the effects of different units and scales (Maynard *et al.*, 2019). PCA was performed using the 'prcomp' function with GGFORTIFY package (Tang *et al.*, 2016). The variables contribution was extracted with 'fviz\_contrib' function in the FACTOEXTRA package (Kassambara & Mundt, 2017). Data were *z*-score-standardized internally before time series analysis to obtain static features (Tang *et al.*, 2016; Sardá-Espinosa, 2017). Random forest (RF) analysis (Breiman, 2001) was performed to elucidate the important compounds discriminating the four *Trichoderma* species. The number of variables that randomly sampled as candidates at each split (mtry) and the number of trees to grow (ntree) were tuned (grid search) using the caret package (Kuhn, 2008) to obtain the optimal predictive ability, stability and accuracy. RF analysis was performed separately on the PTR-ToF-MS and GC-MS datasets, to avoid the possible influence of scale difference and sparsity difference (Karlsson & Boström, 2014).

## Results

### General features of combining PTR-ToF-MS, SBSE-GC-MS and data mining

The new developed VOC analysis system includes several working steps, the core part being: the online VOC analysis by PTR-ToF-MS; offline analysis employing SBSE-GC-MS; and the data-mining strategy (Fig. S3). This combination together with the automated cuvette system was built in order to allow measurement and analysis of microbial volatiles, in particular, in a novel, comprehensive and dynamic manner. PTR-ToF-MS measurements covered the detection of especially small, polar compounds, whereas SBSE-GC-MS allowed for the detection of rather nonpolar, less volatile compounds and, moreover, facilitated the identification of compounds with equal masses (Tables S1, S3).

The real-time PTR-ToF-MS analysis allowed detecting development-dependent changes in the fVOCs emission from 12 fungal (and two control) samples sequentially (Figs 1, 2). When not been sampled, the fVOCs were allowed to accumulate for *c.* 70 min, which decreased the LOD. When a cuvette was sampled, the dilution of the fungal headspace with VOC-free air resulted in a continuous drop of the fVOC mixing ratios (Fig. 2c), which assisted in the separation of very volatile, nonpolar compounds from less volatile, polar and often oxygenated compounds. The signals of the latter were decaying more slowly during the sample period as a result of the greater 'stickiness' of these compounds onto the inner surface of the cuvette and the sample lines.

Shorter collection time allowed fast screening of a higher number of samples, whereas choosing fewer samples increased the time resolution.

The applied data-mining strategy facilitated the elucidation of the complex data reached by combining the two MS systems and the automated 14-cuvette platform. Within the present work we applied this new system combination to explore the fVOC patterns of four plant beneficial *Trichoderma* species.

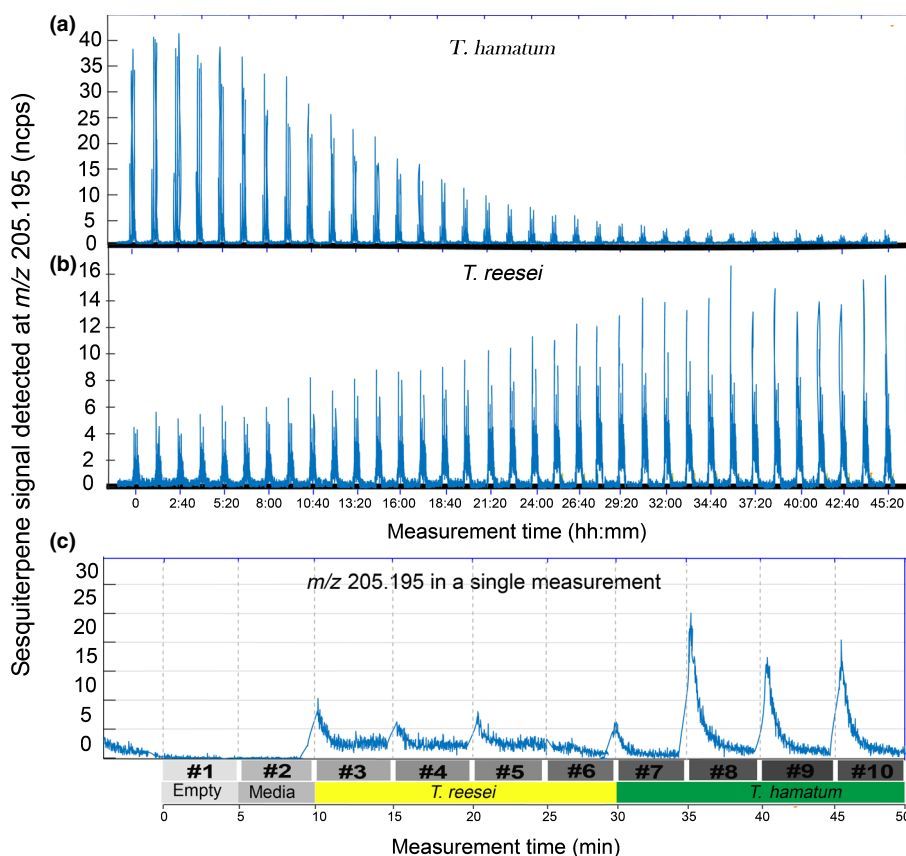
### Sesquiterpenes emission differ between *Trichoderma* species

The sesquiterpene detection capability exemplifies well the main features of the two applied MS systems. Our analysis with PTR-ToF-MS showed a strong sesquiterpene signal (*m/z* 205.195) in cultures of *T. hamatum* (Fig. 2a) and *T. reesei* (Fig. 2b), while it was very low in those of *T. harzianum* and *T. velutinum* (Fig. S4). We further detected a transient change of the sesquiterpene signal from *T. hamatum* and *T. reesei* over a measurement period of 2 d (Fig. 2). Zooming into a single measurement cycle, the differences in the transient course of the *m/z* 205.195 from the individual cuvettes can be observed (Fig. 2c). When the measurements started in an individual cuvette, a high signal was measured resulting from the preaccumulation. Owing to the gas exchange in the fungal headspace the signal then decreased, approximating a steady state by the end of the 5 min sampling time. The cumulative signal over the measurement period, therefore, corresponds to the overall amount of sesquiterpenes synthesized and released by the mycelia within a time period of *c.* 70 min.

Sesquiterpenes are a large class of isomeric terpenes having the same sum formula (C<sub>15</sub>H<sub>24</sub>), but differing in their chemical structure. Therefore, all nonfragmented sesquiterpenes are recorded in the PTR-ToF-MS as a unique ion signal bare of any structural information (Chadwick *et al.*, 2013; Fig. 2). Different fragmentation patterns of distinct sesquiterpenes could, in principle, aid in identifying some of them, but only as long as merely single sesquiterpenes are measured (Kim *et al.*, 2009) and no complex mixtures as shown herein. In order to identify the individual sesquiterpene isomers, we therefore performed a complementary VOC analysis by GC-MS (Fig. S3; Table 1). This combination allowed us to describe the dynamics of sesquiterpene emissions during the mycelial growth (by PTR-ToF-MS) and moreover to decipher their chemical structure (by GC-MS). As shown in Fig. 3, *T. hamatum* and *T. reesei* emitted a high number of sesquiterpenes, while *T. harzianum* and *T. velutinum* emitted only a few. The GC-MS measurements also showed that the emission patterns differed in different species: The sesquiterpene no. 1 ( $\beta$ -elemene), sesquiterpene no. 19 ( $\alpha$ -selinene) and sesquiterpene no. 24 (trans- $\gamma$ -bisabolene) together (63.01%) dominated the profiles of *T. hamatum* (Fig. 3f); sesquiterpene no. 4 ( $\alpha$ -cedrene), sesquiterpene no. 8 ( $\beta$ -cedrene) and sesquiterpene no. 6 ( $\beta$ -curcumene) together (52.69%) dominated the profile of *T. reesei* (Fig. 3g), while the profile of *T. harzianum* and *T. velutinum* had no distinct major component (Fig. 3e,h).

### Species-specific temporal changes of fVOC emissions

Proton transfer reaction-ToF-MS is a powerful online monitoring technique for studying volatile emissions, but had not yet, to our knowledge, been systematically applied to elucidate development-dependent changes in VOC profiles of different fungi. Our measurements demonstrated the potential of this analytical method for the detection of the dynamic VOC emission patterns. Our online measurements by PTR-ToF-MS showed four



**Fig. 2** Example of sesquiterpene signals acquired by proton transfer reaction-time-of-flight-MS (PTR-ToF-MS). Total sesquiterpenes were detected at mass  $m/z$  205.195. (a, b) Raw signals from *Trichoderma hamatum* (a) and *Trichoderma reesei* (b) over the entire measurement time of 48 h. (c) Detailed information for a single measurement cycle (sampling every 5 min from empty cuvette, medium only cuvette, four cuvettes containing *T. reesei* replicates and four cuvettes containing *T. hamatum* replicates). The dashed grey lines in (c) indicate the switch between the cuvettes. Before switching from one cuvette to the next, the tubing system was purged with zero air for 10 s (by switching to the completely empty cuvette 1) to get rid of the leftover volatiles from the last measurement. The switch caused a gap in measurements, visible in (c) as a rapid increase in signal between the samples.

different emission patterns in the *Trichoderma* species over the measurement period of 2 d: (1) 26 signals ( $m/z$ ) increased in intensity at the beginning of the measurements and then decreased again from the middle of the measurement period in the different fungi lines (cluster 1; Fig. 4a); (2) 81 signals whose intensity decreased over time (cluster 2; Fig. 4a); (3) 48 signals which increased continuously over time (cluster 3; Fig. 4a); and (4) 42 signals which fluctuated over the measurement period and could not be assigned to any of the three other clusters (cluster 4; Fig. 4a). The temporal emission profile of cluster 1 was typical for 65.4% of *T. harzianum*-emitted fVOCs, while for *T. hamatum* about half (46.9%) of the emitted compounds fitted into the emission profile of cluster 2, as did 28.4% of *T. harzianum* volatiles. The emission patterns of the two other *Trichoderma* species, *T. reesei* and *T. velutinum*, however, could be described by clusters 3 and 4 (Fig. 4b). However, the emission profile of a single compound could differ in different species: for example, the emission of a compound with mass  $m/z$  205.195 (total sesquiterpenes) showed different temporal patterns in different *Trichoderma* species (Fig. 4c).

Altogether, the emission patterns of the individual fVOCs differed clearly between the species. In *T. harzianum*, 32.7% of the

compounds had emission pattern 1 and 44.2% of the compounds had emission pattern 2, whereas only 23.1% of the compounds had emission patterns 3 and 4; in *T. hamatum*, 77.6% of the compounds belonged to cluster two, while only one compound belonged to cluster three; in *T. reesei* (cluster 1, 10.0%; cluster 2, 20.0%; cluster 3, 32.0%; cluster 4, 38.0%) and *T. velutinum* (cluster 1, 0.0%; cluster 2, 21.7%; cluster 3, 56.5%; cluster 4, 21.7%), the individual emission patterns were rather evenly distributed and only a few of those emitted followed cluster 1 (Fig. 4b).

Apparently, the emission patterns were not correlated with the moisture content inside the cuvettes. The relative humidity of the inlet air was set to 70% at 22°C at the beginning and was not further regulated throughout the experiment (and consequently through part of the developmental stages of the fungi samples). Lacking *in situ* air moisture sensors, we used the signal of the water cluster ( $\text{H}_2\text{O}-\text{H}_3\text{O}^+$ ) isotope detected at  $m/z$  39.033 with the PTR-ToF-MS as proxy for the relative air humidity and therefore for the overall moisture conditions inside the individual cuvettes. This signal was stable throughout the experiments in all cuvettes containing growth medium (i.e. cuvettes 2–14; cuvette 1 was completely empty (see Material and Methods section)).

**Table 1** The pros and cons of the two analyzing techniques, proton transfer reaction-time of flight-MS (PTR-ToF-MS) and GC-MS.

	PTR-ToF-MS	GC-MS
Pros	<p>Real-time monitoring at high mass resolution (c. 5000)</p> <p>Enables sum formula annotation</p> <p>High sensitivity with low limit of detection</p> <p>Excellent detection of low-molecular-weight, oxygenated and polar compounds</p>	<p>Enable longer accumulation time (offline)</p> <p>Compounds can be identified (NIST, Wiley library and Kovats retention index)</p>
Cons	<p>Limited accumulation time</p> <p>Identification only possible for some compounds with unique masses; no clear classification of mass fragments</p> <p>Isomers in general cannot be separated</p>	<p>Low time resolution at dynamic sampling</p> <p>Cumbersome procedures result in time-consuming analysis</p> <p>Polar and/or low-molecular-weight compounds are insufficiently trapped by most commonly used absorption materials (e.g. PDMS-Twister)</p> <p>Detection of more oxygenated compounds cumbersome without derivatization</p>

Owing to the sequential measurement of the cuvettes, resulting in cuvette flushing periods of 5 min every c. 70 min, the humidity of the growth medium seemed to be sufficient to maintain stable moisture conditions over the 2 d of experiment. The time trace of the water cluster ( $\text{H}_2\text{O}-\text{H}_3\text{O}^+$ ,  $m/z$  39.033) therefore fits into the temporal profile of cluster 4 in Fig. 4(a).

### Chemical diversity of VOCs emitted by *Trichoderma* species

To illustrate the chemical diversity of the individual *Trichoderma* species, we have clustered the volatile compounds into 11 chemical classes (monoterpenes, sesquiterpenes, sesquiterpene-alcohols, acyclic alkenes, alcohols, alkanes, aldehydes, ketones, acids, benzenoids and esters). Employing both, PTR-ToF-MS and GC-MS, a pronounced chemical diversity could be detected in the fVOC emissions (Fig. 5). However, the chemical class membership differed depending on the MS method applied. Mainly alcohol, aldehyde and ketone compounds were detected from the four *Trichoderma* species (accounting for 86.6% (*T. harzianum*), 96.8% (*T. hamatum*), 94.6% (*T. reesei*) and 94.0% (*T. velutinum*) of all the compounds; Fig. 5a) by PTR-ToF-MS, whereas the compounds detected by GC-MS were more diverse (Fig. 5b). A large part of the *T. hamatum* and *T. reesei* released compounds detected by GC-MS were sesquiterpenes, whereas those were only minor part of the compounds detected by PTR-ToF-MS (Fig. 5; Tables S1, S3). Also, benzenoids were detected by GC-MS but almost not at all by PTR-ToF-MS (Fig. 5). Actually, almost none of the compounds detected by PTR-ToF-MS

were found within the GC-MS chromatograms of the present study. These compounds detected by PTR-ToF-MS were also only very rarely reported in previous studies that explored fungal volatiles employing GC-MS (Tables S1, S3).

The PTR-ToF-MS and GC-MS have different capabilities to detect various compounds and compound classes (Table 1). Our data show that measurement with PTR-ToF-MS was ideally suited to detect the frequently occurring compounds (76.8% of the detected compounds were commonly shared by the four *Trichoderma* species), while GC-MS was more likely to detect species-specific compounds (4.5% commonly shared compounds) (Fig. S5). Based on the GC-MS dataset, sesquiterpenes were the dominant VOCs of *T. hamatum* and *T. reesei* (Fig. 5b). *Trichoderma reesei*, in particular, emitted many specific compounds that promoted the statistical separation of the emission profile from the three other *Trichoderma* species (Fig. 5c,d).

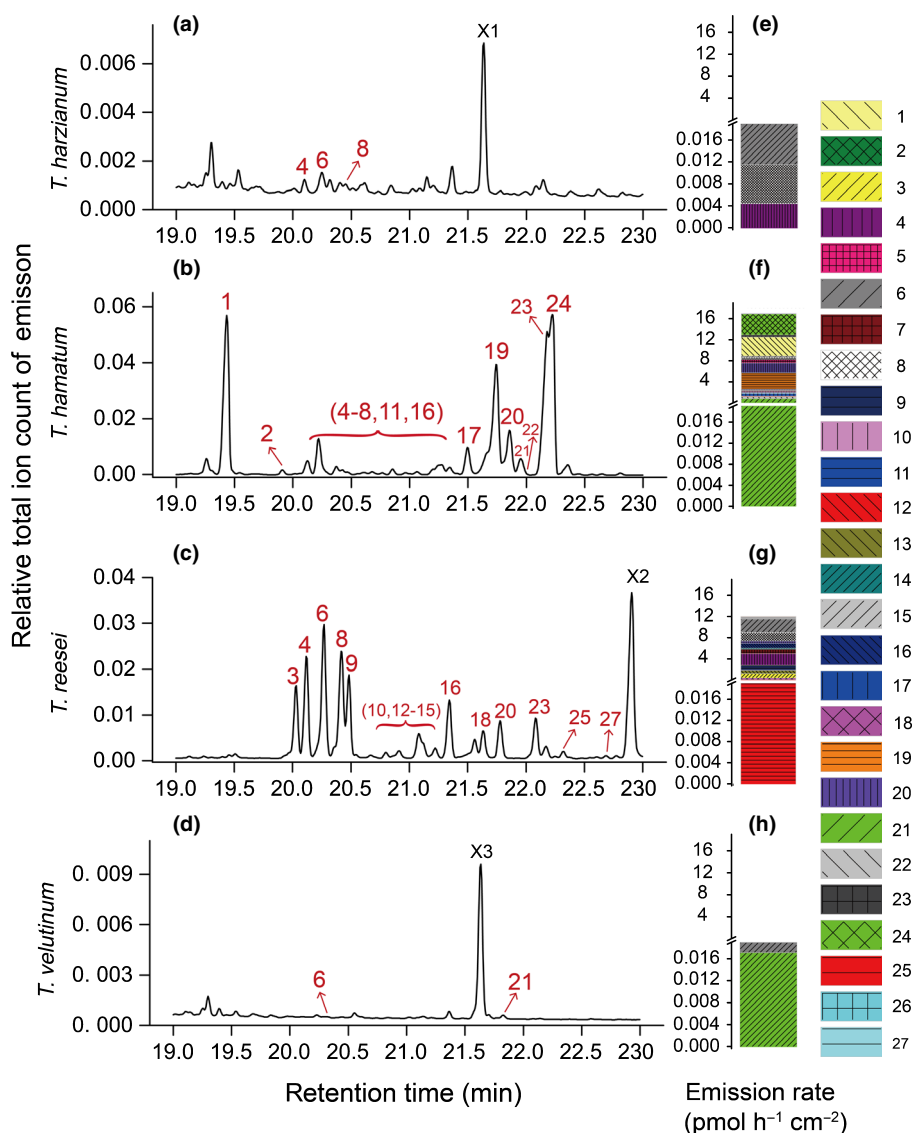
We performed a PCA to investigate the structure of the emission profile of the fungal odor profiles (combination of PTR-ToF-MS and GC-MS dataset; data are shown in Table S4). The biplot (Fig. 6a) illustrates that the first two components could explain 73.1% of the variance, with component 1 (48%) mainly separating *T. reesei* from the other three *Trichoderma* species. The component 2 (25%) separated mainly *T. hamatum* from the other three *Trichoderma* species. The two species *T. velutinum* and *T. harzianum* could also be separated by component 2 (Fig. 6a). The three most important VOCs responsible for the separation by component 1 is an unknown oxygenated sesquiterpene (o-SQT-3), as well as the two sesquiterpenes,  $\beta$ -curcumene and  $\alpha$ -muurolene. The most important VOCs for the separation in component 2 were the mass  $m/z$  135.116 ( $\text{C}_{10}\text{H}_{14} + \text{H}^+$ , p-cymene or o-cymene), selina-4(15),7(11)-diene and the mass  $m/z$  83.086 ( $\text{C}_6\text{H}_{10} + \text{H}^+$ , hexanal or 2,3-dimethyl-1,3-butadiene) (Fig. 6a).

Further, we used a supervised RF algorithm to determine the key compounds that characterized the *Trichoderma* species for each MS dataset. The top five predictors are illustrated in Fig. 6 (b). A heatmap (Fig. 6c) visualizes the distribution of predictors across the four species (Fig. 6c). The emission of a compound resulting in a signal at mass  $m/z$  71.049 ( $\text{C}_4\text{H}_6\text{O} + \text{H}^+$ , tentatively originating from either methyl vinyl ketone (MVK), methacrolein (MACR) or the dehydrated form of butyric acid),  $\beta$ -curcumene,  $\alpha$ -muurolene, unknown-o-SQT-3 and  $\beta$ -cedrene predicted *T. reesei*. *Trichoderma hamatum* was, by contrast, discriminated by the compounds with  $m/z$  135.116 (p-cymene or o-cymene),  $m/z$  45.034 ( $\text{C}_2\text{H}_4\text{O} + \text{H}^+$ , acetaldehyde) and selina-4(15),7(11)-diene. For *T. harzianum* and *T. velutinum*, no distinct predictor could be identified despite of the slight statistical separation by the PCA analysis (Fig. 6a).

### Discussion

Traditionally, fVOCs have often been overlooked partly as a result of analytical limitations (Morath *et al.*, 2012; Schmidt *et al.*, 2015; Li *et al.*, 2016). In the present study we demonstrated a platform to analyze fungal and other microbial VOCs efficiently and systemically. Previously Misztal *et al.*



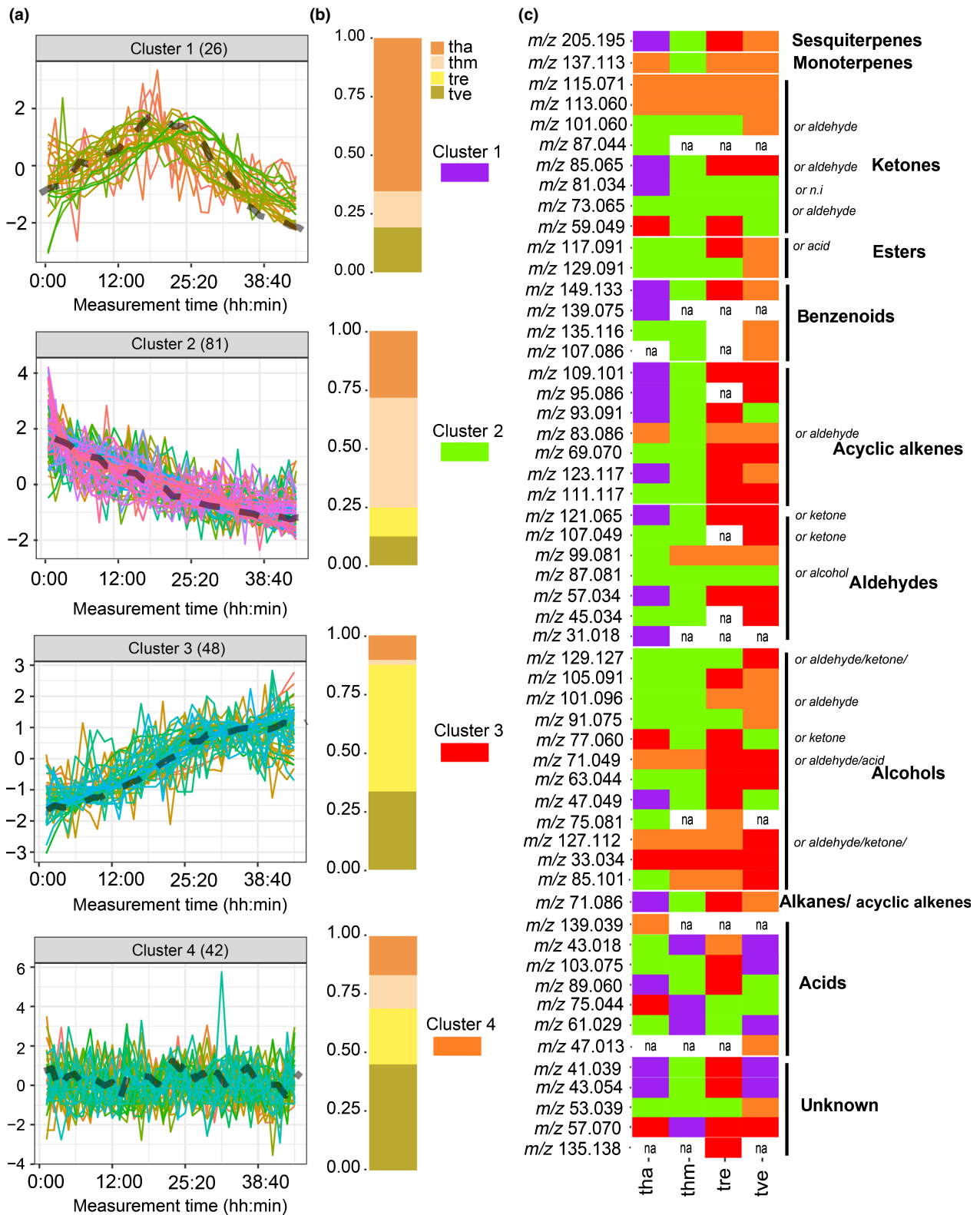


**Fig. 3** Sesquiterpene signals detected by GC-MS. (a–d) Relative total ion counts (TIC) of sesquiterpenes (SQTs) emitted by *Trichoderma harzianum* (a), *Trichoderma hamatum* (b), *Trichoderma reesei* (c) and *Trichoderma velutinum* (d). (e–h) Emission intensities (pmol h<sup>-1</sup> cm<sup>-2</sup>) of SQTs emitted by *T. harzianum* (e), *T. hamatum* (f), *T. reesei* (g) and *T. velutinum* (h). The dominating peaks X1 in *T. harzianum* and X3 in *T. velutinum* are butylhydroxytoluene (#35), whereas the dominating peak X2 in *T. reesei* is the SQT-alcohol nerolidol (#37). Color code: the numbers refer to the compounds in Supporting Information Table S1.

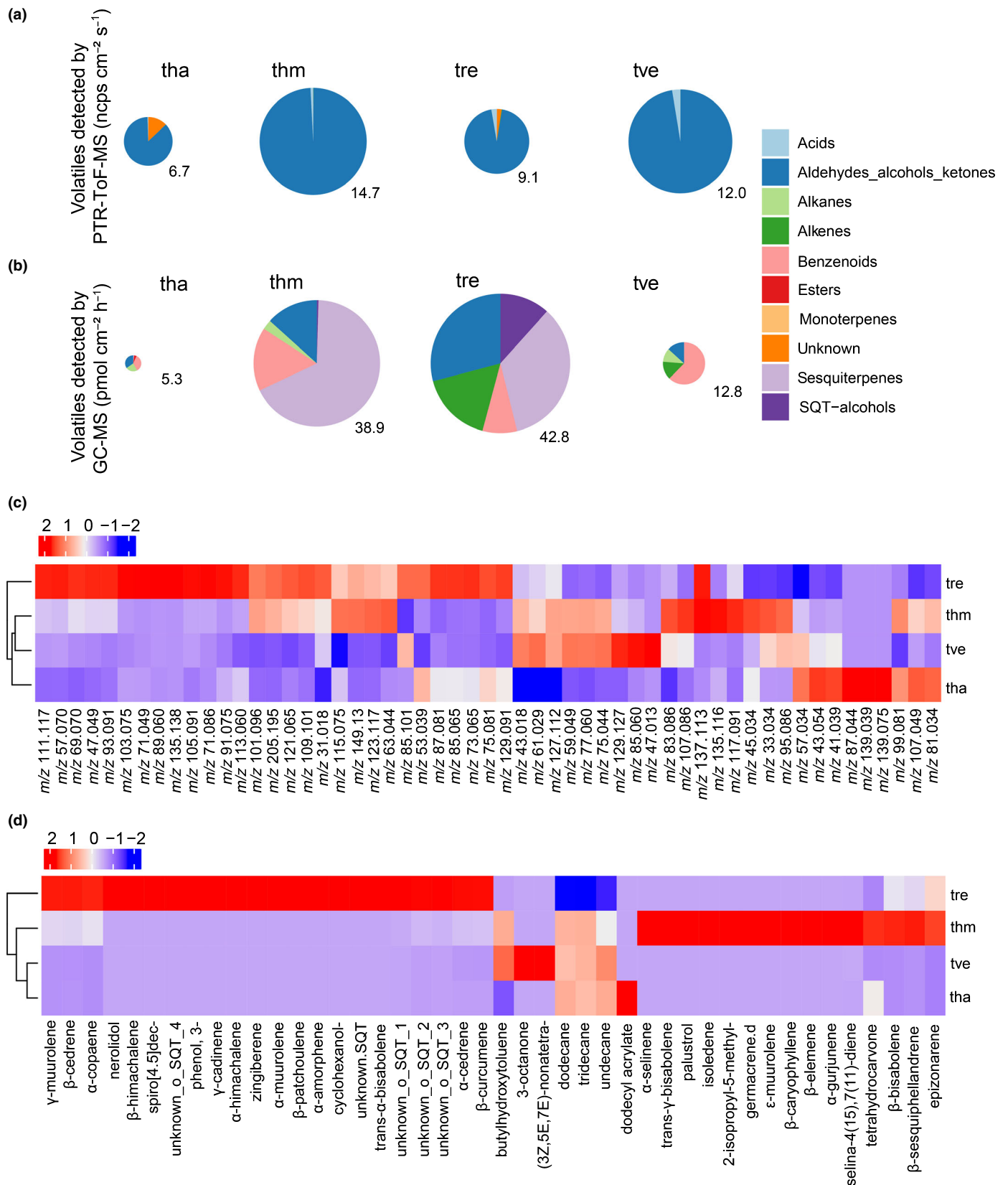
(2018) developed a cuvette system for microbial VOC measurements where, however, the VOC analysis was restricted to online MS. The present system takes advantage of the isomer speciation capability of GC-MS and the sensitivity and online measuring capability of PTR-ToF-MS. The detection sensitivity of the latter was additionally increased as fVOCs were allowed to accumulate in the headspace of the culture vessels as a result of the sequential switching between the cuvettes. Combination of the two MS systems with the cuvette system allowed us to comprehensively analyze the fungal volatilomes of the four *Trichoderma* species. The platform is completed by a data-mining approach enabling analysis of complex datasets. Together, the developed system allows rapid, as well as long-term, microbial/fungal VOC analyses.

To test the performance of the platform, we investigated development-dependent changes in fVOC emission of four fast-growing *Trichoderma* species over 48 h. The measurements revealed four completely different emission patterns for the four species. Using the data-mining approach, the emission patterns of each individual compound were visualized. The analysis procedure and the results prove that combination of all properties of the new system significantly enhances the accuracy and efficiency of VOC measurements from fungi (and for microorganisms in general). It also enables an analysis of development-dependent emission processes. The revealing of comprehensive fVOC pattern forms the necessary basis for further phenotyping and analysis of fungal chemical diversity. In the present work, we analyzed long-term changes in VOC emission, but alternatively, if the collection

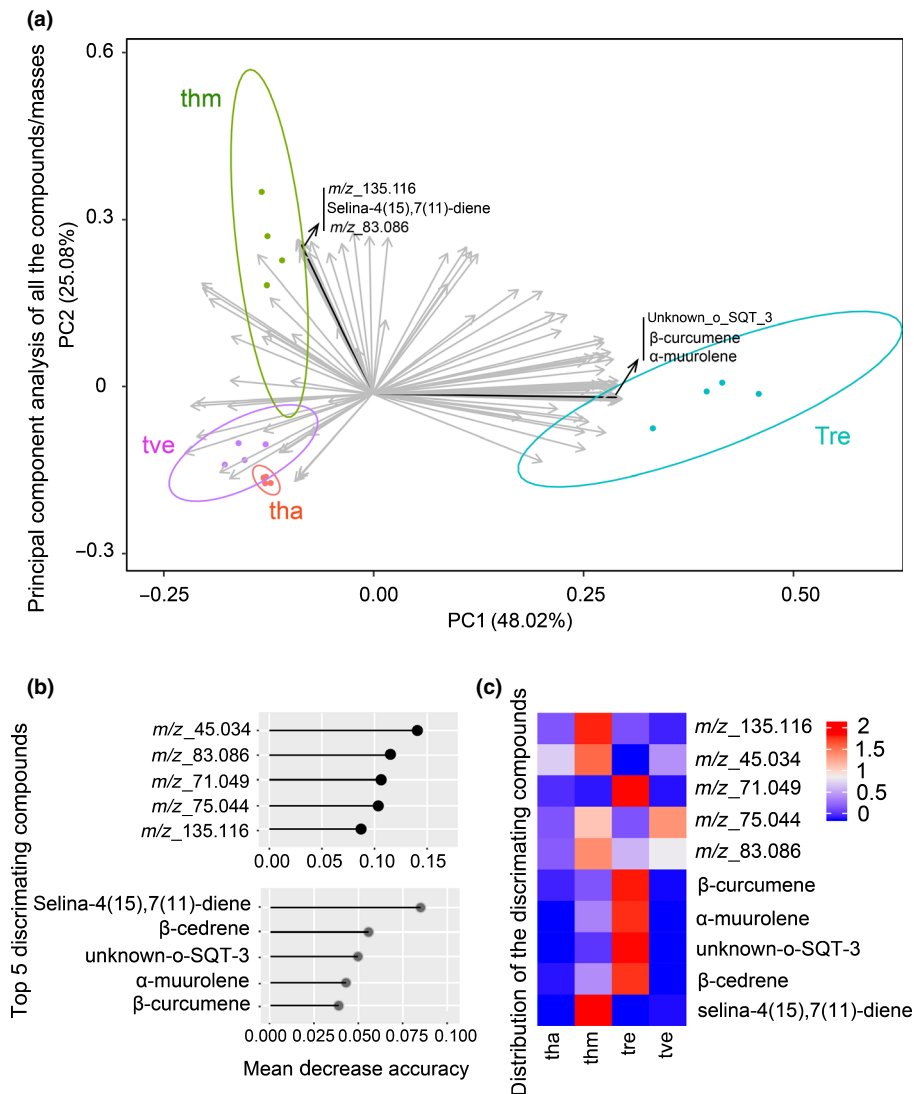




**Fig. 4** Time series of detected compounds (*m/z*) emitted by the four *Trichoderma* species. (a) Time series emission pattern of all the detected masses. Numbers in brackets indicate the numbers of compounds (masses) within a cluster sharing the same emission pattern. Black dotted lines indicate the median of the corresponding emission pattern. Note that the water cluster ( $H_2O-H_3O^+$ ) isotope signal at *m/z* 39.033, correlating with the relative humidity in the cuvettes, showed a similar pattern as cluster 4. (b) Relative percentages of masses contributing to an individual pattern (tha, *T. harzianum*; thm, *T. hamatum*; tre, *T. reesei*; tve, *T. velutinum*). (c) Emission patterns of the individual masses (purple cells denote clusters patterns 1, green cells denote clusters patterns 2, red cells denote clusters patterns 3, orange cells denote clusters patterns 4; na, not detectable).



**Fig. 5** (a, b) Chemical diversity of fungal volatile organic compounds based on proton transfer reaction-time-of-flight-MS (PTR-ToF-MS) (a) and GC-MS (b). Pie chart area indicates the total emission intensity (adjunct values). (c, d) Heatmap visualizing the emission intensity of individual fungal volatile organic compounds (fVOCs) detected by PTR-ToF-MS (c) and GC-MS (d). Data are standardized to have means of 0 and variance of 1 before visualization. Euclidean distance was used to cluster *Trichoderma* species. tha, *T. harzianum*; thm, *T. hamatum*; tre, *T. reesei*; tve, *T. velutinum*.



**Fig. 6** (a) Principal components analysis (PCA) biplot was used to explore the structure of the emission profiles of *Trichoderma* species (tha, *T. harzianum*; thm, *T. hamatum*; tre, *T. reesei*; tve, *T. velutinum*) in an unsupervised manner. Here we used merged data of all the masses and compounds detected by proton transfer reaction-time-of-flight-MS (PTR-ToF-MS) and GC-MS. Data were z-score-standardized to remove the effect of different units and scales. The masses/compounds indicated by the black vectors are the top six compounds contributing to the first two components. (b) Random forest (RF) analysis was used to discover the top five compounds discriminating the *Trichoderma* species. Masses/compounds were ranked by the mean decrease of accuracy in the model. (c) A heatmap was used to visualize the distribution of all individual predictors in the four *Trichoderma* species.

time were reduced to a few hours, a high number of samples could be run within a short period of time. On the other hand, when a smaller number of samples is chosen for analysis, a high time resolution of VOC emission pattern can be reached.

In the current study, the PTR-ToF-MS detected the sum signal of all sesquiterpenes (at  $m/z$  205.195 and some other fragment  $m/z$ ). By contrast, the SBSE-GC-MS analysis revealed up to 27 individual sesquiterpenes from the four *Trichoderma* spp. As SBSE-GC-MS is an offline method, the integral analysis time using GC-MS cannot be directly compared with the measurement intervals of the semi-online technique (i.e. PTR-ToF-MS). However, the combination of both analytical techniques facilitated the recovery of a virtually complete emission pattern – the volatilome – of the investigated fungi. It turned out that the

PTR-ToF-MS-detected VOCs were shared very commonly by all four *Trichoderma* species, whereas the GC-MS analysis enabled us to identify and quantify more species-specific compounds, discriminating, for example, the two species *T. hamatum* and *T. reesei*. The detected species-specific VOC profiles here are in accordance with previous studies describing individual *Trichoderma* species according to their VOCs (Guo *et al.*, 2019). So far, an ecological function has been described only for a few of the *Trichoderma* VOCs; however, these few have been shown to transmit remarkable effects on the plant performance (Hung *et al.*, 2013; Kottb *et al.*, 2015; Lee *et al.*, 2016, 2019). For example, 6-pentyl-2H-pyran-2-one (6PP) increased the defense of *Arabidopsis thaliana* with parallel reduced growth (Kottb *et al.*, 2015) and, recently, *Trichoderma* VOCs were shown to induce

expression of genes involved in *Arabidopsis* systemic resistance induction (Estrada-Rivera *et al.*, 2019). Our GC-MS analysis revealed a large chemical diversity of the odors of the different *Trichoderma* species. Interestingly, previously large adjustments of the emission patterns were shown when *Trichoderma* was grown in the presence of other fungi (Guo *et al.*, 2019). The high chemical diversity as well as the adjustment of emissions to the changing environment both suggest important ecological functions for these compounds (Guo *et al.*, 2019). The present results revealed strong species dependency, especially for sesquiterpenes. Although not yet that well established in fungi, sesquiterpenes are known to act as semiochemicals in plant biotic interactions influencing plant development (Ditengou *et al.*, 2015), attract insect pollinators (Rasmann *et al.*, 2005), induce plant resistance (Na *et al.*, 2019) and combat plant pathogens (Schalchli *et al.*, 2015, 2016). For the sesquiterpene  $\beta$ -caryophyllene from *Trichoderma* spp., a growth-promoting function was shown (Hung *et al.*, 2013).

The sesquiterpene emission patterns showed high chemical diversity between the species, and we also revealed four completely differently fluctuating emission patterns over the 48 h measurement period. Many of other compounds, such as  $m/z$  71.086 (cyclopentane or pentene) and  $m/z$  93.091 (toluene or bicyclo[3.2.0]hepta-2,6-diene), also showed species-specific, temporally fluctuating emission patterns. Although in recent years, a remarkably growing number of studies have focused on the determination of VOCs from fungi (Hung *et al.*, 2015; Dickschat, 2017), only a few studies have explored temporal changes of fungal emission patterns (Lee *et al.*, 2015; Weigl *et al.*, 2017; Misztal *et al.*, 2018). Weigl *et al.* (2017) and Lee *et al.* (2015) took the first steps to analyze age-dependent changes of fungal VOC emission patterns: Weigl *et al.* (2017) measured the weekly emission changes from *Fusarium* spp. and *Alternaria* spp, whereas Lee *et al.* (2015) reported age-dependent VOC emissions from 5- and 14-day-old *T. atroviride*. Khomenko *et al.* (2017), who analyzed the yeast VOCs via PTR-ToF-MS, demonstrated temporal changes in VOC emission during the yeast colony growth. More recently, using a similar approach employing PTR-ToF-MS, Misztal *et al.* (2018) reported on the emission patterns of selected bacterial and fungal species under various abiotic and biotic environmental conditions. Their results show, except for variation between taxa, that microbial VOC emissions are also dependent on substrate type, biotic environment, growth phase and life cycle. Sesquiterpene emission, in particular, seems to vary strongly according to the growth environment (González-Pérez *et al.*, 2018; Guo *et al.*, 2019; Misztal *et al.*, 2018). Taking this previous knowledge and the present results together, it seems that several fungal species may alter especially sesquiterpene release when adjusting to the surrounding environment. However, the underlying principles behind the differently behaving emission patterns remain to be elucidated. Fungal VOCs may indeed also have some other, completely different and not yet understood ecological functions in the interorganismic interactions, as suggested in the review by Kramer & Abraham (2012). Moreover, although we talk here about fungal VOCs, we cannot completely rule out the possibility that the investigated axenic cultures

involved bacterial endosymbionts (Uehling *et al.*, 2017) which might have influenced the performance of the fungi or even emitted volatiles themselves.

Contrary to the GC-MS analysis, the compounds detected by the PTR-ToF-MS measurements were mostly less complex, suggesting an origin in primary rather than secondary metabolism. To date, an ecological function has been described for only a few of these compounds and, astonishingly, most of these compounds detected by PTR-ToF-MS have never been before reported for *Trichoderma* species. In addition to the aspects of developing a high-throughput platform for the VOC emission analysis from fungi or other organisms, we propose a basic methodology for data mining of VOCs from different organisms. This approach, based on multivariate statistics and machine learning (RF), significantly facilitates the decoding of the chemical diversity of volatile compounds from fungi and paves the way for the studies on fVOC-mediated fungus-fungus and fungus-plant interactions. Machine learning helped us to determine the characteristic VOCs for different species. This approach revealed that *Trichoderma* compounds detected by PTR-ToF-MS, such as the ones detected at  $m/z$  71.049 (tentatively MVK, MACR or a butyric acid fragment) and  $m/z$  45.034 (acetaldehyde), were crucial discriminators of *T. reesei* and *T. hamatum*, respectively. Previous studies have shown that acetaldehyde can inhibit the growth of black mold, *Aspergillus niger* (Stotzky *et al.*, 1976). Some of the other detected compounds, such as ethanol ( $m/z$  47.049), acetone ( $m/z$  59.050) and 1-octen-3-ol/3-octanone ( $m/z$  129.127), were also shown to harbor antifungal activity (Stotzky *et al.*, 1976; Toffano *et al.*, 2017; Baiyee *et al.*, 2019; Lee *et al.*, 2019). Both 1-octen-3-ol ( $m/z$  129.127) and 2-octenal/1-octen-3-one ( $m/z$  127.112) were also shown to have other crucial ecological functions, such as regulation of plant and seed growth (Kishimoto *et al.*, 2007; Lee *et al.*, 2019) and attraction of insects (Pierce *et al.*, 1991; Chaiphongpachara *et al.*, 2019). Nonetheless, the biological functions of most of the other compounds emitted by *Trichoderma* spp. and detected by PTR-ToF-MS remain so far unknown.

Taken together, and considering the analysis of chemical diversity, PTR-ToF-MS and GC-MS (in the present setup) seem to be suitable, in different ways, to distinguish the individual *Trichoderma* species from each other, as they have different compound detection preferences. While the PTR-ToF is a convenient method for detecting polar, shorter-chained volatile compounds (up to *c.*  $m/z$  300), the employment of the SBSE-GC-MS is better suited to the separation of nonpolar, long-chained compounds. Together the two complementary techniques allowed us to detect a much wider spectrum of VOCs than using one MS method alone. A future addition will be the integration of an infrared gas analyzer for CO<sub>2</sub> and H<sub>2</sub>O acquisition in the outlet gas flow of the cuvette system. This enables measurements of humidity and fungal respiration rates, which will allow a better correlation of VOC emission rates with the metabolic activity of the fungi.

Moreover, not only because of the limited number of fungal species that have been systematically investigated for their odor profile to date, but also based on the present knowledge that the



fungal physiology, as well as biotic and abiotic environments, seems to drastically alter the pattern of fVOCs released (Schmidt *et al.*, 2015; Nieto-Jacobo *et al.*, 2017; Guo *et al.*, 2019), it can be assumed that a large number of volatile compounds are still undiscovered (Li *et al.*, 2016). Also, the present study reveals 52 volatiles (34 volatiles from PTR-ToF-MS and 18 from GC-MS) that have not been previously reported from *Trichoderma* species. Recently, co-cultivation systems of fungi and plants have been increasingly used to study the biological effects of fVOCs on plant growth and fitness (Ditengou *et al.*, 2015; Kottb *et al.*, 2015; Lahrmann *et al.*, 2015; Ameztoy *et al.*, 2019; García-Gómez *et al.*, 2019; Moisan *et al.*, 2019). None of these studies report changes in the emission pattern of a fungi–plant system over time (e.g. the over pre-establishment phase until symbiosis). This can be changed in future by applying analyses platforms such as presented here. So far, only in one study has the effect of fVOCs from two different ages of fungi on plant growth been compared (Lee *et al.*, 2015). Indeed, Lee and colleagues revealed a fungal age-dependent response of plants to the fVOCs, alleviating the importance of timing in plant–fungi interactions. Our results also suggest that fungal age matters and can lead to completely different results of interactions. Fundamental technical improvements are necessary to better analyze the physiological processes of formation and release of fVOCs, for example in relation to abiotic and biotic environments. Even basic experimental conditions such as CO<sub>2</sub> concentration, relative air humidity and water availability can have drastic implications for the experimental results (Dannemiller *et al.*, 2017). Future developmental stages of our platform will, therefore, incorporate the cuvette-wise regulation of relative air humidity of the inlet air. The control of individual CO<sub>2</sub> concentrations in the inlet air of each individual cuvette is desirable, but a great technical challenge, as individual dilutions would have to be produced for each cuvette using individual mass flow controllers.

Further recordings of real-time emissions from fungi, both alone and in interaction with other organisms, will enhance our understanding of bioactive VOCs and their functions. It will be particularly interesting to monitor real-time changes in fungi or other microbes growing towards other microbial or plant species. High-throughput techniques, such as those described here, will help to accelerate the research on fVOCs. This platform can be used not only for chemotyping analysis of VOC emissions from individual fungal species, but also for co-cultivation experiments with fungi, microorganisms and small plants.

## Acknowledgements







The authors sincerely thank Monika Schmoll (AIT Austrian Institute of Technology GmbH, Austria) for providing the *Trichoderma* strains for the study. The development and setup of the fungal VOC phenotyping platform was done within the German Plant Phenotyping Network (Deutsches Pflanzen Phänotypisierungsnetzwerk, DPPN), funded by the Federal Ministry for Education and Research (Bundesministerium für Bildung und Forschung, BMBF, Förderkennzeichen 031A053A/B/C). YG

was supported by a fellowship of the China Scholarship Council (CSC).

## Author contributions

YG, J-PS, JPB and MR designed the study. YG, WJ, AG and FA constructed the automated cuvette system. YG performed the experiments and analyzed the data with help from WJ. YG and WJ contributed equally. YG prepared the figures and, together with MR, wrote the manuscript. All authors contributed to data analysis and interpretation of the findings, and edited and approved the manuscript. YG and WJ contributed equally to this work.

## ORCID

J. Philipp Benz  <https://orcid.org/0000-0001-5361-4514>  
 Andrea Ghirardo  <https://orcid.org/0000-0003-1973-4007>  
 Yuan Guo  <https://orcid.org/0000-0002-5904-6113>  
 Werner Jud  <https://orcid.org/0000-0003-4267-0435>  
 Maaria Rosenkranz  <https://orcid.org/0000-0002-1421-112X>  
 Jörg-Peter Schnitzler  <https://orcid.org/0000-0002-9825-867X>

## References

- Adams RI, Lymperopoulou DS, Misztal PK, De Cassia Pessotti R, Behie SW, Tian Y, Goldstein AH, Lindow SE, Nazaroff WW, Taylor JW *et al.* 2017. Microbes and associated soluble and volatile chemicals on periodically wet household surfaces. *Microbiome* 5: 128. doi: 10.1186/s40168-017-0347-6.
- Ameztoy K, Baslam M, Sánchez-López ÁM, Muñoz FJ, Bahaji A, Almagro G, García-Gómez P, Baroja-Fernández E, De Diego N, Humpalik JF. 2019. Plant responses to fungal volatiles involve global post-translational thiol redox proteome changes that affect photosynthesis. *Plant, Cell & Environment* 42: 2627–2644.
- Baiyee B, Pornsuriya C, Ito S-i, Sunpapao A. 2019. *Trichoderma spirale* T76-1 displays biocontrol activity against leaf spot on lettuce (*Lactuca sativa* L.) caused by *Corynespora cassiicola* or *Curvularia aerea*. *Biological Control* 129: 195–200.
- Bicchi C, Liberto E, Cordero CEI, Sgorbini B, Rubiolo P. 2009. Stir bar sorptive extraction (SBSE) and headspace sorptive extraction (HSSE): an overview. *LCGC North America* 27: 376–391.
- Breiman L. 2001. Random forests. *Machine Learning* 45: 5–32.
- Bzdok D, Altman N, Krzywinski M. 2018. Statistics versus machine learning. *Nature Methods* 15: 233.
- Calvo AM, Wilson RA, Bok JW, Keller NP. 2002. Relationship between secondary metabolism and fungal development. *Microbiology and Molecular Biology Reviews* 66: 447–459.
- Camacho DM, Collins KM, Powers RK, Costello JC, Collins JJ. 2018. Next-generation machine learning for biological networks. *Cell* 173: 1581–1592.
- Chadwick M, Trewin H, Gawthrop F, Wagstaff C. 2013. Sesquiterpenoids lactones: benefits to plants and people. *International Journal of Molecular Sciences* 14: 12780–12805.
- Chaiphongpachara T, Chitsawaeng C, Chansukh KK. 2019. Comparison of the larvicidal and adult mosquito attractant efficacy between straw mushroom *Volvariella volvacea* extract and octenol (1-octen-3-ol) on mosquito vectors (Diptera: Culicidae). *Journal of Applied Pharmaceutical Science* 9: 095–099.
- Dannemiller KC, Weschler CJ, Peccia J. 2017. Fungal and bacterial growth in floor dust at elevated relative humidity levels. *Indoor Air* 2: 354–363.
- Dickschat JS. 2017. Fungal volatiles—a survey from edible mushrooms to moulds. *Natural Product Reports* 34: 310–328.

- Ditengou FA, Müller A, Rosenkranz M, Felten J, Lasok H, Van Doorn MM, Legué V, Palme K, Schnitzler J-P, Polle A. 2015. Volatile signalling by sesquiterpenes from ectomycorrhizal fungi reprogrammes root architecture. *Nature Communications* 6: 6279.
- Druzhinina IS, Seidl-Seiboth V, Herrera-Estrella A, Horwitz BA, Kenerley CM, Monte E, Mukherjee PK, Zeilinger S, Grigoriev IV, Kubicek CP. 2011. *Trichoderma*: the genomics of opportunistic success. *Nature Reviews Microbiology* 9: 749.
- Estrada-Rivera M, Rebollo-Prudencio OG, Pérez-Robles DA, del Carmen Rocha-Medina M, del Carmen González-López M, Casas-Flores S. 2019. *Trichoderma* histone deacetylase HDA-2 modulates multiple responses in *Arabidopsis*. *Plant Physiology* 179: 1343–1361.
- Farneti B, Khomenko I, Cappellin L, Ting V, Romano A, Biasioli F, Costa G, Costa F. 2015. Comprehensive VOC profiling of an apple germplasm collection by PTR-ToF-MS. *Metabolomics* 11: 838–850.
- García-Gómez P, Almagro G, Sánchez-López ÁM, Bahaji A, Ameztoy K, Ricarte-Bermejo A, Baslam M, Antolín MC, Urdiain A, López-Belchi MD. 2019. Volatile compounds other than CO<sub>2</sub> emitted by different microorganisms promote distinct posttranscriptionally regulated responses in plants. *Plant, Cell & Environment* 42: 1729–1746.
- Ghirardo A, Heller W, Fladung M, Schnitzler JP, Schroeder H. 2012. Function of defensive volatiles in pedunculate oak (*Quercus robur*) is tricked by the moth *Tortrix viridana*. *Plant, Cell & Environment* 35: 2192–2207.
- Ghirardo A, Xie J, Zheng X, Wang Y, Grote R, Block K, Wildt J, Mentel T, Kiendler-Scharr A, Hallquist M, et al. 2016. Urban stress-induced biogenic VOC emissions and SOA-forming potentials in Beijing. *Atmospheric Chemistry and Physics* 16: 2901–2920.
- González-Pérez E, Ortega-Amaro MA, Salazar-Badillo FB, Bautista E, Douterlungne D, Jiménez-Bremont JF. 2018. The *Arabidopsis*-*Trichoderma* interaction reveals that the fungal growth medium is an important factor in plant growth induction. *Scientific Reports* 8: 16427.
- Graus M. 2005. *Application of proton-transfer-reaction mass spectrometry: research on biosynthetic pathways to VOC formation and emission by deciduous trees using <sup>13</sup>C-labelling*. PhD thesis, University of Innsbruck, Innsbruck, Austria.
- Graus M, Müller M, Hansel A. 2010. High resolution PTR-TOF: quantification and formula confirmation of VOC in real time. *Journal of the American Society for Mass Spectrometry* 21: 1037–1044.
- Guo Y, Ghirardo A, Weber B, Schnitzler J-P, Benz JP, Rosenkranz M. 2019. *Trichoderma* species differ in their volatile profiles and in antagonism toward ectomycorrhiza *Laccaria bicolor*. *Frontiers in Microbiology* 10: 891.
- Guzmán-Guzmán P, Porras-Troncoso MD, Olmedo-Monfil V, Herrera-Estrella A. 2018. *Trichoderma* species: versatile plant symbionts. *Phytopathology* 109: 6–16.
- Harman GE. 2011. *Trichoderma*—not just for biocontrol anymore. *Phytoparasitica* 39: 103–108.
- Hung R, Lee S, Bennett JW. 2013. *Arabidopsis thaliana* as a model system for testing the effect of *Trichoderma* volatile organic compounds. *Fungal Ecology* 6: 19–26.
- Hung R, Lee S, Bennett JW. 2015. Fungal volatile organic compounds and their role in ecosystems. *Applied Microbiology and Biotechnology* 99: 3395–3405.
- Hunter EPL, Lias SG. 1998. Evaluated gas phase basicities and proton affinities of molecules: an update. *Journal of Physical and Chemical Reference Data* 27: 413–656.
- Infantino A, Costa C, Aragona M, Reverberi M, Taiti C, Mancuso S. 2017. Identification of different *fusarium* spp. through mVOCs profiling by means of proton-transfer-reaction time-of-flight (PTR-TOF-MS) analysis. *Journal of Plant Pathology* 99: 663–669.
- Insam H, Seewald MS. 2010. Volatile organic compounds (VOCs) in soils. *Biology and Fertility of Soils* 46: 199–213.
- Jud W, Winkler JB, Niederbacher B, Niederbacher S, Schnitzler JP. 2018. Volatilomics: a non-invasive technique for screening plant phenotypic traits. *Plant Methods* 14: 1–18.
- Kanchiswamy CN, Malnoy M, Maffei ME. 2015. Bioprospecting bacterial and fungal volatiles for sustainable agriculture. *Trends in Plant Science* 20: 206–211.
- Karlsson I, Boström H. 2014. Handling sparsity with random forests when predicting adverse drug events from electronic health records. International conference on healthcare informatics: IIEEE, 17–22.
- Kassambara A, Mundt F. 2017. Factoextra: extract and visualize the results of multivariate data analyses. R package version 1.0. 4.
- Kataoka H, Lord HL, Pawliszyn J. 2000. Applications of solid-phase microextraction in food analysis. *Journal of Chromatography A* 880: 35–62.
- Khomenko I, Stefanini I, Cappellin L, Cappelletti V, Franceschi P, Cavalieri D, Märk TD, Biasioli F. 2017. Non-invasive real time monitoring of yeast volatiles by PTR-ToF-MS. *Metabolomics* 13: 118.
- Kim S, Karl T, Helmig D, Daly R, Rasmussen R, Guenther A. 2009. Measurement of atmospheric sesquiterpenes by proton transfer reaction-mass spectrometry (PTR-MS). *Atmospheric Measurement Techniques* 2: 99–112.
- Kishimoto K, Matsui K, Ozawa R, Takabayashi J. 2007. Volatile 1-octen-3-ol induces a defensive response in *Arabidopsis thaliana*. *Journal of General Plant Pathology* 73: 35–37.
- Kottb M, Gigolashvili T, Großkinsky DK, Piechulla B. 2015. *Trichoderma* volatiles effecting *Arabidopsis*: from inhibition to protection against phytopathogenic fungi. *Frontiers in Microbiology* 6: 995.
- Kramer R, Abraham W-R. 2012. Volatile sesquiterpenes from fungi: what are they good for? *Phytochemistry Reviews* 11: 15–37.
- Kubicek CP, Herrera-Estrella A, Seidl-Seiboth V, Martinez DA, Druzhinina IS, Thon M, Zeilinger S, Casas-Flores S, Horwitz BA, Mukherjee PK. 2011. Comparative genome sequence analysis underscores mycoparasitism as the ancestral life style of *Trichoderma*. *Genome Biology* 12: R40.
- Kuhn M. 2008. Building predictive models in R using the caret package. *Journal of Statistical Software* 28: 1–26.
- Lahrmann U, Strehmel N, Langen G, Frerigmann H, Leson L, Ding Y, Scheel D, Herklotz S, Hilbert M, Zuccaro A. 2015. Mutualistic root endophytism is not associated with the reduction of saprotrophic traits and requires a noncompromised plant innate immunity. *New Phytologist* 207: 841–857.
- Lee S, Behringer G, Hung R, Bennett J. 2019. Effects of fungal volatile organic compounds on *Arabidopsis thaliana* growth and gene expression. *Fungal Ecology* 37: 1–9.
- Lee S, Hung R, Yap M, Bennett JW. 2015. Age matters: the effects of volatile organic compounds emitted by *Trichoderma atroviride* on plant growth. *Archives of Microbiology* 197: 723–727.
- Lee S, Yap M, Behringer G, Hung R, Bennett JW. 2016. Volatile organic compounds emitted by *Trichoderma* species mediate plant growth. *Fungal Biology and Biotechnology* 3: 7.
- Lemfack MC, Gohlke B-O, Toguem SMT, Preissner S, Piechulla B, Preissner R. 2017. mVOC 2.0: a database of microbial volatiles. *Nucleic Acids Research* 46: D1261–D1265.
- Li N, Alfiky A, Vaughan MM, Kang S. 2016. Stop and smell the fungi: fungal volatile metabolites are overlooked signals involved in fungal interaction with plants. *Fungal Biology Reviews* 30: 134–144.
- Li N, Alfiky A, Wang W, Islam M, Nourollahi K, Liu X, Kang S. 2018. Volatile compound-mediated recognition and inhibition between *Trichoderma* biocontrol agents and *Fusarium oxysporum*. *Frontiers in Microbiology* 9: 2614.
- Li T, Holst T, Michelsen A, Rinnan R. 2019. Amplification of plant volatile defence against insect herbivory in a warming Arctic tundra. *Nature Plants* 5: 568.
- Lindinger W, Jordan A. 1998. Proton-transfer-reaction mass spectrometry (PTR-MS): on-line monitoring of volatile organic compounds at pptv levels. *Chemical Society Reviews* 27: 347–375.
- Mancuso S, Taiti C, Bazihizina N, Costa C, Menesatti P, Giagnoni L, Arenella M, Nannipieri P, Renella G. 2015. Soil volatile analysis by proton transfer reaction-time of flight mass spectrometry (PTR-TOF-MS). *Applied Soil Ecology* 86: 182–191.
- Marcillo A, Jakimovska V, Widdig A, Birkemeyer C. 2017. Comparison of two common adsorption materials for thermal desorption gas chromatography–mass spectrometry of biogenic volatile organic compounds. *Journal of Chromatography A* 1514: 16–28.
- Matysik S, Herbarth O, Mueller A. 2009. Determination of microbial volatile organic compounds (MVOCs) by passive sampling onto charcoal sorbents. *Chemosphere* 76: 114–119.
- Maynard DS, Bradford MA, Covey KR, Lindner D, Glaeser J, Talbert DA, Tinker PJ, Walker DM, Crowther TW. 2019. Consistent trade-offs in fungal trait expression across broad spatial scales. *Nature Microbiology* 4: 846.

- Mhlongo MI, Piater LA, Madala NE, Labuschagne N, Dubery IA. 2018. The chemistry of plant–microbe interactions in the rhizosphere and the potential for metabolomics to reveal signaling related to defense priming and induced systemic resistance. *Frontiers in Plant Science* 9: 112.
- Misztal PK, Lympelopoulou DS, Adams RI, Scott RA, Lindow SE, Bruns T, Taylor JW, Uehling J, Bonito G, Vilgalys R. 2018. Emission factors of microbial volatile organic compounds from environmental bacteria and fungi. *Environmental Science & Technology* 52: 8272–8282.
- Moisan K, Cordovez V, van de Zande EM, Raaijmakers JM, Dicke M, Lucas-Barbosa D. 2019. Volatiles of pathogenic and non-pathogenic soil-borne fungi affect plant development and resistance to insects. *Oecologia* 190: 589–604.
- Mondello L, Casilli A, Tranchida PQ, Dugo G, Dugo P. 2005. Comprehensive two-dimensional gas chromatography in combination with rapid scanning quadrupole mass spectrometry in perfume analysis. *Journal of Chromatography A* 1067: 235–243.
- Morath SU, Hung R, Bennett JW. 2012. Fungal volatile organic compounds: a review with emphasis on their biotechnological potential. *Fungal Biology Reviews* 26: 73–83.
- Müller A, Faubert P, Hagen M, Zu Castell W, Polle A, Schnitzler JP, Rosenkranz M. 2013. Volatile profiles of fungi—chemotyping of species and ecological functions. *Fungal Genetics and Biology* 54: 25–33.
- Müller M, Mikoviny T, Jud W, D'Anna B, Wisthaler A. 2013. A new software tool for the analysis of high resolution PTR-TOF mass spectra. *Chemometrics and Intelligent Laboratory Systems* 127: 158–165.
- Na S, Ma L, Wang W, Sun H, Wang L, Baldwin IT, Wu J. 2019. Capsidiol, a defensive sesquiterpene produced by wild tobacco in response to attack from the fungal pathogen *Alternaria alternata*, is regulated by an ERF2-like transcription factor. *bioRxiv* 573675.
- Nieto-Jacobo MF, Steyaert JM, Salazar-Badillo FB, Nguyen DV, Rostás M, Braithwaite M, De Souza JT, Jimenez-Bremont JF, Ohkura M, Stewart A. 2017. Environmental growth conditions of *Trichoderma* spp. affects indole acetic acid derivatives, volatile organic compounds, and plant growth promotion. *Frontiers. Plant Science* 8: 102.
- Penuelas J, Asensio D, Tholl D, Wenke K, Rosenkranz M, Piechulla B, Schnitzler JP. 2014. Biogenic volatile emissions from the soil. *Plant Cell & Environment* 37: 1866–1891.
- Piechulla B, Lemfack MC, Kai M. 2017. Effects of discrete bioactive microbial volatiles on plants and fungi. *Plant, Cell & Environment* 40: 2042–2067.
- Pierce A, Pierce H, Oehlschlager A, Borden J. 1991. 1-octen-3-ol, attractive semiochemical for foreign grain beetle, *Ahasverus advena* (Walt) (Coleoptera: Cucujidae). *Journal of Chemical Ecology* 17: 567–580.
- R Core Team. 2018. *R: A language and environment for statistical computing*. Vienna, Austria: R Core Team.
- Rasmann S, Köllner TG, Degenhardt J, Hiltbold I, Toepfer S, Kuhlmann U, Gershenson J, Turlings TC. 2005. Recruitment of entomopathogenic nematodes by insect-damaged maize roots. *Nature* 434: 732.
- Romano A, Capozzi V, Spano G, Biasioli F. 2015. Proton transfer reaction–mass spectrometry: online and rapid determination of volatile organic compounds of microbial origin. *Applied Microbiology and Biotechnology* 99: 3787–3795.
- Romoli R, Papaleo M, De Pascale D, Tutino M, Michaud L, LoGiudice A, Fani R, Bartolucci G. 2014. GC–MS volatolomic approach to study the antimicrobial activity of the antarctic bacterium *Pseudoalteromonas* sp. TB41. *Metabolomics* 10: 42–51.
- Sardá-Espinosa A. 2017. *Comparing time-series clustering algorithms in R using the dtwclust package*. Vienna, Austria: R Development Core Team.
- Sardá-Espinosa A, Sardá MA, LazyData T. 2019. *Package 'dtwclust'*. [WWW document] URL <https://github.com/asardaes/dtwclust>
- Schalchli H, Hormazabal E, Becerra J, Briceño G, Hernández V, Rubilar O, Diez MC. 2015. Volatiles from white-rot fungi for controlling plant pathogenic fungi. *Chemistry and Ecology* 31: 754–763.
- Schalchli H, Tortella G, Rubilar O, Parra L, Hormazabal E, Quiroz A. 2016. Fungal volatiles: an environmentally friendly tool to control pathogenic microorganisms in plants. *Critical Reviews in Biotechnology* 36: 144–152.
- Schmidt R, Cordovez V, De Boer W, Raaijmakers J, Garbeva P. 2015. Volatile affairs in microbial interactions. *ISME Journal* 9: 2329.
- Shrivastava A, Gupta VB. 2011. Methods for the determination of limit of detection and limit of quantitation of the analytical methods. *Chronicles of Young Scientists* 2: 21–25.
- Shoresh M, Harman GE, Mastouri F. 2010. Induced systemic resistance and plant responses to fungal biocontrol agents. *Annual Review of Phytopathology* 48: 21–43.
- Siddiquee S, Cheong BE, Taslima K, Kausar H, Hasan MM. 2012. Separation and identification of volatile compounds from liquid cultures of *Trichoderma harzianum* by GC-MS using three different capillary columns. *Journal of Chromatographic Science* 50: 358–367.
- Stotzky G, Schenck S, Papavizas GC. 1976. Volatile organic compounds and microorganisms. *CRC Critical Reviews in Microbiology* 4: 333–382.
- Tang Y, Horikoshi M, Li W. 2016. ggfortify: unified interface to visualize statistical results of popular R packages. *The R Journal* 8: 474–489.
- Thet K, Woo N. 2019. *Gas chromatography*. [WWW document] URL [https://chem.libretexts.org/Bookshelves/Analytical\\_Chemistry/Supplemental\\_Modules\\_\(Analytical\\_Chemistry\)/Instrumental\\_Analysis/Chromatography/Gas\\_Chromatography](https://chem.libretexts.org/Bookshelves/Analytical_Chemistry/Supplemental_Modules_(Analytical_Chemistry)/Instrumental_Analysis/Chromatography/Gas_Chromatography). [accessed 1 September 2019].
- Toffano L, Fialho MB, Pascholati SF. 2017. Potential of fumigation of orange fruits with volatile organic compounds produced by *Saccharomyces cerevisiae* to control citrus black spot disease at postharvest. *Biological Control* 108: 77–82.
- Uehling J, Gryganskiy A, Hameed K, Tschaplinski T, Misztal PK, Wu S, Desirò A, Vande Pol N, Du Z, Zienkiewicz A et al. 2017. Comparative genomics of *Mortierella elongata* and its bacterial endosymbiont *Mycovoidus cysteinexigens*. *Environmental Microbiology* 19: 2964–2983.
- Veres P, Behrendt T, Klaphor A, Meixner F, Williams J. 2014. Volatile Organic Compound emissions from soil: using Proton-Transfer-Reaction Time-of-Flight Mass Spectrometry (PTR-TOF-MS) for the real time observation of microbial processes. *Biogeosciences Discussions* 11: 12009–12038.
- Weikl F, Ghirardo A, Schnitzler J-P, Pritsch K. 2016. Sesquiterpene emissions from *Alternaria alternata* and *Fusarium oxysporum*: effects of age, nutrient availability, and co-cultivation. *Scientific Reports* 6: 22152.
- Werner S, Polle A, Brinkmann N. 2016. Belowground communication: impacts of volatile organic compounds (VOCs) from soil fungi on other soil-inhabiting organisms. *Applied Microbiology and Biotechnology* 100: 8651–8665.
- Wihlborg R, Pippitt D, Marsili R. 2008. Headspace sorptive extraction and GC-TOFMS for the identification of volatile fungal metabolites. *Journal of Microbiological Methods* 75: 244–250.
- Xu C, Jackson SA. 2019. Machine learning and complex biological data. *Genome Biology* 20: 76.
- Zhang Z, Li G. 2010. A review of advances and new developments in the analysis of biological volatile organic compounds. *Microchemical Journal* 95: 127–139.

## Supporting Information

Additional Supporting Information may be found online in the Supporting Information section at the end of the article.

**Fig. S1** Growth curves of the *Trichoderma* species.

**Fig. S2** Pictures of *Trichoderma* cultures at the onset and the end of the PTR-ToF-MS-measurements.

**Fig. S3** Workflow.

**Fig. S4** Total emission intensity of sesquiterpenes detected by PTR-ToF-MS.

**Fig. S5** Comparison of the volatile compounds emitted by the four *Trichoderma* species.



**Table S1** The compounds (mass to charge ratios  $m/z$ ) detected by proton transfer reaction time-of-flight mass spectrometry (PTR-ToF-MS) and corresponding tentative annotations.

**Table S2** Limit of detection (LOD) of individual compounds related to potential emission rate that may be detected from fungi using the VOC platform (normalized to  $\text{cm}^{-2}$  mycelium area).

**Table S3** Chemical identification and chromatographic characteristics of detected VOCs by GC-MS analysis.

**Table S4** Mean emission intensities of all the compounds detected by PTR-ToF-MS ( $\text{ncps cm}^{-2} \text{s}^{-1}$ ) and GC-MS

( $\text{pmol cm}^{-2} \text{h}^{-1}$ ) from *T. harzianum* (tha), *T. hamatum* (thm), *T. reesei* (tre) and *T. velutinum* (tve).

Please note: Wiley Blackwell are not responsible for the content or functionality of any Supporting Information supplied by the authors. Any queries (other than missing material) should be directed to the *New Phytologist* Central Office.



## About *New Phytologist*

- *New Phytologist* is an electronic (online-only) journal owned by the New Phytologist Trust, a **not-for-profit organization** dedicated to the promotion of plant science, facilitating projects from symposia to free access for our Tansley reviews and Tansley insights.
- Regular papers, Letters, Research reviews, Rapid reports and both Modelling/Theory and Methods papers are encouraged. We are committed to rapid processing, from online submission through to publication 'as ready' via *Early View* – our average time to decision is <26 days. There are **no page or colour charges** and a PDF version will be provided for each article.
- The journal is available online at Wiley Online Library. Visit [www.newphytologist.com](http://www.newphytologist.com) to search the articles and register for table of contents email alerts.
- If you have any questions, do get in touch with Central Office ([np-centraloffice@lancaster.ac.uk](mailto:np-centraloffice@lancaster.ac.uk)) or, if it is more convenient, our USA Office ([np-usaoffice@lancaster.ac.uk](mailto:np-usaoffice@lancaster.ac.uk))
- For submission instructions, subscription and all the latest information visit [www.newphytologist.com](http://www.newphytologist.com)