

Climate change and building technologies: investigations of future weather scenarios on building energy performance

Daniel Kierdorf^{1,*}, Jakob Hahn² and Werner Lang¹

¹Technical University of Munich, Institute of Energy Efficient and Sustainable Design and Building, 80333 Munich, Germany

²Munich University of Applied Sciences, Department of Building Services Engineering, 80335 Munich, Germany

Abstract. This paper aims to investigate the impact of future climate on building systems, taking account of a strict building standard. A building is modelled in TRNSYS regarding a sustainable heating and cooling energy production by solar heating and radiative cooling in combination with water storage tanks. Sensitivity analyses (Morris Method) are performed for the technical building configurations for the years 2030, 2050 and 2100 (REMO climate model). They are compared and evaluated with the current reference climate (TRY) of 2017. The objective is to show which components have a significant influence on the energy consumption of buildings. Furthermore, due to the climate change sustainable building technologies are necessary. This paper demonstrates how the influence of the climate can be counteracted from the perspective of building services. Global warming requires a rethink of the interaction between building design, building technologies and climate. In this point building services engineering offers the most flexibility. By performing parameter studies, early knowledge about the building and its required technology can be gained. The target value of this study is the indoor air temperature as a function of the outdoor temperature. The objective function corresponds to specifications according to the European standard EN 15251. Following the parameter studies, optimization processes are carried out.

1 Introduction

Increasing energy efficiency is one of the most important measures to reduce greenhouse gas emissions and energy consumption throughout the life cycle of a building. Improving building constructions and building services technology cause a better cooperation of all persons involved in the planning and construction process. Global warming is a slow process and currently has no influence on the planning process of buildings and the dimensioning of the building technology.

Current climate scenarios indicate that, summer and winter periods in Germany will get warmer and milder, respectively through climate change. However, climatic changes are currently not considered in the dimensioning and design of technical building systems. Although they are highly probable over the life cycle of a building.

This study uses a simplified building model to demonstrate the effects of climate change on building services systems within a sustainable energy supply concept. Therefore, the main objective is to identify the key factors for a climate-neutral building operation regarding to plant and building technologies.

2 Methodology

To illustrate the future climate, three climate scenarios are examined in more detail. The climate data for the

years 2030, 2050 and 2100 are compared with the data for current planning processes from 2017 as a reference. The source for these climate data is the dynamic climate model REMO (regional dynamical climate downscaling model for Germany) by the DWD (Deutscher Wetterdienst). [1, 2]

On the one hand, the object of investigation consists of a single zone building model that corresponds to assumed requirements of a Nearly Zero Energy Building (nZEB) Standard 2021 according to the European Building Performance Directive (EPBD) [3, 4]. The object of research has a floor space of around 12 m². It has a glazing percentage of 60 %.

As the smallest unit of a building, a single room is selected as a one-zone model in order to keep the computation time as short as possible and to focus on the procedure for the investigation of the technology. In addition, the unit can be scaled to an entire building as well as to the level of city quarters afterwards.

On the other hand, it consists of a climate-neutral energy supply concept based on the solar heating and radiative cooling principle.

Solar Heating converts the existing solar radiation into heat as efficiently as possible. The heat is absorbed by a dark coated surface and transferred to the support medium water. In order to avoid heat losses within the absorber, it is surrounded by a vacuum tube made from low-iron glass.

* Corresponding author: daniel.kierdorf@tum.de

The principle of solar cooling is based on the long-wave radiation exchange of two surfaces. The warmer surface always transfers energy (heat) to the colder surface. In the context of the project a solar absorber is used to cool the building, using the night sky as an exchange surface. The clear night sky - without clouds - always has a lower temperature than the building and its ambient temperature on the earth's surface. Thus, an object on the earth's surface always emits long-wave heat radiation to the night sky.

Table 1 shows the assumed boundary conditions of the object of investigation in terms of building physics. The building is assigned an office-like use.

Table 1. Assumed characteristic values for the lowest energy standard 2021

parameter	unit	value
opaque components (envelope)	W/m ² K	U = 0.15
transparent components (envelope)	W/m ² K	U = 0.7
	W/m ² K	U _g = 0.5
	W/m ² K	U _f = 0.7
	W/mK	ψ = 0.045
total energy transmittance (glazing)	-	g = 0.5
linear thermal transmission factor (correction)	W/m ² K	UWB = 0.01
air change rate (infiltration and HVAC)	1/h	0.6

Fig. 1 illustrates a schematic representation of the system technologies consisting of two thermal storage tanks, one for floor heating and another for ceiling cooling, as well as the absorber surface (cooling) and the solar thermal collector surface (heating). The system is thus divided into four control loops, each equipped with a separate pump. The pumps are controlled by two-point controllers. The energy demand of the installed pumps is not considered further in this investigation.

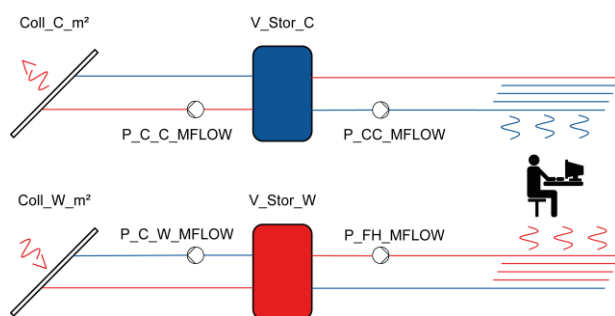

Fig. 1. System diagram of the investigated object

The hydraulic collector loop is controlled as a function of the total solar radiation (diffuse and direct radiation). If the irradiation on the south-facing vacuum tube collector (inclination 45°) rises above 100 W/m², the pump (P_C_W_MFLOW) for the circuit receives a signal and is switched on. However, this control is only

carried out until the temperature at the outlet of the collector exceeds the average temperature of the storage tank. The reason for this is to prevent the warm storage tank from losing energy via the collectors and being actively cooled.

On the other hand, the pump for the mass flux of the absorber loop (P_C_C_MFLOW), is not put into operation until the irradiation on the absorber surface (Coll_C_m2) drops to 0 W/m² and the ambient temperature is below the average temperature of the cold thermal storage tank. This avoids the pump from heating up the cold storage tank in warmer summer nights and allows heat to be radiated to the environment or night sky (principle of radiative cooling).

In order to provide a comfortable indoor environment for the occupants in the building, three different operating states are distinguished:

- (1) the building is heated by underfloor heating,
- (2) heat is extracted from the building by ceiling cooling,
- (3) neither heating nor cooling of the building is necessary.

Under these conditions, the control of the building systems is carried out on the basis of the outside temperature. If the running mean outdoor temperature of the last 24 hours is below 15 °C, the heating systems of the building is switched on. But if, on the other hand, the mean outdoor temperature rises above 15 °C, the cooling system of the building is enabled.

In addition, the heating function is only active when the room temperature drops below 20 °C and the temperature at the outlet of the thermal storage tank exceeds 25 °C. Cooling is also subject to the regulation that the temperature at the outlet of the thermal storage tank is below the room temperature.

In order to prevent the room from being (over-) heated by sunlight, an external sun protection system is installed, which is activated on the external surface of the window from an irradiation of 200 W/m². As soon as this limit is exceeded, the solar shading is closed by 75 %.

In order to fulfil the occupants' comfort requirements of the indoor space, flow temperatures for the underfloor heating are limited to a maximum of 35 °C. If the flow temperatures of the underfloor heating are above 35 °C, the heating flow is cooled down by the heating return flow using bypass control. [5]

In order to operate the system efficiently, large temperature differences between the supply and return flow of the underfloor heating are avoided.

The building and the building technologies are modelled in the software for dynamic building and equipment simulation TNSYS 17. In order to be able to demonstrate the influence of the climate on the individual components, the components are provided with parameters for multiple parametric runs. Table 2 shows all considered parameters.

In this study, the comfort band of DIN EN 15251 is selected as the objective function. This considers the inside air temperature above the outside temperature. The aim of the parametric studies is to achieve a maximum number of hours within the comfort band. [6]

Table 2. Overview of the considered parameters

parameter	acronym	unit	initial value
surface absorber	Coll_C_m ²	m ²	5
surface collector	Coll_W_m ²	m ²	5
storage capacity cold	V_Stor_C	m ³	
storage capacity warm	V_Stor_W	m ³	1
mass flux absorber loop	P_C_C_MFLOW	kg/h	300
mass flux collector loop	P_C_W_MFLOW	kg/h	500
mass flux cooling loop	P_CC_MFLOW	kg/h	100
mass flux heating loop	P_FH_MFLOW	kg/h	100

Fig. 2 shows the limit of the comfort band according to DIN EN 15251. In the winter period, an interior temperature between 20 °C and 24 °C is required, whereas in the summer period, a higher interior temperature between 24 °C and 28 °C is targeted.

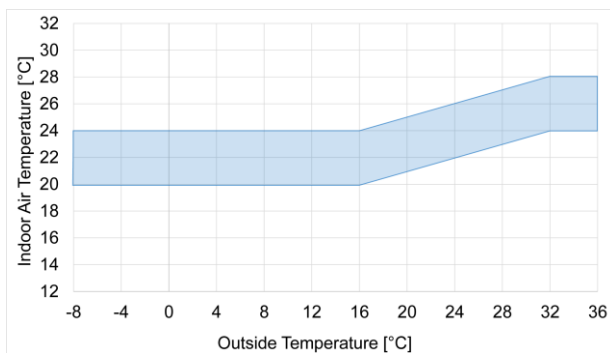

Fig. 2. Illustration of the comfort band according to DIN EN 15251

3 Case study

In order to identify the most influential parameters in advance, an one-step-at-a-time (OAT) method according to Morris is carried out [7]. This means that only one input parameter per building and plant simulation is varied in order to show its influence on the results (output) of the simulation. As an initial case study and current situation, this analysis is carried out on the basis of the 2017 test reference year (TRY). It was calculated over the period from 1995 to 2012 for Munich-Riem and is relevant for building and system simulations in present design phases.

Fig. 3 illustrates the results of this initial case study: Each point describes the indoor air temperature and the corresponding outside temperature for one hour within

the year. The improvement of the following optimization process can be evaluated on this basis scenario.

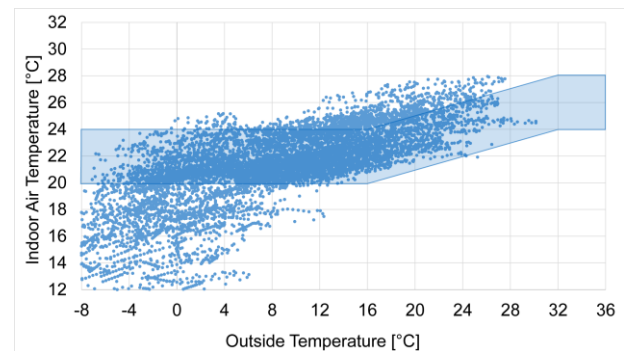

Fig. 3. Current status case study simulation (TRY 2017)

By varying the significance of the individual parameters, the relevance of the individual components becomes clear. Fig. 4 shows by way of example the influence of the variation of the parameter for the surface of the collector (Coll_W_m²) on the number of hours within the limits of the comfort band. It clearly shows that with increasing collector area, the number of hours within the comfort band can be increased.

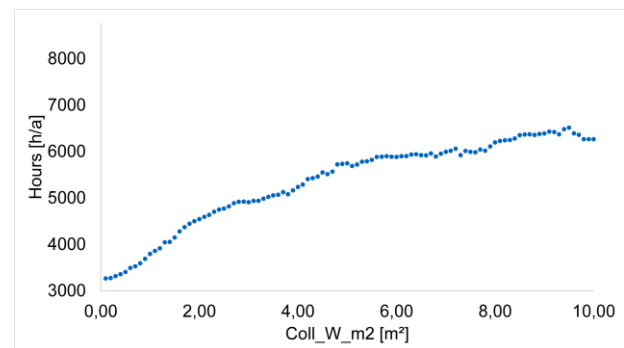

Fig. 4. Influence of the variation of the surface of the collector parameter (Coll_W_m²) on the number of hours within the comfort limits according to DIN EN 15251

The standard deviation of each individual parameter is determined from the measured data. Fig. 5 shows the standard deviation from the parameter of the collector's surface.

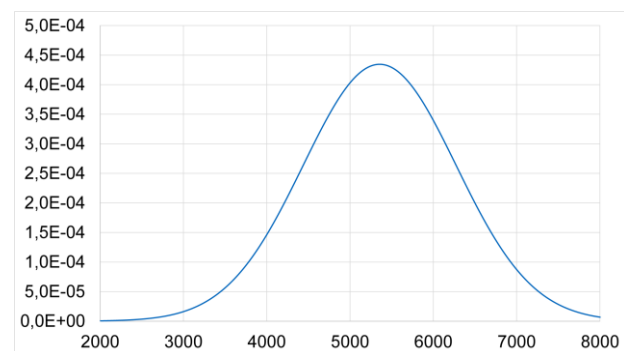

Fig. 5. Standard deviation of the surface of the collector parameter (Coll_W_m²)

This procedure is performed for all parameters. By comparing the standard deviation and the empirical

mean value, the influence of each individual parameter on the simulation results can be determined (Morris method). Fig. 6 illustrates the results of the Morris method of all considered technical parameters.

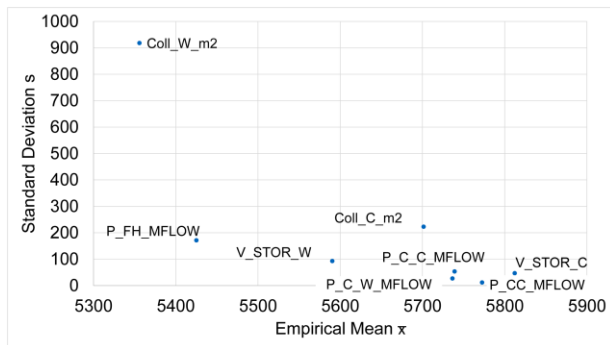

Fig. 6. Morris method of the case study

It is obvious that the parameter for the surface of the collector (Coll_W_m2) has both, a high standard deviation as well as a low mean value. This means that with small variations of the input parameter a high influence on the output of the simulation could be observed. In further research considerations, this procedure will be carried out on the basis of climate scenarios 2030, 2050 and 2100.

4 Results and discussion

4.1 Screening (Morris Method)

The climate data for the simulations and analysis are taken from the regional dynamic climate model REMO. Complex physical interrelationships of climate change are taken into consideration by the dynamic climate model. Compared to other climate models, this model predicts strong global warming by 2100, which can be seen in Fig. 7. The figure illustrates a comparison of the outside temperatures for a period of four weeks in January for the years 2017 and 2100.

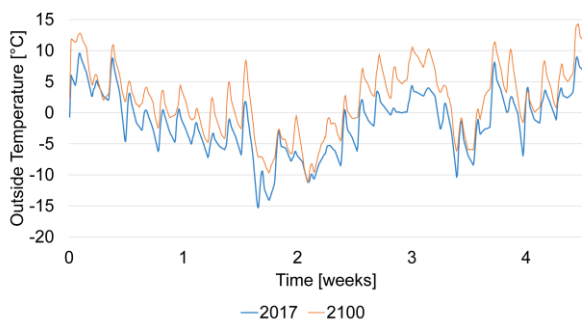

Fig. 7. Comparison of January outside temperatures in 2017 and 2100

The results of this investigation confirms that the climate scenario 2100 always produces the worst results (hours within the comfort band) for all parameters. In the following, the surface parameters for the collector

(Coll_W_m2) and the absorber (Coll_C_m2) will be discussed as examples, since the largest deviations could be observed here. The following figures show the variation of the parameter on the x axis and the results of the simulation on the y axis. The simulation results reflect the number of hours within the limits of the comfort band according to DIN EN 15251. Fig. 8 and Fig. 9 show that the performance of the system can be significantly improved as the collector area increases.

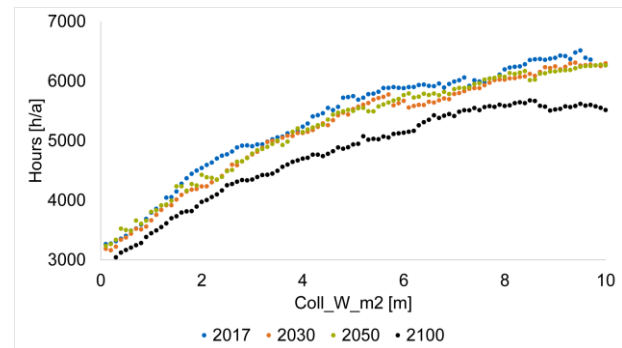

Fig. 8. Results for the surface of the collector area parameter (Coll_W_m2)

The curve for the absorber surface in Fig. 9 is flatter than the curve for the warm collector surface (Fig. 8). However, the Climate Scenario 2100 delivers the worst results (hours within the comfort band) here as well.

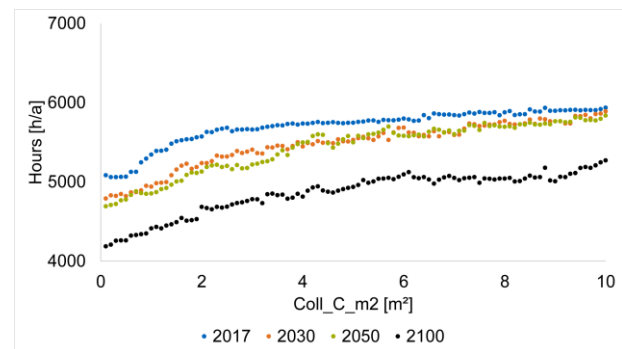

Fig. 9. Results of the parameter for the surface of the absorber area parameter (Coll_C_m2)

As the collector area increases, the gradient of the curves decreases. The results (hours within the comfort band) in the infinite are approaching a certain limit value. The maximum number that is possible is 8760 hours within the comfort band. However, this was not considered further, since a collector surface of more than 10 m² for this object of investigation is unrealistic in practical application.

In addition, it can also be seen, that small collector area parameters (Coll_W_m2) lead to worse results. On the other hand, small collector areas already deliver good results.

Fig. 10 and Fig. 11 show the Morris results for the area parameters of the collector (Coll_W_m2) and absorber (Coll_C_m2) depending on the different climate scenarios. The arithmetic mean value is displayed on the x axis. The y axis shows the standard deviation. As the results of scenario 2100 become flatter,

the standard deviation of parameter for the collector (Coll_W_m2) decreases. The initial situation in 2017 provides a high empirical average across the board. However, a variation of the input values has a significant influence on the results of the simulation, which can be seen by the high standard deviation. The climate scenarios 2030 and 2050 provide nearly comparable results.

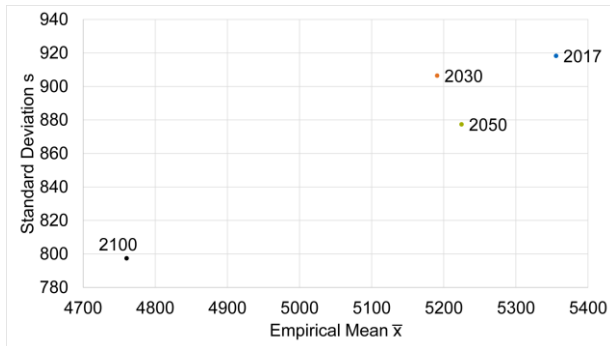

Fig. 10. Morris method of the parameter for the surface area of the collector (Coll_W_m2)

Due to the flatter curve of the parameter for the heating collector area (Coll_C_m2) in Fig.9, more consistent standard deviations result across all scenarios. Merely the empirical mean values show strong deviations. Thus, scenario 2017 has the highest mean value and scenario 2100 the lowest.

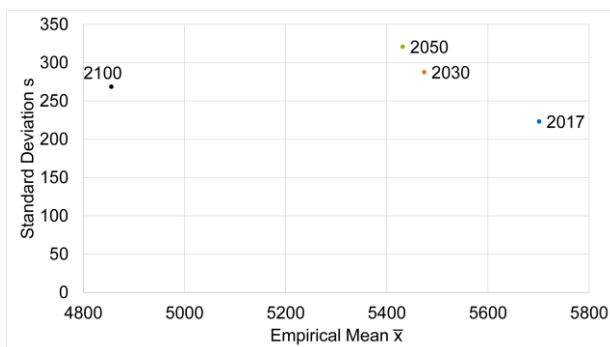

Fig. 11. Morris method of the parameter for the absorber area of the collector (Coll_C_m2)

From the point of view of the parameter of the collector (Coll_W_m2), a climatic change will lead to a constant operation with varying collector area. In the result, the empirical mean value for the collector area does not change significantly between the parameter variation. At the same time, the empirical mean decreases, which is represented by a lower number of hours within the comfort band.

The variation of the parameters for the cool water storage capacity (V_Stor_C), the warm water storage capacity (V_Stor_W), as well as the mass flux of the absorber loop (P_C_C_MFLOW), the collector loop (P_C_W_MFLOW), the cooling loop (P_CC_MFLOW) and the heating loop (P_FH_MFLOW) have in relation to the two considered parameters a minor influence on the output of the simulation and are not shown here. The trend of the results are similar for all considered

parameters. The climate scenario 2100 always delivers the worst results.

4.1 Optimization (Hooke-Jeeves)

In a second step, the two most influential parameters namely the surface area of the collector (Coll_W_m2) and of the absorber (Coll_C_m2) are optimized with the aid of optimization procedures. For this purpose GenOpt is used as an optimization tool [8]. The Hooke-Jeeves algorithm was selected as the optimization algorithm [9]. This represents a nonlinear optimization method that sets an random starting point in the functional area of the optimized function and approaches a minimum step by step. Thereby only one parameter of the N coordinate axes is changed at a time. The result of the previous simulation is compared and evaluated. If no improvement of the optimization is recognizable, the value is reset and executed with the same step size in the negative direction. It has already evaluated to be suitable for this kind of research [10-13].

Fig. 12 illustrates the results of the optimization of the climate scenario 2100 by varying the parameters Coll_W_m2 and Coll_C_m2.

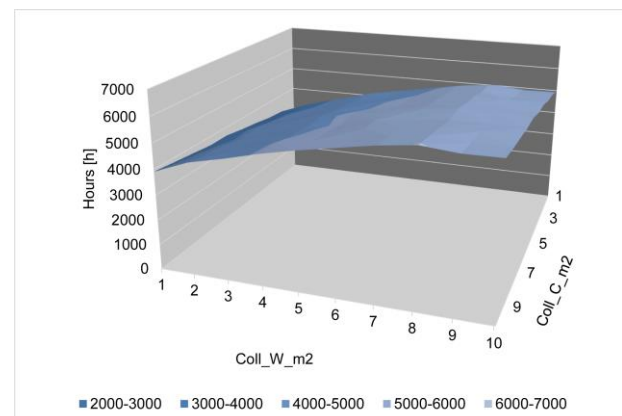

Fig. 12. Results of the optimization of scenario 2100

It is obvious that the variation of the collector area (Coll_W_m2) has a greater influence on the results than the variation of the absorber area (Coll_C_m2).

Table 3 lists the results for the parameters Coll_W_m2 and Coll_C_m2 after performing the optimization procedures. The values are within the selected interval (both intervals between 1 m² and 10 m²) and do not reach the interval boundaries. It can be assumed that the interval boundaries are well chosen.

Table 3. Results of the optimization

parameter	acronym	unit	result value
surface absorber	Coll_C_m ²	m ²	6.31
surface collector	Coll_W_m ²	m ²	9.58

Figure 13 shows the resulting air temperatures in the room using the comfort band after the optimization. Compared to Fig. 3, a significant improvement or shift of the hours within the comfort band can be observed.

However, it is also clear that the subject of building heating - due to the large number of hours below the comfort band - will always have a major influence on the planning process. The deviations above the comfort band are not particularly negative. A maximum of 26 °C indoor air temperature is acceptable at corresponding outside temperatures. In order to increase the cold interior temperatures, an (electric) auxiliary heater can be installed in the warm thermal storage tank. However, it is important to ensure that the required auxiliary energy is obtained from renewable sources.

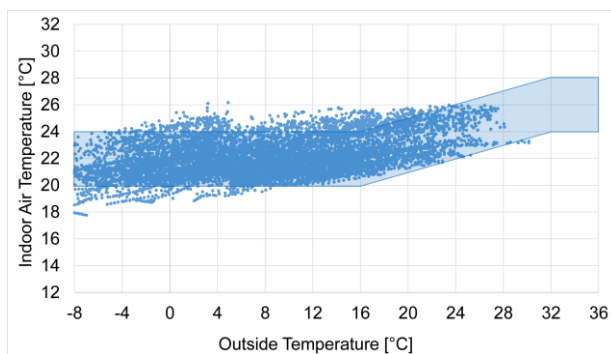

Fig. 13. Results of indoor air temperatures shown on the comfort band after the optimization

5 Conclusion

The optimized system technology demonstrates that with solar heating and radiative cooling it is possible to heat or cool a building in a climate-neutral way. Deviations from the comfort band are negligible and hardly drop below an internal temperature of 18 °C.

With regard to the aspect of sustainable building technology, this study shows the influence of different technical building components (primarily the collector area for heating and absorber area for cooling) on indoor comfort by changing the climatic boundary conditions.

The results expose that the current planning and design and dimensioning requirements are inadequate due to climatic changes. This can be seen in low empirical mean values for future climates. Nevertheless, the standard deviation for future climates is decreasing. Considering the parameter Coll_C_m2 (absorber area), the standard deviation remains almost identical, whereas having regard to the collector surface (Coll_W_m2), the standard deviation will decrease in the future. This means that a deviation from the current situation has a smaller influence on the simulation output by varying the collector or absorber area than with a high standard deviation.

The optimization results show that the variation of the collector area has a considerable influence on the simulation output and thus on the number of hours within the comfort band.

For the above reasons structural and technical standards have to adapt to the climatic boundary

conditions over time. However, since building physics standards are reaching limits, the focus will move more and more towards the field of building technologies. Due to warmer future climatic conditions (global warming), the focus will shift to cooling of buildings, but heating in moderate warm climates like Munich will still dominate.

Since building standards are modified relatively quickly compared to changing climatic conditions, the planning process will adapt to climate change over time.

In addition, the size of solar thermal systems is a decisive factor in determining whether a building can be sustainably supplied with heat and cold. In this research study, the mass flows of the installed pumps could not be identified as decisive parameters for the realisation of nearly zero-energy buildings.

6 Outlook and further research

In further research analysis variations are to take place with regard to building usage as well as variations in ventilation systems. The influence of ventilation and air conditioning systems can already be assumed to be the largest uncertainty in technical building systems. The variation of the air exchange rate leads to heating or cooling of the object under investigation and thus makes the rest of the system technology obsolete. Since an air conditioning system is absolutely necessary in increasingly tight building envelopes, in a further step the interactions between the technical building systems must be examined in more detail.

References

1. Deutscher Wetterdienst. Max-Planck-Institut für Meteorologie. Deutschland Available from: <http://www.dwd.de/>.
2. D. Jacob, E. Nilson, L. Tomassini, K. Bülow. REMO A1B SCENARIO RUN, BFG PROJECT, 0.088 DEGREE RESOLUTION, 1H values. World Data Center for Climate (WDCC) at DKRZ. http://cera-www.dkrz.de/WDCC/ui/Compact.jsp?acronym=REMO_BFG_A1B_1H, (2009)
3. M. Keltch, W. Lang und T. Auer, Buildings, Jg. 7, nr. 1, p. 25, (2017)
4. European Union: Directive 2010/31/EU of the European Parliament and of the Council of 19 May 2010 on the energy performance of buildings (EPBD), (2010)
5. Deutsches Institut für Normung, Raumflächenintegrierte Heiz- und Kühlsysteme mit Wasserdurchströmung, Berlin, 2011.
6. Deutsches Institut für Normung, Eingangsparameter für das Raumklima zur Auslegung und Bewertung der Energieeffizienz von Gebäuden - Raumluftqualität, Temperatur, Licht und Akustik, Berlin, 2012.
7. M. D. Morris, Technometrics, Jg. 33, Nr. 2, S. 161, 1991.

8. M. Wetter, GenOpt - Generic Optimization Program, Available at <https://simulationresearch.lbl.gov/GO/>, California, (2016)
9. R. Hooke, T. A. Jeeves, Direct Search Solution of Numerical and Statistical Problems”, *Journal of the ACM*, Jg. 8, Nr. 2, S. 212–229, (1961)
10. M. Wetter, J. Wright, Comparison of a Generalized Pattern Search and a Genetic Algorithm Optimization Method, Eighth International IBPSA Conference, Eindhoven, Netherlands, (2003)
11. M. Wetter, J. Wright, A comparison of deterministic and probabilistic optimization algorithms for nonsmooth simulation-based optimization”, *Building and Environment*, Jg. 39, Nr. 8, S. 989–999, (2004)
12. M. Wetter, E. Polak, A convergent optimization method using pattern search algorithms with adaptive precision simulation, *Building Services Engineering Research and Technology*, Jg. 25, Nr. 4, S. 327–338, (2004)
13. M. Wetter, E. Polak, Building design optimization using a convergent pattern search algorithm with adaptive precision simulations, *Energy and Buildings*, Jg. 37, Nr. 6, S. 603–612, (2005)