

Alma Mater Studiorum – Università di Bologna
in cotutela con Technical University of Munich

DOTTORATO DI RICERCA IN
ARCHITETTURA E CULTURE DEL PROGETTO

Ciclo XXXIII

Settore Concorsuale: 08/C1 – DESIGN E PROGETTAZIONE TECNOLOGICA
DELL'ARCHITETTURA

Settore Scientifico Disciplinare: ICAR/10 – ARCHITETTURA TECNICA

ON THE USE OF THE EXOSKELETON FOR SEISMIC IMPROVEMENT AND
INTEGRATED EFFICIENT TECHNOLOGIES IN EXISTING BUILDINGS

Presentata da: Lorenzo Badini

Coordinatore Dottorato

Annalisa Trentin

Supervisor

Annarita Ferrante

Stefan Winter

Co-supervisor

Giorgia Predari

Stephan Ott

Esame finale anno 2022

TUM School of Engineering and Design

On the Use of Exoskeleton for Seismic Improvement and Integrated Efficient Technologies in Existing Buildings

Lorenzo Badini

Vollständiger Abdruck der von der TUM School of Engineering and Design der Technischen Universität München zur Erlangung des akademischen Grades eines Doktors der Ingenieurwissenschaften (Dr.-Ing.) genehmigten Dissertation.

Vorsitzender:

Prof. Dr.-Ing. Giuseppe Margani

Prüfende der Dissertation:

1. Prof. Dr.-Ing. Stefan Winter
2. Prof. Dr.-Ing. Jan-Willem G. van de Kuilen
3. Prof. Dr.-Arch. Annarita Ferrante
4. Prof. Dr.-Ing. İhsan Engin Bal

Die Dissertation wurde am 11.01.2022 bei der Technischen Universität München eingereicht und durch die TUM School of Engineering and Design am 18.03.2022 angenommen.

Abstract

The renovation of the existing building stock is an increasingly important issue. Buildings designed and constructed between the 1960s and 1990s (approximately 70% of the total stock), characterised by outdated structural and energy requirements, are currently reaching the end of their design life. As part of the ProGET-onE framework, the following research focuses on the assessment, design, and verification of external strengthening structures, in order to achieve seismic improvement of existing RC residential buildings. This focus includes the necessary integration of architectural components, which are directly connected to the strengthening structures and designed to ensure indoor comfort through energy retrofitting of the residential building envelope.

The strategy of the EU project consists in a holistic solution that combines seismic and energy improvements and, through prefabricated volumetric extensions, an architectural renovation of existing buildings. In order to achieve all these objectives in a single intervention and to minimise disruption to the inhabitants during the construction process, the strengthening structures were designed to be placed outside the perimeter of the existing building, with a three-dimensional configuration, the exoskeleton.

After an overview of the current state of science and technology, different configurations of the external steel structures were designed and implemented on existing buildings to evaluate the seismic improvement. Linear and non-linear seismic analyses were performed to assess the vulnerability of the structural systems before and after the application of the exoskeleton on three case studies (Athens, Bagnolo in Piano, and Brasov).

An in-depth analysis was carried out for a student house in Athens, not only evaluating the structural strengthening, but also developing a draft of the definitive design for the prototype implementation. Proposals were made for structural foundations, steel connections, preassembled components, and erection methods. The seismic retrofit strategy was proved to be effective in meeting the damage limitation limit state (LS DL) requirements for all analyses performed (modal response spectrum, pushover, and time-history analyses), increasing global strength and stiffness, and reducing the displacements affecting the existing structure. The target displacement checks performed with the pushover analysis, after the application of the strengthening structure, showed induced vulnerability to the limit state of near collapse (LS NC) due to the reduction in displacements affecting the inelastic performance of the structure. Therefore, to further investigate this behaviour, non-linear dynamic analyses based on artificial accelerograms matched with elastic response spectra, were defined and performed, showing an improvement in terms of the formation of plastic hinges at the LS NC.

Then, with reference to the Italian feasibility study, a comparison was made between the materials used for the external structure, including steel and structural aluminium. The results of the seismic analyses obtained with the two types of external structures were aligned and showed a significant improvement in relation to the seismic demand (quantifiable around 40% of capacity for the worst-case scenario).

Preliminary results of the European project have shown that the life cycle assessment for both metal solutions have a strong impact (of the total of about 700 tonnes of CO_{2e} generated in the whole renovation, 35% is due to the external steel structure), indicating the need for further development in order to address climate change mitigation and minimise the environmental impact. Therefore, the second part of the research explores the possibilities offered by engineered wood-based products, such as Cross-Laminated Timber (CLT). With reference to the Romanian feasibility study, an innovative structural system made of CLT panels was developed to investigate the possibility of offering the same multiple benefits as the steel exoskeleton. CLT walls were provided perpendicular to the external façades as strengthening elements, and interposed CLT slabs were foreseen at each floor level to introduce new architectural units together with the new envelope. While the connections to the foundations and to the existing RC frames are designed respectively with steel brackets and axial-connectors distributed along the height of the building, a Post-Tensioned connection between CLT panels (PT-CLT connection) is implemented in the system to guarantee resistance to horizontal actions and to ensure structural independence, higher level of prefabrication and architectural freedom of the façades. As in the previous cases, different parameters were compared to evaluate the seismic retrofitting strategy (stiffness, behaviour factor, target displacement verifications, etc.),

meeting previously unachieved design requirements thanks to a renewed deformed shape. The strengthening structure increased global stiffness and strength and reduced concentration of damage in the lower floors, typical of moment-resisting frame structures. This allowed a greater displacement capacity and a greater dissipation of energy.

Based on the current state of research on timber structures, the possibilities offered by PT connections were analysed and adapted to the designed solution. This PT-CLT connection was experimentally investigated under multiple cycles of vertical loads in the TUM laboratories to validate the adaptation of the analytical model assumed in the calculation and consequently to prove the efficiency of the external timber structure. The test results showed that the proposed analytical model is conservative (softer) for PT-CLT connections when low values of initial tendon force are assumed. By using the mean elastic moduli in compression perpendicular to the grain (obtained from mechanical tests based on EN408:2012) it was possible to bring the experimental results to convergence for most cases, concluding that the analytical model is able to predict the behaviour of the connection and to allow the implementation of the moment-rotation curve in the numerical analysis.

Finally, two different approaches are introduced for the design of the prefabricated elements characterising the architectural technology (functional layers ensuring airtightness, thermal protection, etc.), their assembly procedures and connection with the supporting structures (made of steel or timber), as well as the integration with the technical systems, that guarantee a renewed and efficient building envelope. The prefabricated elements developed in this research not only fulfil all static requirements for seismic retrofitting, but also give planners the possibility to arrange space for additional residential units. Thus, forming the basis for the development of a holistic renovation strategy that enables existing buildings to meet the functional requirements of a modern envelope, which is particularly important in times of climate change.

Riassunto

La riqualificazione degli edifici esistenti è un argomento sempre più rilevante nel panorama edilizio attuale. Gli edifici progettati e costruiti tra gli anni '60 e '90 (circa il 70% del patrimonio edilizio europeo), caratterizzati da prestazioni strutturali ed energetiche obsolete, stanno raggiungendo il termine della vita nominale di progetto. All'interno del progetto europeo Pro-GET-onE, la ricerca in oggetto si concentra sulla valutazione, progettazione e verifica di strutture di rinforzo finalizzate all'ottenimento del miglioramento sismico di edifici esistenti in calcestruzzo armato (CA). Lo scopo della tesi non esclude l'integrazione con le componenti architettoniche, che sono direttamente connesse alla componente strutturale, e progettate per garantire il benessere termo-igrometrico attraverso l'efficientamento dell'involucro esistente.

La strategia prevista dal progetto europeo prevede l'applicazione di una soluzione olistica che combina miglioramento sismico ed energetico e, attraverso estensioni volumetriche prefabbricate, una riqualificazione architettonica degli edifici esistenti. Per raggiungere questi obiettivi mediante un unico intervento, e minimizzando il disturbo sugli abitanti durante la fase di cantiere, la struttura di rinforzo è stata progettata per essere posizionata all'esterno del perimetro dell'edificio esistente, mediante una configurazione tridimensionale: l'esoscheletro.

In seguito ad una panoramica dello stato dell'arte, diverse configurazioni strutturali in acciaio sono state progettate e applicate su edifici esistenti con l'obiettivo di valutarne il miglioramento sismico. Analisi lineari e non lineari sono state effettuate per valutare la vulnerabilità dei sistemi strutturali prima e dopo l'applicazione dell'esoscheletro su tre casi di studio (Atene, Bagnolo in Piano e Brasov).

Un'analisi approfondita è stata effettuata sullo studentato di Atene, non solo valutando il miglioramento strutturale, ma anche sviluppando una proposta di progetto definitivo per la costruzione del prototipo. Sono state quindi sviluppate ipotesi progettuali sulle connessioni in acciaio, fondazioni, procedure di assemblaggio e sulle componenti prefabbricabili. La strategia di miglioramento sismico si è dimostrata efficace nel soddisfare i requisiti posti dallo stato limite di danno per tutte le tipologie di analisi effettuate (analisi lineari dinamiche, non lineari statiche e dinamiche), aumentando rigidità e capacità del sistema strutturale, e riducendone gli spostamenti. Le verifiche in termini di domanda di spostamento effettuate con l'analisi statica non lineare (*pushover*), in seguito all'applicazione della struttura di rinforzo, hanno dimostrato una vulnerabilità allo stato limite di collasso a causa della riduzione degli spostamenti che caratterizzano le prestazioni anelastiche della struttura. Pertanto, per indagare ulteriormente questo comportamento, sono state definite ed eseguite, analisi dinamiche non lineari basate su accelerogrammi artificiali abbinati agli spettri di risposta elastici, impedendo la formazione di cerniere plastiche a controllo di spostamento per lo stato limite di collasso.

Con riferimento allo studio di fattibilità italiano, è stato successivamente proposto un confronto tra i materiali impiegati per le nuove strutture, considerando acciaio e alluminio strutturale. La risposta sismica ottenuta con le due soluzioni progettuali è risultata allineata, dimostrando la possibilità di raggiungere un miglioramento significativo in relazione all'azione sismica di progetto (quantificabile, per lo scenario peggiorativo, intorno al 40%).

Risultati preliminari del progetto europeo hanno tuttavia dimostrato, tramite valutazione del ciclo di vita, che entrambe le soluzioni metalliche presentano un forte impatto ambientale (su un totale di circa 700 tonnellate di CO_{2e} generate dalla ristrutturazione, il 35% è dovuto alla struttura esterna in acciaio); palesando la necessità di estendere la ricerca in un'ottica di cambiamento climatico e mitigazione di questo impatto. Pertanto, la seconda parte dell'elaborato esplora le possibilità offerte dai prodotti ingegnerizzati a base di legno, come il CLT o XLAM (legno lamellare incrociato). Con riferimento allo studio di fattibilità rumeno, è stato sviluppato un sistema strutturale innovativo, composto da pannelli di CLT e progettato per offrire gli stessi molteplici benefici offerti dall'esoscheletro in acciaio. Le pareti in legno lamellare incrociato sono state progettate come elementi di rinforzo perpendicolarmente alle facciate esistenti, sono previste poi lastre dello stesso tipo inserite ad ogni livello di piano esistente con l'obiettivo di introdurre le nuove unità

architettoniche, comprensive di involucro. Mentre le connessioni alle fondazioni e ai telai in CA esistenti sono progettate rispettivamente con angolari in acciaio e connettori assiali distribuiti lungo l'altezza dell'edificio, un collegamento post-teso tra i pannelli in CLT (connessione PT-CLT) è impiegato nello schema strutturale per garantire la resistenza alle azioni orizzontali, un più alto livello di prefabbricazione e la libertà architettonica delle facciate. Come per gli studi di fattibilità precedenti, sono stati confrontati diversi parametri per valutare la strategia di miglioramento sismico (rigidezza, fattore di comportamento, verifiche in termini di domanda di spostamento, ecc.), soddisfacendo i requisiti di progettazione precedentemente non raggiunti grazie ad una diversa deformata. La struttura di rinforzo ha aumentato la rigidezza e la capacità globale, riducendo la concentrazione dei danni riscontrati ai piani inferiori, tipica delle strutture a telaio momento-resistente, permettendo una maggiore capacità di spostamento e dissipazione di energia.

Sulla base dello stato attuale della ricerca sulle strutture in legno, le possibilità offerte dalle connessioni PT sono state analizzate e adattate alla soluzione progettata. Questa connessione è stata investigata sperimentalmente nei laboratori dell'università tecnica di Monaco, mediante l'applicazione di molteplici cicli di carico verticale, atti a verificare l'adattamento del modello analitico assunto nel calcolo e di conseguenza dimostrare l'efficienza della struttura esterna in legno. I risultati della campagna sperimentale hanno mostrato che il modello analitico proposto è conservativo per le connessioni PT-CLT quando si assumono bassi valori di forza di precompressione iniziale. Utilizzando i moduli elastici medi in compressione perpendicolare alla fibratura (ottenuti dalle prove meccaniche basate sulla EN408:2012), è stato possibile portare a convergenza i risultati sperimentali per la maggior parte dei casi studiati, concludendo che il modello analitico è in grado di prevedere il comportamento della connessione e di permettere l'implementazione della curva momento-rotazione nell'analisi numerica.

Infine, vengono presentati due diversi approcci per la progettazione degli elementi prefabbricati che caratterizzano la tecnologia architettonica (stratigrafie che assicurano la tenuta termica e dell'acqua, ecc.), le loro procedure di assemblaggio e la connessione con le strutture di supporto (in acciaio o in legno), nonché l'integrazione con i sistemi impiantistici che garantiscono un involucro edilizio rinnovato ed efficiente. Le componenti preassemblate sviluppate in questa ricerca, non solo soddisfano tutti i requisiti statici per l'adeguamento sismico, ma danno anche ai progettisti la possibilità di organizzare lo spazio per ulteriori unità residenziali; formando così la base per lo sviluppo di una strategia olistica di ristrutturazione che permette agli edifici esistenti di soddisfare i requisiti funzionali di un involucro moderno, aspetto particolarmente importante nel contesto di transizione ecologica del patrimonio edilizio.

Kurzfassung

Die Instandsetzung des Gebäudebestands ist ein zunehmend wichtiges Thema. Gerade Gebäude, die zwischen den 1960er und 1990er Jahren entworfen und gebaut wurden (ca. 70% des Gesamtbestandes) und sich auszeichnen durch überholte strukturelle und energetische Anforderungen, erreichen derzeit das Ende Ihrer Bemessungslebensdauer. Im Rahmen von Pro-GET-onE konzentriert sich die folgende Forschungsarbeit auf die Entwicklung eines Sanierungskonzepts für die Überprüfung, Bewertung und Bemessung solcher Bestandstragwerke, um die seismische Performance bestehender Wohngebäude aus Stahlbeton zu verbessern. Dieser Schwerpunkt schließt die notwendige Integration funktionaler Schichten der Gebäudehülle mit ein, die durch energetische Sanierung die Energieeffizienz der Wohneinheiten gewährleisten sollen und direkt mit den in diesem Projekt entwickelten Verstärkungsmaßnahmen verbunden sind.

Ziel des EU-Projekts ist die Entwicklung einer ganzheitlichen Lösung, die seismische und energetische Verbesserungen mit einer architektonischen Renovierung bestehender Gebäude durch vorgefertigte volumetrische Erweiterungen kombiniert. Um all diese Ziele in einem einzigen Eingriff zu erreichen und die Beeinträchtigung der Bewohner während des Bauprozesses so gering wie möglich zu halten, wurden die verstärkenden Strukturen so konzipiert, dass sie mithilfe eines dreidimensionalen Konstrukts außerhalb des bestehenden Gebäudes angebracht werden können. Dieses bildet das sog. Exoskelett.

Nach einer umfassenden Recherche über den aktuellen Stand von Wissenschaft und Technik wurden verschiedene Anordnungen externer, an den Bestand angeschlossener Verstärkungsstrukturen aus Stahl entworfen. An drei Fallstudien bestehender Gebäude in (i) Athen (GR), (ii) Bagnolo in Piano (IT) und (iii) Brasov (RO) wurden lineare und nicht-lineare seismische Analysen durchgeführt, um die Anfälligkeit des Systems vor und nach der Errichtung der externen Stahlstruktur zu bewerten.

Am Fall eines bestehenden Studentenwohnheims in (i) Athen wurde eine eingehende Analyse durchgeführt, die nicht nur die mögliche Verstärkung der Tragstruktur des Gebäudes bewertete, sondern auch zur Entwicklung eines finalen Prototyps führte. Es wurden konkrete Vorschläge gemacht zu den Verbindungen innerhalb der Stahlstruktur und an den Bestand, zu ihrem Fundaments, dem konkreten Bauablauf sowie zu den vorgesehenen vorgefertigten Komponenten. Das Konzept für die seismische Ertüchtigung erwies sich bei allen durchgeführten Analysen (modales Antwortspektrum, Pushover- und Zeitverlaufsanalysen) als wirksam. Die Grenzzustände zur Schadensbegrenzung (LS DL: limit state of damage limitation) wurden nicht überschritten, die Standfestigkeit des Gebäudes wurde erhöht und Verformungen, die auf die bestehende Stahlbeton-Struktur einwirken, wurden reduziert. Die für die Pushover-Analyse angenommenen Zielverschiebungen ergaben eine erhöhte Anfälligkeit für ein Quasiversagen (LS NC: limit state of near collapse), nachdem die verstärkende Struktur angebracht worden war; eine Folge der Verringerung der Verformungen, die das inelastische Verhalten des Tragwerks beeinflussen. Zur weiteren Untersuchung wurden daher nichtlineare, dynamische Analysen auf der Grundlage von künstlichen Beschleunigungszeitverläufen definiert, durchgeführt und mit elastischen Antwortspektren abgeglichen. Sie bestätigten die Einhaltung der LS DL-Anforderungen und zeigten eine Verbesserung in Bezug auf die Bildung von verschiebungskontrollierten, nichtlinearen Gelenken im LS NC.

Anschließend wurde unter Bezugnahme auf eine italienische Machbarkeitsstudie in (ii) Bagnolo in Piano ein Vergleich zwischen den für die äußere Struktur verwendeten Materialien – darunter Stahl und Aluminium – durchgeführt. Bei der Gegenüberstellung der Ergebnisse der seismischen Analysen mit den beiden genannten Materialien ergab sich eine signifikante Verbesserung der seismischen Kapazität, auf ca. 40% im Vergleich zum Worst-Case-Szenario.

Der starke Einfluss der aus Metall entwickelten Gebäudehüllen auf die Ökobilanz der Gebäude (35% der beim Bau entstehenden 700 Tonnen von CO₂ entfallen auf die externe Stahlstruktur) weist jedoch auf die zwingende Notwendigkeit hin, weiterführende Lösungen zu entwickeln, um die Umweltbelastung zu minimieren und damit auch dem Klimawandel Rechnung zu tragen.

Daher wurde im zweiten Teil des Forschungsvorhabens das Potenzial des – in Bezug auf die CO₂ Bilanz – nachhaltigeren Baustoffes Brettspertholz (BSP) geprüft. Unter Bezugnahme auf die rumänische Fallstudie in (iii) Brasov wurde ein innovatives integriertes System aus BSP-Elementen entwickelt, das die gleichen vielfältigen – oben genannten – Vorteile erzielt wie das zuvor entwickelte Stahl-Exoskelett, ohne dabei die Ökobilanz der Gebäude negativ zu beeinflussen. BSP-Wände werden dazu senkrecht zu den Außenfassaden als versteifende Elemente angebracht. Dazwischen werden in jedem Stockwerk BSP-Platten installiert, um mit der neuen Gebäudehülle zusätzlich nutzbare Räume zu schaffen. Während die Verbindungen zu den Fundamenten und zum Betonrahmen aus Stahlwinkeln bestehen bzw. Verbindungen sind, die lediglich die axialen Belastungen übertragen und über die gesamte Höhe des Gebäudes verteilt sind, wird eine vorgespannte Verbindung zwischen BSP-Paneelen in das System eingebaut, um die Widerstandsfähigkeit gegenüber horizontal wirkenden Kräften zu gewährleisten. Dabei wird die strukturelle Unabhängigkeit respektive eines höheren Vorfertigungsgrads sichergestellt und gleichzeitig zusätzliche Maßnahmen zur Fassadenverstärkung vermieden. Wie in den vorangegangenen Fällen wurden verschiedene Parameter verglichen, um die Strategie der seismischen Verstärkung zu evaluieren (Steifigkeit, q-Faktor, Überprüfung der Zielverschiebungen, usw.). Dabei wurde, dank der Aktivierung von Lastumlagerungspotentialen, eine bisher unerreichte Erdbebensicherheit erzielt. Die Verstärkungsstruktur steigerte die Gesamtsteifigkeit und -tragfähigkeit des Gebäudes und reduzierte die Schadenkonzentration auf die unteren Stockwerke, ein typisches Merkmal momentstabiler Rahmenkonstruktionen. Dies erlaubt eine erhöhte Verformungskapazität und eine höhere Energiedissipation.

Basierend auf dem aktuellen Stand der Forschung zu Holzkonstruktionen wurden die Möglichkeiten vorgespannter Verbindungen analysiert und die zuvor entworfene Lösung daran angepasst. Diese Verbindungen wurden in den Testlabors der TUM unter mehreren Zyklen vertikaler Belastung experimentell untersucht, um zum einen die Validierung des in der Berechnung angenommenen analytischen Modells zu überprüfen und zum anderen, um die Effizienz der externen Holzkonstruktion nachzuweisen. Die Versuchsergebnisse haben gezeigt, dass das analytische Modell für vorgespannte Verbindungen konservativ (weicher) ausfällt, wenn niedrige Werte der anfänglichen Spanngliedkraft angenommen werden. Durch die Verwendung der Mittelwerte der Elastizitätsmodule in Druckrichtung senkrecht zur Faser (aus mechanischen Versuchen basierend auf EN 408:2012) war es möglich, die experimentellen Ergebnisse in den meisten Fällen mit den Modellen in Konvergenz zu bringen. Dies lässt den Schluss zu, dass das analytische Modell in der Lage ist, das Verhalten der Verbindung vorherzusagen und die Implementierung der Momenten-Verformungskurve in der numerischen Analyse zu ermöglichen.

Abschließend werden zwei Lösungsansätze vorgefertigter Elemente aus Stahl und Holz in Bezug auf die architektonischen Funktionsschichten (Luftdichtheit, Wärmeschutz, etc.), ihre Montageverfahren, die Verbindung mit dem Tragwerk sowie die Integration in technische Systeme, die eine erneuerte und effiziente Gebäudehülle garantieren, charakterisiert. Die in vorliegender Arbeit entwickelten, vorgefertigten Elemente erfüllen somit nicht nur alle statischen Anforderungen an seismische Ertüchtigungen, sondern geben den Planern darüber hinaus die Möglichkeit, Raum für zusätzliche Wohneinheiten anzuordnen. Sie bilden damit die Basis für die, gerade in Zeiten des Klimawandels, wichtige Instandsetzung des Gebäudebestandes an die funktionellen Anforderungen einer modernen Gebäudehülle.

Acknowledgements

This research is part of the *Pro-GET-onE project*, which has received funding from the *European Union's Horizon 2020 Innovation action* under grant agreement No 723747.

With particular reference to the experimental campaign at the Technical University of Munich, it is worth mentioning the sponsoring association: *Verein zur Förderung des Lehrstuhls für Holzbau und Baukonstruktion der Technischen Universität München e.V.*, which provided financial support.

Special thanks are also given to the companies that supported me with donations of material and technical support: *ABA Holz van Kempen GmbH, Steico, BBV Systems GmbH, Pollmeier, Dynea* and *Hundegger*.

Four years have passed since I decided to embark on this experience, and many people have contributed to my personal and scientific progress, as well as in feeding my constancy.

It is with pleasure that I sincerely and deeply thank Prof. Annarita Ferrante, as supervisor and constant supporter, who introduced me to the Department of Architecture of the University of Bologna and above all introduced me to the Pro-GET-onE network. From the very first analyses carried out for my master thesis, Annarita supported and promoted me, together with Prof. Giovanni Mochi (whom I thank as well), through personal and professional growth. Together with her and the researcher Fotopoulou we shared joys and sorrows from the very beginning of the project, in facing pros and cons of coordination and confrontation with the partners of the European project.

During the first two-year period in Bologna, I had the privilege of being further supported in my work by experts in renovation practices such as Prof. Predari and Prof. Custodi, whom I thank for their precise support. In addition, I would also like to thank fellow researchers such as Dr. Anastasia Fotopoulou, Cosimo De Stefano, Davide Cantelli, and Vieri Giannakopoulos who accompanied and helped me in the development of the research through production of project reports, presentations, conferences, and meetings.

The international nature of the research project was particularly relevant, and it was very stimulating and rewarding to have the opportunity to participate in the international conferences and meetings of Pro-GET-onE. During these events, I had the opportunity to get to know many experts in our work field and to compare and learn from them through continuous discussions and reflections on every detail of the project, without undermining the invaluable international social aspect that led us to share wonderful days (and evenings) together as a project consortium. I would like to thank the members of the consortium for all their suggestions, inputs, comparisons, criticisms and for sharing their experience during the events we spent together.

It was thanks to this relationship between the members of the European project consortium that we were able to organise the double degree doctorate between the two universities, which gave me the opportunity to spend the last two years at the Chair of Timber Structures and Building Construction of the Technical University of Munich.

First and foremost, I would like to thank my supervisor Prof. Stefan Winter, who made this partnership possible and included me in the Munich research group, characterised by professionalism in the topics dealt with and by a vivid research group. I considered myself lucky to have had the opportunity to be supervised by him and pushed to new limits in my research. Particular thanks go to researcher Stephan Ott, who has repeatedly supported me in the development of the second part of the research, from the conception to the final testing phase, and who has personally committed himself, even in the most difficult phases of fundraising and material collection. Together with him, Dr.-Ing. Patrik Aondio also provided fundamental support in the development of the technical-analytical part of the wooden project. Particularly challenging was the organisation of the laboratory tests, for which I have to thank the entire team at Meier-

Jens-Halle for their constant support in defining the setup and ensuring the complete safety of the tests. The master student Lukas Reumschuessel revealed himself as fundamental for the construction of the wooden test specimens and the success of the entire test campaign. He supported me step by step with his professional experience as a carpenter and his positive attitude, even in situations that seemed hopeless.

Without mentioning the bureaucratic aspect linked to the organisation and coordination of the two university systems, the well-known pandemic certainly put a brake on the social and cultural aspect that could have characterised my German experience, but despite the premises I would like to reiterate how constructive and reinforcing this experience was for me, from a personal and professional point of view, putting me more under pressure, not only from a scientific point of view, thanks to the results obtained experimentally, but also socially. Despite these difficulties, I have found a close-knit group of people in Munich who have supported and accompanied me both inside and outside the university environment. I would therefore like to express my general thanks to the colleagues and friends who have characterised my experience in Bavaria, and who join the ranks of people who have been important to me from Italy, from home and from Bologna, who have continued to support me over the years, and who have shown me that distance is not enough to break certain bonds.

Thank you all very much.

Index

Abstract	I
Riassunto	III
Kurzfassung.....	V
Acknowledgements	VII
Index	IX
1. Introduction	1
2. The seismic issue in existing buildings	5
2.1 Introduction on earthquakes	5
2.2 Earthquakes in Europe	6
2.3 Vulnerabilities of existing reinforced concrete (RC) buildings	8
2.4 Seismic strengthening strategies for RC buildings	14
2.4.1 Local interventions	17
2.4.2 Global interventions	19
2.4.3 Use of isolation or dissipation devices	27
2.4.4 Additional evaluation criteria for strengthening solutions	30
3. Energetic, practical, and socio-economic aspects	35
3.1 Characterisation of the building stocks in seismic zones	35
3.1.1 Italy	35
3.1.2 Greece	36
3.1.3 Romania	38
3.1.4 The Netherlands	40
3.1.5 Spain	41
3.2 The energetic performance in existing RC buildings	42
3.3 Synergy in building renovation projects	45
3.3.1 State of the art of multiple benefit approaches	46
3.3.2 Pro-GET-onE and its possible impacts	54
4. State of the art on external strengthening techniques	57
4.1. Reinforced concrete walls	58
4.2. Steel frames	60
4.3. Wooden structures	68
4.4. Needs and advantages leading to alternative techniques	72
5. Seismic improvement through the exoskeleton	77
5.1 The Greek case study – towards the prototype	77
5.1.1 Initial state, before the intervention	81
5.1.1.1 Materials.....	81
5.1.1.2 Structural scheme and characterisation of the members.....	82
5.1.1.3 Modelling parameters	85

5.1.1.4 Results	90
5.1.2 Project state, application of the steel exoskeleton	98
5.1.2.1 Materials.....	98
5.1.2.2 Structural scheme and characterisation of the members.....	98
5.1.2.3 Modelling parameters	100
5.1.2.4 Results	103
5.1.2.5 Result comparison and final quantities.....	110
5.1.3 Project state, impact assessment of on-top extension	114
5.1.3.1 Structural scheme and characterisation of the members.....	114
5.1.3.2 Modelling parameters	116
5.1.3.3 Results	117
5.1.3.4 Result comparison and final quantities.....	124
5.1.4 Non-linear dynamic analyses results and considerations.....	128
5.1.4.1 Modelling parameters	128
5.1.4.2 Results	130
5.1.5 Preliminary design and first assumptions on connections and foundations ...	134
5.1.6 Implementations that led to the development of the prototype	142
5.2 The Italian case study – an experimentation of structural aluminium	145
5.2.1 Initial state, before the intervention	147
5.2.1.1 Materials.....	147
5.2.1.2 Structural scheme and characterisation of the members.....	149
5.2.1.3 Modelling parameters	153
5.2.1.4 Results	157
5.2.2 Project state, application of the steel exoskeleton	163
5.2.2.1 Materials.....	163
5.2.2.2 Structural schemes and characterisation of the members	163
5.2.2.3 Modelling parameters	165
5.2.2.4 Results	167
5.2.3 Project state, application of the aluminium exoskeleton	172
5.2.3.1 Materials.....	172
5.2.3.2 Structural schemes and sections.....	172
5.2.3.3 Modelling parameters	174
5.2.3.4 Results	175
5.2.3.5 Verifications of the exoskeleton.....	179
5.2.3.6 Result comparison and final quantities.....	183
5.2.4 Italian seismic classification – Sisma Bonus	186
5.2.4.1 Initial State – Sisma Bonus.....	186
5.2.4.2 Project state (steel) – Sisma Bonus	189
5.3 The Romanian case study – the timber exoskeleton	191

5.3.1	Initial state, the RC precast walls structure in Brasov	195
5.3.2	Initial state, a virtual RC moment-resisting frame structure in Brasov	198
5.3.2.1	Materials.....	198
5.3.2.2	Structural scheme and characterisation of the members.....	198
5.3.2.3	Modelling parameters	200
5.3.2.4	Results	204
5.3.3	Project state, application of the timber exoskeleton	208
5.3.3.1	Materials.....	208
5.3.3.2	Structural scheme and characterisation of the members.....	209
5.3.3.3	PT-CLT Connection and other connectors.....	211
5.3.3.4	Modelling parameters	218
5.3.3.5	Results	226
5.3.3.6	Result comparison	237
6.	Post-tensioned CLT connection	243
6.1	State of the art	243
6.1.1	From Pres-Lam® to present days.....	243
6.1.2	The ETH Zurich experience	246
6.1.2.1	Performance under gravity loads	246
6.1.2.2	Performance under horizontal loads.....	248
6.1.2.3	Long-term behaviour.....	248
6.1.2.4	Prototype design and final considerations.....	249
6.2	The analytical model and its adaptation to CLT elements.....	249
6.2.1	Existing analytical model	250
6.2.1.1	Simplified spring model.....	250
6.2.1.2	Equilibrium at the interface and determination of the rotational behaviour.....	251
6.2.1	Adaptation of the analytical model to CLT panels	253
6.3	Connection tests	254
6.3.1	Mechanical and physical properties of the timber specimens	255
6.3.1.1	Material and dimensions.....	256
6.3.1.2	Instrumentation and test setup.....	257
6.3.1.3	Test procedure and data evaluation	258
6.3.1.4	Results of the mechanical tests.....	260
6.3.2	PT-CLT connection, specimens, instrumentation, and setup	262
6.3.2.1	Materials and specimens.....	262
6.3.2.2	Setup.....	264
6.3.2.3	Instrumentation.....	266
6.3.2.4	Test boundaries and issues.....	268
6.3.3	Testing program and protocols	268
6.3.4	Analysis of the experiments	271

6.3.4.1	Application of the tendon force and initial compression.....	271
6.3.4.2	Rotation	272
6.3.4.3	Key variables.....	274
6.3.5	Evaluation of the experimental tests and comparison with the analytical model .	278
6.3.5.1	PTT2-1.....	278
6.3.5.2	PTT3-1.....	283
6.3.5.3	PTT4-2-1.....	287
6.3.5.4	PTT5-1-1.....	293
6.4	Final considerations	299
6.4.1	Comparisons	299
6.4.1.1	Between cycles	299
6.4.1.2	Between left and right horizontal elements.....	300
6.4.1.3	Between test typologies	301
6.4.1.4	Regarding the initial stiffness	303
6.4.2	Conclusions on PT-CLT tests	305
7.	Synergic integration of the technologies	307
7.1	The Athens definitive design – on the steel exoskeleton	307
7.1.1	Overview of the renovation project.....	307
7.1.2	Design challenges and inputs from the consortium	312
7.1.3	Technical details and applications	315
7.1.3.1	Extra-room and sun-space.....	315
7.1.3.2	Balcony	317
7.2	The Brasov design – on the timber exoskeleton	323
7.2.1	Overview of the renovation project.....	323
7.2.2	Design challenges	327
7.2.3	Assembly procedure of the wood-based exoskeleton	328
7.2.4	Technical details and applications	329
7.2.4.1	Extra-room.....	329
7.2.4.2	Balcony	330
7.2.4.3	Sun-space.....	331
7.2.4.4	Energy efficiency.....	331
8.	Conclusions and further steps	333
8.1	Athens case study	333
8.1.1	Seismic assessment.....	333
8.1.2	Preliminary design	334
8.1.3	Further steps.....	335
8.2	Italian case study.....	335
8.2.1	Seismic assessment.....	335
8.2.2	Further steps.....	336

8.3 Brasov case study	337
8.3.1 Seismic assessment.....	337
8.3.2 Further steps.....	338
8.4 PT-CLT tests	338
8.5 Integrated prefabricated components.....	338
Bibliography	341
Appendix.....	353

1. Introduction

The European Union (EU) has two hundred million housing-buildings, and they represent 27% of the energy consumption on the territory; therefore, the efficiency provided by energy interventions on these buildings is not negligible. In large urban areas, the suburbs represent much more territory than the historical centre, which is also densely populated. About 70% of the buildings were built after the Second World War (from the 1950s to the 1990s), and well before the entry into force of regulations on the reduction of energy consumption and in some areas also on the use of anti-seismic criteria. Mentioning only the Italian case:

- Law n. 373/1976, first regulations on energy saving
- Law n. 1086/1971, first anti-seismic design standards for reinforced concrete buildings
- OPCM n. 3274/2003, national classification of all the municipalities in four seismic zones

Specific studies [1] have reported that only the intervention on the envelope surfaces and the replacement of windows on existing buildings would result in an average energy yield of about 35-70 kWh/m² per year, however the cost-benefit assessments always show excessive depreciation times (up to 35-45 years without incentives).

Another important factor concerns the issue of seismic vulnerability that the Mediterranean countries (Greece, Italy, Spain, Romania, Turkey etc.) are facing, as areas with the highest occurrence probability [2]. The past seismic events have shown that this is relevant for reinforced concrete (RC) constructions, and especially for those conceived without anti-seismic criteria, which constitute a very substantial part of the building stock [3]. In this regard, it is interesting to analyse the amount of RC buildings built in the years prior to the update of seismic design procedures to evaluate the possible impacts of this categories, as introduced and described in paragraph 3.1 [4]. This relevant number of building stocks dominates the suburbs, and shares energy and structural issues with the historical heritage, consisting of masonry buildings.

While from the energy point of view, considerations regarding criticalities, retrofit solutions, and consequent possible improvements are similar for both RC and masonry buildings; considering safety, masonry constructions have a totally different behaviour than RC moment-resisting structures because they follow different conceptions. While RC structures are continuous and hyperstatic frames, masonry ones are composed by bearing walls which are subjected to logics of mechanics and equilibrium. In both cases, seismic safety is a relevant issue, which in territories such as Italy, where historical building aggregates constitute the majority of housing types, is crucial.

Therefore, interventions tackling these issues have been investigated and developed in the last decades in literature and practice, constantly taking into consideration the specificity of each existing building, the reference regulatory framework and the environmental characteristics of the territory.

In practices concerning the building sector, it is possible to simplify and differentiate two primary areas to trace a description of the characteristics of the existing heritage, usually a historical one, labelled as "premodern", and the other characterised by the introduction of RC technique (therefore starting from the first half of the twentieth century) that can be labelled as "modern" [5]. It is important to consider the condition of heterogeneity that defines the built heritage from the morphological, typological, material, contextual and temporal point of view. Therefore, it is important to comprehend the specificity that characterises every situation to develop the contents of the design without incurring in simplified univocal and prefigured solutions.

Confining the field of investigation to "premodern" buildings, load-bearing masonry constructions have defined the character of architecture and European buildings until the early twentieth century. In this context, from the constructive and structural point of view, in parallel to what happens in RC structures, verifications start with the definition of the resistance class of the materials used. During the assessment of bearing wall structures, a preliminary quality assessment of the elements (piers and spandrels) of the construction is performed, which cannot be reduced to the measurement of stress parameters to be

introduced in a consolidated analysis procedure. In fact, except for rare cases, the failure of masonry walls is achieved not by overcoming the resistance of the materials, but by the loss of the equilibrium condition and the triggering of collapse mechanisms. This quality assessment must comply with the "rules of art", a codified set of rules and prescriptions that masonry constructions must respect. In bearing walls constructions the correspondence between geometry and structure remains inseparable [5].

The case of "modern" constructions is different. The gradual transformation induced by the theory and practice of RC in construction techniques in Italy (concept expandable to the European territory) of the first half of the twentieth century is accompanied, in the later phase of post-war reconstruction, by the request for an optimisation of construction processes in order to provide a better response in terms of cost-benefit, or economic return on investment. From the technical-constructive point of view, the greater lightness observed in terms of linear structural members and the characterisation of secondary construction elements, such as curtain walls and floors, determine and modify the incidence of the mass. The acceleration impressed by the demands of post-war reconstruction prompted to modify the entire building process with a substantial standardisation of building typologies and technical practices. A new constructive "conception" was created and developed, which originates from the Anglo-Saxon punctiform skeleton light constructions and from those of the Italian traditions mentioned above, and which with the combination of the hyperstatic RC frame with masonry infills, witnesses a progressive reduction of the thickness of the envelope. In the context of the RC moment-resisting buildings, the primary issues concern the structural morphology, the construction type and the physical-mechanical characteristics of the materials [5]. The study carried out is mainly focused on aspects inherent to moment-resisting buildings as they are better suited to collaborate with external continuous structures such as the one presented in this work.

Within this complex and heterogeneous framework, the impossibility of proposing a unique solution that satisfies all needs is evident. The panorama of retrofitting interventions is, in fact, wide and flexible in order to answer each specific problematic situation with the required improvement. Therefore, the intent of the following research is to study the possibilities conferred by a specific intervention strategy that does not want to replace consolidated practices, but to constitute an advantageous alternative for specific cases that comply with the requirements needed for its use. Among the key points of the European project in which the research is inserted (see Section 3.3.2), building exclusively outside the existing perimeters, and introducing a synergy of intents are the main performers. The pivotal point of the project is in fact the desire to guarantee a triple improvement: structural, energy, and architectural.

Sections 2 and 3 introduce the existing context, from a seismic and energy point of view respectively, by framing the concept of seismic risk, mentioning the areas that are most characterised by it in terms of exposure and then the vulnerability of the buildings concerned. In response to this first contextualisation, the most widespread strategies in practice and in the bibliography are quickly presented and evaluated in their main aspects, so as to constitute a comparison and context of application for the introduction of the strategy being researched. Secondly, because of the necessary integration with the technological and energy efficiency aspects, after a statistical evaluation of the buildings eligible as target application, also the common problems and techniques of energy improvement are introduced, paying particular attention to those best experiences that aim at the creation of integrated systems, with the objective of obtaining a synergy of multiple benefits on existing buildings and constituting the state of the art for the introduction of the European project that contextualises the object of the research, Pro-GET-onE.

Once the intervention strategy has been defined, case studies are presented, from bibliography and practical experience (in Section 4), which constitute, from a structural point of view, the best examples of similar applications and therefore represent the state of the art for Section 5.

Chapter 5 presents all the analyses carried out by the author for the evaluation of seismic improvement on three case studies (indicated by the European project), varying the conformation of the external structures, the types of analyses carried out and the main material with which it is made. Proceeding in the proposed order, three feasibility studies are shown, based on the selection made by the European project consortium partners. The first one is focused on the student house in Athens, object of the prototype

construction, which foresees the use of steel as the most widespread and consolidated material for seismic strengthening interventions. Thanks to the inputs of the partner ALIVA Srl, who provided the know-how and the cross-sections of the external structure, the second section (5.2) compares the use of structural aluminium to the aforementioned steel solution. The last case study presented was the subject of the research carried out at the Technical University of Munich (TUM) and involved the change of the metallic frame structure initially envisaged by Pro-GET-onE, proposing a more sustainable alternative in cross-laminated timber (CLT) panels. This alternative solution was developed in its structural, architectural technology and energy efficiency application by the author.

In particular, a specific connection provided in the designed integrated system was the result of an adaptation of an analytical model previously studied for different applications. For this reason, Section 6 describes the laboratory experience carried out at TUM (in the final phase of the research), in order to prove the hypotheses previously put forward from a theoretical point of view and consequently enhance the results obtained, regarding the structural wood alternative. In addition, the test results constitute themselves material for similar future applications of the system, even in other contexts of intervention. The moment-rotation-behaviour of a post-tensioned (PT) joint between cross laminated timber (CLT) panels was analysed with a series of static bending tests. The timber joint, providing two horizontal sides, supported was loaded on the vertical element in order to apply a moment to the two interfaces of the connection. The tests were conducted with various tendon forces, from 150 kN up to 300 kN, varying the inner timber element and the joint configuration. The maximal allowable vertical load to be applied was estimated, using an adapted analytical model, conferring positive and feasible results, always on the safety side. The tests showed a self-centering behaviour of the proposed joint which was able to withstand all applied load cases without any severe damage.

The manuscript concludes with a presentation of the architectural technology aspect of the integrated system. The author has collaborated since the beginning of the European project in the realisation of the technological system, adapting it to the proposed structural system and vice versa, thus developing two alternative applications for the integrated system with a steel external structure and with a wooden one.

The workflow involved collaboration with the entire European project consortium for the architectural design of the steel solution developed for the student house in Athens. The main inputs were received for all integrations with the technical systems, and for the details of the extra-room and sun-space solutions. The latter were received by the TUM researchers and integrated into the main design by the author that managed all the eventual clashes with the structural components, thus developing the alternative solutions for the balcony on the same case study, realising the whole architectural design presented in the Appendixes, and used as the basis for the subsequent executive phase. On the other hand, the wooden architectural solution presented at the end of the work was developed by the author during the stay at TUM and presented as an eco-friendlier alternative option.

2. The seismic issue in existing buildings

Seismic hazard depends on the territory in which the buildings are located. In Europe, with particular reference to the Italian context, historical, economic and social factors have led to heterogeneity in building types. It is possible to notice the coexistence of monumental buildings, historical buildings characterising entire villages and more recent constructions, in masonry or concrete, which have often undergone interventions and extensions over time, often without considering the seismic vulnerability. Taking the Italian case as an example and analysing the 2011 ISTAT census [6], it is possible to find that about 60% of Italian residential buildings were built before 1971, i.e. before the seismic regulations. Moreover, the years immediately preceding and during the validity of that law were characterised by an economic upswing and the consequent increase in construction of buildings. It can be seen on the graph in Figure 26 in section 3.1.1, that in the 1960s and 1970s alone there was an increase in buildings of 35%. This growth is also accompanied by the phenomenon of building speculation which is often related to poor construction characteristics and consequent low structural seismic performances; a trend also reported in other countries in Europe and Turkey [7]. Since the 1980s there has been an abrupt change in the trend with a significant reduction in the number of buildings, even more evident from the new millennium onwards, which is increasingly directed towards philosophies of reuse of existing buildings and city centres, often depopulated, and consequent policies of urban regeneration and densification.

2.1 Introduction on earthquakes

The earth sphere (6'371 km radius) consists of several layers, core, mantle, and crust on the surface. The latter layer consists of plates that are constantly moving on a fluid surface. Where they are in contact with each other there are mountain ranges, volcanoes and it is where most seismic events are generated. The theory of tectonic plates connects the earthquake to the accumulation of energy due to the sliding of crust portions (faults). When deformations exceed the material's strength, the energy is discharged through a seismic event. The point where energy is released is called focus or seismic hypocentre. While the vertical projection on the surface of the focus is called epicentre and usually coincides with the most stressed point and, hence where most damages occur. The entity of the damages does depend not only on the distance to the epicentre of the event but also on several territorial and anthropological factors. The seismic risk is defined as a product of three components.

- Hazard – The expected event with a certain intensity and return period at a given site.
- Vulnerability – Depends on the quality of the structures. The assessment is based on the damage occurred.
- Exposure – Depends on the anthropology of the territory. Increasing the density of structures in a certain place is increasing its seismic risk. It depends also on the function of the building itself.

Seismic hazard at a site generally refers to a series of failure phenomena such as ground shaking, fault rupture, inundation due to earthquake-induced waves, soil liquefaction and landslide. Usually, every building, depending on its construction site should be designed or retrofitted on the basis of these major events. However, ground shaking associated with energy release from the faults is considered as the most dangerous possibility that determine the design loads. When energy is released, it turns into waves propagating from the focus in all directions. The waves that are generated in the first instance are of dual nature, compressional and transverse (P and S-waves), depending on whether they generate deformations respectively in the direction of the wave or perpendicular to it. On the last solid layer, surface waves are generated (Love and Rayleigh waves), which represent what men perceive during an earthquake. These have wavelengths greater than the previous ones and they drag the surface in their movement, causing damages (Figure 1).

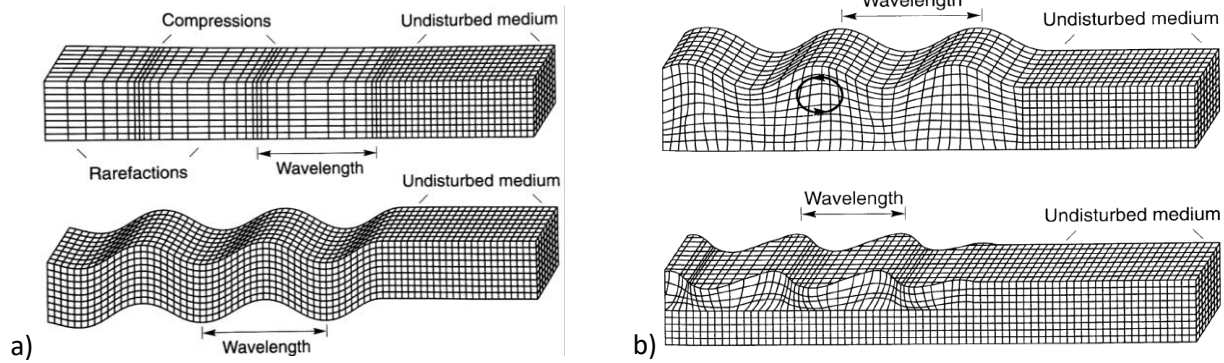

Figure 1 – Deformations produced by seismic waves. a) P and S-waves; b) surface waves (Love and Rayleigh) – Source: [8]

Since 1935 Magnitude (Richter) has been used as a measure of the intensity of earthquakes. The highest magnitude value attributed to an earthquake to date reaches 9.5 in Chile (1960), while in Europe the highest magnitude earthquake event (8.7) occurred in Lisbon in 1755.

One of the principal measurement values is the ground acceleration. The predominant components are usually horizontal, described over time by accelerograms. Their knowledge allows to calculate the seismic response of structures and for this reason, seismic histories of the territory have been made by mapping each seismic event recorded, obtaining the expected seismicity from the found one. The forecast of the seismic event is entrusted to a probabilistic study that divides the territory into seismogenic zones. The hazard level at a site is therefore represented by all the earthquake faults that may affect the site as well as the range of earthquakes that can occur on each fault, recognising rare, large-magnitude earthquakes at near to far distance, as well as more frequent, medium-magnitude earthquakes at close distance. Studies demonstrate that the smaller earthquakes generally occur more frequently than those with high magnitude, with the consequent correlation between the return period of interest and the entity of the horizontal loads considered [9]. The higher the return period, the higher will be the reference acceleration. Zonation maps, usually developed for each country, estimate the shaking intensity for different hazard levels that correspond to different peak accelerations or spectral accelerations to define design spectra especially used for traditional force-based design approaches.

The European community has therefore devoted part of its resources to the theme of seismic risk by financing a series of projects for the creation of a common seismic hazard model for the Euro-Mediterranean area, for the assessment and reduction of vulnerabilities in our urban contexts, for speeding up data collection by allowing access to seismic data of the territory and buildings by creating new tools and guidelines.

2.2 Earthquakes in Europe

One of these European projects allows to frame the context in which the need for seismic improvement systems for existing buildings is highlighted, thus defining the context in which engineers operate. In the following, some results will be presented to describe the European seismic Hazard situation as defined by the SHARE project (Seismic Hazard Harmonization in Europe) [2, 10]. From 2009 to 2013 the SHARE project worked towards the development of a consistent model of seismic hazard covering Europe and Turkey. The resultant model complied with the application of the European seismic regulations for design of building in seismic zones, Eurocode 8 [11, 12] and consists of more than 500 maps displaying the ground shaking that is expected to be reached or exceeded over return periods ranging from 70 to 5'000 years for more than 120'000 on-land sites equally spaced every 10 kilometres [2]. The input used by the model has been harmonised from heterogeneous and disparate data sets from the whole Europe and Turkey. Therefore, a

new homogeneous earthquake catalogue (SHEEC — the “SHARE European Earthquake Catalogue”) has been settled. It consists of two parts based on two different time lapses: (a) 1000–1899 and (b) 1900–2006. Data has been collected from historical earthquake-recordings and from information gathered in the Archive of Historical Earthquake Data, after reassessing all the earthquake parameters, based either on raw macro-seismic data or on the existing, selected national and regional catalogues as described in [10, 13]. The catalogue was then extended to cover Central and Eastern Turkey for a more homogeneous hazard analysis. The assessment is documented as the SHARE earthquake catalogue for Central and Eastern Turkey (SHARE-CET) for the time-window from 1000 to 2006. The catalogue lists over 30'000 earthquakes in the magnitude range $1.7 \leq M_w \leq 8.5$.

The study carried out for the SHARE project involved the analysis of the main faults shifts (reason for seismic phenomena) to completion of the final model. The European database of seismogenic faults was specifically designed to fulfil the project requirements in terms of exploiting the wealth of geologic, tectonic, and paleo-seismic knowledge available in the scientific community. Starting from heterogeneous and disparate databases all over Europe, the inputs have been harmonized for the model. The maps are produced for frequencies of ground acceleration on rock conditions from 0.1 to 100 hertz, which spans the frequency range to which the built environment is vulnerable [10, 13].

The Harmonized hazard map of Europe, and the related models are the results of the cited project. This map reports the peak ground acceleration (PGA) values with 10% of probability of exceedance in 50 years, which means that a 10% probability of occurrence of another earthquake with this PGA in 50 years (nominal life of a regular structure) is foreseen. It corresponds to an average return period of 475 years (Figure 2).

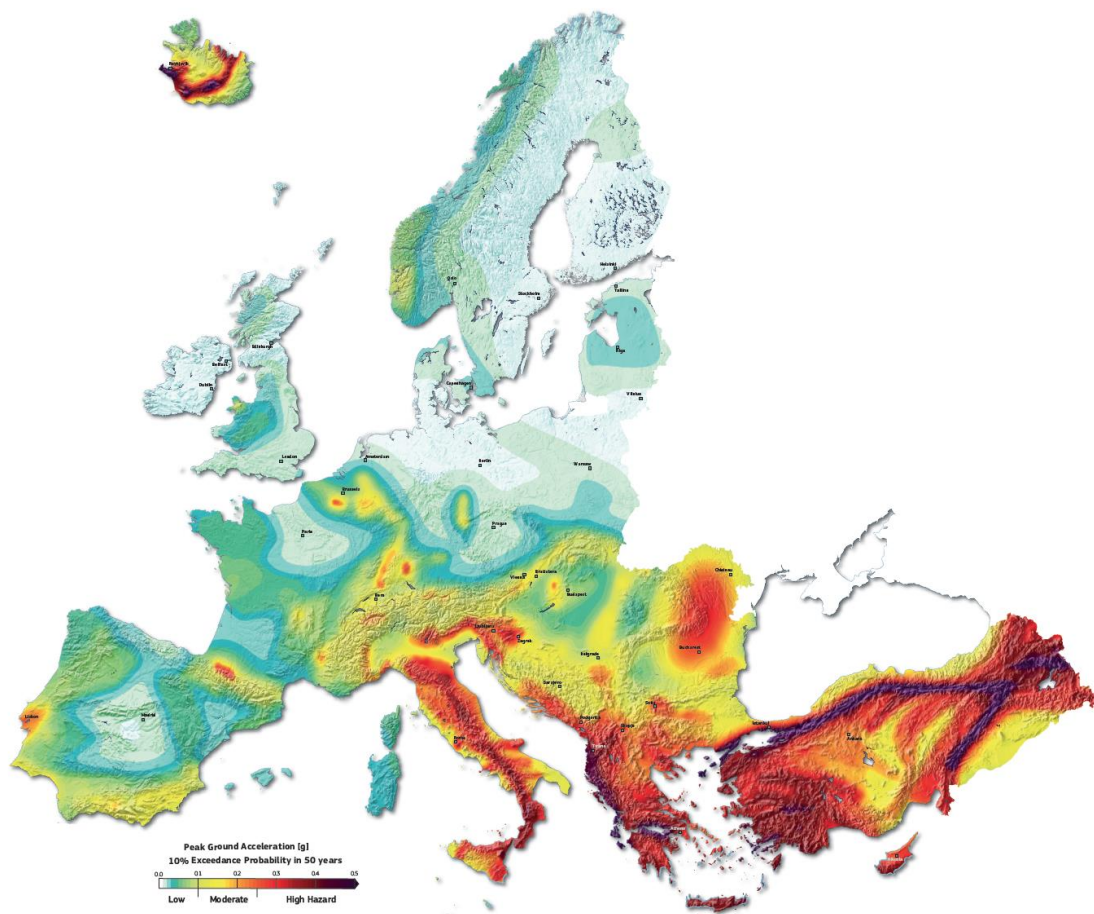

Figure 2 – European Seismic Hazard Map (ESHM13) displaying the 10% exceedance probability in 50 years for peak ground acceleration (PGA) in units of gravity (g). Cold colours indicate comparatively low hazard areas ($PGA \leq 0.1g$), yellow and orange indicate moderate-hazard values ($0.1g \leq PGA \leq 0.25g$), and red colours indicate high-hazard areas ($PGA \geq 0.25g$) – Source: [2, 10]

The milestone of the SHARE project was to compile harmonized datasets suitable for assessing the seismic hazard of the entire Euro-Mediterranean region by means of harmonized datasets to handle the inherent heterogeneity in the tectonic environments and data availability; this helped removing differences due to country-specific approaches and emphasized the differences due to actual seismic-tectonic diversity.

As can be seen in Figure 2 the regions with the higher seismic hazard are Italy, Greece, the south Balkans (Albania, Montenegro, Macedonia, and part of Romania), and Turkey. In these countries many earthquakes occur over a determined period of time, and characterised by a high level of magnitude, causing many casualties and damages to properties.

The Italian peninsula is located in the convergence zone between the Eurasian and African faults. In just over two thousand years it is estimated that Italy has been shocked by about 30'000 earthquakes of medium or strong intensity (citing only some recent examples: Amatrice 2016, Mirandola-Emilia 2012, L'Aquila 2009, and Molise 2002). Considering only the last forty years the economic losses caused by earthquakes account for approximately 135 billion of euros [14].

Greece is also subject to a high frequency of high-magnitude earthquakes. In the twentieth century it has been hit several times by damaging earthquakes as the one in Athens of 1999, while the most catastrophic event must be traced back to 1881, with a magnitude of 7.3, that caused more than three thousand victims [14].

A vast area subject to high seismicity is also located in eastern Romania, in particular in the Carpathian Mountains: there have been significant earthquakes in recent decades, with a magnitude above 7.0. The last catastrophic event happened the 4th of March 1977, with a magnitude of 7.4 and caused more than 1'500 deaths and serious damage to the Vrancea district [14].

Localised areas with medium seismicity are also found in France, Germany and Belgium. In Germany an area of moderate seismicity is located south of Stuttgart, Baden-Wurtemberg, and central-west of the country on the border to the Netherlands, where a strongest earthquake has occurred in the recent years (1992): the Roermond earthquake (M 5.8). It caused serious damage to buildings in the area. In the Netherlands and Belgium there is an average seismicity, with small areas where medium-sized seismic events occur repeatedly [14]. In particular, the gas extraction from the Groningen gas fields in the northern Netherlands has led to localised earthquakes (more than 1000) which were projected to become more severe. The social impacts experienced by residents included damage to property, declining house prices, concerns about the chance of dyke breaking, feelings of anxiety and insecurity, health issues and anger [15].

Further seismic areas in Europe are southern Spain and Portugal, located just like Italy and Greece along the tectonic edge between the African and Eurasian fault. Here the return periods are longer with a consequent lower seismic danger considering short time intervals (for example 50 years). It is also reported that one of the most devastating earthquakes in European history was that of Lisbon in 1755, which caused a devastating tsunami on the continent, heavily hitting the Spanish Andalusia. Also the Pyrenees area, between France and Spain, is subject to severe earthquakes with long return times [14].

The present study has been focused on European countries presenting higher seismic risk (Greece, Italy, and Romania) due to the objectives of the project and the consequent determined choices over the case studies. Reference to the results of the SHARE Project regarding the characterisation of the seismic hazards for each specific case study has been used together with an evaluation of the requirements from standards (European and Italian).

2.3 Vulnerabilities of existing reinforced concrete (RC) buildings

When subjected to earthquake ground motions, structural RC systems have dynamic responses that are primarily addressed with acceleration and displacements. Parameters as stiffness, mass, strength, and damping determine dynamic response and expected performance and are the basis to understand how to retrofit existing structures. Observations of past earthquakes have led to the conclusion that the lateral load

strength of the structure is not a sufficient index to represent the safety of a building. The earthquake response of a building is influenced by characteristics of earthquake motion, structural configuration, dynamic properties, lateral strength, deformation capability of constituent members, foundation, soil-structure interaction, quality of workmanship, structure age and maintenance, and loading history [16]. This section introduces some basic concepts for the assessment of existing structures in RC and then reviews the main issues that characterise them.

The majority of buildings that need to be renovated are relatively low-rise structures, characterised by the predominance of low vibration modes and where the estimations of displacements response for single degree of freedom (SDOF) oscillators can be extended to multi degree of freedom (MDOF) systems. An idealised oscillator has stiffness, mass, and damping properties equivalent to those of the MDOF system (structure). The predominant vibration mode is defined as $T = 2\pi\sqrt{M/K}$, where M is the mass and K is the stiffness. Peak absolute acceleration and relative displacement response caused by earthquake ground motions can be calculated depending on the vibration period (T) and the viscous damping [9]. Earthquake ground motions produce response spectra that could be described during time in terms of acceleration or displacement. Through an average of these responses smoothed design response spectra are derived and commonly used to guide the design of building and retrofit interventions in seismic area. Techniques that increase damping will reduce both the spectral acceleration and displacement demands (assuming unvaried mass before and after the retrofit). Procedures that stiffen a building (decreasing the period) tend to reduce displacement demands and may result in increases in spectral acceleration. Although, the response for most structures requiring rehabilitation is likely to be inelastic, meaning that the internal forces are limited by the structural strength and not determined directly by the ordinates of the linear response spectrum [9].

Passing from SDOF to MDOF RC structures, it is important to identify how the drifts are distributed over height, the position of the centres of mass and stiffness (and possible consequent torsional behaviour) and possible localised weaknesses through the load paths of the structural members. Every structural typology is typically characterised by its own deformed shape [9]:

- predominance of RC walls determines a deformed shape represented by a cantilever beam under horizontal loads, with inter-storey drifts relatively higher in the upper floors;
- controlled or not controlled (due to insufficient foundations) rocking systems determine a uniform displacement along the height of the structure;
- RC moment resisting frames see larger inter-storey drifts in the lower floors that decrease over height;
- systems that present a soft storey tend to have concentrated drifts in the localised floor;

with a general correlation between greater inter-storey drifts and amount of damages (Figure 3a).

Each existing building has its own lateral load resisting system characterised by the geometric and mechanical parameters of the individual elements (cross-section, material characteristics and quantity of reinforcement) and by the morphology within the planimetric distribution (position of the resistant elements within the structural form). Considering the translational stiffness of each structural element and its location it is possible to evaluate the position of the centre of stiffness (or resistance) which is normally compared with the centre of mass (evaluated considering the weights affecting each storey). The seismic loads depend on the magnitude of the masses and act along the directions passing through the centre of mass. When the centre of mass does not coincide with the centre of stiffness (Figure 3b), then a torsional moment affecting the whole structure must be considered for the global response and often results in significant vulnerabilities for existing dated structures. The resulting torsional action increases displacement demands in members away from the centre of stiffness, resulting in progressive localised damage that compromises the global behaviour [9].

Inertial forces trigger the dynamic response of the structure that must be supported by the resisting elements through a load path in different directions (Figure 3c). Weak and brittle elements along the load path may interrupt the flow of forces and cause failure of the structural system [9]. The assessment of existing structures must investigate the continuity and strength of elements along the load path from the force

generation points to the foundations. When the continuity or strength of specific elements is not sufficient, localised failure can occur. Conventional RC constructions should avoid concentrations of deformation and damage in localised areas. When deformation demands prematurely exceed deformation capacities, the resulting localised failures may lead to poor overall system behaviour. In moment resisting frame buildings, for example, if the inelastic action is concentrated in a single weak floor, a single storey mechanism (soft storey) occurs, resulting in the collapse of the structure. For this reason, for this type of structure, the strength-hierarchy indicates a distributed yielding over height (usually involving beams) and no single member or storey absorbing most of the seismic demand. Interactions with non-structural members also play an important role. Partial masonry fillings may result in shortened columns (constrained columns) generally prone to shear failure and resulting in a relatively brittle weak storey mechanism. The stiffness of each storey, depending on the lateral load resisting system, should also avoid large variations in stiffness between storeys to avoid concentration of loads in a few elements and consequent localised failures that interrupt the load path.

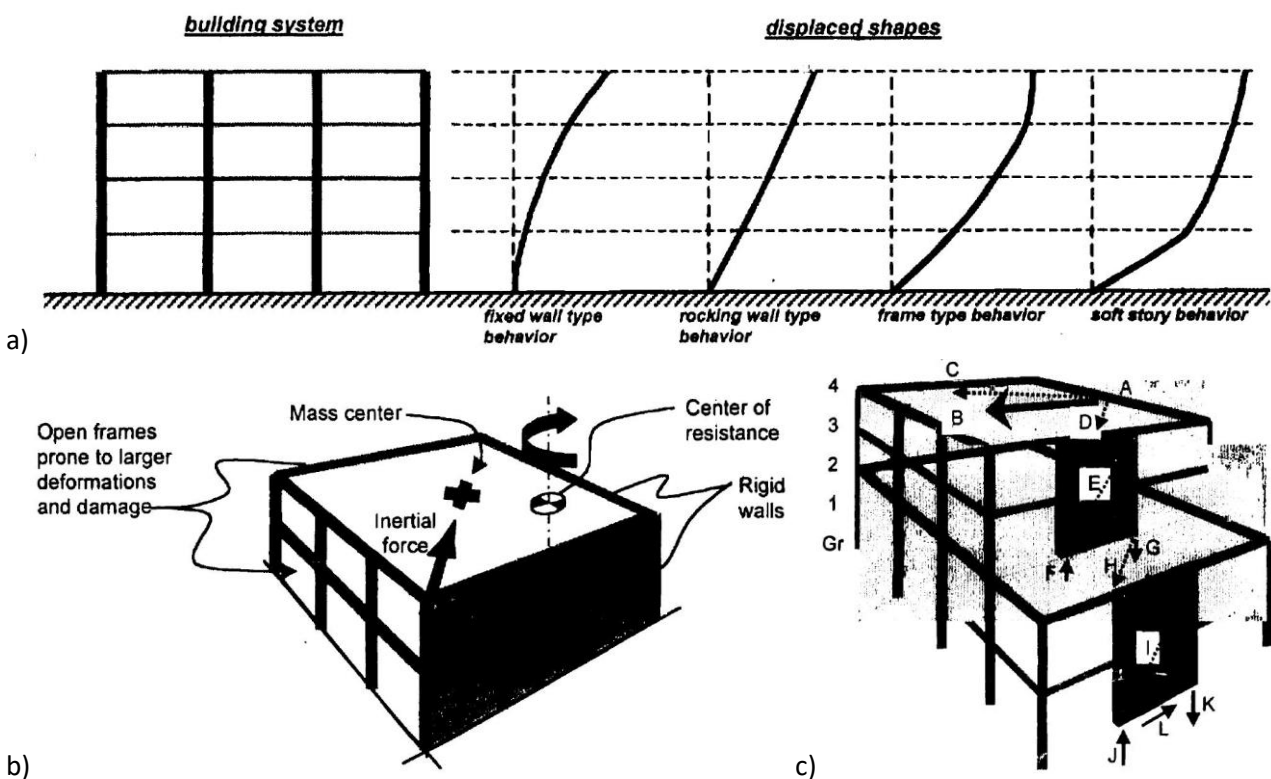

Figure 3 – a) Distribution of drift over height for typical lateral force resisting systems; b) torsional action on a building in which centres of mass and stiffness do not match; c) scheme of the load path of an idealised structure – Source: [9]

Unlike load-bearing masonry structures, RC buildings do not base their strength on the geometric area of the walls but rely on linear elements, forming a frame that exploits the synergic collaboration of concrete and steel. In fact, like masonry, concrete is a fragile material, which only thanks to the tensile strength conferred by the reinforcing bars, can withstand large stresses, even with geometrically small sections.

The behaviour of a RC building subject to horizontal actions can be analysed on three different scales [17]:

- behaviour of the constituent materials;
- behaviour of the structural elements;
- and behaviour of the structure as a whole.

The first scale involves durability intended as the ability of RC components to withstand time; or to be able to maintain its performance characteristics unaltered. Referring to the exposure classes for structural

concrete according to environmental conditions, four are the essential parameters on which durability depends: the minimum value of the characteristic strength of concrete, the water-cement ratio, the minimum cement content, and the thickness of the concrete cover. The deterioration of concrete can occur in different forms such as cracking, degradation of concrete, loss of concrete cover and corrosion of reinforcing bars. The causes that lead to the degradation of the material and the consequent vulnerability of a construction can be summarized as follows [18]:

- bad design or poor quality of the product. In this category are included a wide number of cases is included, designed for vertical loads only in areas successively declared seismic;
- wrong construction process and consequent occurrence of empty spaces in the structural elements;
- inadequate maturation processes;
- external causes of mechanical nature such as damages induced by mechanical service stresses; micro-cracks induced by thermo-hygrometric variations, dilatation/shrinkage;
- physical causes such as temperature variations and frost/thaw action for ice formation in the cement matrix and inert materials;
- chemical causes (due to aggregated alkali reaction, acidic environments and the presence of sulphates, etc.) which involves both the cement matrix (carbonation, leaching, disintegration by sulphate action, etc.), and the reinforcements;
- biological degradation (lichens, algae, etc.);
- degradation due to accidental events (impacts, fires, seismic events, etc.) that can reduce the load-bearing capacities of the structures or highlight previously hidden vulnerabilities.

Regarding the behaviour of structural elements, it may be different for columns, beams, walls, and beam-column joints, but in general construction details should be designed to prevent brittle failure (shear, beam-column joints) in favour of ductile failure (bending and eccentric axial force), thus providing adequate ductility. Unfortunately, this is not always guaranteed in existing buildings, especially in those designed with outdated standards where the size, spacing and strength of shear reinforcements were not adequate to actual design loads. Brittle or ductile failures are dictated by the characteristics of the materials, the size of the sections, the amount of longitudinal and transverse reinforcement, the static scheme and, as already mentioned, all those degradation phenomena that may involve the material. Brittle failures must always be avoided since they occur without warning and lead, depending on the number of elements involved and their position, to the collapse of the structure. They occur as a result of exceeding the strength of the materials and are often related to insufficient transverse reinforcement (stirrups), inadequate anchorage of both transverse and longitudinal reinforcement, or interaction with non-structural walls that reduce the deformable length of the columns (Figure 4a). In addition, when stirrups or ties are not close enough, splitting cracks may develop along the longitudinal reinforcement of beams or columns, resulting in loss of bond stress and weakening of the column and consequent system failures associated with weak storey mechanisms.

Ductile failure, on the other hand, is the criterion on which the design of limit states in seismic zones is based. The hierarchy of resistances induces the designer to prearrange the collapse of elements (bending over shear, beams over columns and joints) and then to predict the collapse mechanism. Ductile failures occur with deformations and can be monitored by reaching collapse through intermediate levels of damage that can lead to preventive safety measures. When a moment resisting frame is designed with the above-mentioned hierarchy, the beam-to-column joint must be carefully designed to support high stresses following beam yielding, in order to avoid diagonal cracking that reduces the stiffness of a building. This failure, when found in external joints, could lead to the collapse of the building, if the degradation of the joint is severe enough that spalling of the concrete leads to the loss of column support [9]. The deformation capacity of columns in bending is influenced by the level of axial force in the column and the amount of lateral reinforcement provided in the plastic deformation region. The overturning moment generated on the structure by the horizontal loads always influences the axial forces in the columns which can become extremely high in

compression, leading to failure in flexural compression, followed by the loss of the gravitational load capacity (Figure 4b) or being reduced with a consequent negative response on the stresses from the concrete side.

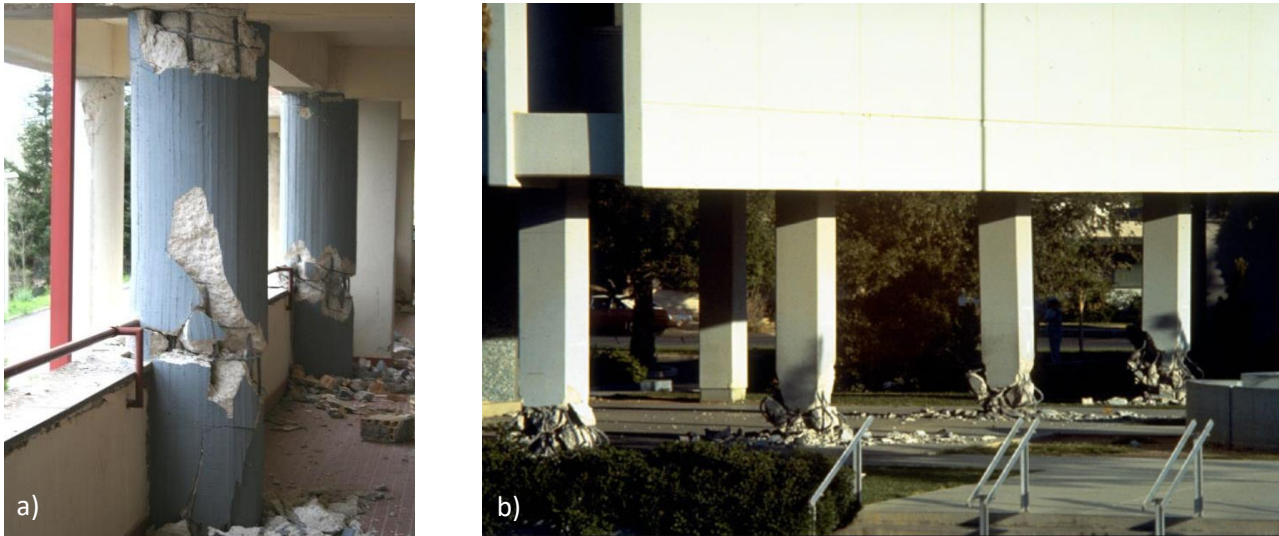

Figure 4 - a) Columns enclosed between partial infilling panels that caused lateral deformation to concentrate in a shorter length; b) adequate shear load path of interior and end walls until discontinuity shown at the ground floor; overturning moments under the end walls led to column failures – Source: [9, 19]

Finally, system aspects affect the global behaviour of a RC building and may concern the following main points [9, 17].

- Lack of strength or deformation capacity may occur during strong seismic motion, before or after the formation of plastic mechanism under lateral loading, or when second order effect (P-delta) causes instability after significant deformations. The complex interrelation between ground motion, building resistance in terms of stiffness and strength, and building deformability is commonly simplified for design and assessment purposes, considering that buildings with low deformation capacity require high stiffness and strength while those with larger deformation capacity perform well with lower stiffness and strength. However, as regards the prevention of damage from frequent seismic actions buildings with high resistance are likely to have less damage compared to buildings with low resistance and extended deformation capacity.
- Compliance with plan and elevation regularity criteria are often one of the more common risky conditions for dated buildings. Where the stiffness and the associated strength are drastically reduced passing through storeys along the height, earthquake-induced deformations tend to concentrate at the flexible or weak storey implying mechanisms like soft storey and the collapse of the structure. This situation is particularly common in multi-storey residential buildings in urban areas, in which the ground floor is often used as open space, for commercial facilities or garages. The situation can also occur in intermediate floors of old buildings where the same collapse mechanism has occurred. Where regulations with respect to shear reinforcement were not sufficiently stringent, brittle shear failure could occur in columns. This type of failure may affect one column and is then accompanied by the loss of resistance to lateral and vertical loading, which is distributed over the others causing consequential failures (Figure 5a). In newer structures where there is sufficient shear reinforcement, the shear failure is delayed, and the collapse foiled. When irregularities affect the horizontal distribution of resisting elements, eccentricity between centres of mass and stiffness causes torsional stresses that during earthquakes increase damage to structures located on the more deformable side. In these cases, the design of the retrofit should have as one of its objectives to balance strength and mass and to provide substantial torsional resistance for torsional effects.
- Inadequate rigid storey diaphragms interrupt the load path and represent sometimes the weak link in the system. The structural diaphragms are, in fact, the direct connector between the floor masses,

which generate the horizontal forces during the seismic event, and the lateral load resisting system and should be able to transfer the related shear loads.

- Interactions with non-structural components may represent a problem, both for the global behaviour and for the single structural element. In the former case, the presence and location of masonry or concrete infill walls and stairwells result in additional stiffness, sometimes unintended, that may lead to adverse system behaviour. The masonry infill walls may have a brittle behaviour, resulting in the failure of a single storey due to the drastic reduction in stiffness, or when they are not present at ground floor level only, leaving a flexible and weak first floor.
- The high vulnerability to storey drift (inter-storey deformation) implies damage to non-structural elements, such as partitions, windows, doors, and mechanical systems (Figure 5b). In fact, inhabitants may be frightened or injured by the collapse of these parts and the cost of repair works is often governed by the replacement of non-structural elements, rather than by repair works of structural elements.
- Changes to the structural system over time, such as the addition/removal of structural or non-structural elements and changes in occupancy may significantly increase dead or live loads that may overstress the system and reduce seismic resistance. In these cases, a field inspection of the building or the application of destructive or non-destructive testing may be advisable. Effective ways to avoid this problem are to increase the stiffness of the structure (by inserting bracing systems, structural walls or improving the performance of non-structural elements) or introducing a gap between the infill and the bearing structure to allow relative displacements but avoiding out-of-plane overturning.
- Pounding of adjacent buildings may determine poor structural performance and localised damages, especially when the floor slabs of adjacent buildings are not horizontally aligned to each other (Figure 5c).
- Failure at the foundation level may be related to liquefaction and loss of bearing capacity or tension (Figure 5d), fault rupture, soil compaction or differential settlement at cut and fill locations.



Figure 5 – a) Example of soft storey mechanism in L’Aquila (Italy), 2009; b) ejection of the external panel and bending collapse of the interior one; c) pounding between new and old building in L’Aquila (Italy), 2009; d) Overturning residential building in Niigata City (Japan) due to liquefaction of sandy soil in 1964 – Source: [9, 19-21]

2.4 Seismic strengthening strategies for RC buildings

As reported in paragraph 2.2 the Mediterranean countries of the European Union are indicated as the areas with the highest probability of natural earthquakes in Europe [2]. In these areas, recent seismic events have shown how relevant the issue of seismic vulnerability for existing RC buildings is, as many of them were designed without any reference to seismic criteria or with outdated codes. Many structural deficiencies have been recorded over time due to past seismic events as mentioned in paragraph 2.3 [7, 9, 17-23]. In addition to economic loss, seismically deficient buildings may cause injuries and casualties. By now, the earthquake engineering research community has dedicated significant efforts to the development of several techniques for strengthening existing RC buildings [24, 25]. Seismic improvement solutions for existing RC buildings differ according to the number of resistant elements involved and the intervention strategy adopted. There are local interventions which may involve strengthening structural elements (beams, columns, and joints), correcting seismic joints, securing vulnerable elements and/or eliminating any weak floors (soft storey). Otherwise, global interventions modify the behaviour of the building by inserting additional structural systems capable of resisting or isolating the seismic action. Through the use of one or more techniques, two main strategies are outlined (Figure 6). One concerns the increase in strength and resistance while the other reduces the demand of the structures involved. In order to select the right intervention, several criteria can be considered (e.g., technical reason, practical and/or socio-economic aspects).

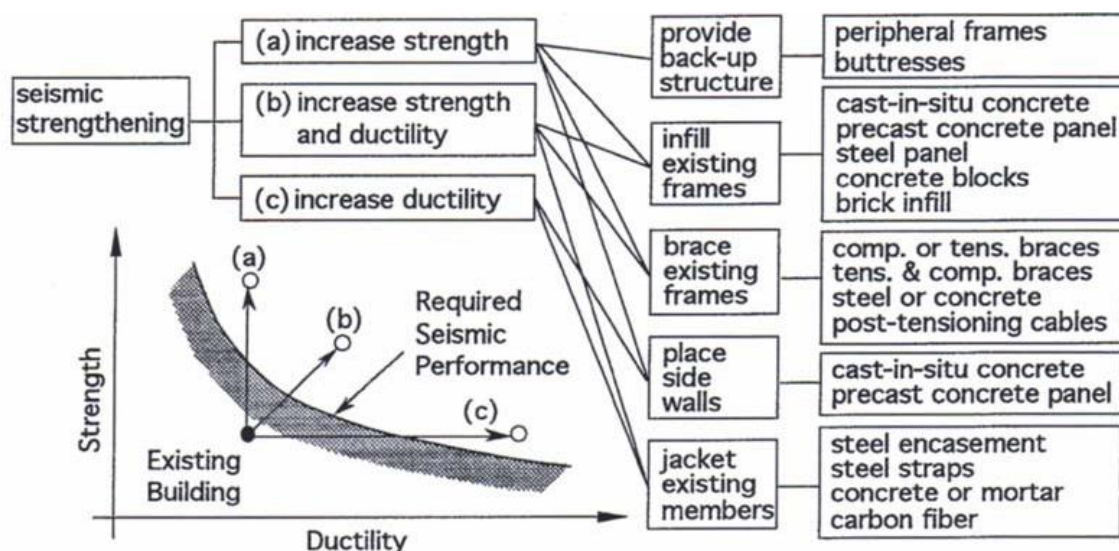

Figure 6 – Scheme representing the seismic strengthening strategies aiming at increasing strength, ductility or both – Source: [26]

Existing buildings designed with outdated requirements, often experience brittle failures of structural elements before reaching flexural yield or exploiting small deformations. For such structures, the strategy is to limit the deformation or force demands on the brittle components by adding lateral stiffness or reducing the seismic input. The lateral stiffness can be increased by placing structural walls, steel bracing, or new moment-resisting frames. This solution is particularly effective when the structure has many structural members known to fail at a small lateral deflection. In this case, jacketing the existing members can be very costly and disruptive to the function of the building, whereas the placement of new lateral bracing elements around the perimeter of the building could minimise intrusion into the interior spaces while ensuring structural improvement. External bracings have multiple positive effects, such as increasing strength and stiffness, reducing the deformation demand and, if specifically designed, can correct irregularities, but, as a disadvantage, can lead to an increase in force demand which can lead, in some elements, to failure. They normally add strength to the building to resist the additional forces, but the load paths must be examined to

ensure that seismic inertial forces developed within the building can reach the new structures and foundations.

Seismic isolation systems are highly effective in protecting brittle structural elements and acceleration-sensitive building contents, as they act as a filter between the ground and the superstructure (or between different levels of a determined structure) by shifting the vibration period to the downward part of the acceleration spectrum. However, lightweight structures may not be suitable for rehabilitation with these devices, since relative displacements could not be prevented and because the isolators do not resist the tensile forces that may occur, due to overturning actions in slender structures.

Energy dissipation devices aim to increase the damping of the structure. Hysteretic energy dissipation can be exploited when the device can deform beyond its yield strength. Therefore, the yield deformation of the device must be much smaller than the deformation capacity of the structural members. This results in a requirement in terms of drifts on the existing structure, at such levels as to activate the devices.

Even a simple reduction in mass can be an effective retrofitting technique to reduce the displacement demand in existing buildings. By reducing effective mass, the vibration period of the structure is shortened along with the inertial forces.

Sometimes, techniques aimed at decreasing deformation demands may be structurally ineffective or unsuitable for the specific case. In such cases various approaches can be used to increase the deformation capacity of localised members. This strategy involves local interventions on structural members to enable them to sustain certain levels of deformation. The deformation capacities in these cases are increased without appreciably changing the stiffness or strength of the overall system and, therefore, without changing the displacement requirements. The capacity of structural elements can be increased by shifting brittle failure modes to ductile failure modes, jacketing them either new concrete, steel, or composite materials.

The table below from [27] indicates respectively beneficial or detrimental effects for the main strengthening strategies. It shows that some measures may have different consequences and, that some of them may lead to unfavourable effects which have to be considered (Table 1).

Table 1 – Effect of local and global retrofit measures on building properties – Source: [27]

		Strength	Stiffness	Ductility	Irregularity	Force demand	Deformation demand
Local measures	Concrete jacket	✓	✓	✓		✗	✓
	Steel jacket	✓		✓			
	FRP jacket	✓		✓			
	Post-tensioning	✓		✓			
	Strength reduction	✗					
Global measures	New frames, shear walls, braces	✓	✓		✓	✗	✓
	Mass removal				✓	✓	✗
	Partial demolition				✓	✓	
	Isolation				✓	✓	✓
	Dampers		✓			✗	✓
	Connect independent sections				✓		

Referring to the European regulatory context, specific indications on interventions on existing buildings have been introduced [11]. Requirements are indicated to guide the engineer when determining the level of knowledge, identifying the technical criteria to select the right strategies and indications on the most common types of intervention (Table 2).

Table 2 – Criteria for structural interventions on existing buildings – Source: [11]

Technical criteria	<p>The selection of the type, technique, extent, and urgency of the intervention shall be based on the structural information collected during the assessment of the building.</p> <p>The following aspects should be taken into account:</p> <ul style="list-style-type: none"> ▪ all identified local gross errors should be appropriately remedied; ▪ in case of highly irregular buildings (both in terms of stiffness and over strength distributions), structural regularity should be improved as much as possible, both in elevation and in plan; ▪ the required characteristics of regularity and resistance can be achieved by either modification of the strength and/or stiffness of an appropriate number of existing components, or by the introduction of new structural elements; ▪ increase in the local ductility supply should be affected where required; ▪ the increase in strength after the intervention should not reduce the available global ductility; ▪ specifically, for masonry structures: non-ductile lintels should be improved, out-of-plane horizontal thrusts against walls should be eliminated.
Type of intervention	<p>An intervention may be selected from the following indicative types:</p> <ul style="list-style-type: none"> ▪ local or overall modification of damage or undamaged elements (repair, strengthening or full replacement), considering the stiffness, strength and/or ductility of these elements; ▪ addition of new structural elements (e.g., bracings or infill walls; steel, timber or reinforced concrete belts in masonry construction; etc.) ▪ modification of the structural system (elimination of some structural joints; widening of joints; elimination of vulnerable elements; modification into more regular and/or more ductile arrangements); ▪ addition of a new structural system to sustain some or all of the entire seismic action; ▪ possible transformation of existing non-structural elements into structural elements; ▪ introduction of passive protection devices through either dissipative bracing or base isolation; ▪ mass reduction; ▪ restriction or change of use of the building; ▪ partial demolition. <p>One or more types in combination may be selected. In all cases, the effect of structural modifications on the foundation should be taken into account.</p>
Non-structural elements	<p>Decisions regarding repair or strengthening of non-structural elements shall also be taken whenever, in addition to functional requirements, the seismic behaviour of these elements may endanger the life of inhabitants or affect the value of goods stored in the building.</p> <p>In such cases, full or partial collapse of these elements should be avoided by means of:</p> <ul style="list-style-type: none"> ▪ appropriate connections to structural elements; ▪ increasing the resistance of non-structural elements; ▪ taking measures of anchorage to prevent possible falling out of parts of these elements. <p>The possible consequences of these provisions on the behaviour of structural elements should be taken into account.</p>

A brief overview of the existing intervention strategies for retrofitting RC buildings is presented in the following paragraphs to identify and describe the existing solutions and to highlight for each of them advantages and disadvantages considering technical and non-technical criteria.

2.4.1 Local interventions

The externally bonded strengthening made of RC, steel or FRP are defined as local reinforcement techniques. These interventions can increase strength and ductility at the expense of a significant invasiveness for the users of the building. The greater or lesser use of this strengthening techniques determines the extent of the impact on the overall behaviour of the building. In general, these interventions allow the members to satisfy the requested demand in term of displacement, increasing the global ductility without substantially varying the stiffness of the structure.

The local interventions can be defined as superficial or structural. The first category provides the restoration of degraded concrete giving back the integrity of RC cross-sections, renewing the reinforcement with new bars and improving the durability of the element. Structural interventions aim at increasing the strength or the deformation capacity of structural elements through the addition of new material. It is important to underline that the structural interventions are made after superficial ones. The application of new material can be done only after a careful check and restoration of the existing surfaces. Restoration of degraded concrete and reinforcement consist of reconstructing the cross-section, restoring the structure with only the addition of controlled-shrinkage mortar and the possible insertion of new reinforcement bars (Figure 7) [18].



Figure 7 – Restoration of a degraded concrete column – Source: [28]

Among structural local interventions a list of solutions is provided below. An additional subdivision can be made to solutions that provide traditional materials and technique (*Beton Plaqué* and steel angular brackets) and solutions that use either innovative materials (FRP, SRP and SRG) or traditional ones with innovative techniques (CAM).

The *Beton Plaqué* system reinforces the existing members by gluing steel plates with structural epoxy adhesive in paste. The thickness of the metal plates must be limited, to avoid non-adhesion and excessive stiffness. In some cases, bolts are inserted connecting the plates.

Following the same conception, a metal jacketing system is composed of four angular profiles embracing the corners of the existing member connected repeatedly by steel plates along the sides. A layer of mortar is foreseen to distribute the stresses on the contact surface (Figure 8a). The CAM system instead, uses high resistance galvanized steel strips (thickness 0.8 – 1.0 mm and width of 18 – 20 mm), applied on top of four rounded steel angles, arranged on the corners of the column, and/or beam, both to transfer the stresses conferred by the strips, and to reduce friction during tensioning. In fact, the strips must close around the structural element so as to be subsequently tensioned, putting the entire element in compression along its development (Figure 8b) [18]. The latter solution allows to increase the bending resistance of members and avoid shear brittle failures at the ends of columns and beams [23].



Figure 8 – Steel jacking of existing reinforced concrete members. a) A traditional approach; b) the CAM system – Source: [29, 30]

In recent years the use of a fibre-composite material for jacking is increasingly widespread. It is carried out using strips, sheets and bars in carbon fibre, aramid, and glass. The application of composite materials must always be preceded by a careful analysis of the elements. In fact, where necessary, reconstructing the concrete cover and rounding off the sharp edges is indicated, in order to reduce stress concentrations and consequent FRP fractures. Depending on the arrangement of the fibre-composite strips, certain performances can be strengthened [18]. To increase the bending strength, it is necessary to apply one or more layers on the tensed edge of the affected member and, if it is not sufficient, also on the sides. In case of shear reinforcement, the fibre-composite strips can be arranged discontinuously or continuously, all around the affected section or, alternatively, on the three exposed sides at the intrados. In this case thickness, width, distance, and angle with respect to the axis of the element are the variables that determine the entity of the improvement. The torsional reinforcement can provide either a continuous or non-continuous envelopment in which the fibres are arranged orthogonally to the axis of the element. Finally, it is possible to confine joints and columns continuously, covering respectively the joint or the column entirely, or discontinuously, reducing its effectiveness (Figure 9).

The main results of FRP applications are the increase in ductility and in eccentric axial force resistance, validated by the extreme lightness of the material. However, a great limitation related to the loss of ductility of the reinforced structural element emerged, both for the mechanical behaviour of the elastic-brittle type reinforcement, and for the onset of premature crisis phenomena, such as the detachment of the reinforcement from the substrate [23].



Figure 9 – Examples of FRP strengthening applications on RC members. Source: [31]

Finally, alternatives to FRP strips are the SRP (Steel Reinforced Polymer) and the SRG (Steel Reinforced Grout). These are fabrics made with high tensile strength steel wires intertwined to form ropes, dipped in an epoxy resin (SRP) or a cementitious matrix (SRG). They can be applied as bending and compression reinforcement

of RC beams and joists [32, 33]. The use of steel inside the composite material allows to increase the ductility of the reinforced member to a higher level compared to FRP, favouring broad prospect of use [23].

2.4.2 Global interventions

Interventions that directly affect global behaviour provide the insertion of resistant elements such as RC shear walls, infills, or steel bracings with the aim of increasing stiffness and capacity of the structure. This increase can affect ductility or resistance depending on the chosen design solutions (Table 1).

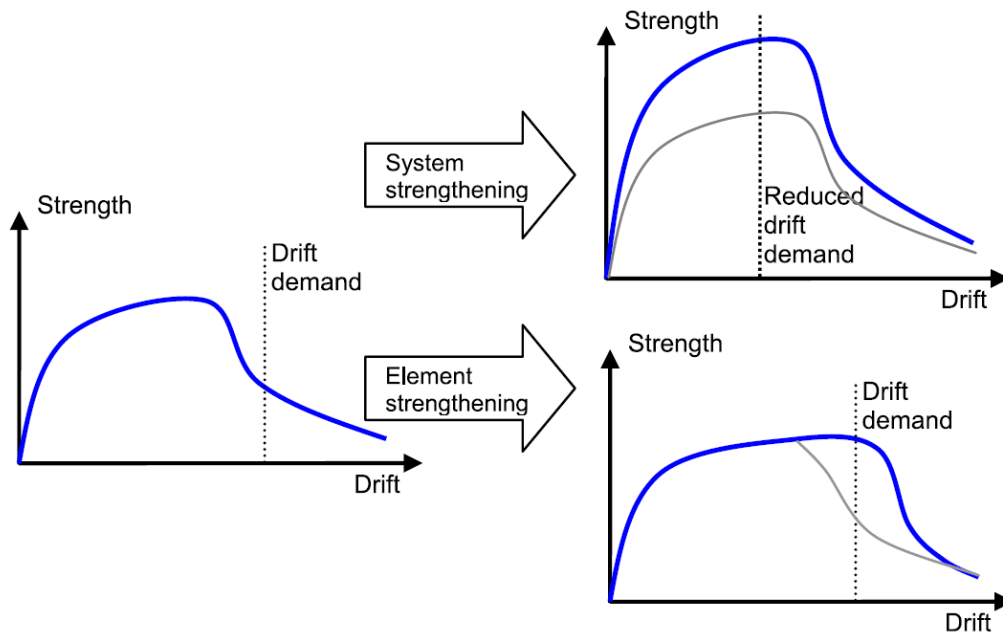

Figure 10 – Different approaches determine different assessment on capacity curves – Source: [34]

The purpose of strengthening methods is to ensure that the displacement demand of a building remains below its displacement capacity. When a global strengthening is provided, new elements are added to the existing structure to improve its global performance. With an increase in stiffness, the natural period of vibration decreases. This results in a decrease in the amount of horizontal displacement that the building must achieve to resist an earthquake. When the structure is stiff enough, it will no longer be able to achieve the displacement that corresponds to its collapse. New elements increase the capacity under horizontal loads and, therefore, require greater ground motions to yield the structure. In fact, an increased stiffness does not only prevent the collapse, but also delays structural damages. Local interventions are aimed to punctually extend the capacity of the inadequate elements without undertaking major changes in the load-bearing system of the building. Therefore, negligible changes take place in the characteristics of the entire structure, such as stiffness and mass and no significant changes in the displacement demand after the members strengthening must be expected (Figure 10).

As reported in [27], unreinforced masonry is commonly used as infill in RC frame buildings (Figure 11). These infill walls were often pointed as weak elements during earthquakes. Due to their brittle behaviour and small or no ductility, they suffer damage, ranging from cracking to crushing and eventually to complete collapse [35]. However, it is recognised that they have a beneficial effect on the seismic performance of buildings since they can reduce lateral displacements by more than two times compared with the bare frame. This dependence is experimentally registered with velocimeters in other specific studies aimed at the dynamic characterisation of RC existing buildings [36].

In literature it can be found that the development of strengthening techniques for infill walls by means of jacketing, FRP sheets, and bars has been made together with experiments on the use of precast concrete elements. Lee and Woo investigated the effect of masonry infills on the seismic performance of low-rise RC frames without seismic detailing [37]. For this purpose, a two-bay three-storey masonry-infilled RC frame was selected and a 1:5 scale model was constructed according to South Korean practice of non-seismic detailing. A series of earthquake simulation tests and a pushover test were performed on the models showing that the drifts of a partially infilled frame were greater than those of the fully infilled one under the same level of input ground motion, while the maximum base shear in both cases was increasing compared to the bare frame. Generally, it can be observed that the masonry infills contribute to the increase in the global stiffness and strength of the structure, whereas they also result in the increase of earthquake inertia forces.

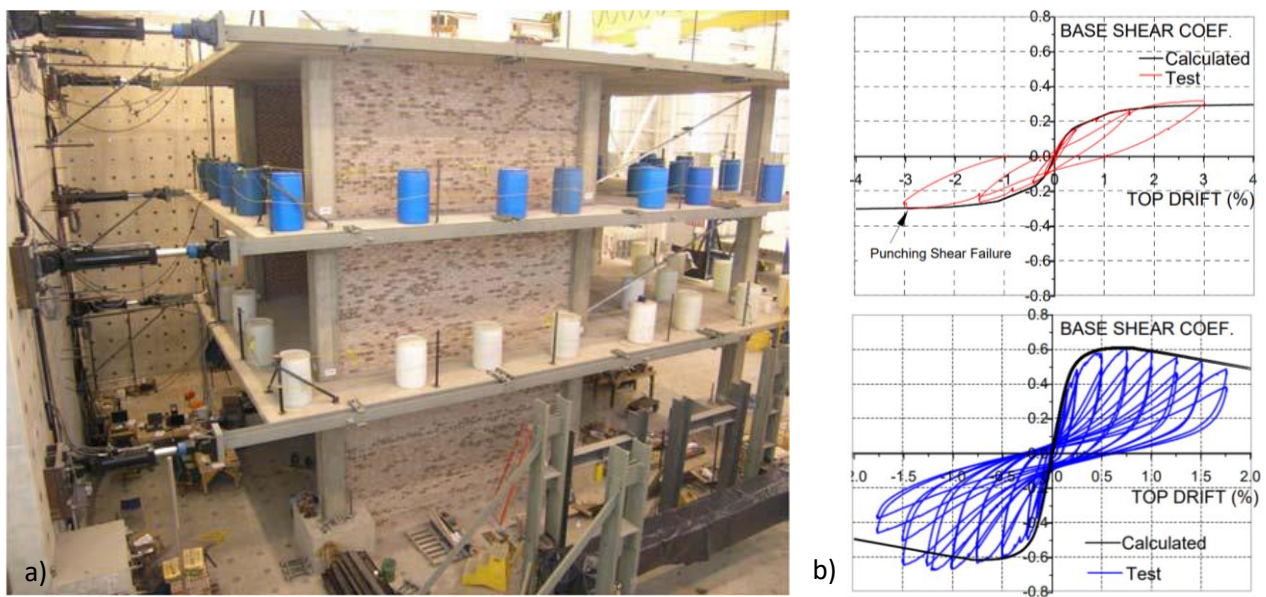

Figure 11 – a) Flat-slab structure strengthened with masonry infill walls; b) capacity curves resulting from the experimentations with partially (above) and fully (below) infilled frames – Source: [38]

FRP retrofit systems are usually composed of surface-bonded sheets applied on the masonry infill walls and anchored on the reinforced concrete frame with an epoxy resin. Several studies have shown that this measure can increase the infill strength and delay cracking [39].

Yuksel et al. tested six different RC frames with low concrete compressive strength under constant vertical load and reversed lateral loads [40, 41]. Force-displacement envelopes are shown in figure 12 using the following notation: the first letter is for bare or infilled (B, I) specimens, the second for continuous or divided vertical reinforcement at the base of the columns (C, L) and the third for strengthening of the infills and confinement of the lap-splice area with carbon-FRP sheets (C). Infilled frames showed higher strength and stiffness compared to their bare frames. Strengthening the infills with FRP provided a further increase of strength and not relevant variation in stiffness. The addition of FRP strips modified the response of infills in the sense that crushing at the corners was prevented, diagonal cracking was distributed throughout the infill and despite the severe damage, collapse was avoided. It should be noted that due to the higher concrete compressive strength, the frame with divided vertical reinforcement shows slightly bigger strength and stiffness compared to the one with continuous vertical reinforcement [27].

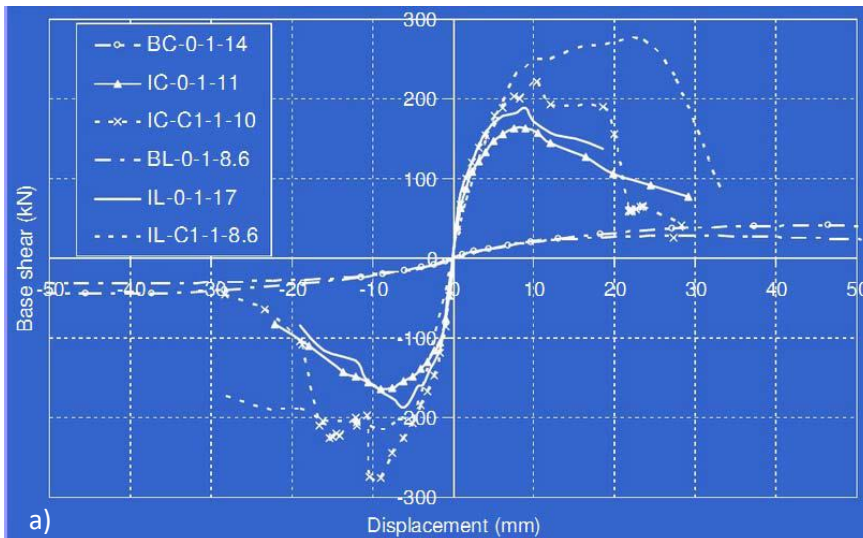

Figure 12 – a) Base shear versus displacement envelopes for bare and infilled frames; b) photos of the damage on infills strengthened with FRP – Source: [41]

Finally, the last strengthening-possibility with infills provides the use of precast concrete panels. The use of prefabricated elements helps to avoid the practical implications of cast-in-place walls, such as interference with occupants and functions of the building, long construction time and manpower, guaranteeing rapid construction procedure and high quality control [42]. More recently Kurt E. G. performed pseudo-dynamic tests on 1/2-scaled three-bay and two-storey lightly reinforced concrete frames, strengthened with RC infills and FRP strips or precast concrete panels applied on one face of the masonry infills [43]. The proposed retrofit solution was efficient in reducing significantly the displacement demands, drift ratios at both stories and curvature ductility at the base of the columns at the first storey. Reduction of the curvature ductility was more prominent for the column at the corners of the frames. The application of precast panels resulted in a reduced displacement ductility demand. Baran et al. studied the use of high-strength precast concrete panels for the strengthening of existing brick infills [44]. Eleven one-bay one-storey 1/3-scaled frames were tested under cyclic loading (Figure 13). The specimens were strengthened by using four types of precast concrete panels with different geometry and connection details. The seismic performance of the strengthened frames with respect to the as-built infilled frame proved to be so successful in increasing the strength, that shear keys and welded connections came to be redundant.

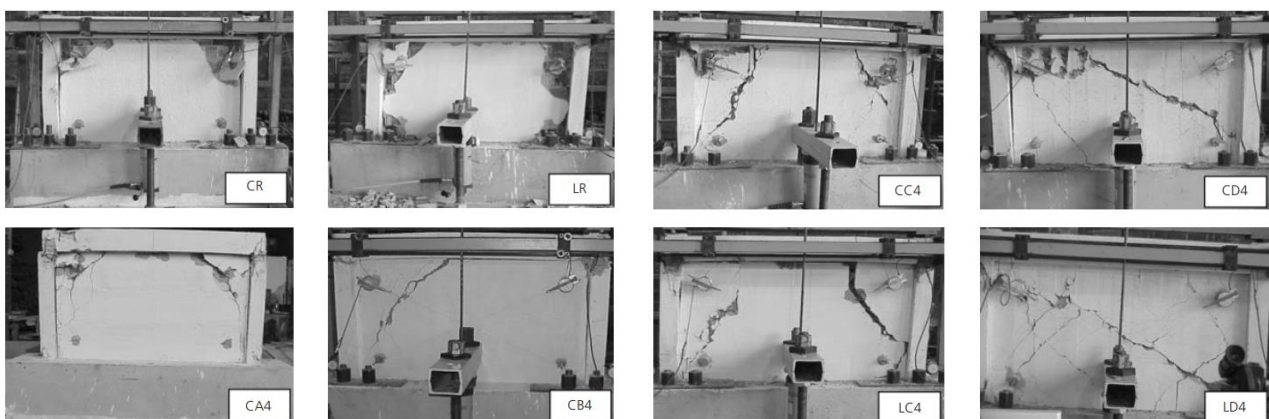

Figure 13 – Part of the specimens, of prefabricated concrete infills, tested by Baran et al. – Source: [44]

Another common practice is the addition of RC shear walls. This technique offers many advantages as the reduction of storey drifts, prevention of storey mechanisms and eventually a reduction of irregularities, along the height and in plan [45]. The new walls are specifically designed to carry the horizontal loads while the

existing members are expected to be secondary elements that sometimes might be strengthened. The new RC wall can be added to a frame around an existing column or directly connected to it, in the form of a buttress at the ends of the frame, in between existing RC spans or on the external part of the structure. In [27] a scheme is presented, showing the three solutions (Figure 14). The first option entails higher disturbance to the occupants and more intensive secondary interventions. The two others minimise disturbance to the expense of a need for outdoor space, which is not always usable.

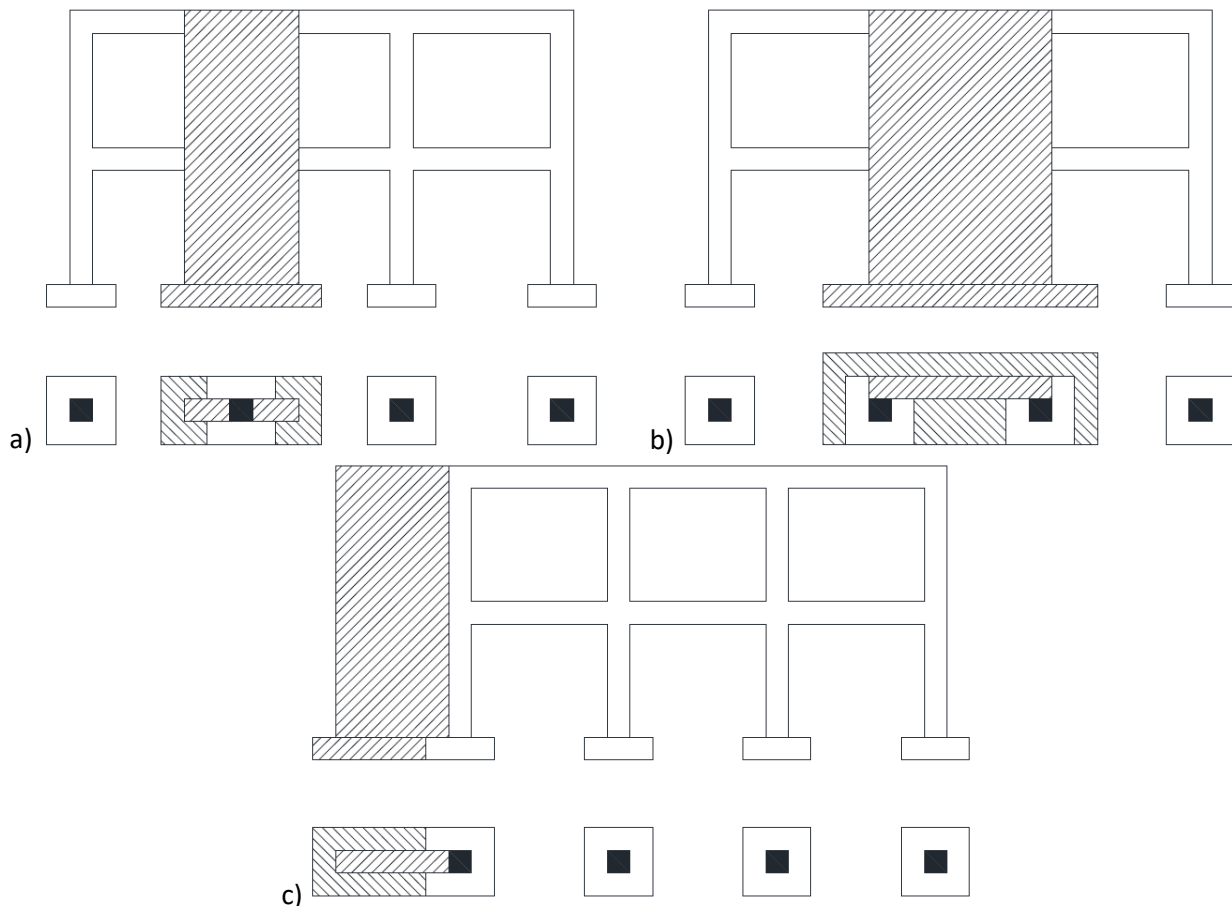

Figure 14 – View and cross-section above the foundation of RC frames strengthened with new RC walls placed: a) around a column; b) external to the frame; c) as buttress – Source: [27]

Regardless of the position of the new wall in relation to the existing frame, its foundation is a major problem, since a new element must be built, possibly incorporating existing ones. This is particularly challenging when the wall is built on the boundary between adjacent properties.

To minimise disturbance to occupants, new walls may be constructed in the form of buttresses. Such a scheme has been studied experimentally by Kaltakci et al. on two-storey two-bay frames [46]. Cyclic tests on scaled samples showed an increase in strength and stiffness. Both quantities were influenced by the amount of vertical reinforcement in the columns. The specimen with a higher ratio of longitudinal column reinforcement ($\rho_l = 0.024$) failed at a higher drift (2%) than the specimen with small ratio ($\rho_l = 0.013 - 1.5\%$). The sample with more reinforcement also showed a greater increase in lateral strength. Horizontal cracks were observed on the new walls at the cross-section where the starter bars from the foundation were terminated. External walls were also added to a two-storey three-bay RC frame that was tested under cyclic loading by Kaplan et al. [47]. The new walls were built on the outer side of frames across the central span and together with the existing columns have a C-section, see Figure 14b [27]. The strengthened frame had more than three times the strength of its as-built counterpart and seven times the stiffness. The failure of the wall was caused by shear sliding at the base after the longitudinal reinforcement in the wall broke.

Walls that can oscillate (rocking motion) on the other hand, either at the interface between the wall and the foundation or between the foundation and the ground, have been extensively studied for new structures as well as for the retrofit of existing ones [27]. In contrast to the traditional approach where hysteretic energy is dissipated by plastic hinges on the structure, it is assumed that rocking walls do not suffer any damage, maintaining their strength and stiffness while ensuring, through a re-centring behaviour, no residual deformations due to the vertical post-tensioned tendons. A three-storey building with post-tensioned walls and frames suffered no structural damage during the 2011 Christchurch earthquake [48]. When referring to hybrid walls, energy dissipation can be provided by additional devices. They present a flag-type force-displacement curve. A rocking wall is schematically shown in Figure 15, where, in addition to the aforementioned components, shear keys used to prevent horizontal sliding and ‘armours’ that protect the concrete at the corners from crushing, are also shown [27].

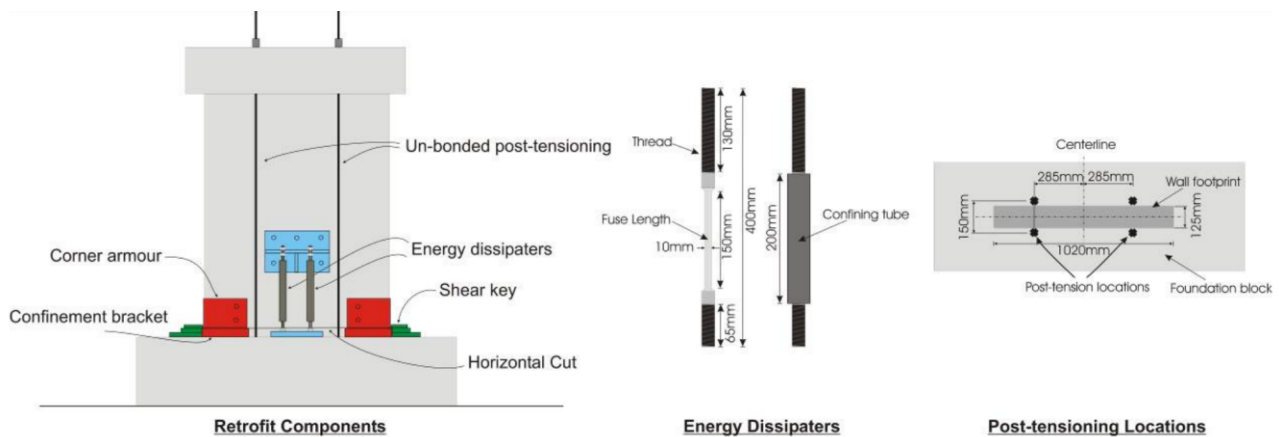

Figure 15 – Components of RC rocking walls – Source: [49]

In addition, RC infills that are connected on all four sides to existing beams and columns can be classified at the same way as new shear walls. They behave almost as well as monolithic cast walls. Infills that are connected only to the beams or are made of precast panels, without connection across their vertical interface, clearly provide less improvement in strength and stiffness.

Finally, it is important to introduce steel bracings. The strengthening of RC frames with the use of additional steel bracing has been a widespread method and subject of several investigations over the past decades. A brief introduction is presented below to complete the general overview. In Section 4, the state of the art will be extended, as it represents the basis for the development of an external steel strengthening structure.

Steel bracings can be designed to provide stiffness, strength, ductility, energy dissipation, or any combination of these. Performance objectives ranging from displacement control to collapse prevention can be achieved. The aim is to design systems that are strong enough to resist seismic forces and, at the same time, require the least amount of interventions on the existing structural elements. In general, these systems can be installed quickly, and minimise disruption to occupants and services. Advantages and disadvantages of this retrofit scheme are listed below [27, 50, 51] (Table 3).

Table 3 – Advantages and disadvantages on using steel braces strengthening systems – Source: [27]

Advantages	Disadvantages
<ul style="list-style-type: none"> ▪ increase of the lateral resistance; ▪ strength and stiffness levels adaptable with the choice on number and size of elements; ▪ if adequately detailed to avoid brittle failures, satisfactory ductility and hysteretic behaviour can be obtained; ▪ the new system can be designed to carry the entire lateral loads, which is particularly advantageous if the frame has an unfavourable failure mechanism; ▪ adequate control over the flow of force and minimum local force concentration; ▪ minimal added weight to the structure; ▪ ability to organize openings; ▪ minimal disruption to the function of the buildings and its occupants (in case of external bracing) and minimal loss of living spaces; ▪ easy of construction. 	<ul style="list-style-type: none"> ▪ difficulty to control the interaction between new steel and existing concrete systems; ▪ difficulty in the detail of the connection with the existing concrete, often of poor quality; ▪ difficult fixations in relation to the presence of reinforcement inside the existing concrete members; ▪ not efficient for stiffening concrete rigid structures; ▪ sensitive to detailing of braces and connections against local buckling and post-buckling fracture; ▪ difficulty in achieving high-quality full-penetration welds on the construction site and installing epoxy-grouted fasteners.

Usually, steel bracings are inserted directly between the concrete frame or fixed to it from the outside through a steel frame. They can be divided into four main types:

- concentric bracings (diagonal, X and V). This structural scheme provides members subjected to axial loads (Figures 16a, 16b);
- eccentric bracings provide diagonal element subjected to axial loads like the first category, but the eccentricity of the layout is such that energy can be dissipated in specific parts of the structural scheme, by means of cyclic bending or cyclic shear (Figure 16c);
- buckling constrained bracings provide specific members where the global buckling is inhibited by appropriate systems.

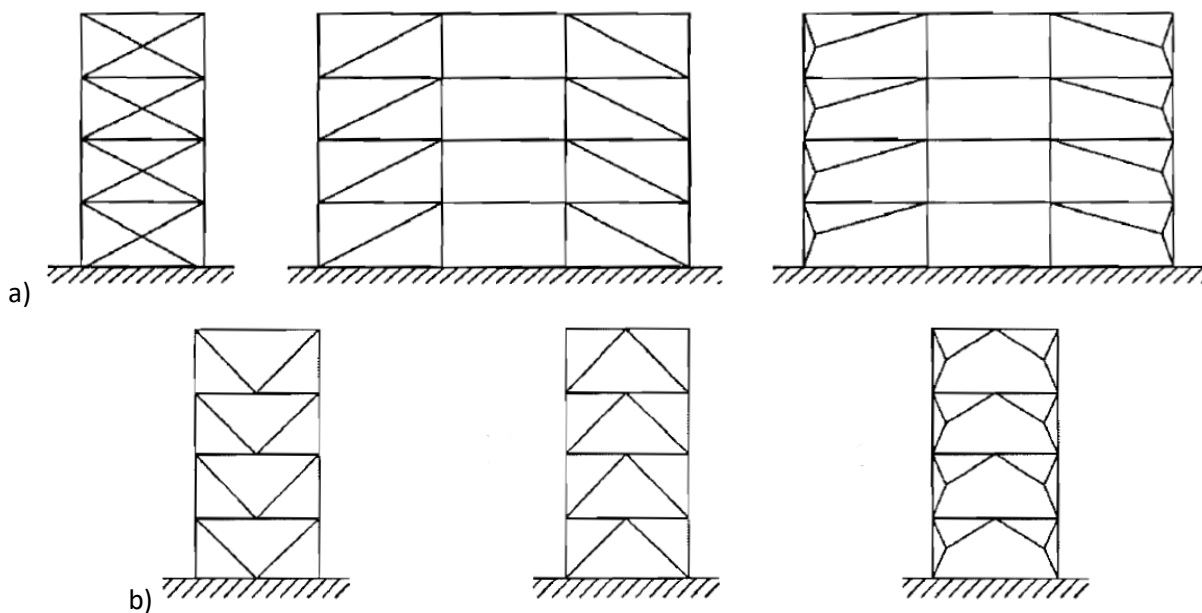

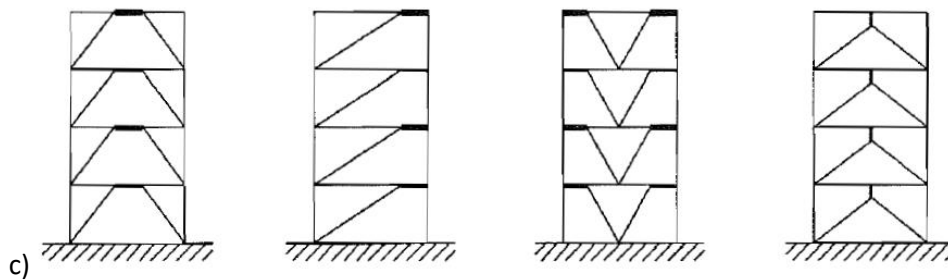

16 – Different types of bracing systems: a) concentric diagonal bracings with dissipative zones in tension diagonals only; b) concentric V-bracings with dissipative zones in tension and compression diagonals; c) eccentric bracings with dissipative zones in bending or shear links – Source: [12]

Concentric bracing systems are the most widely used for the retrofit of RC frames. They contribute to the lateral load resistance of the structure through the horizontal projection of the axial force (mainly tension), developed in their inclined members [27]. Numerous experiments have observed that the expected result depends on the characteristics of the existing RC structure and the design method used. In [52] the results indicate that when concentric bracings are applied on ductile frames (see Figure 17a) there is a considerable increase in strength (up to 3.5 times) and stiffness (up to 2.5 times) at the expense of ductility and the ratio F_e/F_y (i.e. the ratio of elastic force at ultimate displacement to yield strength), which were reduced up to two times. On the contrary, in [53] the steel strengthening system is applied to non-ductile RC frame structures (Figure 17b) and the results show, together with the increase of stiffness and shear resistance (on average 2.5 times), a reduction of maximum storey drifts by 20%, and also a higher energy dissipation.

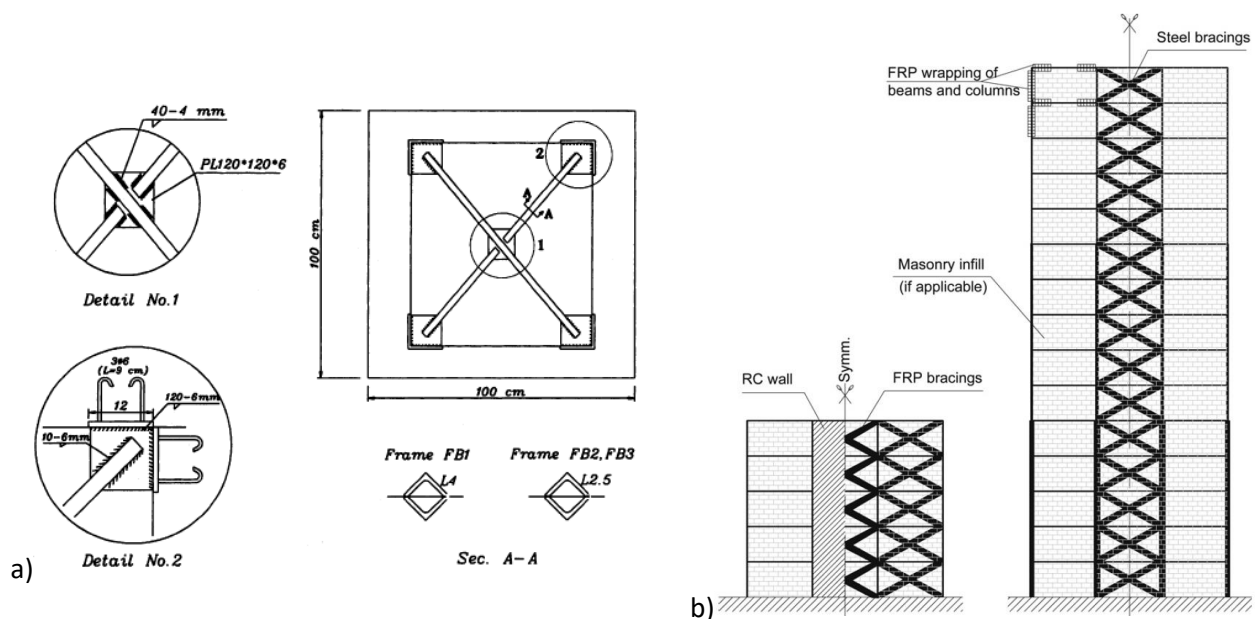

Figure 17 – a) Concentric X-bracing provided by Maheri et al.; b) bracing scheme proposed by El-Sokkary and Galan for RC existing buildings – Source: [52, 53]

Görgülü et al. [54] experimentally investigated the improvement of seismic performance of RC structures with external steel shear walls consisting of bolted horizontal, vertical and diagonal elements. These external steel shear walls were able to improve the lateral load bearing capacity and stiffness of the existing reference model. They also recorded effective load transfer through the anchorages. Below, in Figure 18a is an example of external steel shear walls. In relation to the design method, reference is made to Liu et al. [55] who confirmed the reliability of RC frames with steel bracing by performing the seismic design with displacement-based methods while the sections were sized according to capacity design principles. Their result showed the

effectiveness of the steel braced retrofit technique in terms of strength, ductility, and energy dissipation capacity (Figure 18b).



Figure 18 – a) Buttress type external steel wall; b) RC frame strengthened with steel braces – Source: [27, 34]

Eccentric bracing is an effective technique to improve the seismic resistance of existing frame buildings because, in addition to strength and stiffness, it can provide ductility. Forces are transferred from the diagonal members to the eccentric steel part, called steel link. These concentrated stresses result in hysteretic dissipation in the form of bending and shear forces. In fact, the link is designed to yield and dissipate energy, while preventing the bracing members from buckling. Different designs can be provided: K, Y, and inverted Y configurations. As reported in [27] a relevant advantage of eccentric bracings is the possibility to select the dimensions of the links and braces almost independently of each other, thus allowing the stiffness and strength to be modulated as required. While the cross-section of the link determines the shear strength of the storey, the length of the link and the cross-section of the bracings quantify the stiffness of the bracing system. However, the use of eccentric bracing still needs further investigation when provided in hybrid solutions with RC structures.

Ghobarah and Abou Elfath performed time-history and pushover analyses to evaluate and compare the strengthening of an existing three-storey, five-bay RC building with concentric and eccentric bracings. Stated a comparable increase in load capacity, while the stiffness of the concentric braced solution was higher than that of the eccentric braced one, a comparison of storey drifts at the same PGA level shows a better result for the eccentric braced solution, with a reduction in displacement and damage index [56]. Another comparison was made by Durucan and Dicleli, between eccentric inverted Y bracings and infill panels. It was shown that the braced solution had a more stable hysteretic behaviour, a higher energy dissipation capacity and suffered significantly less damage than the retrofitted solution with infill panels. For horizontal loads corresponding to the near collapse performance level, the average storey drifts after the application of bracing were five times lower than in the one with conventional strengthening [57].

Although conventional concentric bracing systems are efficient, they suffer buckling due to their high slenderness ratio. This has led to the development of buckling-restrained (BRBs) or unbonded braces, in which a steel core element (cross-shape or flat bar) is enclosed in a steel tube (also called buckling-restraining element) and is confined by a decoupling material like cement mortar, rubber, silicon, vinyl, etc. The core element is designed to resist axial tension or compression force without local or global flexural buckling [27]. It has been experimentally proved [58, 59] that this type of bracing, when applied on existing RC frames (Figure 19), can have a good response in both tension and compression, providing increased load-bearing capacity, strength and ductility.

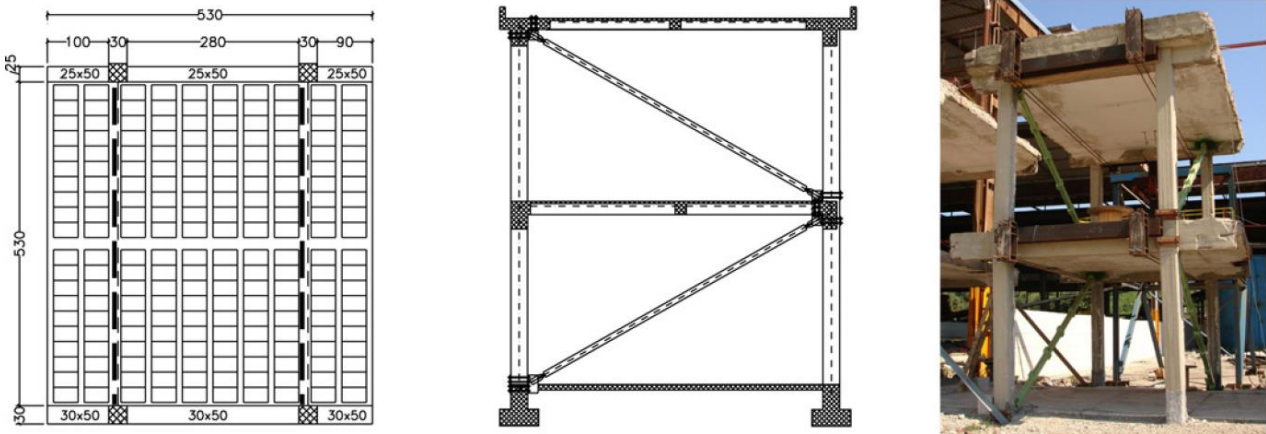

Figure 19 – Geometry of existing RC frame and buckling-restrained braces – Source: [58]

2.4.3 Use of isolation or dissipation devices

As an alternative to the above-mentioned methods based on strengthening, it is important to mention (to complete the framework) the use of technologies that aim to reduce the seismic forces acting on the building, preserving the contents and the functionality during and after the earthquake. These technologies include seismic isolation and passive dissipation of seismic energy, have already been used in 2012, in more than 10'000 structures worldwide, and in various types of buildings and infrastructures (bridges, viaducts, industrial plants, etc.) [60]. These solutions aim at reducing the seismic demand, either by directly inserting isolation devices at the base of the building to lengthen the vibration period, or indirectly by inserting dissipative elements (dampers) to increase the overall damping of the structure.

Pursuing the strategy of dissipating energy consists in providing, in specific points of the structural scheme, devices (dampers) capable to concentrate and dissipate a considerable amount of energy coming from the earthquake. This means transforming this energy into heat, thanks to the elastic properties of polymeric materials or viscous special oils, or super-elastic shape memory alloys. Without the presence of these devices, the same amount of energy would be consumed through damage to structural members. In practice, the additional dissipated energy produces a substantial reduction in the horizontal loads applied to the rest of the structure and, therefore, the deformations on existing structures are reduced. Many devices increase the damping without increasing the stiffness of the building. This fact is graphically translated into a reduction of the response spectrum (Figure 20a). On the other hand, when devices increase damping and stiffness, then there is also a reduction in the natural period (Figure 20b).

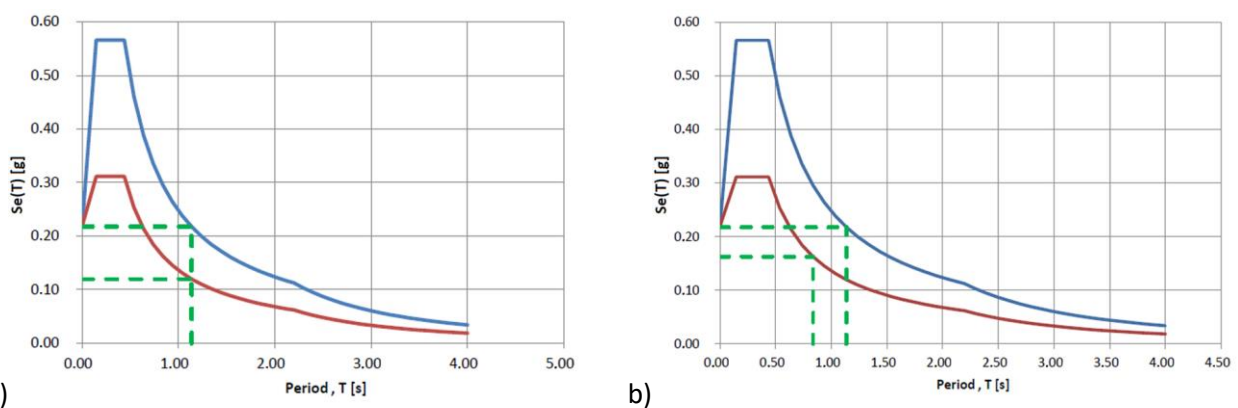

Figure 20 – Response spectrum functions showing the variation of the reference pseudo-acceleration after the application of a dissipation device. a) The intervention does not provide additional stiffness; b) the additional stiffness connected to the intervention implies a reduction in the fundamental vibration period

Various types of energy dissipators have been developed and presented in the literature, such as metallic components, mild-steel elements, viscous and elastic-plastic type, as well as with impeded instability, viscoelastic, friction, or electro-inductive. In particular, the elastic-plastic dampers are based on the ability of particular metals or other materials to withstand numerous cycles of high plastic deformations, while the viscous dampers are based on the energy dissipation resulting from the passage of particularly viscous fluids (e.g., silicone) through narrow orifices in parts of a cylinder-piston system.

When applied in the retrofit of existing RC buildings, these elements must be placed in specific locations where they can absorb the energy that transforms displacement into heat. Therefore, it is necessary to ensure a precise knowledge of the building in all its components and materials, to determine its behaviour and predict its displacements. The displacements must be sufficient to activate the devices and allow them to consume this energy. Depending on the type of device and the morphology and behaviour of the existing structure, the appropriate structural scheme can be developed.

Özkaynak H. studied the effects of applying an additional metal energy dissipating element (a mild steel cushion) in a bracing system installed in a RC frame (Figure 21). The results showed that most of the earthquake input energy was dissipated through the device and consequently that the plastic energy demand of the structural elements decreased by almost 50% at both immediate occupancy and life-safety performance levels. In this case, according to the force-displacement relationship, not only the dissipation increased, but also stiffness and strength followed the same positive result [61].

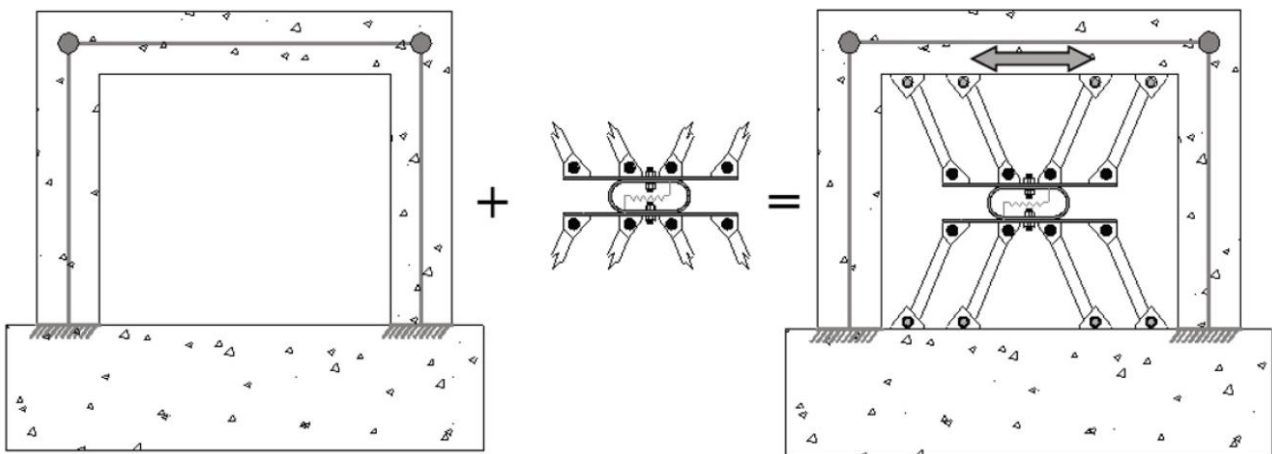

Figure 21 – Implementation of the cushion in a RC frame – Source: [61]

A disadvantage of using a damping system in a diagonal or chevron configuration may be the increase of axial forces in the columns, which may lead to premature local failures. Furthermore, the indirect costs related to the interruption of the use of the building during the execution of the retrofit can be very challenging. In order to avoid the above-mentioned issues, recent studies and best practices placed dissipative bracings and associated foundations outside the building in different configurations [62]. In contrast to the more consolidated solutions of dissipative bracing between existing spans, dissipators may be placed horizontally at floor level, between the RC frame and an external rigid structure (Figure 22a). Alternatively, placed in a shear-deformable bracing structure (Figure 22b), or more recently some applications have seen the devices placed under rigid steel towers (Figure 22c, d, e). The latter configuration exploits the rocking motion of a rigid truss tower, hinged at the foundation level, and connected to the existing building at the floor levels. The dampers are located in vertical position at the tower base and are activated by displacements induced by the rotation of the tower base [63]. The application of this system demonstrates a high protection efficiency to the near collapse performance level, reducing horizontal displacements and accelerations. As a consequence of the increased damping of the system, the shear forces resisted by the frame also appear to be considerably reduced after the retrofit.

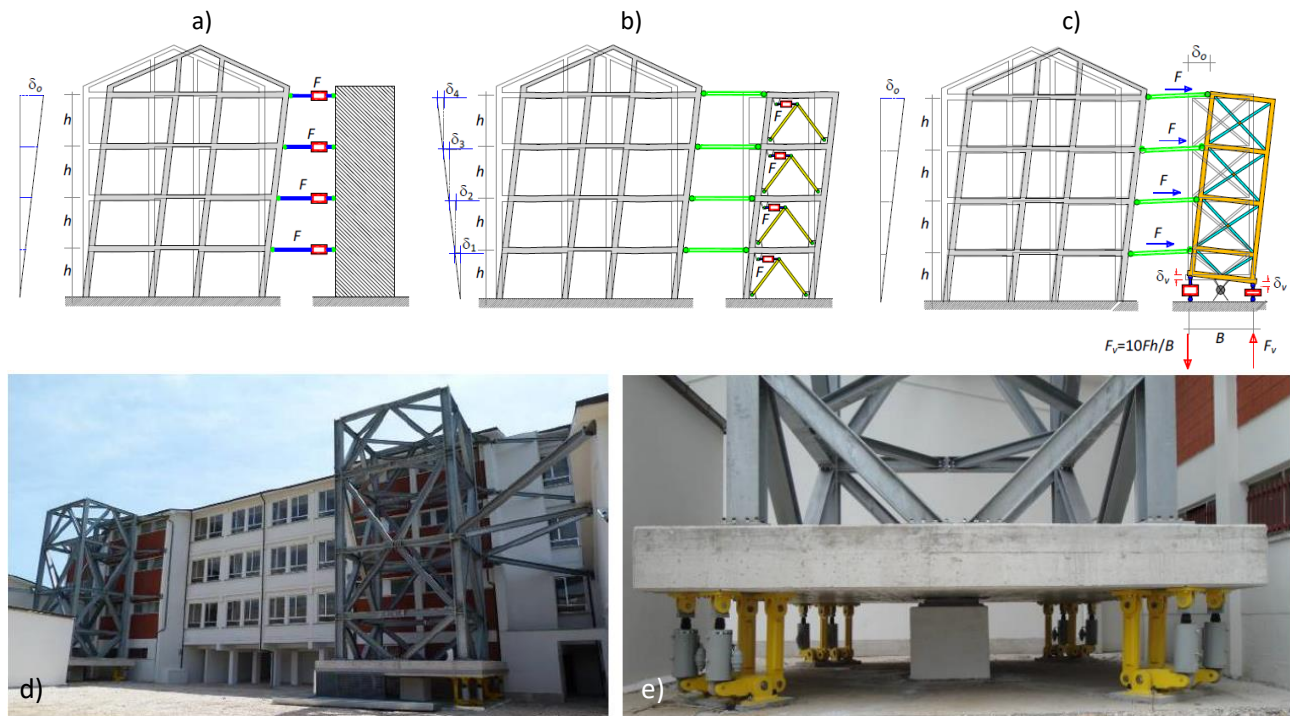

Figure 22 – Seismic-retrofit systems made by external structures. a) The dissipative devices are activated by absolute floor displacements; b) by the inter-storey drifts; c) through rotation of the rigid truss towers; d) overview of the seismic retrofit of the school building in Avezzano; e) photo of the dissipation system under the base of the tower – Source: [63]

The application of isolators, on the other hand, involves decoupling the movement of the ground from that of the building. Initially used as protection for infrastructures such as bridges and viaducts, they were later used for strategic buildings, civil structures, and monumental buildings in historic centres. These devices allow the building to swing smoothly, independently of the ground. The isolators must be positioned at the base of the building, on top of a foundation plate or on the ground floor above very rigid columns, so that the motion of the ground is transmitted uniformly to all the damping elements and filtered through them to the building. It is necessary that the structure above the isolators is also sufficiently rigid to move horizontally, without increasing the acceleration as the height increases.

In the case of existing buildings, the devices can be inserted either by cutting the columns at ground level, or by means of a sub-foundation (a preferable solution for interventions on historic architecture). It is important, for the mechanism to work, to provide a total disconnection of the outline of the building from the surrounding ground and from adjacent buildings, and therefore to provide wide range joints and flexible connections for all the technical systems.



Figure 23 – Examples of isolator applications. A) One of the 12 isolators applied in the new school Francesco Jovine in San Giuliano di Puglia; b) some of the 61 high damping rubber bearing (HDRB) isolators installed at the base on the above-mentioned school; c) some of the 16 HDRB installed on an isolated floor of a building in Foligno (Perugia) – Source: [60]

In general, dissipative systems are less effective than isolation systems because they allow seismic energy to enter the structure unaltered and because, in order to activate and perform, they need the structure to deform and therefore cannot reduce the relative displacements to the same extent of isolators. Finally, they often make it necessary to install numerous unesthetic elements, such as the bracings (to rigidly transfer the movement of each floor to the height of one below or above) and also the dissipators themselves. However, this technique is particularly useful when seismic isolation is not applicable, i.e. either because the structure considered is too flexible, or because the ground on which it lies is too soft, or because the building does not have (and does not allow the creation of) structural joints, gaps, large enough, with respect to adjacent buildings, to allow the necessary rigid displacements [64].

It must be stressed that, with seismic isolation not only the structure is protected, but also the non-structural components (infill walls, partitions, etc.) and the mechanical systems inside the building remain undamaged. In addition, since the vibrations of the isolated structure are slow (high natural period), the condition of panic induced by the earthquake (which can be very dangerous in buildings with high population density or in strategic buildings, such as schools and hospitals, where activities can proceed without interruption) is eliminated.

2.4.4 Additional evaluation criteria for strengthening solutions

After the assessment of identified deficiencies on an existing building, common seismic problems can be located and effectively mitigated with specific techniques, strictly targeting the retrofit activity. Whenever possible, the designer should proceed with the selection of the technique that allows several deficiencies to be addressed at once. Adding strength or stiffness is very common, and few new elements may solve problems of strength, inter-storey drifts, and eventual irregularities. As mentioned before, new lateral force-resisting elements imply the consideration of several related issues, such as compatibility of deformation with existing structures, efficiency of load-transfer between structures, mass variations, new foundation system etc. However, several variables are involved in the selection process of retrofit strategies. Along with technical criteria, it is important to include practical, social, and economic aspects that may be decisive in the selection and feasibility of a strengthening system. In fact, the chosen retrofit solution is almost always dictated by user-oriented issues rather than the mere fulfilment of technical requirements. Building owners or users are mostly interested in the following issues [9, 11, 27, 65]:

- cost;
- seismic performance;
- disruption of use;
- availability of materials, technology, and workmanship;
- constructability;
- long-term functionality of building;
- reversibility;
- aesthetics and consideration of historic preservation.

All these characteristics are always considered during the evaluation and selection of the interventions and a combination of weighting factors will determine the strategy to be adopted.

In each country, legislations give specific indications on seismic strengthening and design standards with consequent seismic performance requirements. Based on this, the performance value sought in the structures becomes a fundamental part to evaluate the benefit-cost ratio underlying the development of the whole project. It becomes particularly important when the intended use falls on strategic buildings such as schools and hospitals, where the retrofit method must provide for limited damage or continues occupancy.

Construction work causes noise, vibration, dust, and other types of disturbance, and when the building is partially or fully occupied, this parameter commonly becomes dominant and may control the design. To minimize disruption, schemes that place strengthening elements outside the building envelope are often explored. In this way, concrete shear walls, pier-spandrel frames, and steel braced frames placed adjacent to or within the plane of the exterior walls have been used. The shear connection of the diaphragms

to these new elements must be carefully considered. External elements that can provide new strength and stiffness perpendicular to the external wall have also been used. The consequent structural system must run around the building to connect the new elements to the floor diaphragms. The installation of this additional system may disrupt the internal structures and finishes sufficiently that the building occupants may still need to be evacuated during the work. Although, if carefully designed, exterior solutions can be installed with continuous occupancy of the building by coordinating construction processes in relation to the internal activity and managing the site and access.

The feasibility of one intervention rather than another may also depend on the local availability of materials, technology, or workmanship. When these elements are not available locally, they can lead to a significant increase in construction costs.

The design engineer must consider practical issues when conceiving a rehabilitation scheme; the reality of field conditions may make a scheme physically or economically unfeasible. The possibility of obtaining adequate access to the available space around the building, as well as the correlation with the existing foundations, the impact on the mechanical, electrical, and plumbing systems are all factors that must be considered in the development of the scheme. For instance, all piping passing through the level where the isolation devices are located must be designed to accommodate large displacements.

The insertion of new elements into a building will certainly change the functional space, it will have to be adapted around them. In addition, the flexibility of future space redesign will always be compromised. This point is often less important than the others and is therefore sacrificed to fulfil other main objectives.

In historic buildings, considerations for the preservation of portions of the building usually control the design. Structural performance objectives are also controlled by the limitations imposed by restoration. In non-historic buildings, aesthetics may be commonly cited as a criterion. However, in this case, minimising costs, and disruption to tenants, and maximising structural improvement may very often be relegated to the background. For certain buildings, reversibility is also considered as an important requirement.

Depending on the legal provisions that apply in different countries regarding the responsibility and the liability of designers and contractors, it is worth mentioning the question of the share of responsibility/liability for losses in future earthquakes, between the designer or contractor of the existing building and those employed by the owner for the retrofitting. The level of knowledge of an existing building is variable, depending on the extent of the investigation, and even with the most accurate assessment, it is not possible to determine all the details of an existing building. The quality of the building's materials and/or the quantity or details of its reinforcement may remain undetected, especially since the cost and time required for a complete survey and documentation of the as-built structure may be prohibitive. Consequently, the retrofit project cannot completely reverse an already compromised structural configuration or change the quality of existing materials or details. Therefore, in order to reduce their liability, designers tend to provide extensive survey which increases the final cost of the renovation. A fair and efficient regulatory system for the responsibility of the parties involved is therefore a prerequisite for a successful implementation of a seismic rehabilitation program [9].

The cost is usually the first driving factor to those who want to realize a building retrofit. Construction cost is a fundamental parameter that should be entirely examined. In fact, non-structural interventions are often likewise important as structural ones. They can be defined as minor works like removal and reconstruction of finishes, temporary measures during construction, upgrading of electrical, mechanical, or fire-suppression systems and provision of handicapped access, or they are related to the value of the contents of the building and then involving a cost related to the disruption of use of the building (e.g., temporary housing of occupants, business interruption and relocation of services). That is why, improving the seismic safety of a building may result in an improvement in the quality of a facility that leads to higher rental prices and lower insurance premium, which could (partially) compensate the retrofit costs.

The cost determines at first the choice on the adopted strategy and when compared to the damage entity and the cost of replacement of the building may eventually lead to the more drastic choice of demolition and reconstruction. In Figure 24 are shown percentages representing the ratio between the cost of repair/retrofitting to cost of replacement for various levels of damage, for a sample of buildings in Turkey [66].

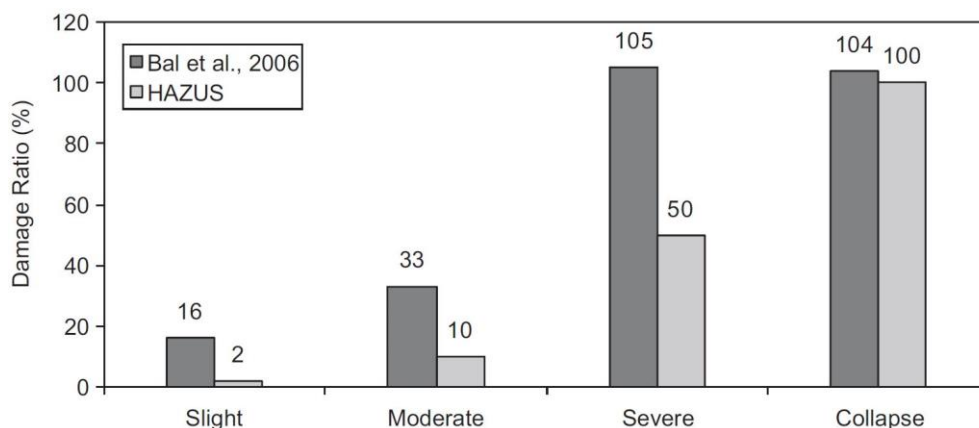

Figure 24 – Comparison of the damage ratios suggested in [66] with those from HAZUS [67]; the percentage ratios suggested in [66] for severe and collapse damage levels reach over 100% (corresponding to replacement cost) because of regulatory requirements

As presented in the next chapter, it is therefore crucial to enhance the value of building renovation (energy and structural) by combining other benefits in order to reduce/amortise renovation costs and promote the development of safer and more sustainable cities with consequent benefits for owners, residents and the environment. Multiple retrofit actions can be linked to the same intervention. A summary of common structural retrofitting practices, available in the current scenario and reporting the possibility of further retrofitting action (mostly related to energy and technical systems) is shown in Table 4.

Table 4 – Summary of the effects of retrofit strategies; development from input contained in [9, 51]

Techniques	Local (L) and global (G) effects	Relative costs (C), disruption (D) and technological level (T)	Design considerations	Possible multiple retrofit
Injection Resins	L) Renewal of strength and stiffness G) None	C) Low-to-medium D) Low T) Medium	Renewal approach, all the voids of cracked and damaged concrete elements must be filled by the adhesive material; it does not confer any seismic improvement	No
Reinforced concrete jackets	L) Improvement of stiffness, strength and eventually of ductility G) Change of the seismic response; if applied to columns, it forces the yielding on beams (strong-column weak-beam mechanism)	C) Low, by elements D) Medium-to-high T) Low, unless it provides an extensive use of welding	It may solve the “soft storey” problem and lack of performance in specific elements; extension of jacketing to upper levels or to foundations may be necessary to avoid stiffness discontinuity; it requires the partial demolition of the building to isolate the structural elements with consequent high disruption	No
Steel jackets	L) Improvement of ductility and shear strength; it increases the stiffness when there is a strong composite action G) Increased global deformation capacity	C) Medium D) Low T) Medium	Effective where the principal problem is low transversal reinforcement; generally fast implementation, the gap between steel jacket and existing member must be filled by grouts	No
Partial bonded FRP strengthening	L) Remarkable increase of ductility but limited effects on strength and stiffness G) Increased global deformation capacity	C) High D) Low T) Medium-to-high	Effectiveness depends on the anchorage conditions with the existing members; FRP layers are considered as additional confinement and stress concentrations should be investigated; feasible solution when cost is not a controlling factor	No
Bonded FRP strengthening of beam-column joints	L) Eliminates shear failure in connections G) Low reduction of global displacements by reducing the connection deformation	C) High D) Low T) Medium-to-high	As above	No

Complete bonded FRP strengthening	L) Remarkable improvement in ductility and shear strength; Low increase of stiffness G) Unchanged stiffness distribution; remarkable effect in terms of strength distribution	C) High D) Low T) Medium-to-high	As above	No
Selective techniques	L) Measured and quantifiable improvement in one or a combination of parameters (stiffness, strength, or ductility) G) It adjusts the structural response to reach the performance objectives	C) Low, by element D) Medium T) Medium-to-high (more in analyses and know-how rather than materials)	It is the most appropriate approach if you have high analytical skills and experience from specialised engineers	No
Reinforced concrete walls	L) It could lead to increased internal forces in close structural elements G) Drastic reduction in deformation demands on all structural elements; It may solve the “soft story” problems	C) Medium D) High T) Low	The technique requires the partial demolition of the building to isolate the structural elements to be worked on; a drastic intervention in the foundation is necessary; feasible solution when disruption is not a controlling factor	No
Internal steel bracing	L) Protects brittle RC elements nearby, but may introduce large forces at connections G) Improvement of global ductility and dissipation capacity; it may solve the “soft story” problems	C) Medium-to-high D) Medium T) Medium	It needs attention in the design of the steel elements and connections to avoid local buckling and post-buckling failures	No
External steel bracing, in collaboration	L) It reduces the stresses on existing members but leads to internal local forces near the connection with the existing structure G) Drastic reduction in deformation demands on all structural elements; It may solve the “soft story” problems	C) Medium-to-high D) Low T) Medium	It needs attention in the design of the steel elements and of the connections with the existing structure; an intervention in the foundation is necessary; the positive contribution of the intervention is low if the existing structure is stiff	Yes
External steel frames, decoupling horizontal and vertical forces	L) It changes the behaviour of RC elements by insertion of Mesnager hinges (supporting only vertical loads) G) The entire seismic action is assigned to a new external steel structure	C) Medium-to-high D) High T) Medium	Very effective solution to the detriment of a large demolition work; an intervention in the foundation is necessary; the technique requires the demolition of the major part of the building to isolate the RC structural elements; a drastic intervention in the foundation is necessary; feasible solution when disruption is not a controlling factor	Yes
Insertion of infill panels	L) They generate remarkable internal stresses in the corners; it increases the storey stiffness reducing inter-storey drifts G) Increased weight, hence seismic loads; reduced period, hence increased accelerations; if the panels are monolithic, they can change the global response leading to a cantilever behaviour	C) Medium D) Medium-to-high (depending on external or internal applications) T) Low	Effective solution when the panels are applied on the outside and well secured to the structure; it is possible to use precast concrete modules instead of masonry panels.	Yes
Seismic dissipation devices	L) Protects brittle RC elements nearby, but may introduce large forces at connections G) Improvement of global ductility and dissipation capacity; it concentrates the	C) Medium-to-high D) Low-to-medium T) Medium	Attention must be paid in designing damping elements and their connections; they require non-linear dynamic analyses to determine the damping increase; the displacement of the existing structures must be enough to activate the dampers (relevant	No

	dissipation of energy into strategically placed elements		displacement capacity); the technique is not feasible for stiff buildings	
Seismic base isolation	L) The seismic forces on structural and non-structural members are reduced G) Elongation of the vibration period with consequent reduction of acceleration (inertia forces).	C) High D) Medium-to-high T) High	Requires specialized skills for the construction phase and the design; requires a dynamic characterization of soil and structure; a drastic intervention in the foundation is necessary with related invasiveness on inhabitants; there is no need for retrofitting the upper structure	No

Concluding, the objective to be undertaken when studying methods of seismic improvement is quite simple; however, achieving it is a matter of considerable complexity. The objective is to ensure that the design seismic demand is less than the capacity, resulting in a change in the design life of the structure. Ideally, decisions to intervene are made within a comprehensive cost-benefit framework and assessment of the effect of the various matters mentioned above, but it is also stressed that each structural intervention constitutes a specific case (different from the previous one) for which one or more of the options listed in Table 4 provide the best solution. “Therefore...”, citing [9] “...generalisation of rules for application in retrofit strengthening is neither possible nor advisable”.

3. Energetic, practical, and socio-economic aspects

3.1 Characterisation of the building stocks in seismic zones

The following section is intended to provide a statistical overview of the RC buildings which potentially represent the sample of potential impact for the research. In particular, these are RC residential buildings stocks, constructed extensively all-around Europe in the years following the Second World War and, as presented in the following paragraph, characterised by evident heat losses and energy-consumption issue. The analysis focuses on European countries where the seismic risk is more relevant, given the structural seismic nature of the topic.

3.1.1 Italy

A considerable part of the building's heritage was built in areas that only during time were declared seismic (e.g. many areas of Italy were included only in 2003 [68], following catastrophic events), built without the use of adequate seismic criteria. It is estimated that around 60% of the existing buildings have been constructed in these areas [6]. Most of these buildings have been built within the 1970s; therefore, already reaching and exceeding their conventional lifetime, with consequent problems of degradation and reduction of the mechanical properties of the structural elements.

In order to present a rough estimation of the number of buildings belonging to the investigated category, data from the 2011 ISTAT census [6] were examined. ISTAT identified:

- distribution of buildings by use (Table 5 and Figure 25);
- the number of residential buildings by period and construction type (Table 6 and Figure 26).

Table 5 – Number of buildings by type of use, data extrapolated on 04 September 2017 – Source: [6]

Year of census	2011										
Data typology	number of buildings (absolute values)										
Use status	used									not used	total
Type of use	residential	Productive	commercial	directional/ tertiary	tourist/ receptive	services	other type of use	all the items	not applicable	all the items	
Area											
Italy	12187698	287039	246082	60462	61426	178356	688182	13709245	743435	14452680	
North-West	2740018	89468	59937	14696	11622	45340	166886	3127967	136122	3264089	
North-East	2392384	71509	48477	12225	15151	35476	114876	2690098	95619	2785717	
Centre	2046272	48582	44736	10870	13106	31753	149594	2344913	95730	2440643	
South	3065295	48355	59849	13681	14856	41990	145516	3389542	248226	3637768	
Island	1943729	29125	33083	8990	6691	23797	111310	2156725	167738	2324463	

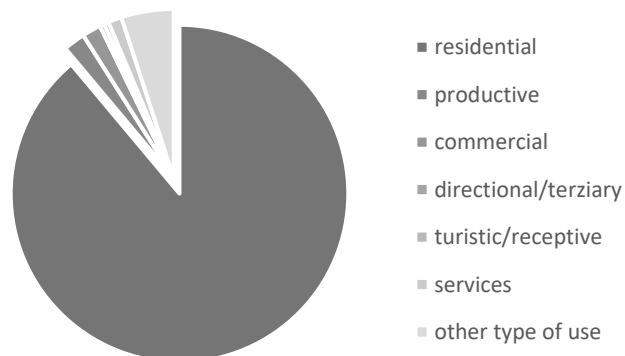

Figure 25 – Graph representing the percentage (89%) of the existing residential buildings in Italy – Source: [6]

As shown withing the total amount of buildings 89% have a residential destination. To reduce the sample, data regarding the construction type and the period were fundamental. Table 6 and the Figure 26 illustrate the distribution of residential buildings per year of construction and per type structural material.

Table 6 – Number of residential buildings by period and construction type, data extrapolated on 04 September 2017 – Source: [6]

Data typology	number of residential buildings (absolute values)									
N° of dwellings	total									
Year of census	2011									
Area	Italy									
Construction period	1918 and earlier	1919-1945	1946-1960	1961-1970	1971-1980	1981-1990	1991-2000	2001-2005	2006 and later	all the items
Type of material										
Bearing masonry	1725486	1149082	1212279	1087428	863668	467821	251721	125719	92773	6975977
Reinforced concrete	..	77122	303903	676242	907046	737632	455906	247516	189328	3594695
Others	107018	100803	184654	287163	346937	257314	163390	91869	77878	1617026
All the items	1832504	1327007	1700836	2050833	2117651	1462767	871017	465104	359979	12187698

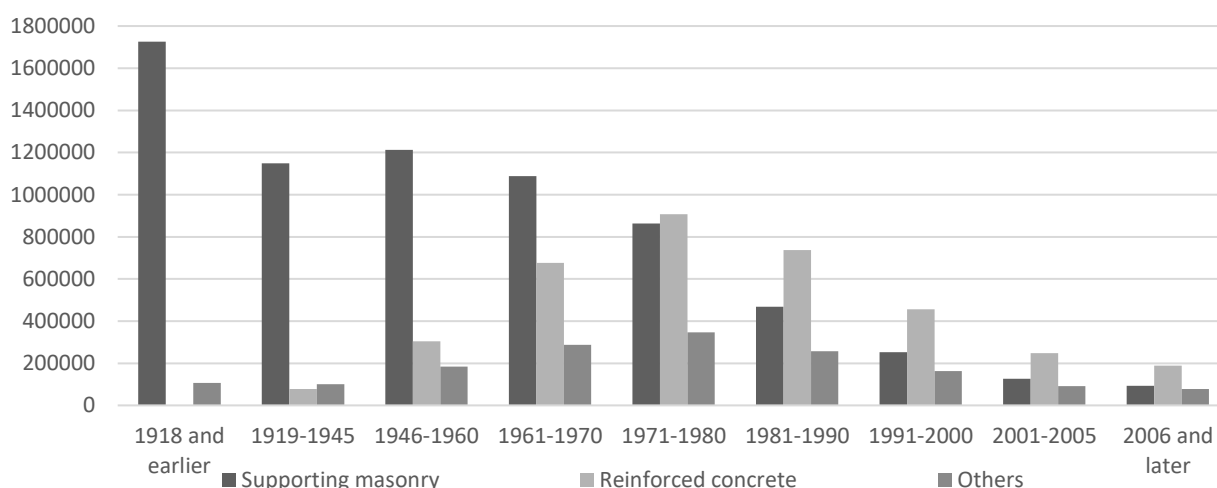

Figure 26 – Graph representing the number of residential buildings divided by year and construction type – Source: [6]

The increase of RC buildings after the 1940s is evident, reaching a peak before the 1980s, thus before the consolidation of seismic criteria in national standards, as well as before the division of the Italian territory into the current four seismic zones [68]. Therefore, the developing system has a potential impact on a total of 3'213'670 residential buildings constructed in RC, out of a total number of building stocks equal to 12'187'698; in other words, these energy and structural issues (considering only RC buildings) potentially affect 26% of all existing residential buildings in Italy, and 89% of the total number of RC residential buildings. In these figures, the distinction by building type (apartment blocks, terraced houses, etc.) is currently neglected, considering that the same problems may involve all types built with outdated requirements and standards.

3.1.2 Greece

Proceeding with the Greek scenario, data from the 2011 ELSTAT census [69-71] were examined:

- distribution of buildings by use (Table 7 and Figure 27);
- distribution of buildings by period (Table 8);
- distribution of buildings by construction type (Table 9 and Figure 28).

Table 7 – Number of buildings by type of use – Source: [69-71]

Data typology	number of buildings by type of use (absolute values)									
Year of census	2011									
Territory	Greece									
Type of use	Residential building	Church-monastery	Hotel	Factory-Laboratory	School building	Store-Office	Garage	Hospital, clinic, etc.	Other use	All the items
Exclusive-use buildings	2990324	47872	34736	30731	19474	153510	16952	1749	480500	3775848
Mixed-use buildings	255684	515	8780	3031	2379	52744	515	224	5917	329789
All the items	3246008	48387	43516	33762	21853	206254	17467	1973	486417	4105637

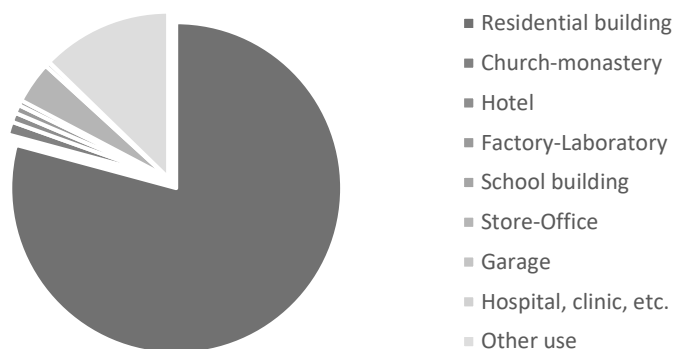

Figure 27 – Graph representing the percentage (79%) of the existing residential buildings in Greece – Source: [69-71]

Available census data indicate that the majority of exclusive-use buildings are single-storey buildings (55.0%). Furthermore, out of the total number of “residential dwellings” (2’990’324 buildings), the largest percentage (72.8% or 2’176’214 buildings) corresponds to single-family houses. Table 8 illustrates the number of total buildings by construction period.

Table 8 – Number of buildings by period of construction – Source: [69-71]

Data typology	number of buildings by period (absolute values)									
Year of census	2011									
Territory	Greece									
Construction period	Before 1970	1971-1980	1981-1985	1986-1990	1991-1995	1996-2000	2001-2005	2006 onwards	Under construction	All the items
Greece total	1691432	704340	402368	316799	259394	254797	237460	186861	52186	4105637
(%)	41.2%	17.2%	9.8%	7.7%	6.3%	6.2%	5.8%	4.6%	1.3%	100%

The majority of buildings (704’340 buildings) was constructed between 1971-1980 (17.2%). Furthermore, of the 41.2% of buildings constructed before 1970, 15.6%, equivalent to 639’475 buildings, were constructed between 1961 and 1970 while 14% (573’250 buildings) were constructed during 1946-1960.

Table 9 – Number of buildings by construction type – Source: [69-71]

Data typology	number of buildings by material (absolute values)						
Year of census	2011						
Territory	Greece						
Construction material	Concrete	Metal	Wood	Bricks-cement blocks	Stone	Other material	Total of buildings
Greece total	2368696	34868	19968	881593	723249	77263	4105637
(%)	57.7%	0.8%	0.5%	21.5%	17.6%	1.9%	100.0%

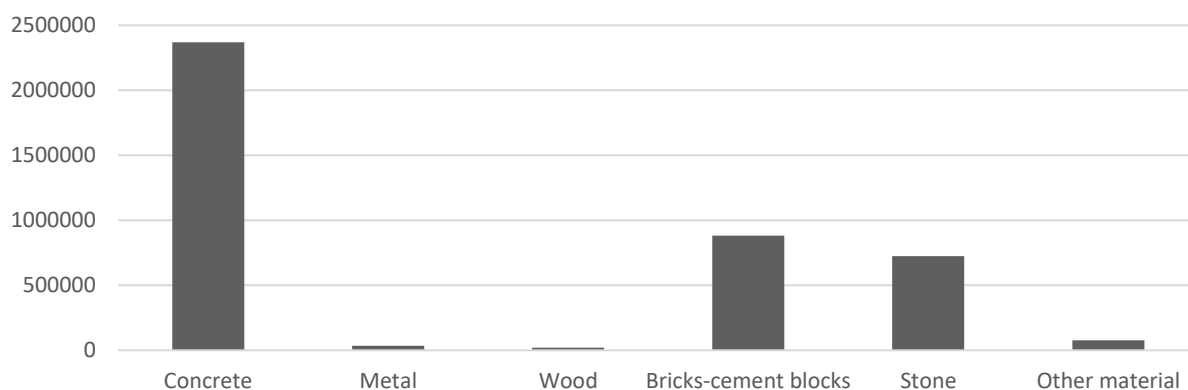

Figure 28 – Number of buildings by construction type – Source: [69-71]

From the correlation between the main construction material of the buildings and the number of their floors, the following information can be drawn: the largest proportion (63.4% - 1'501'753) of the buildings whose main construction material is concrete has at least one floor, while the largest proportion of buildings whose main construction material is steel, wood, bricks/cement blocks and stone correspond to single-storey buildings. In the absence of precise data relating the number of RC residential buildings with the construction time, the total amount of RC buildings is proposed as potential target for the research project. Thus, a total of 2'368'696 RC buildings, representing 57.7% of the existing Greek buildings.

3.1.3 Romania

For the Romanian case, data from 2002/2011 NIS census [72] were examined:

- distribution of residential buildings by typology (Table 10);
- distribution of dwellings by period and construction type (Table 11, Figures 29 and 30).

Table 10 – Number of buildings and dwellings – Source: [72]

Data typology	number of buildings and dwellings				
Year of census	2011				
Territory	Romania				
	Number of buildings		Number of dwellings		Number of households
	TOTAL	with dwellings	TOTAL	conventional dwellings	
Buildings	5117940	5103013	8458756	8450607	7086717

5'103'013 buildings with 8'450'607 conventional dwellings were registered by the October 2011 census in Romania. Apartment buildings count 71.7% of the urban stock. It is this part (about 2.9 million units in 76'000 buildings) which has the greatest need for urgent improvements.

Table 11 – Number of dwelling by period and type of construction – Source: [72]

Data typology	number of residential buildings (absolute values)											
N° of dwellings	total											
Year of census	2002											
Territory	Romania											
Construction period	1910 and earlier	1910-1929	1930-1944	1945-1960	1961-1970	1971-1980	1981-1989	1990-1994	1995-1999	2000 and later	all the items	
Total residential buildings	A	1652	2212	3456	9126	13774	37136	40174	20016	22128	11673	161347
	B	28470	33834	59008	126499	135758	146738	75587	58708	66626	33986	765214
	C	79629	87864	127530	318413	289456	184384	64162	42486	39349	15633	1248906
	D	42046	60227	87006	197090	121054	70455	30681	24128	24396	8912	665995

	E	93578	146215	221910	629799	445669	196964	55793	73389	82920	31405	1977642
all the items		245375	330352	498910	1280927	1005711	635677	266397	218727	235419	101609	4819104
One-dwelling houses												
A		1263	1813	2878	7949	8435	13922	14026	16851	21021	11319	99477
B		20969	27283	49399	115258	123489	133689	69482	57033	65245	33443	695290
C		68060	80296	121104	310246	283702	180311	62805	41855	38845	15486	1202710
D		40704	59044	85540	193867	118664	68842	30071	23784	24120	8841	653477
E		91222	144204	219497	623420	439953	194265	55204	72872	82530	31291	1954458
all the items		222218	312640	478418	1250740	974243	591029	231588	212395	231761	100380	4605412
Two-or-more dwelling houses												
A		296	276	339	543	517	859	796	333	334	146	4439
B		6759	5575	7268	7844	5602	6990	2608	1187	1121	437	45391
C		11045	7199	6087	7992	5670	3958	1249	611	497	143	44451
D		1319	1169	1449	3211	2385	1610	598	343	273	71	12428
E		2356	2011	2413	6379	5716	2699	589	517	390	114	23184
all the items		21775	16230	17556	25969	19890	16116	5840	2991	2615	911	129893
Stocks												
A		93	123	239	634	4822	22355	25352	2832	773	208	57431
B		742	976	2341	3397	6667	6059	3497	488	260	106	24533
C		524	369	339	175	84	115	108	20	7	4	1745
D		23	14	17	12	5	3	12	1	3	0	90
E		0	0	0	0	0	0	0	0	0	0	0
all the items		1382	1482	2936	4218	11578	28532	28969	3341	1043	318	83799

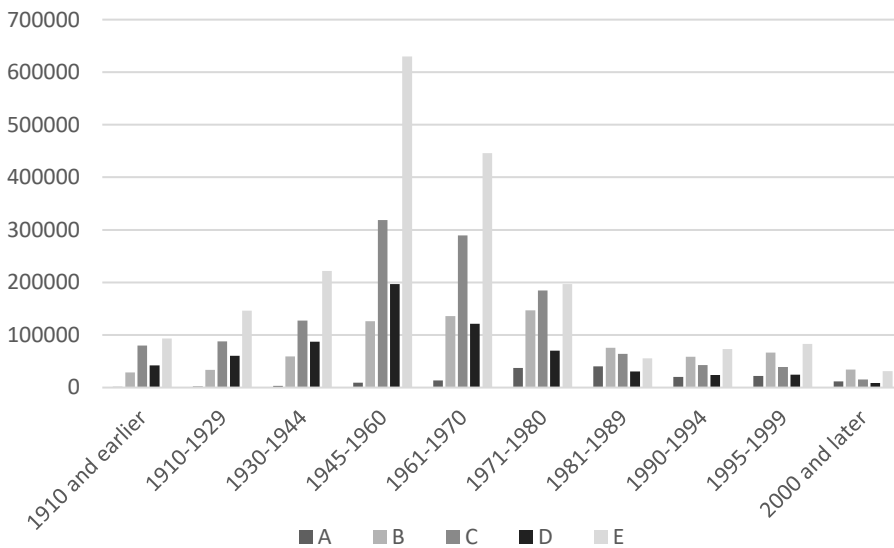

- A – Reinforced concrete, precast concrete panels, moment-resisting RC frame.
- B – Brick and stone masonry or panel replacements, made of RC.
- C – Brick and stone masonry or panel replacement, made of wood.
- D – Wood (beams, logs etc.).
- E – Samples plastered with wet clay, adobe, other materials (pressed panels, rolled mud bricks etc.)

Figure 29 – Graph representing number of buildings by period and construction type – Source: [72]



Figure 30 – Graph representing number of building stocks by period and construction type

Out of a total of 926'561 RC residential buildings (categories A and B), 81'964 units are building stock. The 94.3% of the residential building stocks were built before the 1990s and are potentially corresponding to the target of the research.

3.1.4 The Netherlands

Regarding the Netherlands, data provided by CBS Statistics Netherlands [73] and the results from IEE TABULA project [74] were examined, identifying the distribution of residential buildings by type and period. It turns out that on a total of 9'866'538 of buildings [75], about 7'266'000 (74%) can be classified as shown in Table 12 and Figure 31.

Table 12 – Number of residential buildings by period and construction type – Source: [74]

Data typology	number of residential buildings (absolute values)						
Year of census	2012						
Territory	Netherlands						
Construction period	Before 1946	1946-1964	1965-1974	1975-1991	1992-2005	2006-2011	Total
N° of dwellings (x1000)							
Detached house	0	441	119	221	178	78	1037
Semi-detached house	0	285	142	224	173	76	900
Terraced house, mid-row	337	296	375	572	241	106	1927
Terraced house, end-row	186	182	231	307	112	48	1066
Flat with common staircase and galleries	0	69	174	109	113	49	514
Flat with common staircase, no galleries	256	267	112	142	70	31	878
Maisonette	0	226	22	94	40	17	399
Other multi-family dwelling	0	99	125	125	136	60	545
Total	779	1865	1300	1794	1063	465	7266

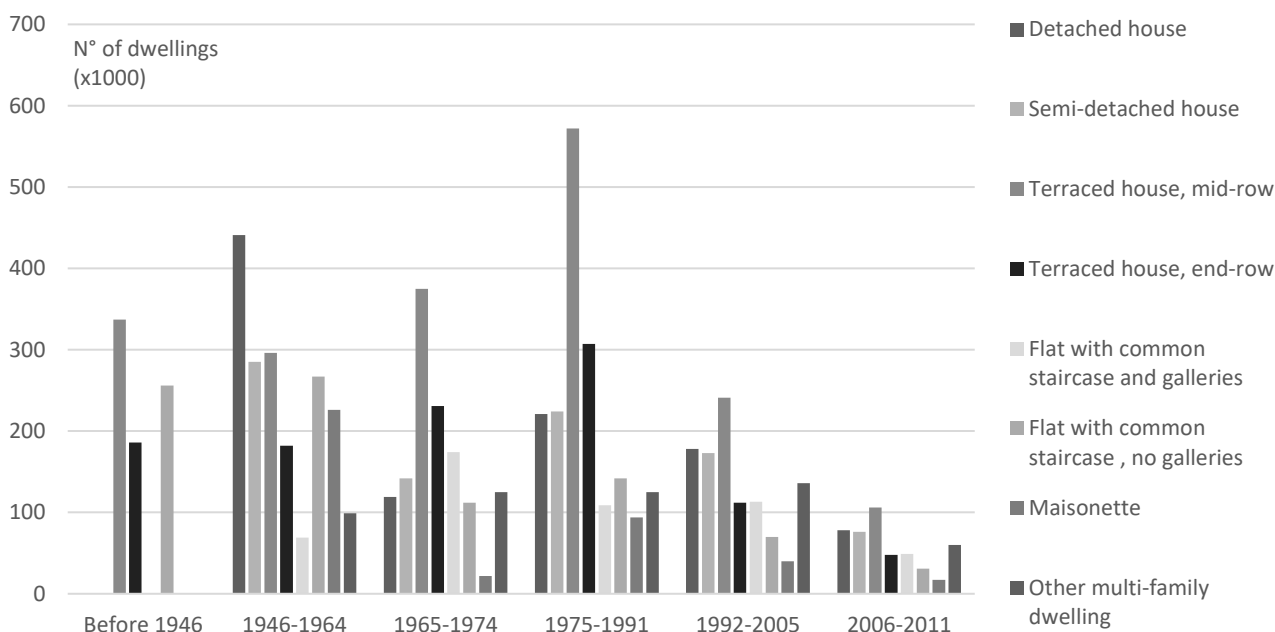

Figure 31 – Graph representing the number of residential buildings by period and construction type – Source: [74]

Not having more precise data, assuming that typologies such as flats, maisonettes and multi-family buildings, built after 1946 until the 1990s are mainly made of reinforced concrete, it is possible to obtain an assumed number of buildings for which energy-efficiency considerations may apply. Adding up these contributions, a potential number of 1'564'000 RC buildings could be obtained, representing 21.5% of the existing residential buildings in the Netherlands.

3.1.5 Spain

Finally, an overview of potential RC residential building stock in Spain is presented. Data provided by INE 2001 [76] and the results of IEE TABULA project [77] have been examined, identifying the distribution of residential buildings by type and period (Table 13 and Figure 32).

Table 13 – Number of residential buildings by period and construction type – Source: [77]

Data typology	number of residential buildings (absolute values)										
Year of census	2001 and 2011										
Territory	Spain										
Construction period	Before 1900	1900-1920	1921-1940	1941-1950	1951-1960	1961-1970	1971-1980	1981-1990	1991-2001	Total (2001)	Total BS (2011)
N° of dwellings											
Single unit houses (1 apartment)	767656	354954	405196	435942	679882	761201	1084141	1096051	1097568	6682591	-
Multi-unit houses (≥ 2 apartments)	132086	71292	91147	102782	205484	327792	418935	262965	318342	1930825	-
Building Stock total	899742	426246	496343	538724	885366	1088993	1503076	1359016	1415910	8613416	9804090

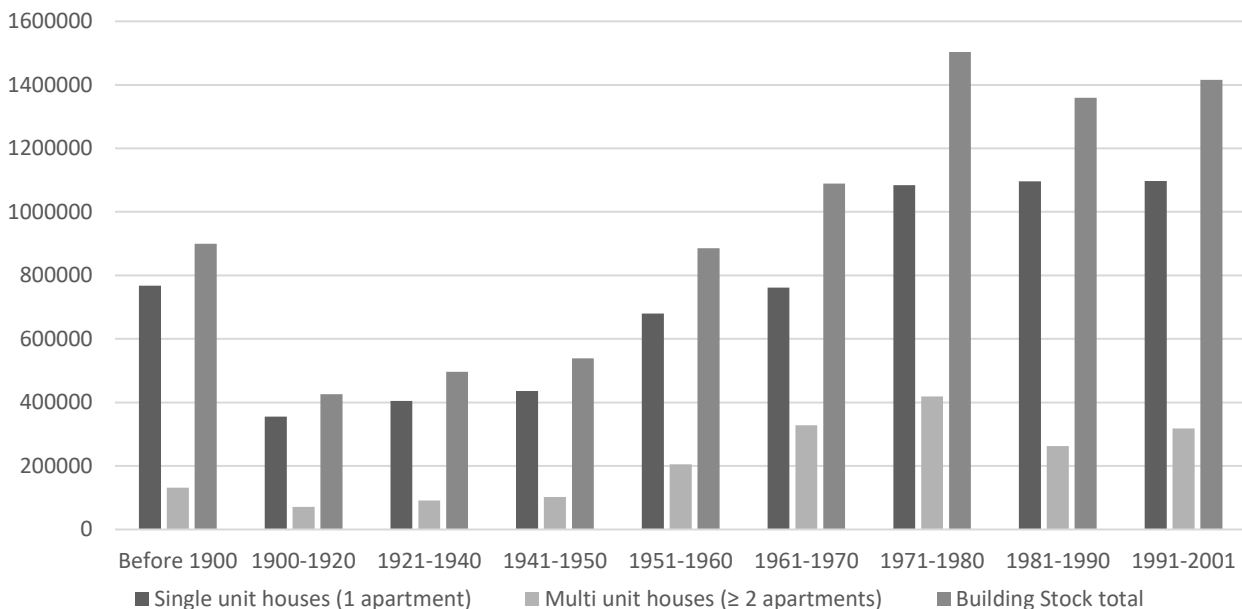

Figure 32 – Graph representing the number of residential buildings by period and construction type – Source: [77]

Assuming that the buildings belonging to the building stock built from the 1950s to the 1990s are predominantly made of reinforced concrete, it is possible to obtain a targetable sample of about 4'836'451 buildings, which represents 26.3% of the total number of residential buildings.

The management and maintenance of housing stock as a national and private asset is a widespread problem; but it is of primary importance for the countries of the European Union. As summarised in this paragraph, each country has a considerable share of the stock in urban areas. From a social point of view, it is often difficult to find supportive and organised neighbourhood communities, at the expense of frequent violations of internal laws. Thus, housing is not a political priority and, even if investments in the building sector are mostly available, it is often very difficult to convince several owners to renovate their building due to lack of liquidity or clear/immediate need. In fact, if from a structural point of view not all buildings are at risk (either due to good structural performance or low exposure), from a physical/energy point of view practically all the above-mentioned buildings are characterised by intrinsic problems due to a progressive understanding of environmental and sustainability issues that nowadays lead to the need to drastically reduce greenhouse gas emissions worldwide.

3.2 The energetic performance in existing RC buildings

A correct contextualization of the energy problem in its interaction with buildings and, more generally, with human activities and environmental changes, must refer to the conditions of growth that continue to characterize the phenomena of transformation of our planet. The concentrations of gases, which are progressively increasing in the atmosphere, accentuate the phenomenon of global warming. Since the problem of global energy supply and its end-use applications has been addressed in the absence or only partial awareness of this threat, a general reform of economic activities will be necessary in the near future to meet the challenge of reducing greenhouse gases [78]. In the building sector, in the last decades the progressive interest produced by the introduction of multiple innovations aimed at saving and producing energy from renewable sources (RES) is evident. The progressive diffusion of technological systems aimed at saving and producing energy, labelled as "Green Architecture" and, more recently, as nearly Zero Energy Buildings (nZEBs), is particularly evident if consideration is made on the increasing number of low-energy-consumption buildings and on the relative attention given on mass media, trade magazines and scientific journals [79].

Although the use of products, procedures and methods aimed at sustainable architecture on buildings has grown exponentially, its origins are relatively old. The Bliss House [80] and the Korsgaard House in Denmark [81], for example, represent the first attempts to eliminate the demand for heating through the pioneering use of solar collectors and heat-storage systems. However, it can be argued that today the knowledge and the operational capabilities to design and construct buildings in large urban sectors have reached a level where entire cities can be planned with low-energy or even zero-energy consumption [78].

With regard to the regulatory framework, on 27 March 2013, the "Green Book" on energy and climate policies was published, a document for a greener and more sustainable society, describing the objectives and methods for tackling environmental change. This document described the objectives and methods for dealing with environmental change. The document was referring also to energy performance of buildings, stating that, given the reform in 2010 of Directive 2010/31/EU, Member States must apply minimum energy performance requirements to new and existing buildings, and must ensure that all new buildings are "nearly zero-energy buildings". Directive 2010/31/EU, as amended by Directive 2018/884/EU, aimed to improve the energy performance of buildings in the EU, but above all was setting minimum performance requirements and conditions for new buildings, with a particular focus on technical systems. Directive 2018/884/EU, moreover, introduced "smart readiness" indicators that measure a building's ability to adapt its energy consumption to the real needs of its inhabitants, by improving its operation and interaction with a collective network. Similarly, in the United States, the Department of Energy (DOE), as part of its energy-efficiency actions and renewable sources Energy Building Technologies (EBT) approved a program that has the same objective: zero energy buildings (ZEBs) by 2025 [78].

The great interest in sustainable construction, the awareness of the technical feasibility of zero-energy buildings, the provision of recent European and national directives on the energy performance of buildings and the availability of increasingly accessible technological solutions are currently fuelling the sustainable transition in the building sector. However, all these aspects together does not seem to correspond to a consequent or extensive integration into current construction practices, nor to a clear definition of the typological, economic, and social implications of energy-issues in architecture [78]. The numerous, but not widespread, cases of sustainable architecture are often isolated or located in the framework of master-plans conceived, according to the logic of incremental development, in the context of transformations of "radical urban surgery", producing an impact that still seems to be negligible on current building practices [78].

In this context, it should be noted that, despite the incentive policies aimed at the diffusion of renewable energy technologies [82], and the progressive growth of policy incentives on climate change [83], substantial further investments are needed to reduce carbon emissions and fossil fuel consumption. Sector

studies developed by various NGOs [84] indicate that a fourfold increase in investments in the energy market will be needed to achieve the proposed carbon reduction targets [78].

The situation of the European building stock, as introduced in the previous paragraph, is characterised by buildings constructed before the entry into force of restrictive regulatory measures with respect to the reduction of energy consumption, rational management of resources and efficiency of installations. The EU building stock accounts for up to 40% of the final energy demand used for heating our houses [85]. Therefore, the most promising contribution towards the reduction of energy-consumptions and related CO₂ emissions in the building sector should aim to this energy demand. The high potential in terms of energy-savings represented from the buildings from the 1950s to the 1980s is shown in Figure 33.

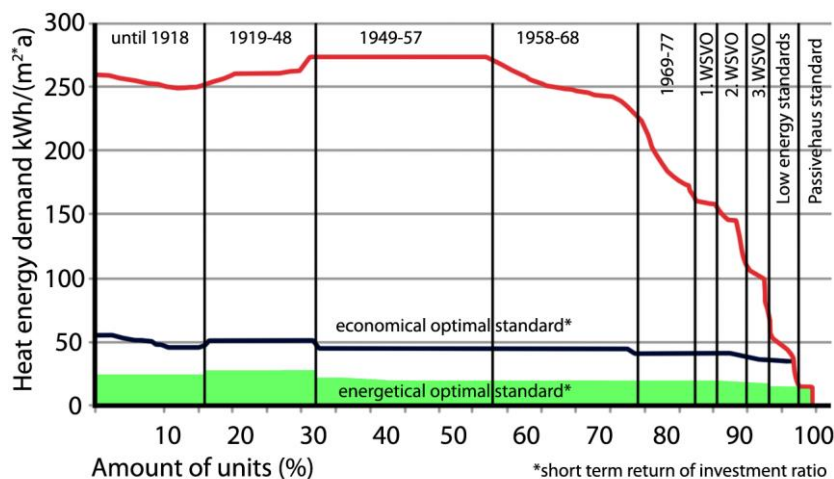

Source: ARENHA 1993, IWU 1994, Bundesarchitektenkammer 1995, Schutze Darup 1998/2000

Figure 33 – Building stock clustered in building age classes and its specific heat energy demand – Source: [85]

On current examination, the energy performance of these buildings generally shows inadequate insulation, low thermal-inertia, and low permeability, with the result that the technical systems are often overloaded, during both winter and summer [78]. Missing or minimised insulation, massive thermal bridges, and poor energy performance of window frames with single glaze determine high conductivity values (U-values) and high heat losses. Thus, due to their low inertia, external walls do not allow adequate attenuation and shift of the heatwaves. In terms of thermo-hygrometric condition and comfort it translates into incapacity of the systems to confer adequate temperatures and humidity to the various spaces of the building. This results in an immense heating energy demand in the range of 150 – 250 kWh/m² year) compared to 50 kWh/m² year prescribed for a low-energy building [85].

Table 14 – Progressive German thermal protection regulations compared to “Passivhaus” rules – Source: [85]

	1. WSchVO 1977, k-values [W/m ² k]	EnEV 2009. U-values [W/m ² k]	“Passivhaus” new building
Windows (glazing)	3.0	1.3 (1.1)	0.8 (0.65)
Walls	0.78 (A/V > 1.2) -1.4 (A/V < 0.24)	0.24	≤ 0.15
Roof (flat)	< 0.45	0.24 (0.2)	0.12 (0.1)
Basement floor	< 0.8	0.3	≤ 0.15

While Table 14 shows the progressive reduction of U-values requirements over time and awareness of energy efficiency, in Figure 34 a similar trend in heat consumptions can be recorded for the Italian context.

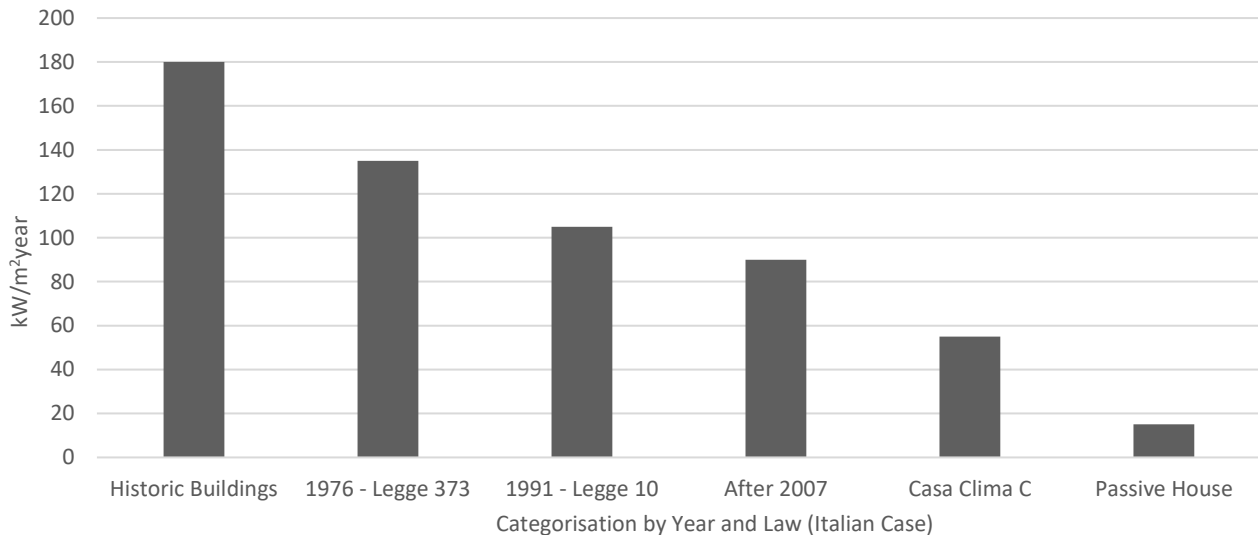

Figure 34 – Progressive heating consumptions in Italy during time towards passive house standards

It can therefore be seen that the stability and structural safety of RC buildings are often compensated by very poor performance in terms of sound and thermal insulation. If this aspect can generate an urgent request for renovation; this request must evaluate weighing increase in costs and greater technical and operational complexity of the interventions. This assessment can establish technically adequate, if not preferable, hypotheses of retrofitting interventions with high degree of transformation of existing buildings [78]. Nowadays, in a period of deep economic crisis, it is certainly preferable to plan small and medium-scale renovations of existing buildings rather than to plan large-scale new construction projects. It is well known, in fact, that energy retrofitting measures of the existing building stock can also be done by punctual interventions and modest interferences with the building, such as, for example, measures for the energy efficiency of heating systems, which offer a significant opportunity to reduce primary energy consumption and CO₂ emissions. In addition, technological solutions for the energy efficiency of existing buildings concern the elements of the envelope; in particular, that complex set of physical factors and technical-architectural components that most affects the energy behaviour, formal characterization, and figurative quality of buildings. The techniques for adapting the envelope to the performance requirements (in terms of reduction of thermal conductivity and, in general, control of physical-environmental factors) may vary from standard operations and interventions (insulation, replacement of window components, etc.) to transformations capable of modifying the envelope and the entire structure of the building; also, through volumetric addition/subtraction and architectural reconfigurations.

The technologies available are extremely articulated and make it possible to carry out interventions with materials and techniques with often proven effectiveness in practice. In order to categorise and list the operations that lead to the energy renovation of a building, it is sufficient to respond to the requirements mentioned above.

- Improving the internal distribution of the rooms by optimising solar inputs in relation to the geographical position and orientation of the building.
- Reducing/removing heat-loss through the envelope: increasing the thermal performance of walls in contact with cold rooms, replacing inefficient windows and doors, limiting/removing the resulting thermal bridges, and reducing heat-loss through ventilation or permeability.
- Innovating heating and cooling systems: adjusting generation, distribution, regulation, and emission systems based on the energy balance of the building with an efficient envelope. The systems currently in use have low efficiency values because they are technically outdated and would generate too much energy for buildings with high-performance envelopes.

Referring only to the envelope and the related technologies, possible energy efficiency measures can be divided into two-dimensional (2D) and three-dimensional (3D) measures. The first, and most consolidated in practice, are [86]:

- contact systems: external and internal claddings, false ceilings and floor additional layers;
- dynamic systems: ventilated claddings;
- active systems: capturing plasters based on transparent insulation materials, water-activated false ceilings and radiant floors and air-convection radiant false walls.

Otherwise, 3D systems provide:

- lateral extensions and continuous (stacked) or discontinuous local extensions;
- upper extension with or without suspension;
- interconnections between buildings, connections at base level.

From an architectural point of view, volumetric extensions (3D) over time also constitute a strong socio-cultural provocation, since they alter the aesthetic and technological fixity of the homogeneous, standardised façades of social-housing peripheries, violently rejected by the inhabitants who find no points of reference or identification in them. Projecting elements generate different levels on façades through shadows, overhangs, and recesses promoting architecture as a spontaneous evolution of the habitat. The ductility of the volumetric extensions allows a variation of morphology, thermal and acoustic insulation properties, internal and external finishes, size of the openings and presence of solar shading devices, in other words customisation of the living unit on the basis of the user's individual needs, guaranteeing adaptability to different contexts without changing the basic technological concept [86]. The application of these technologies allows existing façades to be differentiated according to different solar exposures or for pure character/aesthetic needs, constituting examples of design synergies involving architectural and energy aspects. Thus, providing also economic and social compensations for the costs and investments necessary for energy requalification [78].

3.3 Synergy in building renovation projects

The EU energy efficiency challenge in buildings is mainly about energy efficient renovation and related investments. However, as far as the private building market is concerned, there are clear gaps in the retrofit process. Cost-benefit assessments of retrofits show excessive payback times (up to 35-45 years) [1]. In addition, high initial investments are required which are generally characterised by a high degree of risk and limited return potential. In the Mediterranean and seismic areas of the EU, where market conditions are weaker, this gap is even greater, due to an association with a strong and generalised lack of confidence by the end-users and owners. To overcome the barriers of high costs and long payback times, several studies have already been conducted proposing technological solutions using prefabricated systems such as TES Façade [85], More Connect [87], and other prefabricated systems for energy renovation [1].

The prefabrication strategy is based on the principles of off-site production and derives from the know-how of prefab timber construction. Prefabrication leads to more efficient and time-saving on-site assembly. The production processes of the components can take place either completely in the factory, or alternatively mobile field factories can be considered, based on different advantages. The analysis of the assembly and construction process of different case studies allows the development of a generic process structure, based on the following principles [88]:

- standardised raw materials and construction products;
- modular geometry and composition rules of the basic material;
- defined interfaces between the elements;
- industrial level production system of the panel system;
- standardised logistics, assembly processes and connection of modular panels;
- provision of specific assembly-tolerances.

3.3.1 State of the art of multiple benefit approaches

Part of the research concerns the development of envelope technology integrated into the structural system for seismic improvement. As introduced in 3.3.2 it is the synergy of different interventions that makes the proposed system innovative. In this section some examples of interventions, both from literature and practice, in which architectural and energy components have been combined for this purpose are cited.

In [86] the adoption of a technology already widespread in the early 2000s, especially in Germany, called Structure/Cladding (translation of *Struttura/Rivestimento* from [86]) is categorised. It is essentially based on the dry assembly of lightweight and functionally specialised elements on bearing structures independent of the existing building. This construction method involves the realisation of technical components specifically developed based on project requirements. The independence of each individual cell confers freedom to assemble sealing layers, finishing surfaces, insulating panels etc. until the desired performance is achieved. In addition to the performance-oriented technical aspect, the possibility to adjust the costs of the intervention (by varying the technology adopted), the propensity to integrate the technical systems (pipelines, ducts, etc.), the reversibility of the intervention and the not negligible aesthetic factor, enhance and promote this type of intervention.



Figure 35 – a) Various possibilities on a single cell with the Structure/Cladding system; b) Retrofitting intervention of a Plattenbau in Leinefelde, Lessingstrasse (Germany), Stefan & Schnorr Architekten, 2000 – Source: [86]

TES Energy Façade [85] is a systemised retrofitting method, developed by the Technical University of Munich, which provides off-site prefabrication of customised timber façade panels to replace parts or the entire envelope of existing buildings. Table 15 below sets out the main points of the system as the foundations of a philosophy that unites all these experiences in the research for holistic technologies to stimulate the energy-renovation of existing buildings.

Table 15 – Main characteristics of the TES method – Source: [85]

Main construction points	Added values	Added knowledge
<ul style="list-style-type: none"> • Energy efficient retrofitting of façades and roof with self-supporting timber frame structure • Renewal or improvement of windows • HVAC modernisation and integration of solar-active components etc. • Extensions, annexes, or the addition of spatial elements 	<ul style="list-style-type: none"> • Architectural renewal of façade materials and openings • Improved energy performance and living comfort • Sustainability due to use of timber-based materials • One-site productivity, fast assembly procedure, minimum noise, and disturbance • Maintenance oriented and end-of-life design (LCA methods) • Higher return on investments due to quality, holistic solutions, and industrial productivity 	<ul style="list-style-type: none"> • Systemised workflow • Digital survey using reverse engineering methods • Holistic planning process through BIM (design, realisation, and maintenance)

The TES method goes through four main steps: survey, planning, production off-site, assembly on-site. Prefabrication demands detailed information on the renovation object in order to fabricate the customised components that through a short assembly process on-site guarantee low disturbance compared to conventional renovation methods. The technical final components combine a self-supporting structure with insulation infill and panelling, which can be made of a wide range of cladding materials (e.g., timber boards, timber panels, glass, aluminium etc.). The modularity of the prefab components allows an easy integration of windows, building service systems and ready-made surfaces of the façade elements. In the timber construction sector, prefabrication methods are diffuse and successfully implemented and, in this case, provide a flexible workflow from design to customised production, thus timber-based materials gain added importance due to their positive primary energy demand from cradle to grave and carbon-footprints [85]. The geometry of the building may be modified by adjusting openings and integrating loggias or balconies to the heated living area. Updating the building stock often requires retrofitting strategies that not only improve the technical performance of a building but also adjust space and appearance and thus the architecture. These include the integration of technical systems, solar design and extensions or changes to the existing floor plan structure. Starting from a basic element (Figure 36a), generally composed by adaptable solutions divisible into insulation, panelling and structure, several approaches are investigated varying size, module, orientation and supporting conditions (Figure 36b and c).

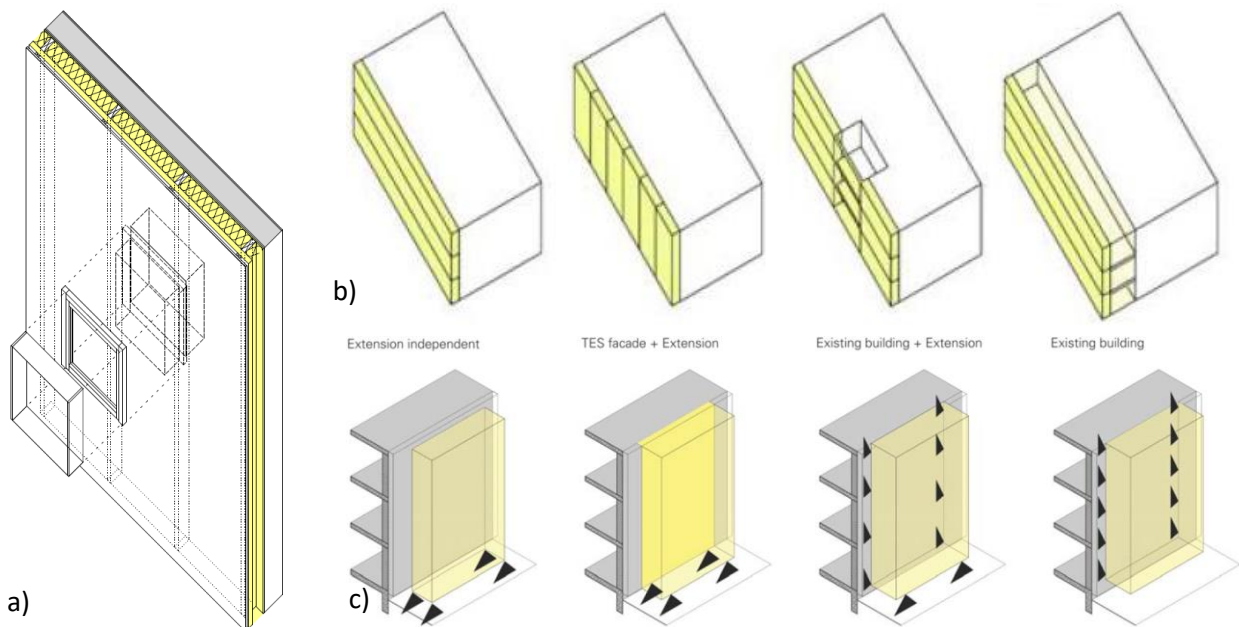

Figure 36 – a) Basic TES element with insulation, panelling and structure ; b) horizontal and vertical division – spatial enclosure and extension; c) typology of mounting elements – Source: [85]

Very similar to the TES method is the experience of the Horizon2020 MORE-CONNECT project [87]. Modular prefabricated elements were developed for the insulation of the building envelope aiming at nZEB levels of renovation. Like the previous example, the process went through an extensive survey (including hygrothermal measurement and moisture safety analysis), the fabrication of highly insulated prefabricated modular façade and roof components, and a complete modernisation of the heating and ventilation systems, providing ventilation ducts integrated into the modular panels to minimise supply ducts into the flat. The roof modules include solar panels and collectors for renewable energy production, as well as a rainwater drainage system. The conductivity values of the prefabricated modular panels reached values characteristic of a nZEB building (Table 16), identifying one of the most critical design tasks as the selection of a vapor barrier to avoid problems dry-out of possible constructional moisture [89].



Figure 37 – a) Overview and thermal camera images of the MORE-CONNECT pilot building in Estonia before-renovation; b) graphic rendering of the laser scanner survey with indication of the shooting positions; c) example of designed solution with integrated ventilation ducts; d) photos of the production off-site of the panels, the assembly on-site and the final result – Source: [87, 89]

Table 16 – Modified U-values, before and after renovation with modular prefabricated panels – Source: [87]

	U-values [W/m ² K]						
	Denmark	Estonia	Latvia	Czech Republic	Portugal	The Netherlands	
Before renovation	U_{wall}	0.50	1.10	1.10	0.80	0.92	1.90
	U_{roof}	0.40	1.00	1.25	1.00	0.94	2.80
	U_{floor}	0.50	0.60	0.49	1.28	0.78	2.00
	U_{window}	3.10	1.60	2.56	1.12	3.10	2.80
	U_{door}	3.10	1.60	2.56	3.46	3.10	2.50
After renovation (nZEB)	U_{wall}	0.14	0.08	0.08	0.21	0.47	0.18
	U_{roof}	0.11	0.06	0.08	0.15	0.32	0.15
	U_{floor}	0.34	0.15	0.11	0.27	0.86	0.29
	U_{window}	0.70	0.60	0.81	1.00	2.40	1.60
	U_{door}	0.70	0.80	0.81	1.00	2.40	2.00

As already introduced in the first two cases, energy upgrading can be accompanied by volumetric extensions that modify the architectural component according to the needs of the specific case. In addition to collaborating in the performance of the envelope, these extensions create filtering environments between internal and external space and/or additional spaces that increase the value of the building and sometimes the usability of the spaces themselves. An interesting case study adopts this strategy even on historical buildings. This is the case of the energy and architectural renovation of the second cloister of Sant'Antonio in Polesine in Ferrara [90]. From the energy point of view the intervention provided the replacement of technical heat ventilation and air-cooling systems (HVAC) together with the placement of 60 mm thermal plaster where possible, or 80 mm of wood fibre boards on the inside where the historic façade had to be preserved. In addition, a second façade leaning against the original wall creates a filter between external and

internal environments. An environment (facing N-W) which is not air-conditioned but which, with controlled and localised openings, controls the exchange of air and ventilation to ensure tightness in winter and good circulation in summer. Semi-transparent photovoltaic panels also provide summer shading for the glazing to avoid the greenhouse effect. Overall, the improvement passed from an energy-consumption of 70 kWh/m³ (class F in the Italian classification system) to 11 kWh/m³ (class B). From a functional point of view, this volumetric extension has made it possible to build an additional walkway, connecting the various exhibition spaces of the building; while from an architectural point of view, the choice of glass contrasts with the massive nature of Italy's historic buildings, creating a dialogue through the transparency of the new envelope.

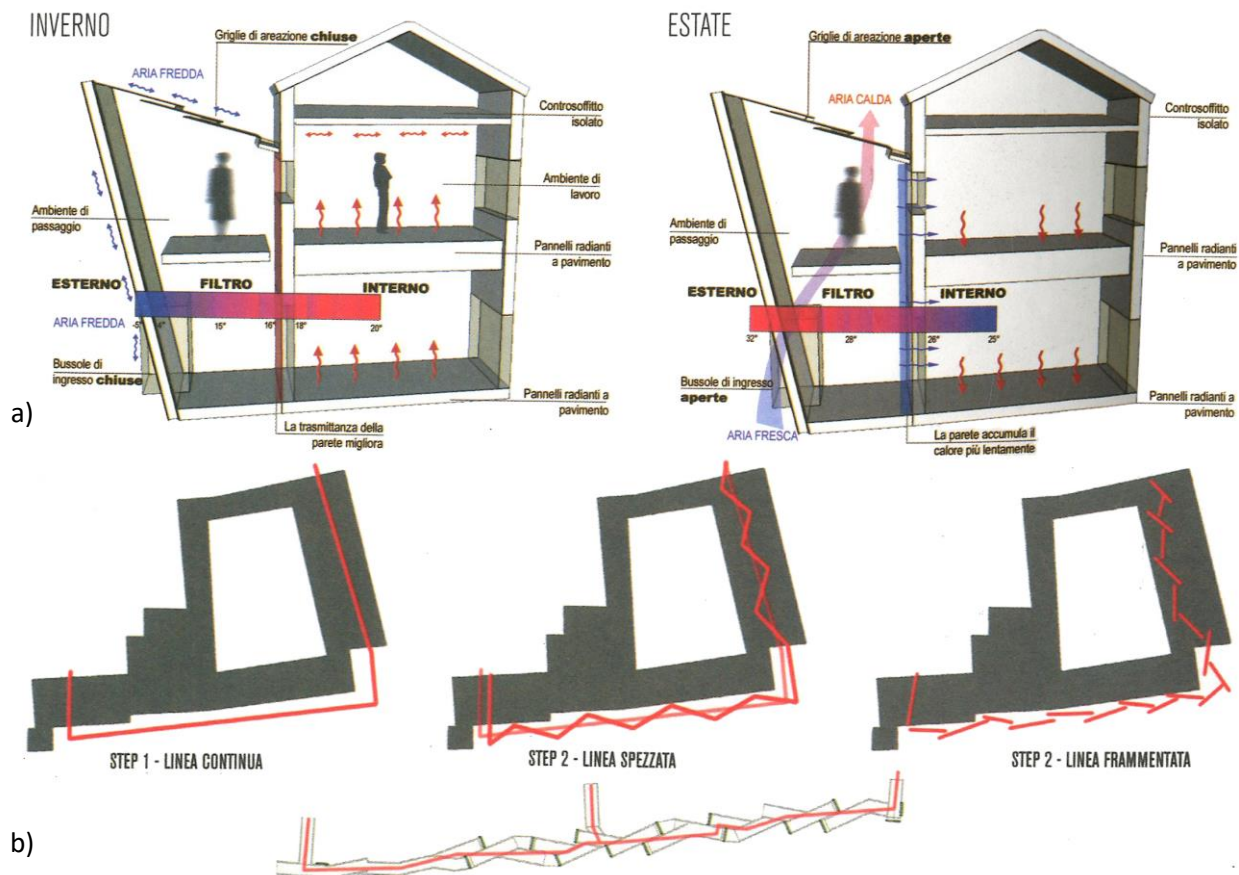

Figure 38 – a) New environmental system created by the glazing extension and winter and summer behaviour depending on the opening configurations; b) scheme of the new exhibition path – Source: [90]

Remaining on the subject of volumetric extensions, but returning to the residential context, it is important to mention the European project ABRACADABRA (Assistant Buildings' addition to Retrofit, Adopt, Cure And Develop the Actual Buildings up to zeRo energy, Activating a market for deep renovation) [91], coordinated by the University of Bologna. The concept of the project completed in 2019 was to explore the possibility of increasing the real estate value of existing buildings to support a deep and widespread renovation of the urban context. Key points of the project are:

- the reduction of the payback time on investments for energy improvements;
- reinforcing investor confidence;
- increasing the quality and attractiveness of improved existing buildings;
- an acceleration of the market towards nZEB objectives.

The strategy of the project was to demonstrate how volumetric extensions (lateral, façade, roof extensions or complete replacement) can create a system of Assistant Buildings' Addition, integrated with renewable energy sources that can create a network of punctual implementations in line with densification policies that characterise European urban contexts.

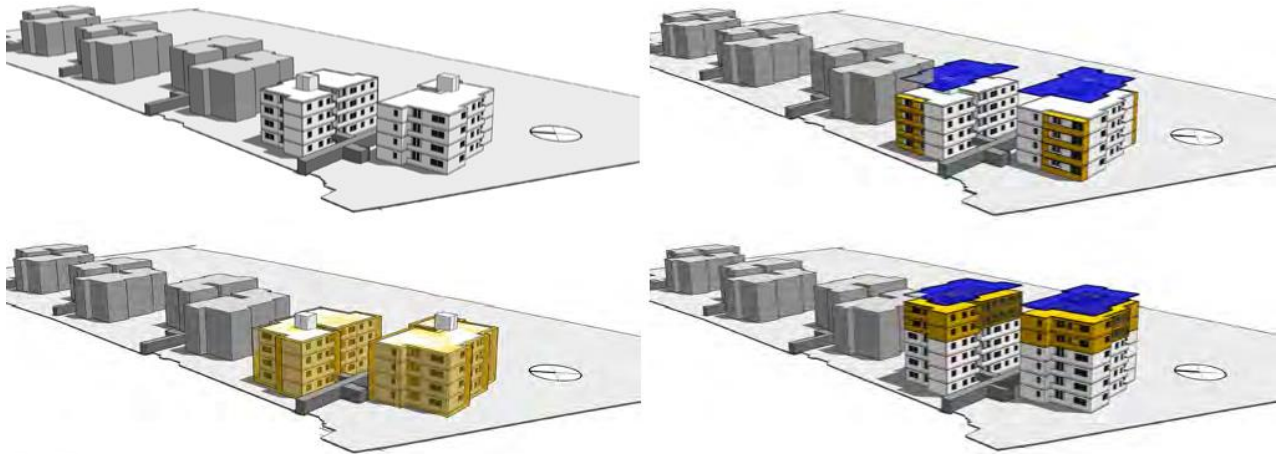

Figure 39 – Typologies of extensions promoted and investigated in the EU project ABRACADABRA – Source: [92]

Referring to the German case, some data, diagrams and examples from best practice and a presentation done by Prof. Dr.-Ing. Karsten Tichelmann from the Technical University of Darmstadt are given below [93]. He stated that the actual need of ca. 1.5 million housing units (with an average living space of ca. 85 m²) could be created without additional site development and new land sealing through vertical extensions (densification) that would simultaneously improve the building culture. Table 17 shows some technical and constructive key points and percentages on densification in Germany and Figure 40 an example of two storeys vertical extension in Rüsselsheim.

Table 17 – Potential percentages of buildings in Germany that could be targeted for vertical extensions – Source:

N° of storey	Stacked storey	1 storey extension	2 storeys extension	3 storeys extension
Potential for storey additions	60% - 90% of building stock	85% - 90% of building stock	35% - 45% of building stock	2% - 5% of building stock
Feasibility for storey additions	Setbacks of stacked storeys are causing problems in transferring the loads to the supporting structure	Good feasibility, load transmission is elaborate at complex structure systems, roof shapes and special rooftops	Elaborate when the load reserves of structure systems and footing are exceeded	Excesses of load reserves are expectable at multi-storey-buildings with less than 5 storeys. Mostly an increasement of footing and structure systems is required



Figure 40 – Example of vertical extension with a floor-area densification ratio of 1.5, OPEL company owned apartments, Rüsselsheim – Source: [93]

The conversion of building through vertical extension, made by lightweight prefabricated units (including integrated technical systems), could ensure great flexibility, easy integration of mechanical and electrical services with a cost-effective (Figure 41) and more environmentally friendly solution with reduced disruption on the inhabitants (mostly constructing from the outside).

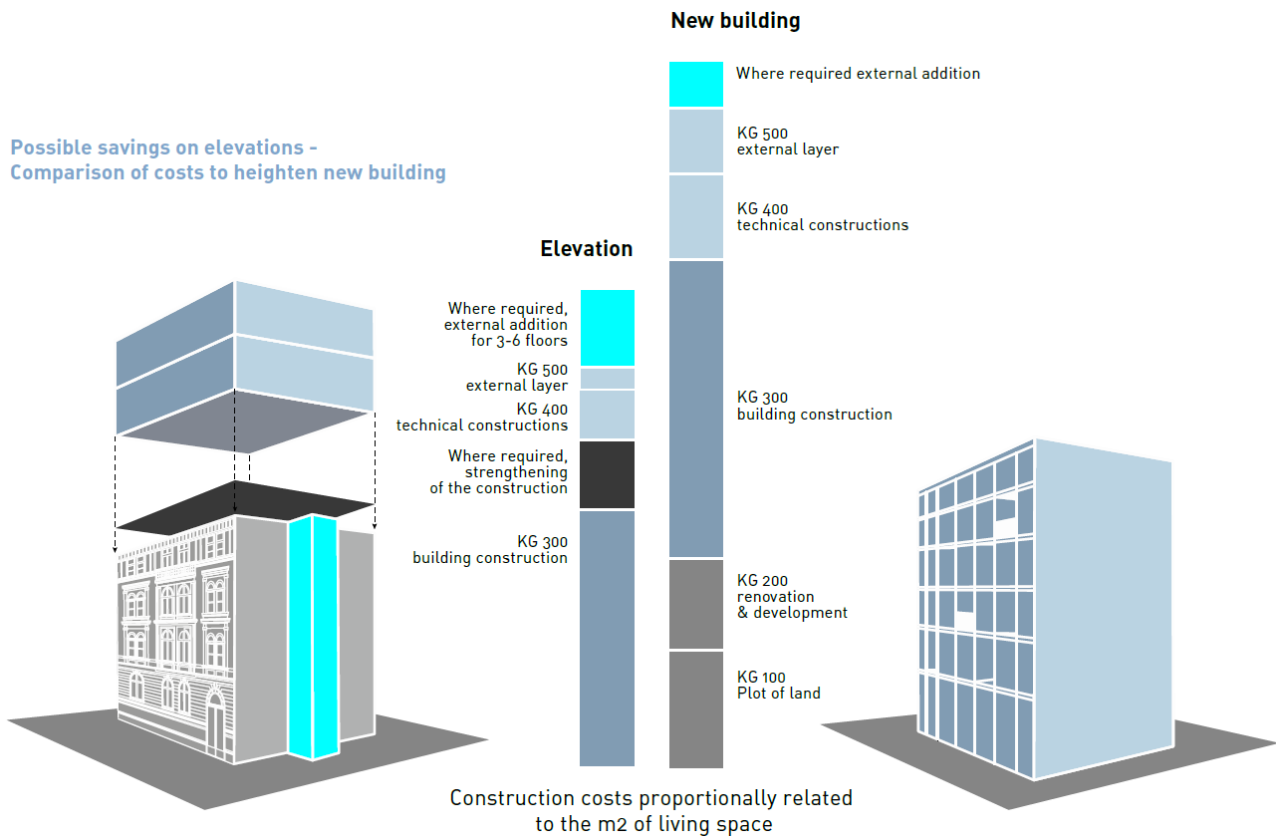

Figure 41 – Construction costs proportionally related to the m² of living space in Germany – Source: [93]

Finally, two best practices of façades extensions are mentioned among the works of architects Anne Lacaton, Jean-Philippe Vassal, Frédéric Druot and Christophe Hutin:

- the transformation of housing block in Paris 17^e, Tour Bois le Prêtre (Figure 42);
- the transformation of 530 dwellings in Bordeaux, block G, H, I (Figure 43, 44, and Table 18).

New floors, supported by an independent bearing structure (made of steel for the first case and of prefab RC for the second) are added on the periphery of the existing buildings at each floor level in order to extend the indoor spaces and creating closable terraces and balconies. Together with the assembly of the extension, the existing façades, characterised by small windows, are replaced by large transparent openings, so that the inhabitants could profit of enlarged views and additional sunlight. In both cases a renovation of the lower and common storeys was provided together with a replacement of the technical systems towards an optimisation of the energy efficiency of the building. The entire construction process was also designed in order to allow inhabitants to continuously living the flats, reducing allocations costs related to the renovation process. Therefore, the structure is designed with prefabricated elements to be easily and quickly assembled per floor on site. These constitute examples of relevant and economic transformations that produce, liveable, spacious, and performing dwelling.

It is a typology renovation that characterises RC residential building stock by improving comfort and reducing energy consumption at a cost comparable to a traditional renovation of the envelope. Indicating that cost forces designers to set priorities; in this case corresponding to functionality and efficiency.

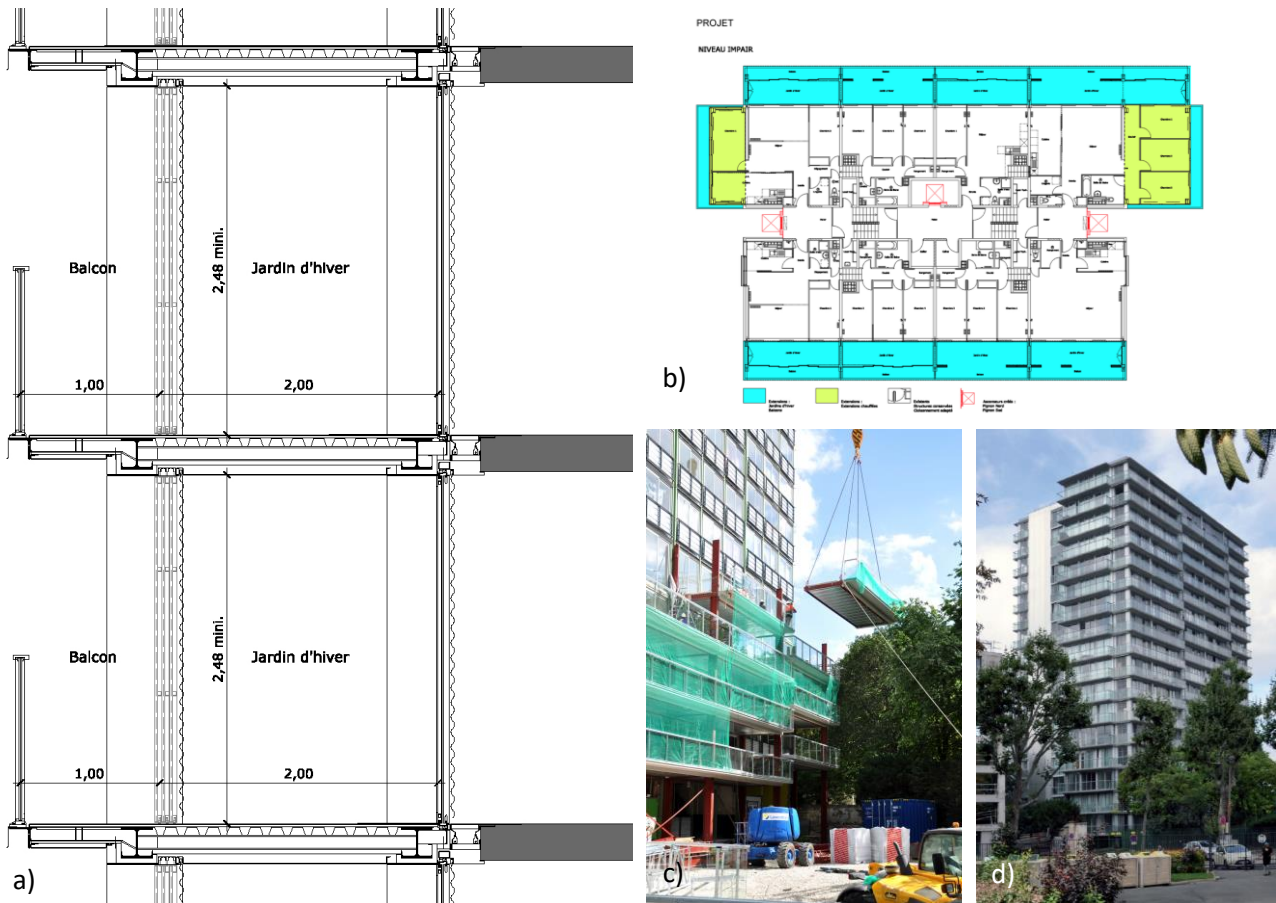

Figure 42 – a) Vertical cross-section of the extension made of steel prefabricated components attached to the existing RC slabs; b) horizontal cross-section of the typical plan highlighting the extensions; c) photo of the assembly procedure; d) photo of the completed renovation of the Tour Bois le Prêtre – Source: [94]

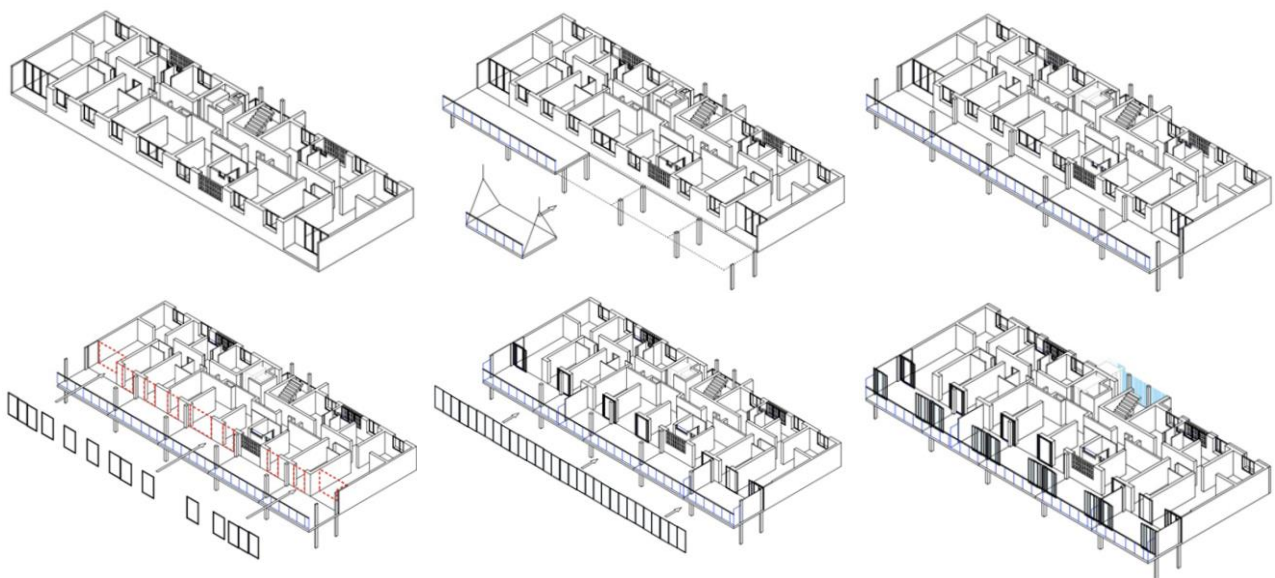

Figure 43 – Axonometric views of the assembly phase that characterised the renovation with extensions of the 530 dwellings in Bordeaux [94]



Figure 44 – Photo during the assembly phase of the renovation with extensions of the 530 dwellings in Bordeaux [94]

Table 18 – Summary of results/data related to the transformation of 530 dwellings in Bordeaux [94]

Transformation of 530 dwellings in Bordeaux, 3 blocks		
	Before renovation	After renovation
Floor area (m²)	44'000	67'000 (+53%)
Habitable area (m²)	33'095	36'724 (+7 m ² /dwelling)
Usable area (m²)	35'500	59'565 (+50 m ² /dwg)
Additional new spaces on rooftop (m²)	-	16'000 m ²
Energy saving on primary energy consumption (kWh/m²year)	153	48.8
Divided by the three blocks		
Cost of demolition and rebuilt	150'000 € net/dwg	-
Cost of the renovation	-	45'000 € net/dwg
Building occupied during construction	-	Additional benefit
No rent increase	-	Additional benefit

Most of these solutions are generally based either on independent structures or on the load-bearing capacity of existing buildings, the latter of which is often not applicable in the highly seismic areas of the Mediterranean countries. Thus, in the Mediterranean and seismic zones of the EU, it has become imperative to couple energy retrofit with the development of tools that increase confidence in safety, to demonstrate that higher initial investments are more attractive in the long-term than lower investments with higher paybacks. The undeniable costs and long payback times of retrofitting projects lead to the conclusion that there will never be an acceptable payback time for energy retrofits without considering a multiple benefit approach combining architectural/social, energy and structural contributions [1]. This triple combination of benefits is the foundation of the Pro-GET-onE research project [95], in which the research is directly focused. The central element of any renovation project is the increase of value for the client (investor, building owner and tenant) and focusing only on optimising energy efficiency proves ineffective on a large-scale by not meeting the overall needs.

3.3.2 Pro-GET-onE and its possible impacts

The research project Pro-GET-onE (Proactive synergy of inteGrated Efficient Technologies on buildings' Envelopes) [1, 95] focuses on developing integrated technological solutions to improve the energy performance and seismic safety of existing RC buildings. The criteria to be followed aim at sustainable and rapidly implemented solutions, which do not imply the interruption of the use of the buildings, and which also offer functional improvements to the housing units, with an extension of living spaces. A further objective is the definition of a design method that avoids the creation of ad-hoc solutions for each application case, but is based on the identification of replicable, prefabricated, and modular solutions based on dry-assembled components.

As seen in the best practices above, to achieve efficiency, attractiveness and marketable solutions, a holistic and integrated set of technologies can be proposed, optimally managing the different requirements (energy, structural and functional). HVAC and structural systems must be renewed together with the transformation of the envelope, in order to ensure cost-effective solutions that reduce the actual construction time, the disturbance for the inhabitants and deliver a fully renovated building with an extended life (as new). Therefore, the unprecedented integration of different technologies aims at high performance in terms of:

- energy performance: through the addition (or replacement) of new prefabricated and plug-and-play efficient cladding-components (wood-frame wall panels for opaque surfaces with integrated openings), new HVAC systems with related distribution, and RES systems (photovoltaic and/or solar panels);
- safety: providing external structures to increase the seismic performance of the existing building, such as new steel/aluminium shear walls or timber walls;
- social and economic sustainability: increasing the real estate value of the buildings and the attractiveness of retrofit solutions, providing tailored-made and customised units for users, owners, and administrators, increasing safety and minimising disruption for inhabitants.

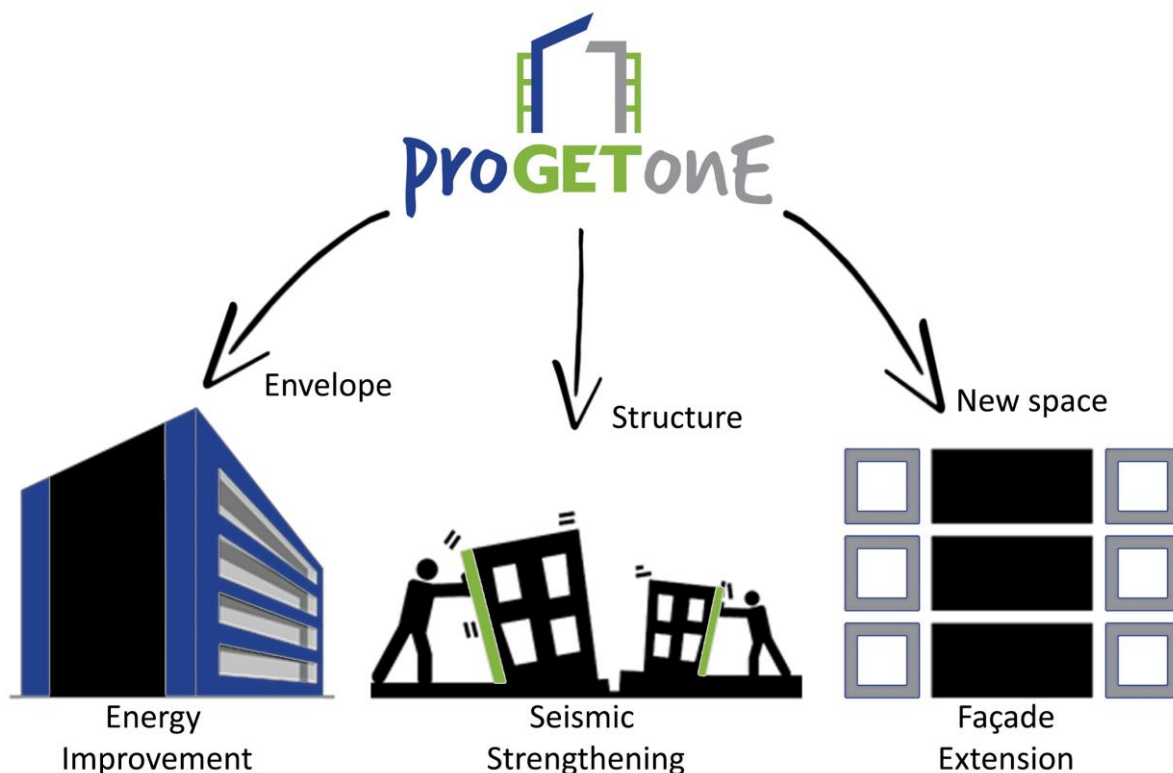

Figure 45 – Scheme representing the multiple benefits aimed by Pro-GET-onE

Pro-GET-onE is currently in its fourth and final year of development and is expected to lead to the construction of the prototype of the technological system applied to the student house of Athens; one of the three case studies belonging to the Mediterranean and/or seismic area of the project. These three cases will be the subjects for the assessments of the seismic improvement in Chapter 5. In addition, the technological solutions integrated in the structural system for the Greek and Romanian cases, in combination with the steel and the timber structures respectively, will be presented in Chapter 7. During the development of the project several contributions on the main topics of the project have been published. The structural seismic improvement has been proven with a steel three-dimensional exoskeleton [96, 97] and with a cross-laminated timber external strengthening structure [98], as presented in Chapter 5. Complementary to the external structure, architectural components are developed for the extensions of the building envelope [1, 88, 99]. The pre-assembled solutions had to face the challenges of architecture variability (extra-room, sunspace, and balcony), completing the strengthening structure, and were provided as prefabricated boxes or slabs, composed by combinations of cross laminated timber (CLT) panels and wooden frames (Chapter 7). Together with the increased space delivered by the extension of the exoskeleton, airtightness, insulation, and a new façade are provided by the components. These interventions result in higher energy efficiency, renewal of the building envelope, thus updated asset value [1]. Combined with new and efficient heat, ventilation, and air conditioning (HVAC) systems, their piping, and the inclusion of renewable energy sources (RES) on the roof, the architectural components aim to achieve levels as close as possible to nearly zero energy buildings [100-103]. Also noteworthy are the contributions that address the environmental impact of the project [104, 105], comparing different scenarios within the prototype-renovation and with respect to the demolition and replacement process. The results of these contributions will be further discussed in Section 4.4.

Pro-GET-onE identifies new processes to accelerate the competitiveness and attractiveness of energy efficient measures in existing and deteriorated urban complexes. In particular, the project implements interactions between different, and often segmented, market sectors to try matching the complexity of deep renovation in existing buildings. The technologies available in the building sector for deep-renovation strategies have been applied to a large number of buildings in Central and Northern Europe. Unfortunately, the same cannot be said for Southern and Eastern Europe, especially when considering those countries where building regulations on safety are closely linked to seismic criteria. By integrating energy aspects with seismic safety and social emergencies, Pro-GET-onE seeks to spread the concepts of deep renovation in countries such as Italy, Greece, Romania, etc. The impact in terms of number of buildings that could benefit from the application of these technologies is relevant as introduced in Section 3.1, favouring renovation through prefabrication models all over Europe. A summary of the expected impacts of Pro-GET-onE is then reported as completion of the overview on the EU project and therefore, on the boundaries of the research. The following main points are taken from results obtained by the Pro-GET-onE consortium [95].

Time reduction

The results of the first analyses on the assembly procedures show that the strategy can potentially halve the construction time compared to standard renovations; thanks to mass production and prefabricated systems. In particular, considering that:

- for energy renovation, the standard construction time was estimated to be about 6 months (including scaffolding, insulation, window replacement and installation of new technical systems);
- for structural strengthening, the standard intervention generally also takes about 6 months.

Taking into account the possible partial overlap of the above-mentioned construction phases, the total estimated construction time for standard combined retrofit interventions is approximately 9 to 12 months. Without considering the construction of the foundations and taking into account the possibility of using the new structure as scaffold during the tiered construction process, a reduction of the construction time to a total of 3 to 4 months was considered.

Energy-consumption reduction

Through the integration of the envelope and the replacement of the HVAC systems, the calculated energy consumption on the Athens case study is reduced from 28 to 18.2 kWh/m²year [103]. Furthermore, it has been demonstrated that the energy needs for lighting and heating decreased from 39.4 and 24.3 kWh/m²year before the retrofit to 17.4 and 0.9 kWh/m²year after the retrofit respectively; marking an overall calculated energy saving of around 86% [103]. The application of renewable energy systems (RES), directly integrated in the prefabricated elements for the renovation, allows to further decrease the overall energy consumptions of the building.

In a long-term perspective, considering the life cycle assessment (LCA) calculated over a building lifetime of 25 years, the project scenario produces less CO₂ emissions than demolition and replacement, and even less than the case of maintaining the building as it is [104]. Regarding payback time, energy savings were able in more than 50% of the scenarios calculated over 25 years, to pay back the investment and maintenance costs of the renovation [104]. When the assessment is extended to 100 years, 75% of the results are positive in terms of energy payback [104].

Cost reduction

The first evaluation showed that Pro-GET-onE was able to reduce the cost of the intervention by approximately 16.5% compared to typical renovation, combining energy and seismic safety improvements. In particular, considering that:

- for energy renovation, standard costs are estimated at around 360 €/m² (for Pro-GET-onE, 380 €/m²);
- for structural safety, standard costs are estimated around 390 €/m² (for Pro-GET-onE, 330 €/m²);
- for temporary accommodation of inhabitants, standard costs are around 100 €/m² (for Pro-GET-onE these costs are avoided).

In addition, it is significant to consider the added value in economic terms, of the extra floor space generated by the Pro-GET-onE system. The unit value of increased real estate has been estimated to be around 130-180 €/m², depending on the different regional markets. This consideration reduces the payback time and increases the impact of the project in terms of cost reduction, stating that Pro-GET-onE achieves a unit-cost reduction of up to 32%-38% compared to typical combined renovations.

More recent life cycle cost (LCC) analyses applied to the Athens case study stated that most of the results of the evaluated scenario foresee savings between €1 and €3 million compared to the demolition and replacement of the building [104].

Effectiveness

Although the results of the construction of the prototype in Athens will give the opportunity to evaluate the concrete impacts of the project, it is possible to state that by assessing and responding (through the use of a holistic technology) to energy and safety needs, together with the possibility of integrating the customisation of different architectural components, Pro-GET-onE boost the dissemination of renovation practices on existing buildings stock.

4. State of the art on external strengthening techniques

In Section 2.4 an overview of established retrofit strategies and the system is presented. From a technical point of view, the selection of the retrofit strategy should be guided by the results of a detailed assessment of the building. Deficiencies in the structure may be localised and involve few scattered components (elements or joints) or concentrated in one part of the structure due to an irregularity in the structural configuration (soft storey or presence of torsion), or alternatively affecting the whole building [9].

In the first case it is appropriate to pursue a strategy of local modification of the deficient components or joints, either by strengthening some vertical elements (e.g., in the soft storey or in the weak and flexible side of the building) or by adding some new elements, which are strong and rigid enough to remove or cancel the effects of irregularities (shear walls in the weak sides). Finally, removing material (infills) or changing imposed loads could also solve local problems [9].

When the assessment reveals a generalized deficiency throughout the whole building, a radical intervention may be required, by adding shear walls or bracing systems, which contrast with applying local strengthening strategies on most, if not all, the existing elements (especially the vertical ones). The latter is not advantageous in terms of costs, especially when disruption to the tenants, their allocation, and the demolition and replacement of partitions, architectural finishes and other non-structural components are considered. New shear walls or steel bracing systems protect the existing elements by reducing the global displacements under the design seismic actions, bringing them to levels corresponding to the deformation capacities. The disadvantage of these additional structures is that they can require intervention on the foundation system, which is usually an expensive, disruptive, and sometimes technically demanding operation. However, when interventions on the perimeter of the building are feasible, adding shear walls or steel bracing to the façades should be a favoured choice over a general element-retrofit throughout the building, especially if the occupation should be maintained during the retrofit [9].

Finally, techniques (or strategies) such as base isolation and energy dissipation are more suitable for seismic retrofitting of bridges or other existing infrastructures. Their application to existing buildings may not be cost effective [9], especially for base insulation which essentially requires a double foundation system. When the existing building provides sufficient stiffness, it offers the advantage of securing occupants and building contents (non-structural elements), even during very strong and rare events, constituting a preferred alternative for critical or important structures that must remain operational during design earthquakes or be available for immediate occupancy. Base isolation is a sophisticated and complex technique, and its application requires specialised knowledge and possibly, a peer review of the design [9]. On the other hand, energy dissipation systems require significant lateral displacements to be effective. Therefore, it can only be used in flexible structures, as a supplement to another system which does not significantly increase the overall stiffness (in combination with base isolation devices or with steel bracing systems). This technique is generally sophisticated as base isolation but less expensive [9].

It has been shown that the choice of strategy depends on several factors, including invasiveness, cost, overall behaviour, and critical aspects of the structure. Furthermore, it should be pointed out that the research context is determined by the objectives, presented in the previous chapter of the European project Pro-GET-onE and its case studies. This aspect will return in the following chapters to demonstrate that each existing building is characterised by a specific heterogeneity that makes it unique, with specific deficiencies and potentials, and that the generalisation of a seismic strengthening system, which respects the requirements imposed by the project, is a challenging task.

In this chapter some examples, taken from literature and best practices, will be introduced, concerning the development and evaluation of structural strengthening systems provided outside the existing building, constituting the state of the art with respect to the analyses presented in Chapter 5. The objectives of the project which translate into requirements for the structural system researched concern the minimisation of disturbance to the inhabitants, the need to develop extensions supported by the new

external structural system (three-dimensional structure outside the existing façade, exoskeleton) and the need to use pre-assembled components characterised by rapid dry assembly systems. The strategy identified to achieve these objectives, and to achieve a seismic improvement of the existing building, involves the use of an exoskeleton which in fact implies the insertion of shear walls as external buttresses.

4.1. Reinforced concrete walls

The use of infill shear walls has a wide application area for the strengthening of vulnerable structures [27]. In this context, the utilization of external RC shear walls was tested on RC specimens. Researchers tested both of the external wall schemes implemented in perpendicular [46] or parallel [47] to the side of the building.

In [46], Kaltakci et al. studied the use of RC shear walls applied on the external side of school buildings. They identified the advantages of avoiding the interruption of the internal activity during construction, without forcing students to leave the building for the time of construction, and reducing costs related to further repairs and renovations inside the building. In their experimental investigations, four identical RC frames with two storeys and two spans in a 1/3 geometric scale were produced (S-1 to S-4, Figure 46a), representing the most frequent construction type in Turkey with common deficiencies. Two of them were strengthened with an external shear wall, and all of them were tested under cyclic lateral loading representing the actual seismic loads. The columns were subjected to axial loads in order to create compressive failure in the columns simulating the recurring situation in Turkish schools, and the ratios of the longitudinal reinforcement bars were the additional variable in the experiments. For the anchorage, 8 mm diameter ribbed bars were used, at a distance of 150 mm, each starting 100 mm from the base. After the holes had been drilled and cleaned, 160 mm long bars were inserted and chemically fixed into the external shear walls (similar to what is shown in Figure 48a).

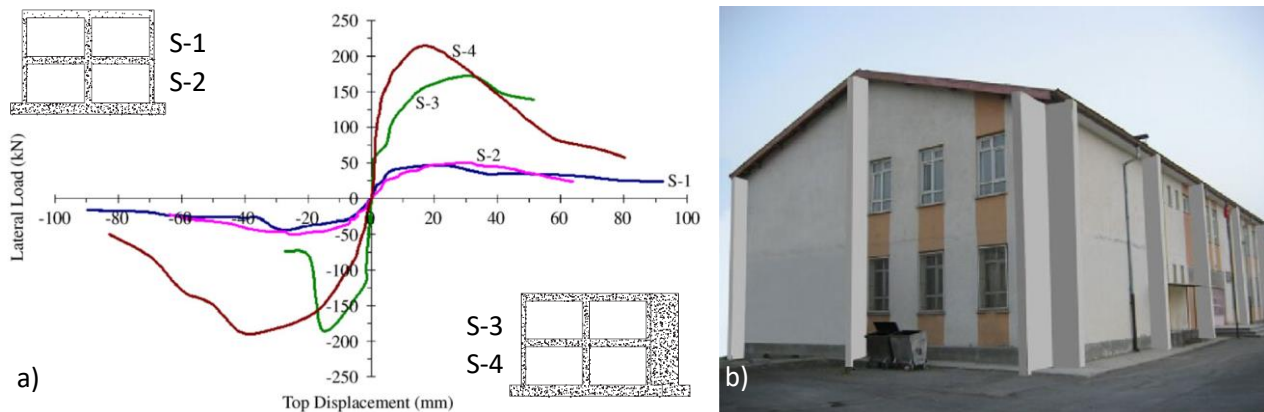

Figure 46 – a) Load-displacement curves of each specimen; b) Rendered image of a typical school building in Turkey, strengthened with external RC shear walls – Source: [46]

Lateral load-displacement curves were extrapolated from the tests (Figure 46a). These curves show that the capacity values of the bare RC frames were 45.88 kN (first test sample) and 50.57 kN (second test sample), while the third and fourth strengthened samples reached a maximum load of 172.42 kN and 211.89 kN respectively. The capacity increased by 3.76 for the frame system whose longitudinal column reinforcement ratio is 0.013 (S-1 and S-3), and by 4.19 for the specimen with a longitudinal column reinforcement ratio of 0.023 (S-2 and S-4). In addition, they reported during the tests that no cracks or separations were observed in the joint obtained through the anchors between the frame system and the shear wall (including the foundation), and no significant deep cracks occurred in the existing frame system, indicating that this type of intervention may not require additional repair or retrofit in the other frame-components and concluding that external RC shear walls can improve the strength and stiffness of the system with low costs and a practical

construction process. Using the same strategy, further experiments and results were presented in [106], confirming the results of the previous investigations, arranging the axial loads in the columns in two different ways to cause tensile and compressive failure and comparing the results with pushover analyses obtained with finite element modelling (FEM). Increased values of lateral load-bearing capacity between 304-404% were confirmed and no substantial cracks or damages were recorded in the frame elements. The strengthened frames were loaded up to 5% of the drift ratio, showing a monolithic behaviour until 2% without separation or slippage of the dowels. A decrease in lateral bearing capacity was then recorded after approximate 2% of upper displacement ratio due to debonding of the anchor reinforcement as a result of insufficient lap splice length at the foundation-shear wall joint [106]. Final remarks were spent towards practicability due to the possibility of having the construction site concentrated on the exterior side, the post-occupancy assessment indicating the possibility of maintaining the use of the building, the consequent reduction in costs and the environmental effects affecting the building façades, changing them, and causing potential issues for buildings that do not have large spaces around the perimeter.

In [47], RC shear walls are installed parallel to the outer sides of the building, demonstrating a significant improvement in the capacity and stiffness of the bare RC frame. Furthermore, in this contribution, imposed cyclic lateral loads simulating seismic loads were applied. As shown in Table 19, the bearing capacity of the strengthened solution was three times that of the bare frame, recording only minor cracks between the new and existing elements after the 1% drift, but no loss in bearing capacity. During the subsequent cycles, the shear capacity of the walls decreased due to the failure of the longitudinal anchorage bars with consequent creep of the underside of the walls. Therefore, additional shear reinforcement was indicated. A response modification factor (R) was also given as a ratio of the top-displacement at the drop in shear capacity (23 mm) to the yield strength (4-5 mm) of 4 to 5.



Table 19 – Comparison of experimental and analytical loads at various drift levels – Source: [47]

Model	Comparison point	Experimental load (kN)	Analytical load (kN)
Reference model	Maximum Load	68.10	66.30
	At 0.5% drift	67.95	66.20
	At 1% drift	66.75	66.30
	At 2% drift	-	47.30
Strengthened model	Maximum Load	206.60	184.50
	At 0.5% drift	197.20	184.40
	At 1% drift	202.95	168.80
	At 2% drift	130.75	123.70

Figure 47 – Photo of the damaged strengthened specimen after the test – Source: [47]

In the conclusions of the contribution, addressing possible implementations, it was pointed out that in case of asymmetrical structures, an appropriate arrangement of the new shear walls should be studied, an adequate connection should be provided to avoid dowels failure that could compromise performances, and designers should consider the possibility of a significant decrease in stiffness and capacity of the damaged existing elements as well as the consequent additional strengthening works. Figure 48 shows the anchorage bars provided between the new shear walls and the existing frame in the case of shear walls perpendicular to the façade (Figure 48a) [106] and of shear walls parallel to it (Figure 48b) [47].

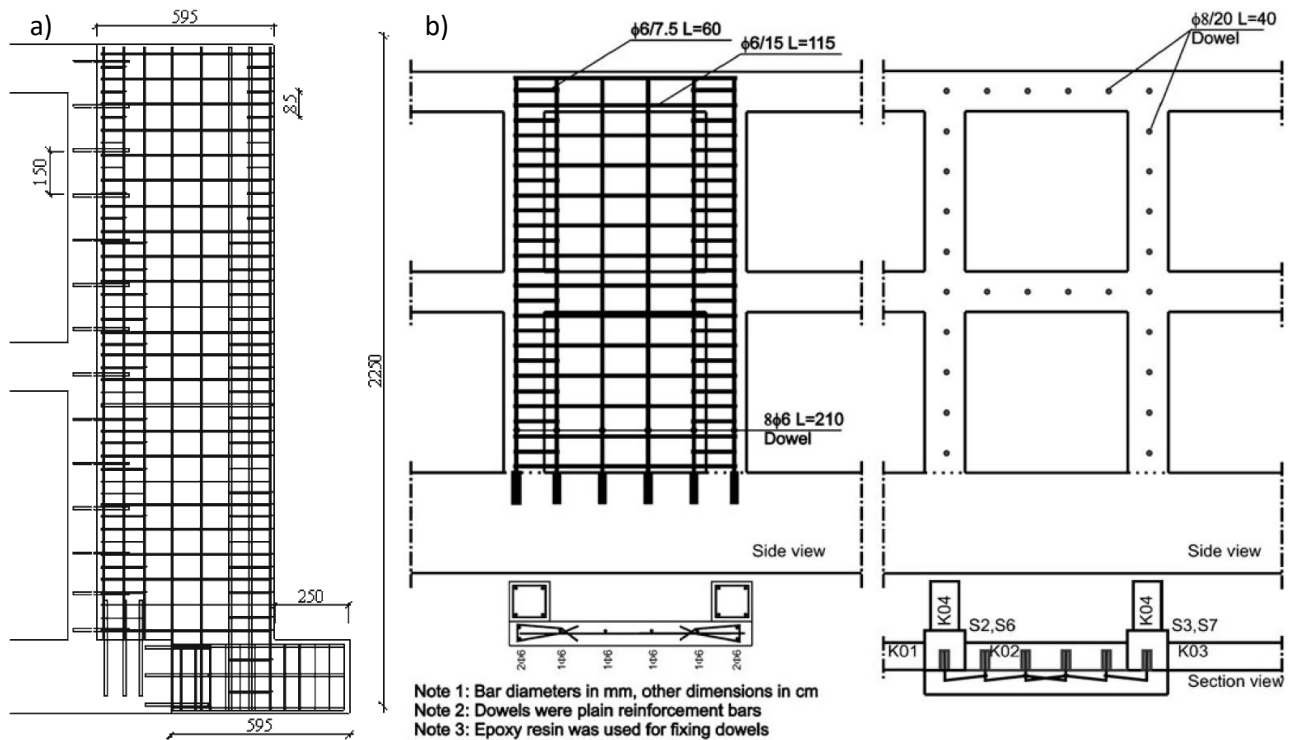

Figure 48 – Reinforcement bars and anchorages provided in the new shear walls and between the two structures; a) shear wall perpendicular to the façade; b) shear wall parallel to the façade – Source: [47, 106]

4.2. Steel frames

The use of steel frames and especially bracing for the retrofit of existing RC seismically inadequate structures has been widely studied in literature and often in practice. However, many references and examples refer to configurations parallel to façade that are relevant as current state of the research, but distinguishable from solutions perpendicular to the façade that could allow possible extensions.

Citing only a couple of examples from the early 1990s, in [107] and [108] diagonal steel bracings were reported in practical experiences and experimentally investigated in their behaviour. M. Badoux and J. O. Jirsa report examples of good practice available in the scenario of that time [107], such as:

- bracing of the Japanese school after the 1978 Miyagi-ken Oki earthquake (Figure 49a). The purpose of the bracing system was to compensate for the loss of lateral strength and stiffness associated with the damage to the column. While the columns and beams of the frame constitute vertical and horizontal elements of the truss, the bracing was detailed to provide energy dissipation under inelastic cyclic lateral loading;
- the seismic retrofitting of a 12-storeys RC building after a 1980 earthquake in Mexico City (Figure 49b). In this case, bracing was installed on the perimeter frames in the weak (short) direction of the building. The slabs were reinforced to transfer shear to the new stiff perimeter frames and new foundations were strengthened with steel piles. The project was completed in 10 months with minimal disruption to the users and at a construction cost of approximately 20% of the building's replacement, and unlike many surrounding buildings, the strengthened structure performed well in the 1985 earthquake;
- the seismic retrofitting of the Zaragoza Hospital in Mexico City as a preventive measure following the 1985 earthquake (Figure 49c). Prefabricated steel bracing was inserted within the RC frame spans on the perimeter to increase strength and stiffness.

Badoux and Jirsa recognised again the advantages of these techniques such as minimised disruption, reduced costs, fast erection procedure and a relatively small increase in mass, associated with the retrofitting

compared to internal or external RC shear walls, resulting in a reduction in new foundations. On the other hand, also considering the maintenance of the structure together with the construction costs may be less convenient, and in some cases inappropriate due to the impact on the aesthetics of the building.

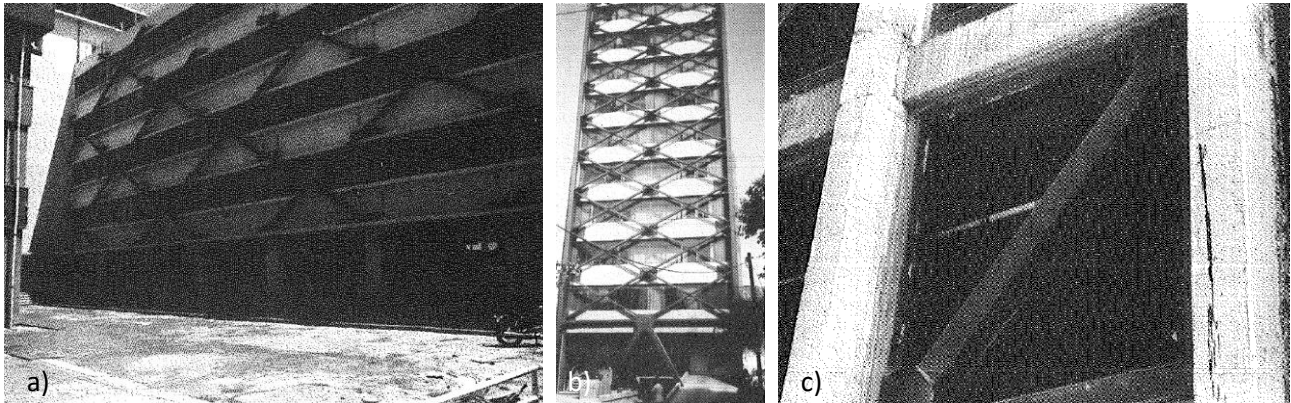

Figure 49 – a) School building in Sendai, Japan; b) RC building in Mexico City braced prior to 1985 earthquake; c) undamaged hospital building in Mexico City braced following 1985 earthquake – Source: [107]

They proceeded by highlighting the possible objectives that can be achieved with steel bracing, ranging from drift control (serviceability limit state) to collapse prevention (ultimate limit state) by identifying a design flow-chart for steel bracing that is highly dependent on the analysis and performance of the specific existing building, the retrofit scheme with its arrangement (they introduced examples of bracing configurations) and the consequent effects on the building performance. After performing an analytical study to understand the behaviour of braced frames under cyclic lateral loading and focusing on frames with short and weak columns, they concluded by stating that the bracing system should be designed for elastic response but detailed for ductile behaviour. Thus, avoiding inelastic buckling that could compromise the good hysteretic ductility of the steel elements.

T.D. Bush et al. experimentally investigated a strengthening technique to improving the seismic behaviour of a non-ductile RC frame [108]. They proposed an X-shaped steel bracing system attached to the outside of a RC frame, using epoxy resin grouted dowels. A two-thirds scale sample of the RC frame, consisting of two bays and three levels (Figure 50a) was subjected to statically applied cyclic lateral loading with and without steel bracing.

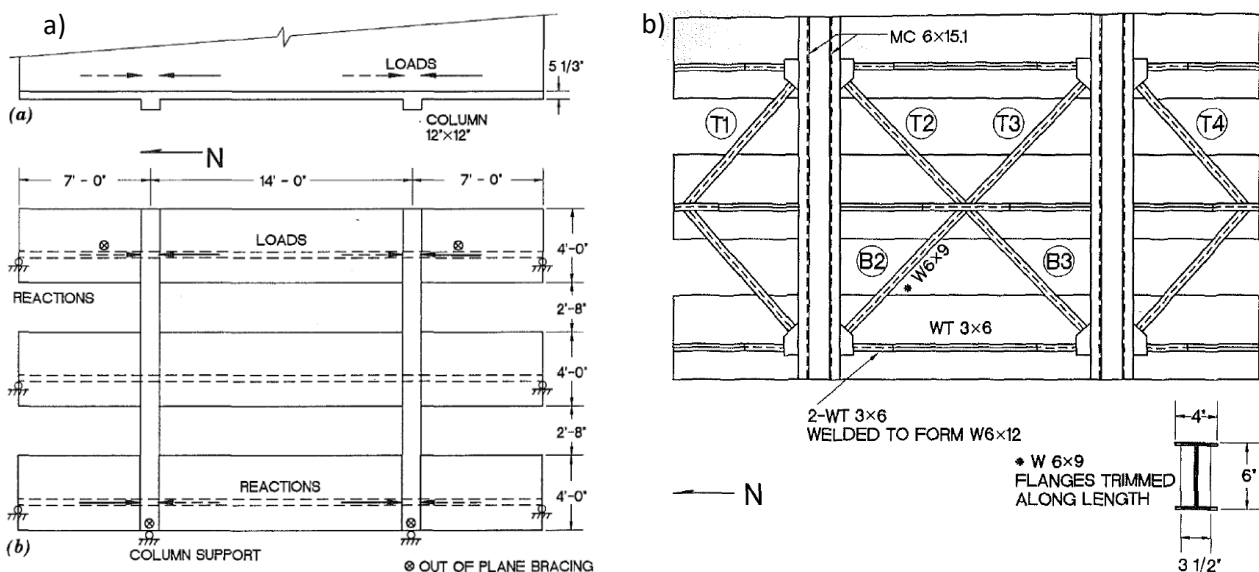

Figure 50 – a) Scheme of the two-thirds-scale frame specimen, above the plan and below the elevation; b) Scheme of the bracing system – Source: [108]

The results of the experimental investigations showed that:

- the maximum applied load was approximately 6 times the calculated failure capacity of the original frame, while the initial stiffness of the braced frame (before cracking) was 1.5 times that of the original uncracked frame;
- the ultimate capacity of the system was governed by the instability of the upper level braces, as indicated also by [107], and by the failures of the brace welds and the column (to shear). These failures did not large drifts to be achieved during the test due to a non-uniform distribution of inter-storey drifts, indicating that the details of the connections and buckling behaviour should be carefully examined;
- the percentage of lateral shear carried by the braces remained at 60-70% until the brace became unstable (buckling), with the columns carrying the remaining loads. The lateral capacity of the columns was increased by the vertical steel profiles fixed to their sides, by at least 50%;
- the connection through dowels performed well, with no shear failure or bearing problems of the steel elements.

Remaining parallel to façades, steel bracing could also be inserted within the spans of RC frames. The work of M. R. Maheri et al. [52] deserves further space in this chapter as it mentions several important response and design parameters, such as load capacity, stiffness, toughness, ductility and performance factor, in relation to pushover tests conducted on scaled models of ductile unit frames (Figure 51a), strengthened by X and knee steel bracing (Figure 51b and 52a, respectively).

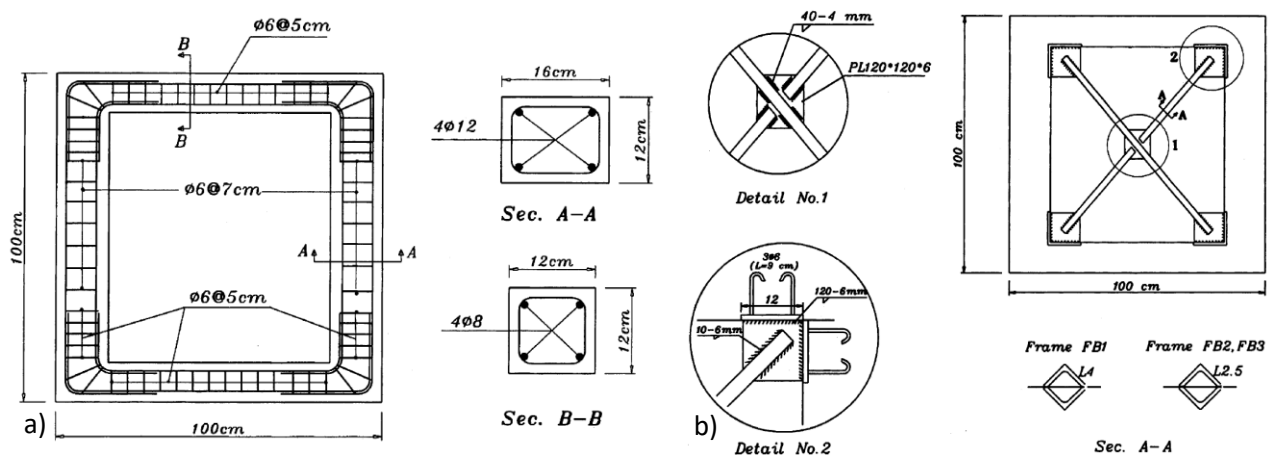

Figure 51 – a) Dimensions and reinforcement detail of the RC-frame specimen; b) details of the X-bracing system and its connection to the RC frame

Six frame samples were built and tested. Two identical unbraced RC frames (F1 and F2), two samples with X-bracing (FB1 and FB2) and two with knee-bracing (FK1 and FK2). The load capacity of the RC frame increased by 2.5 and 3.5 times with knee and X bracing, respectively, indicating a higher efficiency of X-bracing towards capacity, stiffness, and displacement reduction. The load capacity values for the global systems were shown to represent the sum of the capacities of the individual systems (bare frame or bracing). With regards to the initial stiffness (up to the formation of the first plastic hinge) of the system, an increase of 1.46 and 1.40 times was recorded for the X- and knee-bracing respectively (Figure 52b). Furthermore, they proceeded defining and indicating for each specimen the ductility (μ) as the ratio of the pushover displacement capacity (Δ_{max}) and the displacement relative to the yield point of the idealised elastic-perfectly plastic response curve (Δ_y); the ductility reduction factor (R_μ), specified as the ratio between the design elastic force (V_e) and the yield strength level (V_y) and reflecting the energy dissipation capacity of the system; the overstrength factor (R_s) which represents the reserve strength that exists between the idealised structural yield (V_y) and the first significant yield level (V_s); and the total force reduction factor (or performance factor, R) calculated as $R = R_\mu \cdot R_s$ (Table 20). The results shown in Table 20 [52] indicate that when a ductile RC frame is braced, in

return for the increase in strength and stiffness, the ductility, overstrength and performance factor are reduced. These results indicate that the insertion of bracing within an existing ductile RC frame is more suitable for a strength-based design and, especially X-braced frames, make this system unfavourable for a ductile design. On the other hand, knee-bracing is also suitable for ductile designs and can therefore be used to design for both the damage limitation and near collapse performance level.

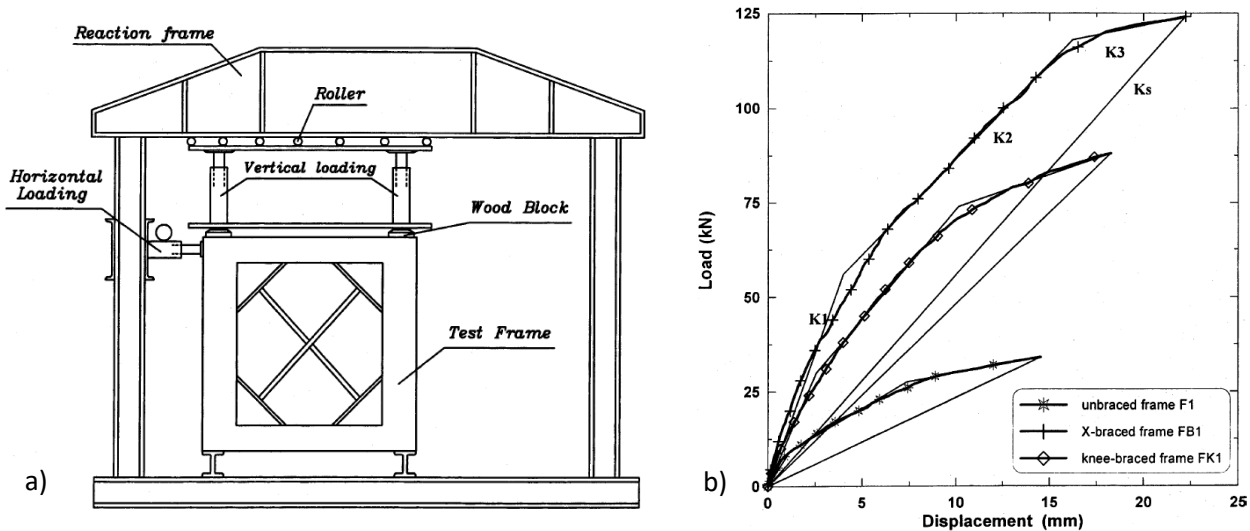

Figure 52 – a) Pushover test setup of the RC frame with knee-bracing system; b) capacity curves and relative stiffness of the tested frames – Source: [52]

Table 20 – Ductility and performance factor parameters of the test frames calculated with a displacement capacity (Δ_{max}) of 10 mm – Source: [52]

Frame	Δ_y (mm)	Δ_{max} (mm)	μ	V_s (kN)	V_y (kN)	V_e (kN)	R_μ	R_s	R
F1	2.78	10.0	3.60	9.5	22.0	79.1	3.60	2.31	8.3
F2	2.65	10.0	3.77	10.0	21.0	79.5	3.77	2.10	7.9
FB1	6.41	10.0	1.56	60.0	74.0	115.4	1.56	1.23	1.9
FB2	6.45	10.0	1.55	59.5	75.0	116.2	1.55	1.26	1.9
FK1	5.21	10.0	1.92	28.0	57.0	109.4	1.92	2.04	3.9
FK2	4.10	10.0	2.44	27.5	46.0	112.2	2.44	1.68	4.1

Another noteworthy contribution is that of T. Görgülü et al. [54]. They observed the seismic performance improvement obtained on existing RC structures by means of external steel shear walls. Two experiments were conducted for this purpose, subjecting two identical two-storey, one-third scale RC models (with and without external steel shear walls) to imposed cyclic incremental lateral loads. The moment-resisting RC frames were designed and constructed to represent the deficient existing structures commonly encountered. On one of the two specimens, the external steel shear wall system was applied (Figure 53b). The strengthening system consists of reverse V-braced frames with steel profiles connected together by bolts to enhance a prefabricated production (Figure 53a). The connections between the two structures play an important role in the effectiveness of the system as they must guarantee the transfer of the loads to the new shear walls. In particular, the connection provides steel plates welded to the profiles of the new structure. Holes were then drilled and cleaned (with dry oil-free air) in the RC columns in the vicinity of the steel plates, in order to fix the dowel bars with epoxy resin. During the erection of the system, the nuts were tightened after the epoxy gained strength (Figure 53c). As results of the experiments:

- the ultimate drift ratios were 1.72% and 2.3% for the bare frame and the strengthened system, respectively, with a tendency to reduce more the first floor displacements;
- the maximum base shear capacities were 67.35 kN for the bare frame and 167.24 kN for the strengthened specimen, with a 248% jump (Figure 53d);

- the initial stiffness was measured at 25.82 kN/mm for the bare frame, with an increase of 160% (41.28 kN/mm) for the strengthened solution;
- the predominance of the sliding shear failure mode over the bending behaviour occurred as horizontal cracks formed at the lower ends of the columns along the construction joints during the tests;
- bracing elements were damaged at a storey drift ratio of around 1.0% at the squashed end near the connection due to buckling, confirming the importance of connections in steel strengthening systems;
- no damage was observed to the anchorages, which successfully transferred the loads between the two structures during the experiments.

Thus, concluding by underlining the typical advantages of strengthening strategies provided outside the existing building (disruption, costs, and assembly procedures).

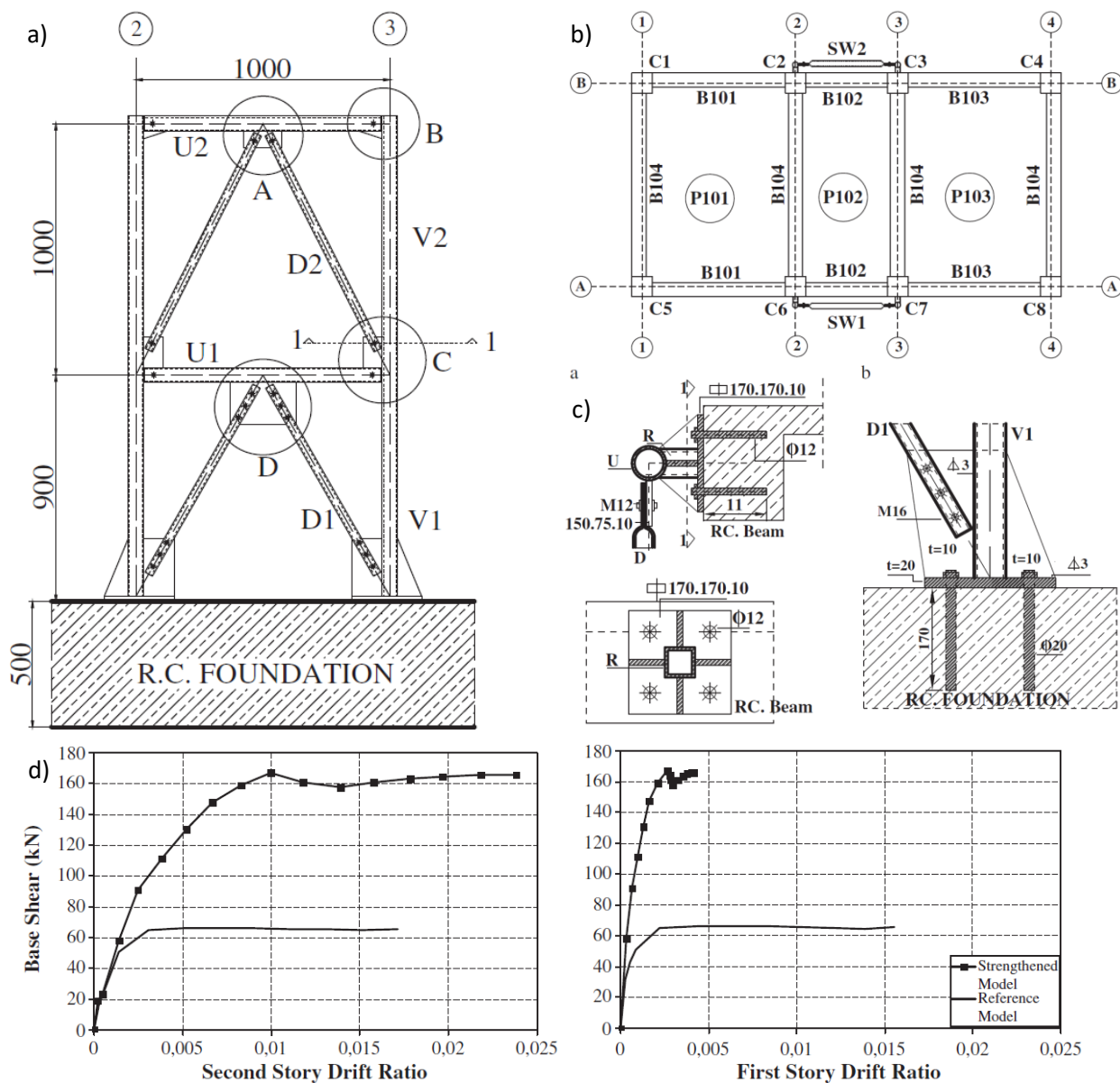

Figure 53 – a) Façade view of the steel shear wall; b) plan of the strengthened RC moment-resisting frame; c) details of the connection between the steel shear walls and the RC frame through dowels chemically fixed in the columns; d) base shear force-storey drift ratio of the RC bare frame (reference model) and the strengthened structure – Source: [54]

Among the few examples of three-dimensional external steel structure, the retrofitting of the office building of the Magneti Marelli Spa company in Crevalcore (Italy) by Teleios Srl [109] is a recent practical example

(Figure 54a, b and c). After the earthquakes occurred on 20 and 29 May 2012 in Emilia Romagna (Italy), several damages were reported on this building, such as structural damages in the two stairwells, cracks in the external infills and more than 70% of the internal partitions and cracks in some RC columns on the first floor. The building has a longitudinal development, the RC structural frames are provided only in transverse direction and the floors are flexible (not able to transfer shear forces), with a consequent risk of domino effect collapse of the RC frames (averted by the fact that the earthquake input directions were mainly transverse to the longitudinal development, in the plane of the frames). After an accurate analysis of the vulnerability of the building and a dynamic characterisation of the ground, the design studio proceeded by assigning only the static function to the existing RC members and relying on a steel exoskeleton for the horizontal actions. The latter consists of braced steel frames connected to the RC frames, to a stiffening system of the existing floors (by means of horizontal steel truss inside the building) and based on valved micro-piles. The design structure was therefore built to withstand 100% of the design seismic actions, as defined by the Italian regulations [110].



Figure 54 – a) Photo of the building before the intervention; b) photo of the RC bearing structure and realisation of the Mesnager hinges; c) photo of the building after the renovation – Source: [109]

In order to avoid the reactive capacity towards seismic forces of the existing structure, the studio modified the degrees of constraint at the base of the RC columns with providing Mesnager-type hinges. This technique implies the cutting of the longitudinal reinforcement bars inside the columns and implies the choice of relying

completely on the new structures for seismic forces. The design of the seismic-resistant structures was therefore carried out based on the damage limitation performance level, assuming as limit displacement, for the existing columns, 0.5% of the height. The structural scheme of the steel frames is such that they can dissipate both as a frame structure (Vierendeel-type mechanism) and as a concentric bracing (active tensioned diagonal). Each truss consists of tubular steel profiles (better behaviour against instabilities induced by strong compressions) already welded together and galvanised in the workshop. On arrival at the construction site, the trusses are positioned and fixed to the foundation anchors. The connections between the existing structure and the trusses are hinged tubular profiles structurally similar to struts or tie rods. Finally, wall bracing on the façades is provided to stabilise the steel truss frames in the longitudinal plane.

Another case with a particular approach is the seismic strengthening of the rural and surveying engineering department of A.U.TH., Thessaloniki, Greece [111]. The existing RC building was constructed in the early 1970s and consists of an underground floor and six identical storeys. The load-bearing structure of the elevations consists of six frames with a span of 18 m, all arranged in one direction and having only the slabs as a transverse connection (Figure 55).

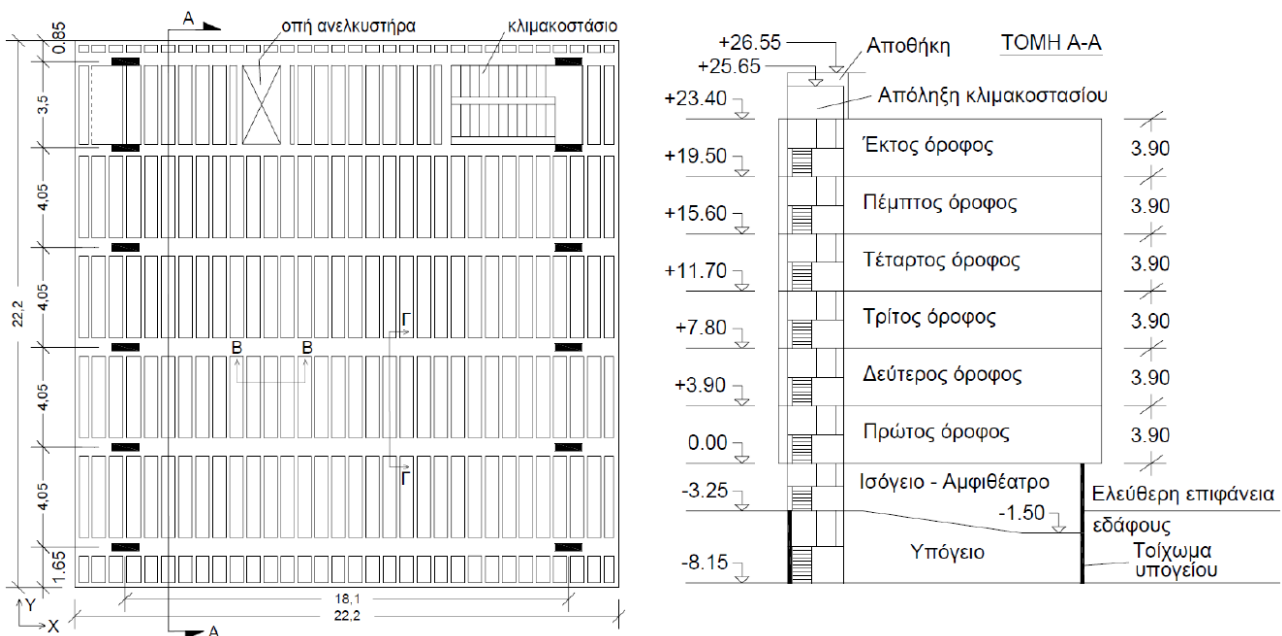

Figure 55 – Typical plan and vertical cross-section of the existing building – Source: [111]

The assessment of the load-bearing capacity of the existing building was carried out on the basis of the requirements of the Greek standards [112], using an acceleration value $a_g = 0.16g$, an importance factor of 1.15, a type B soil and a behaviour factor (q) assumed to be 1.5. The assessment indicated that more than 60% of the structural members were inadequate, 48% of them with demand to capacity (D/C) ratios greater than 1.5, indicating severe and diffuse deficiencies. In contrast, the foundations did not show any problems, probably due to the morphology consisting of a rigid RC box. In order to avoid localised interventions on almost all weak elements, minimise the duration and the costs of the construction, and the interruption of the activities, the choice of strengthening strategy fell on an external steel bracing system. In order to withstand the lateral loads, a steel frame with V-shaped bracing was provided and supported by an additional perimeter foundation. The main steel strengthening frame is provided parallel to the existing structure, but supports additional steel elements that create extensions all around the existing building (Figure 56a). Within these extensions sun-protection devices are provided, together with new external stairs and corridors. In addition, a roof extension of the steel structure creates an additional extra space covered by steel arches. The connection between the two structures consists of a series of steel plates bolted to the existing elements. All the steel frames are based at first floor level and fixed to the new RC perimeter wall which is partially

connected to the existing foundations. Due to the great height of this new wall, orthogonal stiffening walls are provided with regular spacing (corresponding to the base of the steel columns). They concluded with an assessment of the project-state which ensured that it met all the requirements of the modern seismic codes, including some architectural provisions, such as solar-shading, new stairs and corridors, and the extension of the roof (Figure 56b).

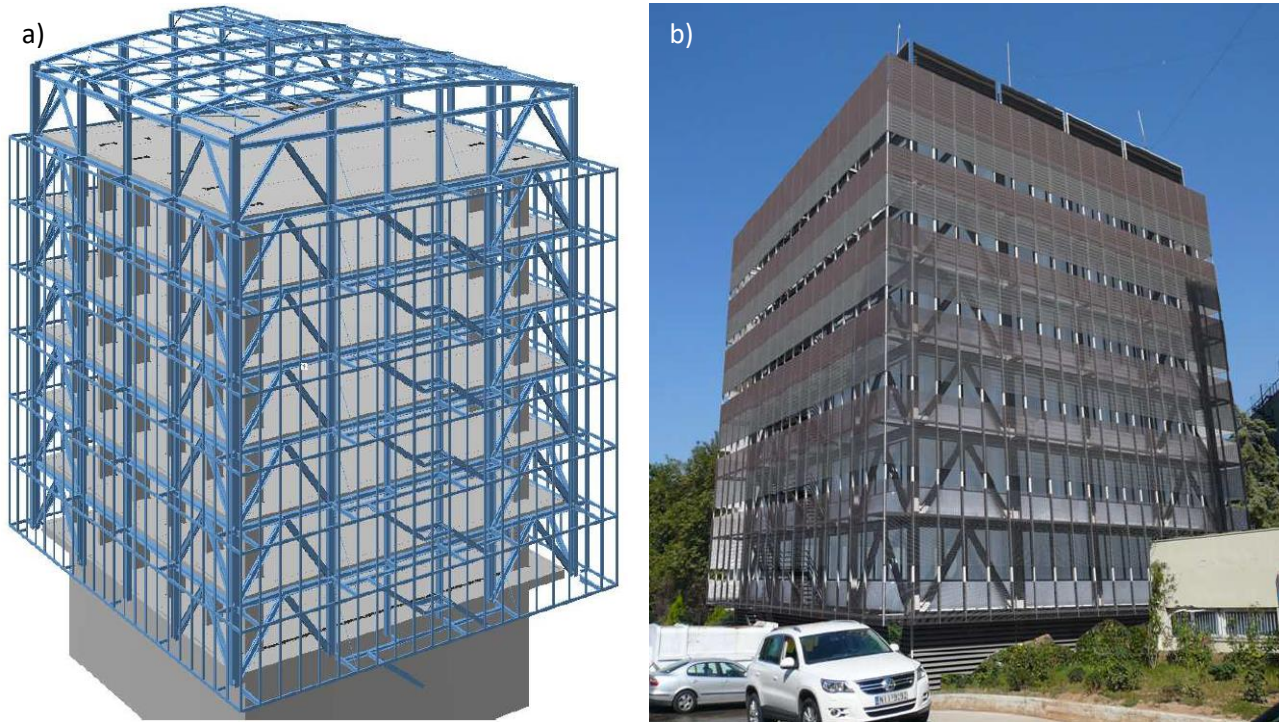

Figure 56 – a) FEM image of the strengthened solution; b) Render of the design solution – Source: [111]

Finally, following the same holistic strategy, Feroldi et al. [113] carried out parametric investigations of an integrated structural and energy system applied as a double skin on existing façades, providing further evidence of the importance of this topic in the European territorial context. In this study, the holistic strategy is presented in order to solve the issues concerning the RC building stocks in favour of a more sustainable renovation strategy compared to the demolition and replacement of buildings (Figure 57a). Focusing on the structural component, Feroldi et al. mentioned the possibility of applying new shear walls parallel or orthogonal to the existing façades, made of RC walls or steel braced frames and the possibility of investigating the collaboration of these systems with dissipating connectors (dampers). As preliminary study, parametric investigations of SDOF systems representing strengthened structures with rigid and dissipative links were presented. Some noteworthy considerations obtained through the analyses SDOF-system are [113]:

- once the ratio of displacements at the elastic limit between bracing and the existing structure is fixed, as the stiffness of the bracing increases, the strength must also necessarily increase, reducing the demand for ductility from the existing structure;
- in the case of an existing building with low strength compared to the design elastic forces, only bracing with high stiffness can keep the existing building in its elastic range;
- in case of an existing building with higher strength, the demand for ductility is lower with a fixed ratio between the stiffness of the bracing and the stiffness of the existing structure;
- once the stiffness of the bracing is fixed, its strength is proportional to the yield displacement and its strength contribution to the global system is higher for weak (deformable) existing structures. For existing strong structures an excessive bracing strength may bring too high additional stresses to the existing structure with a not always favourable reduction of ductility.

By means of a two-dimensional example of a RC moment-resisting structure, characterised by a soft-storey behaviour with high displacement at the first floor, it is then demonstrated that by adding a shear wall with

a stiffness equal to 30% of that of the existing structure, it is possible to linearise the storey drifts along the height and thus, have uniform damage and a higher displacement capacity.

Finally, the feasibility study describing a possible retrofit of a three storeys (above ground) residential building located in Brescia (Italy) is mentioned. Based on the results obtained from the non-linear static analysis, the dimensioning of the new shear walls is carried out by setting as target displacement the elastic limit of the existing structure, equal to a drift of 0.2%. The verification of the effectiveness of the strengthening system is then demonstrated by non-linear dynamic analyses, ensuring that the maximum displacements of the existing structure remain within the elastic limit. The study of the energy-performance of the building allowed to orientate the subsequent design choices [113].

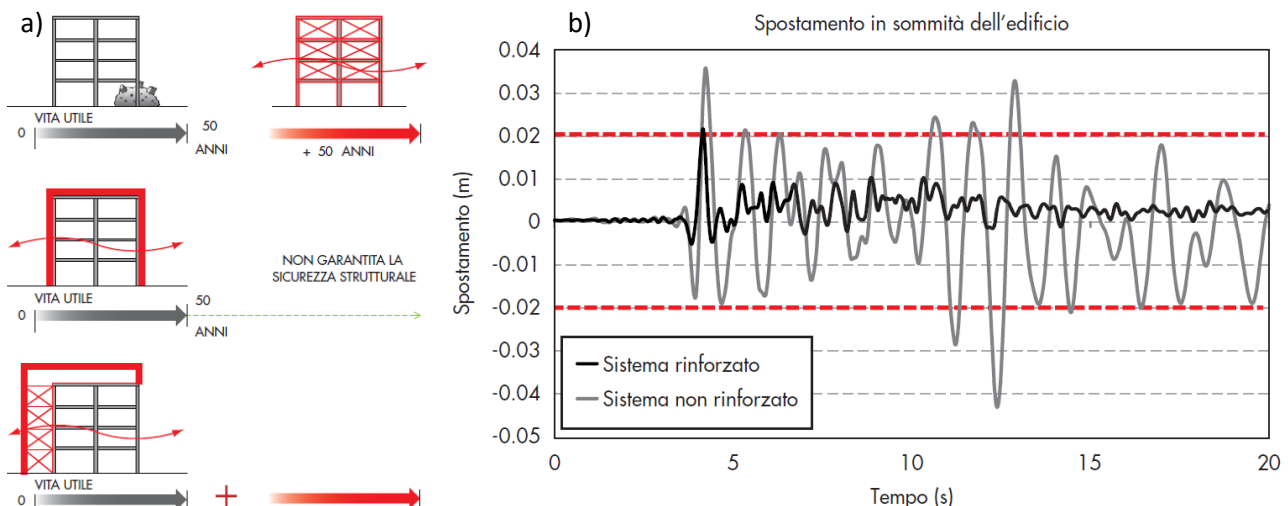

Figure 57 – a) Scheme that represents the advantages of holistic strategies over demolition and replacement and only energy retrofit; only with an integrated system it is possible to reduce the environmental impact caused by new material production and disposal of the demolished components; b) graph showing the reduction in terms of displacements before (grey) and after renovation (black) obtained through non-linear dynamic analysis, the red line represents the elastic limit for the existing structure calculated through pushover analysis – Source: [113]

In these studies, it is possible to find numerous recurrent points in the application of the strategy, such as the tangible increase in the stiffness, strength, and capacity of the structure at the global level usually linked to a reduction in the overall displacements. In some cases this solution leads to a reduction in ductility and a variable evaluation of the effects that depend on every specific case. Specifically, proven the possible to satisfy the standard requirements for the damage limitation performance level (against frequent earthquakes), it is not always immediate to evaluate the behaviour of the global system for the significant damage and near collapse limit states since the elastic limit is always passed and considerations on strengths must always be accompanied by energy dissipation and ductility requirements. For this reason, attempts are often made in practice to separate the bearing-functions of the structures to identify unambiguously (and for safety reasons) the requirements to be fulfilled by existing structure and external additional structure.

4.3. Wooden structures

In the last decades, as consequence of an accelerated drive towards sustainable materials, the rediscovery of wood as a structural material has led to the spread of new engineering wood products and related research (citing only mass timber products, laminated veneer, and strand lumber and cross-laminated timber). In particular, CLT panels are produced to a high degree of prefabrication which allows efficient and safe on-site installation and have been applied globally in many low- and mid-rise buildings typically using platform construction technology [114]. Under seismic loads, CLT shear walls with properly designed connection

systems are able to provide adequate lateral capacity for multi-storey buildings. Despite the lightness of the material which allows to have low values of mass, a higher level of lateral in-plane strength and stiffness can be reached [115]. These qualities make it a product that is easily applicable for extensions [116, 117] or renovation of existing buildings [118-124].

In Slovenia, I. Sustersic and B. Dujic evaluated a new system for combined seismic retrofit and energy efficiency that exploited CLT panels applied parallel to the façades of an existing RC-building [118]. The CLT jacket, depending on the dimensions of the applied panels, proved to be a not invasive intervention that is rigidly connected to the RC frames by means of angular brackets nailed to the wood and fixed with bolts to the concrete slabs. The new external envelope could be integrated with windows, doors, and possibly new technical systems, thus representing a highly prefabricated solution with a fast and practical installation procedure. In addition, CLT panels can be upgraded with various types of insulation involving an integrated energy renovation. The study describes a feasibility study applied on a representative structure designed for vertical loads only and typically characteristic of southern European countries. An elastic modal spectral analysis and a non-linear static analysis were performed before and after the retrofit to evaluate the seismic improvement. Through the use of the N2 method, given in Annex B of the Eurocode 8 [12], a performance-based design is carried out.

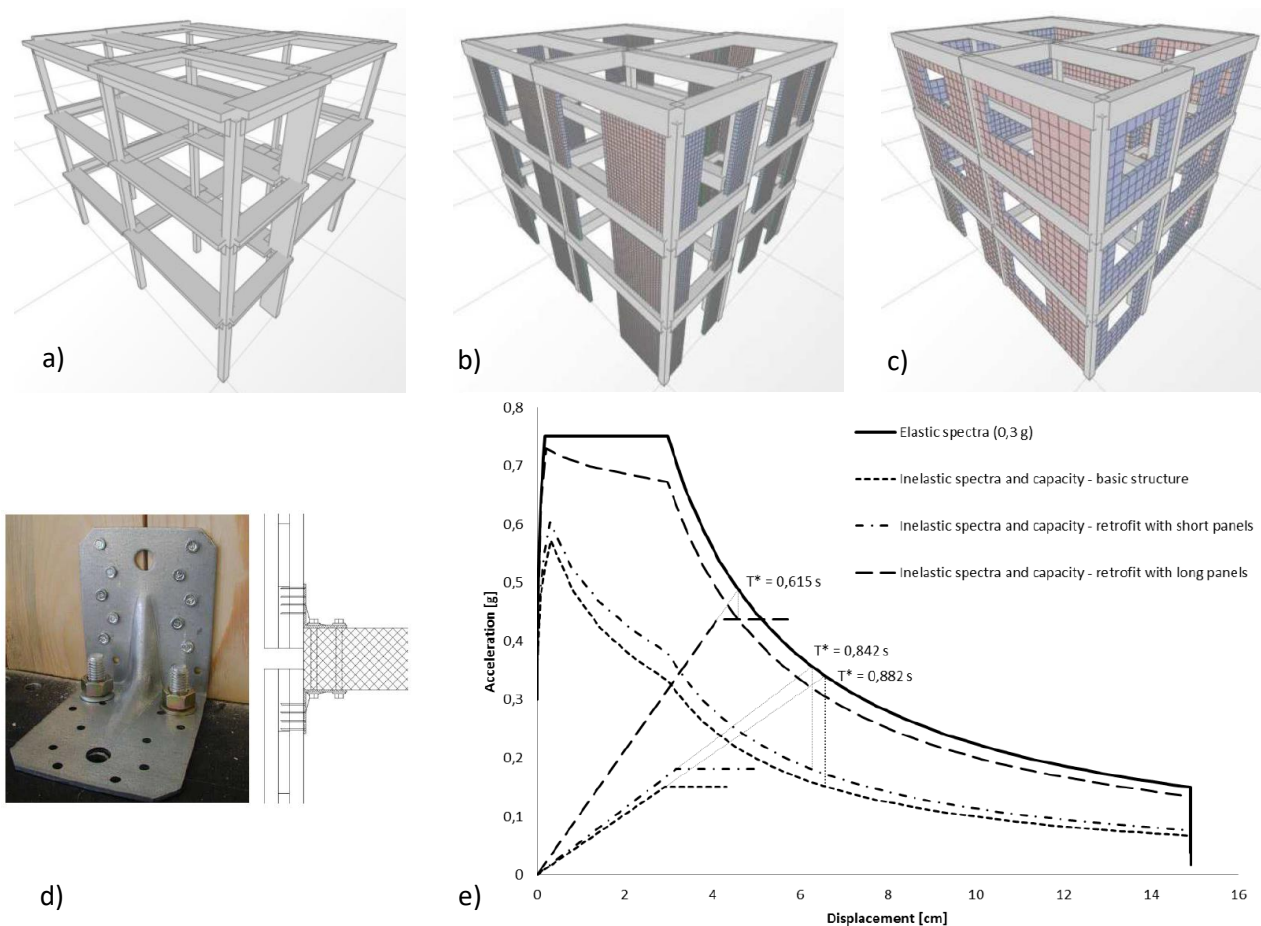

Figure 58 – a) Bare RC moment-resisting frame; b) first project-solution providing short CLT panels; c) second project-solution providing long CLT panels; d) photo and scheme of the connection system; e) acceleration-displacement format with elastic spectrum (for 0.3g), inelastic spectrum and capacity diagrams for the basic and the two project solutions. Period values of the SDOF systems are indicated next to the capacity curves – Source: [118]

The bare RC frame resulted in a capacity, in term of peak ground acceleration (PGA), of 0.197 g. Two options were therefore considered as project-solutions:

- short CLT elements were provided within RC frame spans with an angular bracket (BMF 105) as connector every 30 cm of the panel; resulting in a not particularly stiff structure due to a predominant

bending behaviour of the panels and short leverages of the connections which caused large deformations and a 21% increase in the PGA value (0.239g);

- long CLT panels with longer leverages and more connectors resulted in an increase of almost 90% in allowable ground acceleration (0.374g).

As the system was shown to increase the stiffness and strength of the whole existing RC structure without affecting the overall ductility, stronger (instead of ductile) connections were suggested for further development.

The same authors conducted experiments on the system applied on unreinforced masonry walls and then on a sample of RC moment resisting frames with and without the contribution of masonry infills [119-121]. On the unreinforced masonry sample, the bonding system was studied showing that by using only epoxy glue the initial stiffness increased slightly, the peak strength increased by 34% and the displacement capacity by 25%. However, the use of special steel connectors at the top and the bottom of the wall led to a significant increase in ductility of 100%, showing good potential for unreinforced masonry buildings. This connection consists of a combination of a customised steel bracket and a steel plate; with the former attached to the CLT panel with specific elements providing high strength and stiffness in tension and shear; and the latter attached to the main structure with threaded steel rods drilled into the structure and anchored with an epoxy resin. A series of experimental tests was performed on a shaking table (Figure 59). The same RC sample was tested alone in an elastic state to preserve the structure and determine its behaviour. Two ground motions were used, and sweep tests were performed before and after both earthquakes to measure the natural periods of the bare frame and the strengthened solution (Figure 59 a and c). A shift in the natural frequencies from 2 Hz to 3.7 Hz occurred when the CLT panels were applied to the bare RC frame (only on the ground floor). Eventually, the RC frame was rotated by 180° and a masonry infill was constructed in the direction of the loads (Figure 59b). After measuring the natural periods for both strengthened and bare frame samples, the latter was tested until serious damage occurred. The strengthened structure, shown in Figure 59d, withstood the Landers earthquake (scaled by 0.75g) twice and a further Petrovac earthquake (0.5g peak acceleration) without further damage. The storey drifts of the strengthened structure were reduced by 30% during the same ground motion, even considering that the bare frame already had damage in the infill walls and stating that the strengthening system may preserve the collapse of an already severely damaged building.

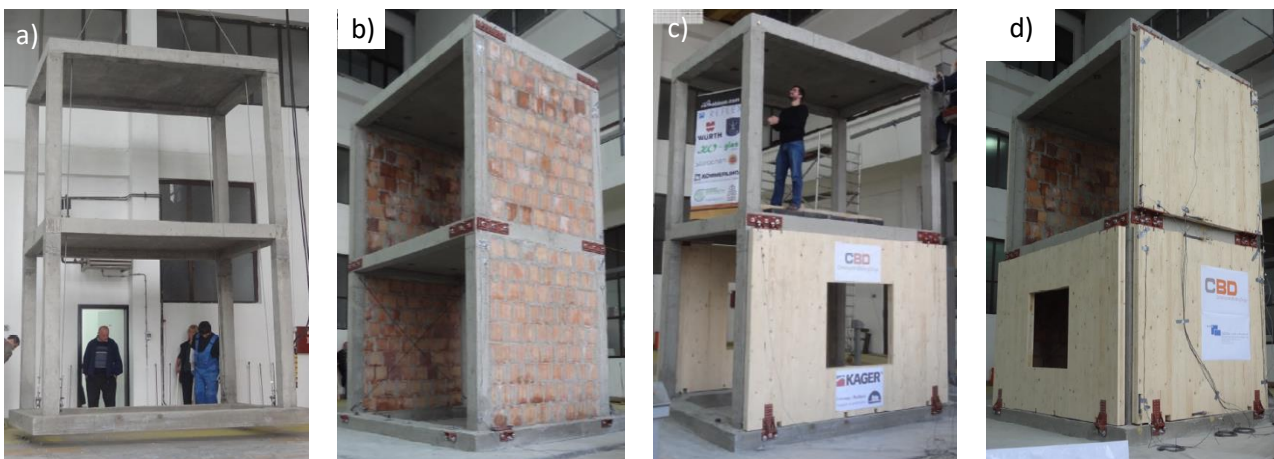

Figure 59 – a) Bare RC moment resisting frame specimen; b) RC moment resisting frame with masonry infills; c) bare RC frame with strengthening CLT panels; d) bare RC frame with masonry infills and strengthening CLT panels – Source: [121]

In this context, from the University of Venice (IUAV), studies were conducted in order to characterise layering configurations applied on CLT-strengthening panels integrated and applied outside or inside the external walls of existing buildings and taking into account minimisation of heat-losses, environmental impacts and intervention costs [122].

Preliminary experimental and numerical study focused on confined (Figure 60a) and unconfined (Figure 60b) CLT panels as new infills (bracing systems) for RC frames [123]. A series of tests (diagonal compression) has been carried out, reproducing the load transmission from RC frame to CLT infill. The results from these tests were then compared with the ones of similar tests on CLT panels with different number of layers and thickness and with unreinforced and reinforced masonry infill. From the diagonal tests, a brittle linear behaviour has been found for all the tested panels, showing the highest maximum load and stiffness values for the confined panels. The characteristic damage was sliding of the boards, only partially limited by the RC frame. The comparison between masonry infills marked the potential of CLT on this purpose, resulting in lower drift value and higher peak load with respect to common masonry walls (Figure 60c).

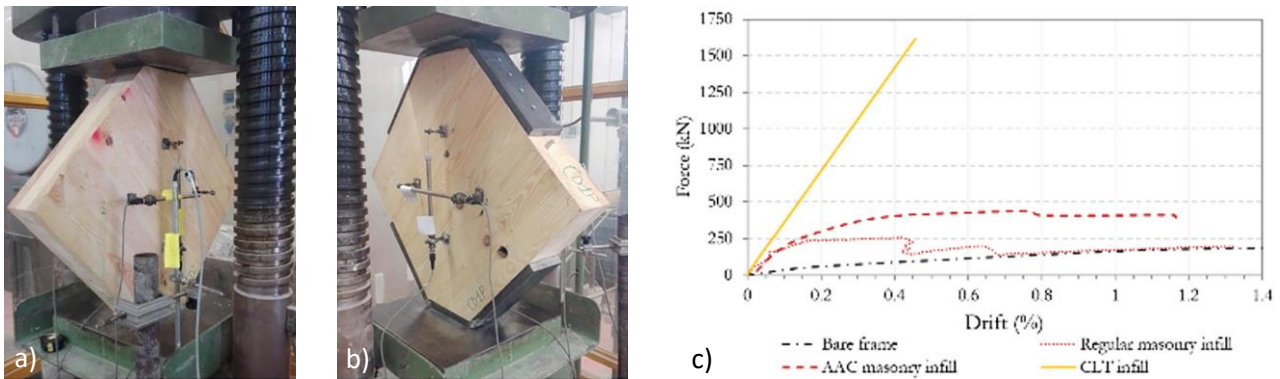

Figure 60 – a) Setup of the diagonal tests for unconfined CLT panel; b) setup for confined CLT panel; c) comparison between experimental and numerical pushover curves related to different infill systems (AAA stands for Autoclaved Aerated Concrete) – Source: [123]

More recently, a similar solution has been proposed in [124] which again involves an outer shell made of CLT panels combined with an insulating layer within additional timber framework (Figure 61a). While simulations on the system have demonstrated the reduction on energy demand, the technical details aimed at developing a pre-assembled system that can be easily installed from the outside with dry components, allowing the reduction of costs and time, embodied energy, and occupants disruption. In particular, the total annual energy demand for heating and cooling has been reduced up to 56% with a further 10% reduction when concurrent thermal insulation is provided on the roof. Regarding the seismic behaviour, the technological system, compared to previous studies, introduced the use of specific connections that provide friction dampers that could improve energy dissipation in addition to stiffness and strength.

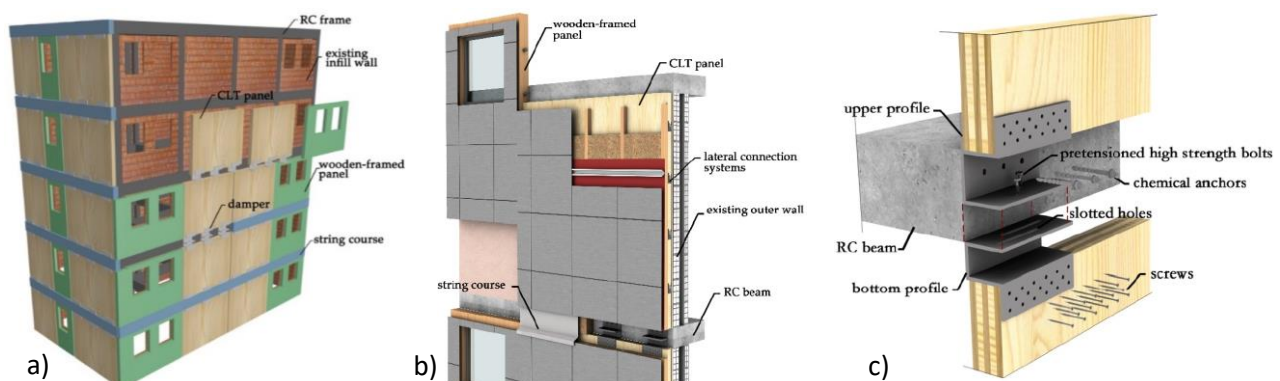

Figure 61 – a) Main components of the retrofitting system; b) three-dimensional view of the external installation of the prefabricated timber panels with ventilated façade system; c) seismic energy dissipating connectors – Source: [124]

The dampers consist of two steel profiles that connect the CLT panels to the RC beam at each level (Figure 61c). While the upper profile is connected to the RC beam by chemically fixed threaded rods, the lower profile has slotted holes where high-strength pre-tensioned bolts pass through and connect the two plates. Shear

forces are transferred by the friction between the contact surfaces, with the number of bolts and pre-tensioning force as variables to adjust the connectors. The objective of the designer is therefore to provide a frictional force to ensure a rigid behaviour of the connection for frequent earthquakes (damage limit state) and to allow sliding for rare and large earthquakes (life safety or near collapse limit states), allowing energy dissipation through friction. CLT panels are combined with pre-assembled non-structural panels made of lightweight timber frames, already providing high-performing windows. Integrated bio-based insulation materials and a desired finishing layer complete the cladding along with a string course that protects the connectors and reduces thermal bridges (Figure 61b).

4.4. Needs and advantages leading to alternative techniques

Taking into consideration what has been introduced so far, considerations can be drawn to proceed to the subsequent presentation of the results of the seismic analyses carried out, in order to guide through the choices that led to the selection of determined strategies and/or materials for the application of the exoskeleton in the various feasibility studies provided by the European project Pro-GET-onE.

New challenges with traditional knowledge

The steel exoskeleton is a consolidated technique in the practice of seismic strengthening of RC structures and is therefore evaluated as first and principal solution for the development of the integrated technology under investigation. Unlike concrete, the use of a steel structure speeds up construction times as it is a dry technology and, if well designed, can allow pre-assembly of the components and consequent rapid installation on site. It also allows a not negligible freedom in terms of structural composition since, based on the behaviour of the existing building, it can adapt the desired stiffness and ductility contribution in order to optimise the improvement performance. However, as reported above, there are few experiences that demonstrate the adoption of steel strengthening bracing or frames arranged perpendicular to the external façade, thus limiting the possible contribution from previous experiences. Moreover, as is evident from the bibliography, it is not immediate to benefit from the contribution of external strengthening structures, since the response always depends on the behaviour of the existing building, which in the cases discussed below will be decisive on the effects of the exoskeleton, sometimes limiting its performance. The case studies analysed depend on the availability of the project consortium partners and are characterised by their own vulnerability analyses, which from a technical point of view as described in Section 2.4.4, should determine the selection of the type of intervention adopted. In this case the application of the exoskeleton is determined by the requirements of the project and not by the technical needs of the existing building.

The first case described in Chapter 5 concerns the student house in Athens (Greece). This, in addition to being the subject of the preliminary architectural design presented in Section 7.1, is the basic RC structure on which the application of the steel exoskeleton will be evaluated in several variants by virtue of an optimisation culminating in the subsequent prototyping.

The possibilities of structural aluminium

The second case concerns a residential building located in Bagnolo in Piano (Italy), where, after an initial application of the steel exoskeleton, a corresponding structural aluminium solution was evaluated through a collaboration with the company ALIVA Srl (partner of Pro-GET-onE), which, as a producer of ventilated façades supported by aluminium substructures, is investigating the possibility of introducing structural aluminium into the seismic renovation market. The application of aluminium alloys as construction material and the possibility to compete with steel are based on some prerequisites, which are related to physical

properties, production process, and technological characteristics. In particular, it is commonly recognised that aluminium alloys can be competitive in those applications where full advantage is taken from the following prerequisites: lightness, corrosion resistance and optimisation of the structural shape [125]. The low specific weight of aluminium alloys, which is 1/3 of steel, allows to:

- simplify the erection phases;
- transport completely prefabricated components;
- reduce the loads transferred to the foundations;
- save energy during assembly and/or in service;
- reduce the physical labour.

The formation of a protective oxide film on the surface avoids corrosion, thus:

- reducing maintenance costs
- and guaranteeing good performance in corrosive environments (marine locations etc.).

Finally, the production process, known as extrusion, allows to:

- improve the geometrical properties of the cross-section by designing shapes that simultaneously minimise weight and maximise structural efficiency;
- obtain rigid shapes without using composite sections, thus avoiding welding or bolting;
- realise prefabricated and plug-and-play connections, thus improving joint details;
- combine different functions of the structural component, thus obtaining a more economical and rational profile.

All these advantages, however, must clash with a lack of performance in terms of stiffness, with a modulus of elasticity (E) of 1/3 that of steel, and an even greater challenge in terms of connections. The latter must be precisely designed to be practical and efficient, with a preference for bolted solutions. In fact, even if welding is possible for aluminium, it is necessary to take into account the heat-affected-zones (HAZ), as defined in Eurocode 9 [126], since they can be associated with major weaknesses for the whole structure with consequent disadvantages in practice, since the design is not always free of errors and may sometimes rely to corrections directly on site.

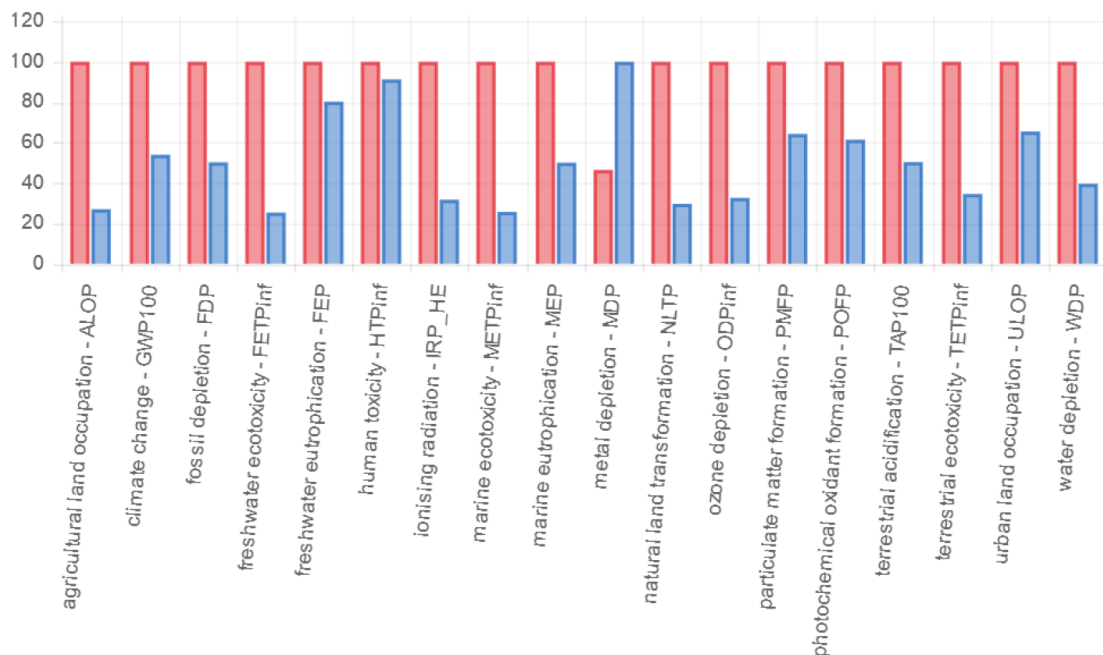

Figure 62 – Normalised results of a relative comparison between aluminium (red) and steel (blue) exoskeleton scenarios for 18 impact categories – Source: [127]

Furthermore, a preliminary life cycle assessment (LCA) is performed from cradle to grave, comparing the aluminium-based structure with the consolidated steel solution [127], showing that the aluminium structure

has a heavier impact in all the analysed categories (see Figure 62) with a relevant difference in the Climate Change category [104].

Advantages of wooden structures

Remaining in the context of LCA and LCC, as introduced in Section 3.3.2, preliminary result of [104, 127] shows the environmental impact expressed for each component designed for the Athens prototype (Figure 63). The technological system developed for the Athens case study was divided into prefabricated components for the renovation of the envelope (windows, walls and floors or extra room, roof and plainwall), new additions (modular façades), new heat pumps (ELFOPack), new ventilation systems (AircareES), photovoltaic panels (PV sunpower), external stairs and strengthening structure (exoskeleton). From the LCA it is estimated that over an analysis period of 50 years, out of a total of about 700 tonnes of CO_{2e} related to the whole renovation, 35% is due to the external steel structure (exoskeleton). Therefore, it appears clear that to further address climate change mitigation and minimise the environmental impact, alternative structural solutions should be investigated.

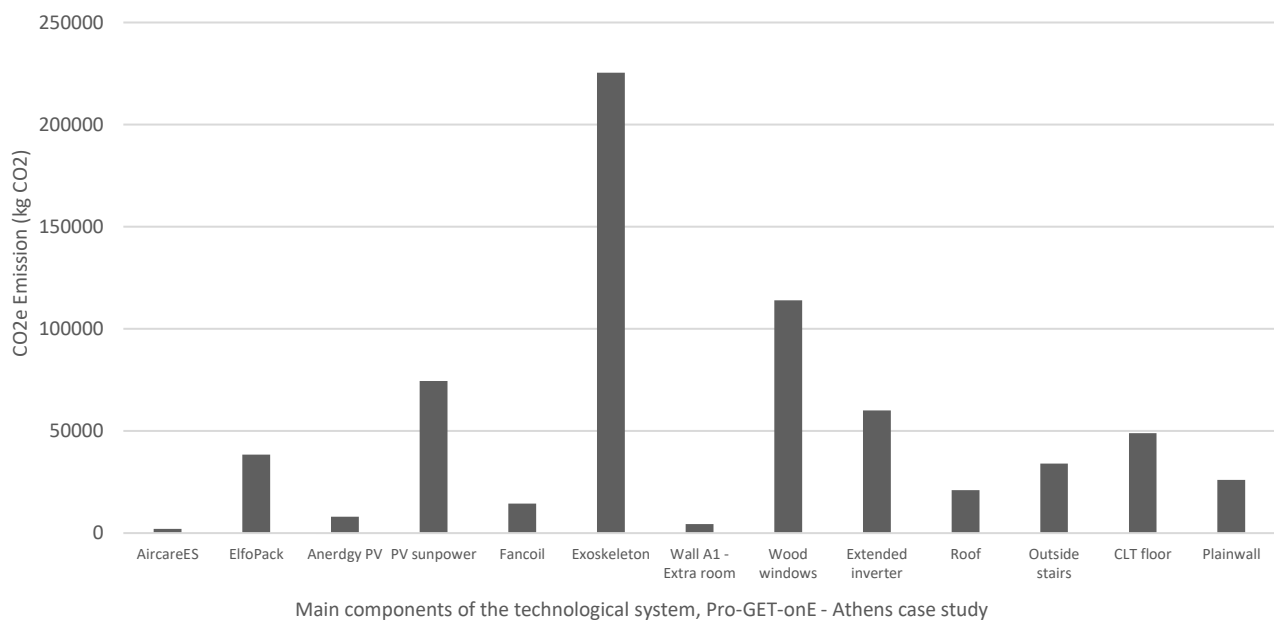

Figure 63 – Impact of the main components of the technological system for an analysis period of 50 years – Source: [104]

For this reason, a homeless-dormitory building located in Brasov (Romania) is addressed as the last feasibility study providing a wooden-based solution as three-dimensional external structure. Through the exploitation of the advantages given by timber constructions, a structural strengthening is presented that provides at the same time a simplified technological detailing and consequently the assembly phase of the components and that constitutes a valid alternative to the consolidated steel exoskeleton with a consequent reduced impact in terms of life cycle assessment compared to the use of other materials.

Further preliminary results from [4] indicate values for a LCC analysis of external strengthening structures as function of the different materials: steel, aluminium or cross-laminated timber (CLT). Considering an economic life of 50 years, a discount rate of 2.75% and an area of structure per housing unit of 20 m², the costs for the structure divided by material are indicated in Table 21 (considering initial cost, operation cost, maintenance cost, replacement, and final disposal cost).

Table 21 – Global and structure-related cost estimations from preliminary results of the Pro-GET-onE consortium – Source: [4]

	Structure costs	Initial cost/m ²	Yearly maintenance cost/m ²	Global cost on 50 years/m ²
Steel structure	€ 3.50/kg	€ 262.50	€ 0.68	€ 283.69
Aluminium structure	€ 8.00/kg	€ 360.00*	€ 0.94	€ 389.29
CLT structure	€ 2'000/m ³	€ 250.00	€ 0.65	€ 270.25

* The maintenance costs are estimated as 0.26% of the initial costs, losing the advantage implied using aluminium over steel

In [4] approximate considerations about the LCA of the strengthening solution were made, this time also considering a CLT structure in the assessment. Including three main impacts (human health, ecosystem quality and resources) two indicators were shown:

- embodied energy (EE), defined as the sum of all the energy required to produce any good or services;
- global warming potential (GWP), defined as a relative measure of how much heat a greenhouse gas traps in the atmosphere and expressed as a factor of carbon dioxide (considered for the phases involving material production).

Table 22 – Estimation of the GWP and EE indicators, comparison between steel, aluminium and timber – Source: [4]

	GWP per unit (kg CO ₂ /kg)	EE per unit (MJ/kg)	Total estimated mass per housing unit (kg)	Total GWP (kg CO ₂)	Total EE (MJ)
Steel structure	1.7	35	1'500	2'500	52'500
Aluminium structure	22	217	900	19'800	195'300
CLT structure	-1.42	7.8	1'246	-1'769.32	9'718.8

Although these preliminary results were carried out before the evaluation reported in Figure 62, they confirm the lower impact of a steel structure compared to aluminium and as the most environmentally friendly solution the CLT-based exoskeleton (with the lowest impact in terms of environment and costs). A thorough case-by-case analysis should be performed to understand the best applicable solutions based on both the accurate life cycle assessment and the seismic performance [4].

The use of wood is accompanied by additional advantages, such as:

- ductility in terms of pre-assembled and customised production, since, unlike other materials, no heavy equipment is needed to cut or adjust components on site;
- speed of construction, guaranteed by the lightweight of the material and the preassembled components;
- mechanical properties, compared to the lightweight of the material, allow good performances to be achieved with optimised design and implying a reduction of activated masses during seismic events;
- energy performance linked to a higher degree of insulation (conductivity values – U) than concrete, steel, or plastic, thanks to its natural cellular structure;
- sound absorption, as its acoustic properties allow for minimal echo in living spaces or offices, and can help to significantly reduce noise levels for greater comfort;
- comfort, as wood has a wide range of aesthetic options with related properties that allow a user-oriented design; furthermore, the emission of volatile organic compounds (VOCs) and carbon dioxide is lower than that of aluminium, steel, concrete, and plastics (not always true for all engineered wood or composite products);

On the other hand, if not design precisely, wooden construction can have significant long-term effects (e.g., mould and mildew) and/or deformations (e.g., swelling, shrinkage). Strength and stiffness, although relevant considering the lightness of the material, sometimes do not allow the desired design objectives to be achieved. Finally, timber structures are characterised by fire risks that must always be addressed during and after the construction.

5. Seismic improvement through the exoskeleton

The Pro-GET-onE strategy (GET-system) aims to combine energy-efficiency with seismic strengthening, providing a system of volumetric extensions integrated with an external structure. These objectives can be achieved by placing the strengthening system outside the existing building and creating three-dimensional exoskeletons around the RC frames. For architectural reasons, bracing parallel to the façade was avoided, allowing the structural performance to be improved only in the plane of new additional shear walls placed perpendicular to the external façades and constituting the new bearing supports for the volumetric additions.

The exoskeleton has always been present as a practice prior to theorisation and the applications remain singularities. Many architectures expressed by the exoskeleton struggle to be typologically recognised as variations on the theme, making each application seem like a new beginning and losing the stratification of knowledge and references that already exist. The exoskeleton is a structural system placed outside the building which, in combination with rigid floors, must provide sufficient stiffness and strength to withstand the horizontal actions. Collaboration with floor diaphragms is critical to the effectiveness of the strategy, as they allow horizontal loads to be transferred to the lateral resisting system positioned around the perimeter, prevent out-of-plane buckling in two dimensional applications and sometimes form part of the external structural system [128]. As introduced in the previous chapter, the new structure can be designed to resist the horizontal seismic actions alone or in cooperation with the existing structure.

This chapter describes three exemplary cases of application of the exoskeleton, characterised by different design solutions, materials, and territorial and typological contexts. The evaluation of the seismic improvements obtained for the existing building with the application of the exoskeleton was carried out using structural analysis software (SAP2000 [129] and ETABS [130]) that complies with the Eurocodes [11, 12, 126, 131-136] or the national standards [112, 137-139] through finite element modelling (FEM). The spatial structure of the existing RC buildings was translated through one- and two-dimensional finite elements (mostly beams or shells) and by configuring both, before and after the intervention, several seismic analyses (specified for each case) were performed to quantify the actual improvement. The study aimed more at an increase in stiffness linked to the application of the external structure to influence the dynamic behaviour, strength, and capacity of existing buildings, than at an increase in damping, possibly achieved in these strategies through the insertion of dissipators in strategic positions. The use of dampers, possibly located in the bracing of the new frames or in the connection between the two buildings, constitute an interesting alternative or implementation to the work carried out so far and is not explored for reasons of time and to limit as much as possible the costs related to the structural aspect of the project. In fact, it is important to underline that the analyses carried out were not always aiming at the complete fulfilment of the seismic demand, but sometimes at the maximum seismic improvement obtainable, considering the requirements imposed by the project: no intervention inside the building, architectural freedom of the façade, maximisation of prefabrication to speed up construction times and minimisation of costs. For each proposed solution a report on the quantity and cost of the material making up the exoskeleton is therefore provided.

In order to get a clearer picture of the type of intervention proposed before going into the results of the structural analysis, it is possible to consult the comprehensive graphical annexes in the appendices. While Appendix A shows the structural drawings, Appendix C shows the architectural drawings with reference to the student house in Athens. To conclude, the graphic drawings representing the wooden solution are shown in Appendix D.

5.1 The Greek case study – towards the prototype

The Greek case study belongs to the National and Kapodistrian University of Athens and is located on the university campus of Zografou, a suburb of Athens (Lat. 37.98, Long. 23.73; Figure 64). The Municipality of

Athens has a population of over 664'000 inhabitants [71] within its administrative boundaries, and a territory of almost 40 km² with elevations ranging from 70 to 388 m. The building that has been assigned for the evaluation and the further application of the prototype is called B-Building FEPA (B'-Κτήριο ΦΕΠΑ in Greek) and is a student dormitory, housing 138 single rooms for students.



Figure 64 – a) and b) Location and three-dimensional view of the Student House in Athens; c) photo of the northwest façade – Source: [140]

Table 23 – Class reference for building – Source: [12]

Class	γ_I	Use of building
I	0.8	Buildings of minor importance for public safety, e.g., agricultural buildings, etc.
II	1.0	Ordinary buildings, not belonging in the other categories.
III	1.2	Buildings whose seismic resistance is of importance, in view of the consequences associated with a collapse, e.g., schools, assembly halls, etc.
IV	1.4	Buildings whose integrity during earthquakes is of vital importance for civil protection, e.g., hospitals, fire stations, power plants, etc.

Each earthquake-prone country is divided into zones according to local hazard. Figure 65 shows the seismic classification of Greece in terms of acceleration from the EAK2000 [112]. The seismic ground motion is described by the a_{gR} acceleration which denotes the peak ground acceleration (PGA) of reference on a type A soil. Athens is located in zone I with a reference value acceleration of 0.16 g.

Depending on the possible consequences of ground motions, buildings are classified into four classes. Each class has an importance factor (γ) between 0.80 and 1.40 (Table 23 [12]). For this case study class III was selected due to the building's function associated with the university and the constant presence of students.

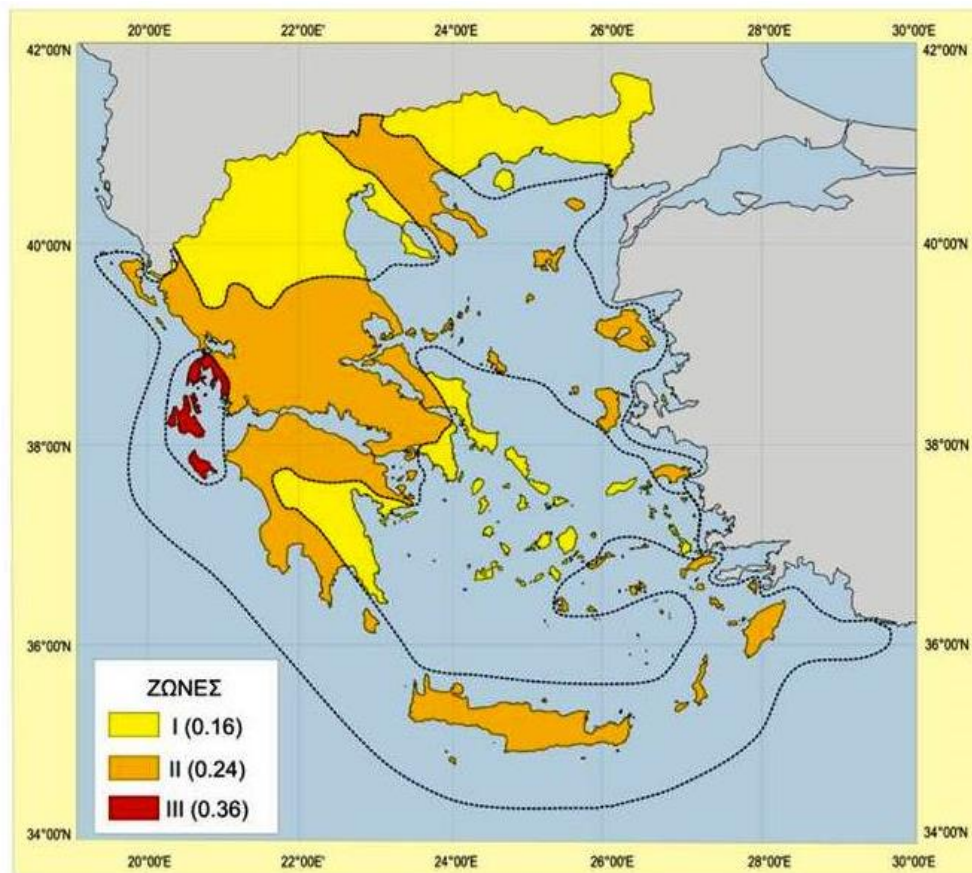

Figure 65 – Seismic risk zones of Greece expressed in ground acceleration with 10% probability of exceedance in 50 years according to the seismological data – Source: [112]

The building was designed according to the structural regulations of 1945, with live loads of 200 kg/m² for the rooms and 500 kg/m² for the corridors and therefore, comparable to the actual requirements of the Eurocode [135]. On the other hand, the seismic design of the building was carried out on the basis of a design seismic acceleration of 0.06 g, whereas the current regulation requires a seismic acceleration of 0.16 g [141]. Work on the building began in 1986, and once completed it has remained in continuous operation. The building consists of a 4-storeys dormitory and a semi-basement. Figure 66 shows the vertical cross-sections and an axonometric view of the initial state of the case study; the net height of each storey is 2.73 m while at the basement floor it is 3.67 m. The main entrance is oriented to the north-west side.

The building has a rectangular and regular shape. The gross floor area of the building is approximately 3'600 m² containing 138 rooms, many of which have a floor area of 9.50 m². The storeys are connected by a central staircase and two lifts. The latter do not reach the basement because of problems related to underground water, which can overflow through the lift shaft, causing damage to the lifts' electrical system. The net conditioned volume of the building is 6'960 m³ [141]. Problems are detected at points along the perimeter, which are related to moisture that may have affected the load-bearing elements locally.



Figure 66 – Drawings of the initial state of the Athens case study; a) longitudinal cross-section; b) transversal cross-section; c) three-dimensional view of the BIM model – Source: [142]

The load-bearing structure of the building is divided into two parts, separated by a seismic joint. The separation is due to the large overall length of the building to limit the individual lengths below 40 m. The two subframes are formed with a similar grid and cross-sectional dimensions apart from the part concerning the RC walls of the stairwell. The surface areas of the two parts per floor are 290 m² and 430 m² for the north (the smaller) and the south part respectively (Figure 67). The structural scheme consists of large columns, arranged in opposite directions along both main directions (longitudinal and transversal development). These columns are 25x125 cm in size for all storeys. It has frames in both directions, continuous in the longitudinal direction and separated from the central corridor in the transversal direction (Section 5.1.1.2). An 18 cm RC slab connects all moment resisting frames together at each floor. On the whole perimeter of the structure there are balconies projecting 1 m along the long side and 1.5 m on the short side, these are made of a 15 cm concrete slab.

Due to the collaboration with the University of Athens and for an optimization of costs incurred for the prototype, the feasibility study of the exoskeleton is focused on the smaller part of the building, separated from the seismic joint (north side). The following considerations and analyses, together with the final structural drawings in the Appendix, only concern this part of the building.

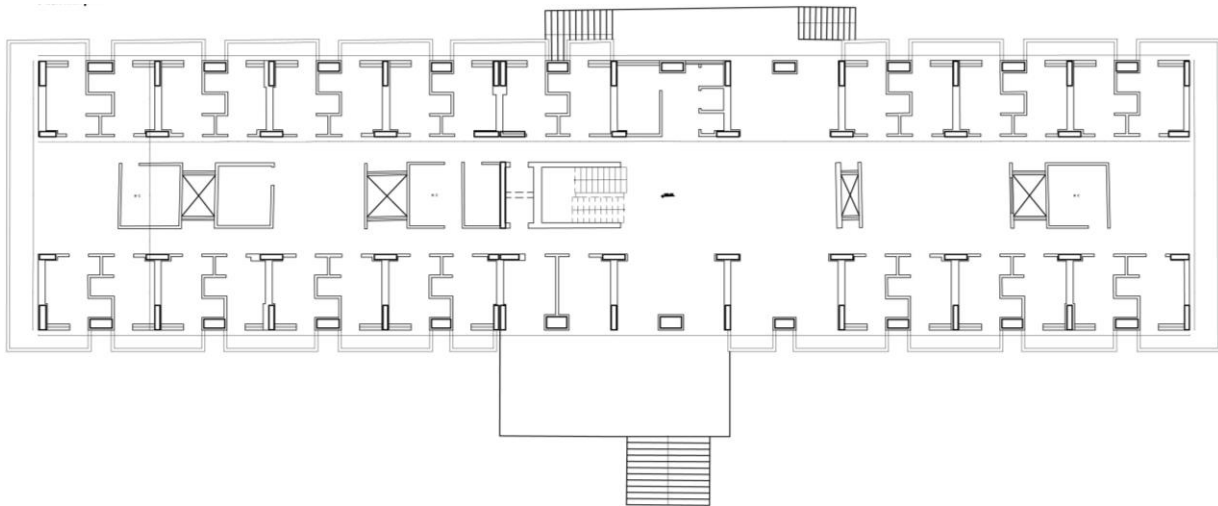

Figure 67 – Typical plan of the Athens case study – Source: [141]

5.1.1 Initial state, before the intervention

The RC moment-resisting frame is particularly stiff due to the size of the vertical elements. However, it is also subjected to equally important loads due to the horizontal RC slabs. Therefore, while having an existing rigid structure which may decrease the effectiveness of the exoskeleton [113], the presence of rigid diaphragms allows a correct exploitation of the strategy.

Before evaluating the different variants of the steel exoskeleton, the seismic vulnerability of the existing structure is identified. The following data are taken from drawings and reports resulting from the structural survey provided by the National and Kapodistrian University of Athens [143].

5.1.1.1 Materials

The concrete and steel mechanical characteristics are derived directly from the structural survey. The latter carried out to obtain an intermediate level of knowledge (LK2) which, according to the indications of Eurocode 8 – Part 3 [11] and the Greek national legislation Kan.epe [139], allows the use of a confidence factor (CF) of 1.2. On the concrete, destructive and non-destructive analyses gave the following results. Concerning the steel reinforcement, the survey evaluated its condition under visual inspection following the removal of some bars distributed on the structure, therefore without tensile tests. The resulting data, used for the analyses are reported below (Tables 24 and 25), for the north part of the building.

Table 24 – Mechanical parameters of the concrete class – Source: [143]

Concrete class	Weight ($\frac{kN}{m^3}$)	$f_{ck}(MPa)$	$f_{cd}(MPa) = \frac{0.85 \cdot f_{ck}}{CF \cdot \gamma_c}$	$E(MPa)$	$G(MPa)$	ν
Derived from the survey	25	20.2	9.54	29'962	16'667	0.2

Table 25 – Mechanical parameters of the steel grade – Source: [143]

Steel grade Rebar	$f_{yk}(MPa)$	$f_u(MPa)$	$f_{yd}(MPa) = \frac{f_{yk}}{CF \cdot \gamma_s}$	$f_{ud}(MPa) = \frac{f_u}{CF \cdot \gamma_s}$	$E(MPa)$	ϵ (%)	ν
S400	400	500	289.86	362.32	210'000	14	0.3

- f_{ck} - characteristic compressive strength of concrete
- f_{cd} - design compressive strength of concrete
- γ_c - partial factor for concrete, used for the linear dynamic analyses
- E - modulus of elasticity

- G - shear modulus
- ν - Poisson coefficient
- f_{yk} - characteristic value of yield strength of steel
- f_u - characteristic value of ultimate strength of steel
- γ_s - partial factor for reinforcement steel, used for the linear dynamic analyses
- f_{yd} - design value of yield strength of steel
- f_{ud} - design value of ultimate strength of steel
- CF - confidence factor

5.1.1.2 Structural scheme and characterisation of the members

Based on the structural drawings, the FEM model was defined by beam elements for RC columns and beams. The floors were considered by placing the loads on a null-area section (G_1 , G_2 and Q_k) and a diaphragm constraint was considered for all the points belonging to the same Z level (vertical axis), due to the rigid behaviour of the 18 cm thick slabs. Two images of the FEM model are shown in Figure 68.

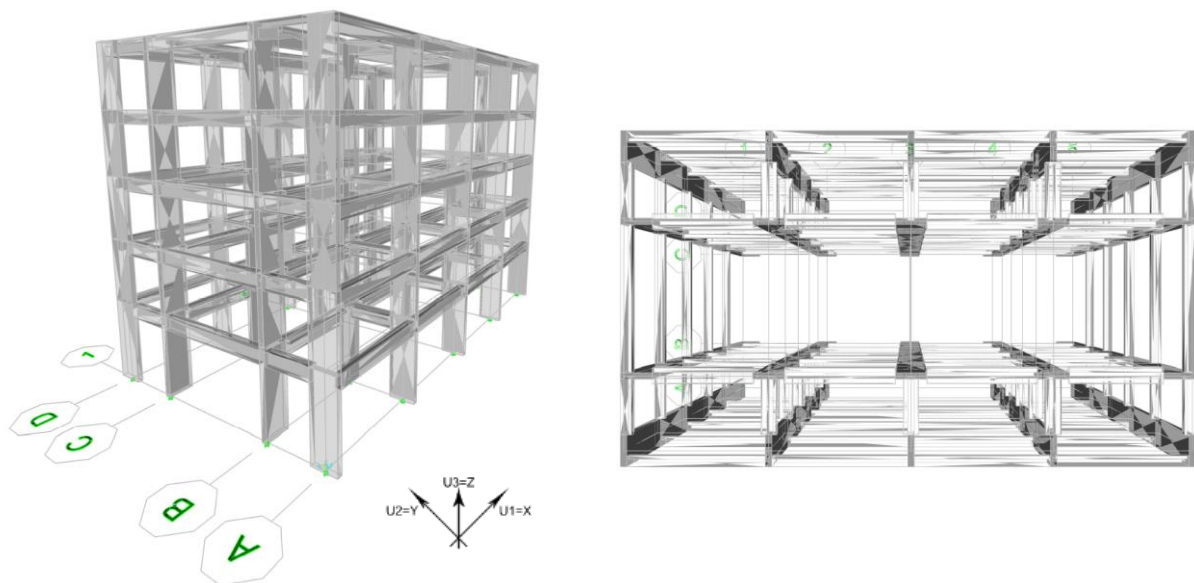

Figure 68 – Panoramic views of the finite element model of the north part of the Athens case study

Two continuous frames, formed by beams and columns, are developed in the longitudinal direction, while five frames in the transverse direction are interrupted by the wide corridor where only the RC slab is present. However, at the ends of the building edge beams form two continuous frames also in the transverse direction. Comparing the information received from the structural survey with the laser scanner survey performed by the University of Bologna the outline geometry of the building was checked, and the structural scheme derived. The bays of the structure in longitudinal direction (X) from north to south are 5.7 m, 5.6 m, 5.6 m, and 5.45 m, while in transverse direction (Y) they measure 2.95 m, 6.05 m, and 2.95 m (Figure 70). The heights of the storeys, reported from floor-to-floor net of architectural stratigraphy are all approximately 3.03 m, apart from the basement and the last storey which measure 3.90 m and 2.98 m (Figure 71).

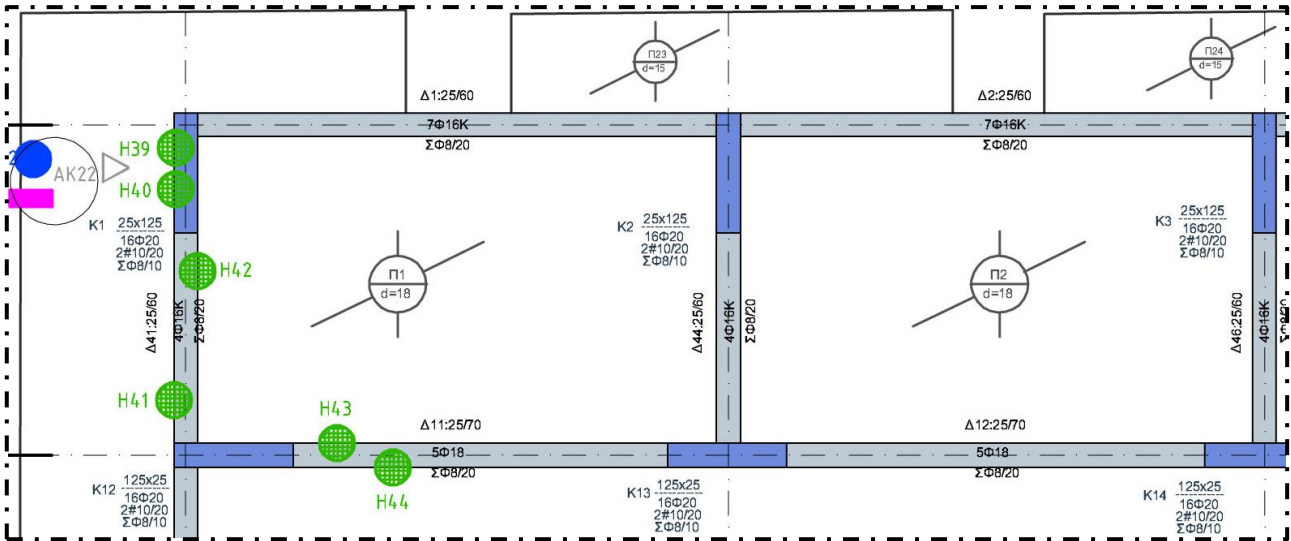

Figure 69 – Extract of the structural survey of the ceiling of the first floor – Source: [143]

In Figure 69 an extract from the plans obtained from the structural surveys, showing cross-sections, reinforcement, and location of samples for the test is shown. On the basis of the structural survey [143] the drawings of the initial state were produced (Figures 70 and 71) and are attached to the thesis (Appendix A).

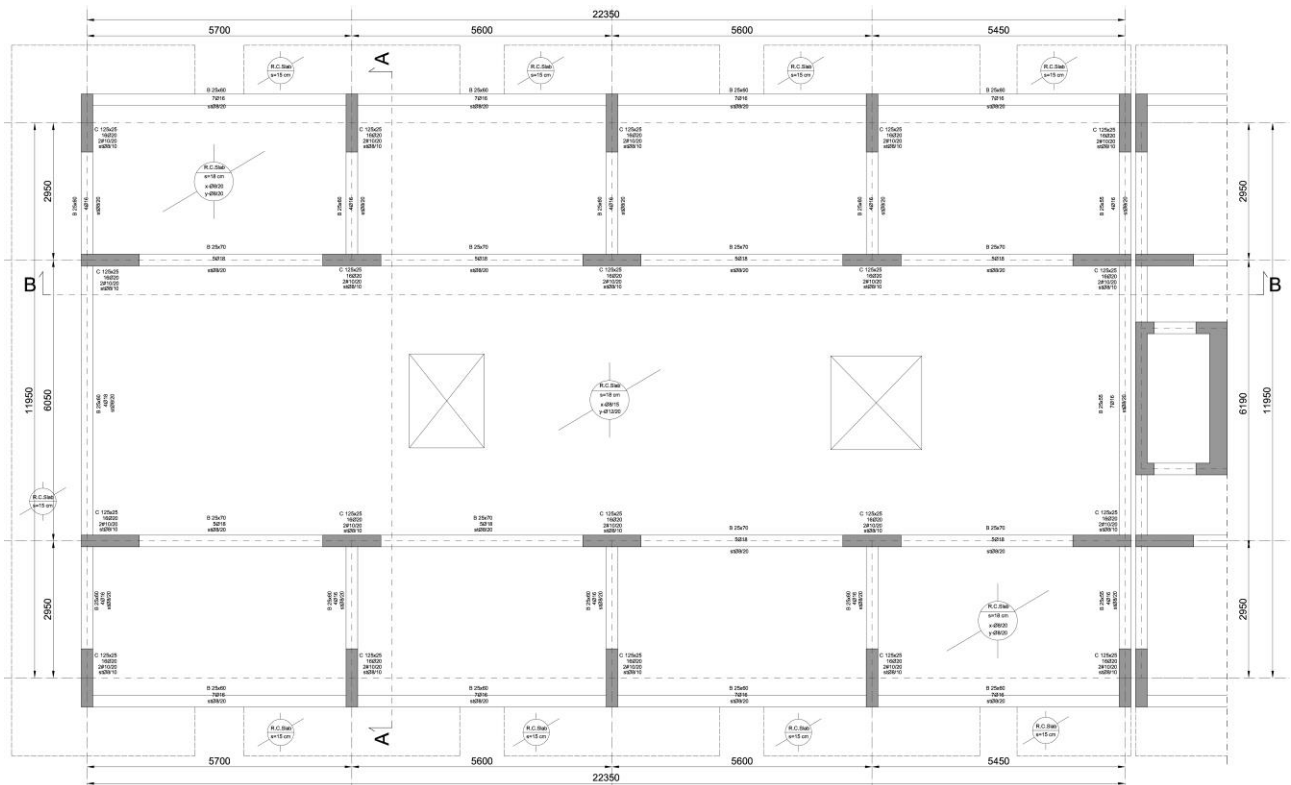

Figure 70 – Typical structural plan of the RC moment resisting frame of the Athens case study (mm as units)

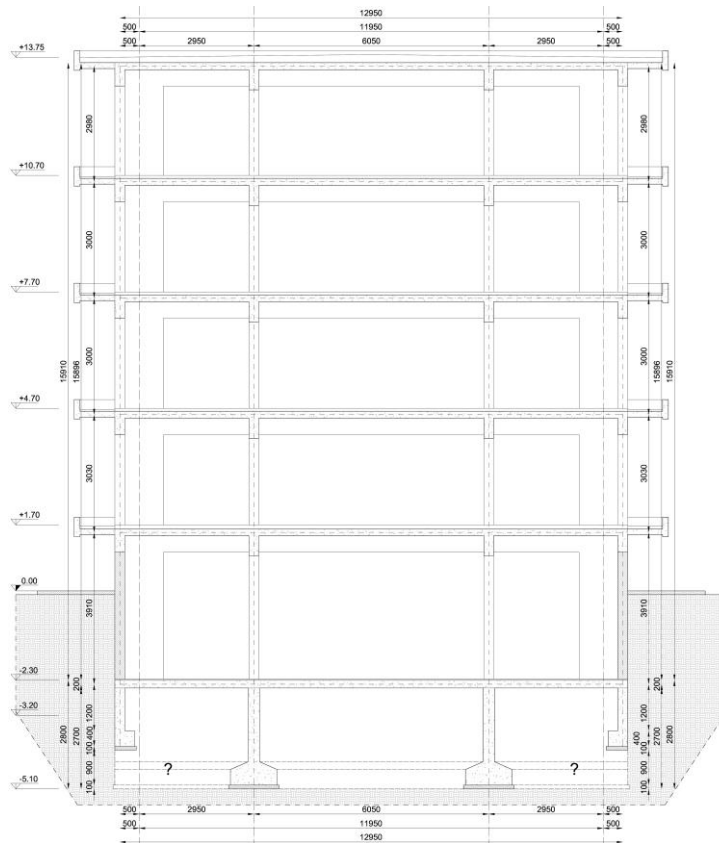

Figure 71 – Structural vertical cross-section of the RC moment resisting frame of the Athens case study (mm as units)

As shown in Figure 69, the structural survey reported the dimensions of the cross-section, the longitudinal reinforcement at the lower edge of the beams (the same quantities were set at the top of the beam near the joints) and the transverse reinforcement with related spacing (Table 26). The beams and the slabs of the structure are cast at the same time and therefore imply a collaboration represented in the FEM model considering T and L shapes for the internal and perimeter beams respectively. The flanges applied to the RC beams have a length of 18 cm, equal to the thickness of the collaboration slab. As for the columns, the arrangement of the reinforcements was determined through the indications of the drawings and with the images obtained by the rebar detector (Figure 72) [143].

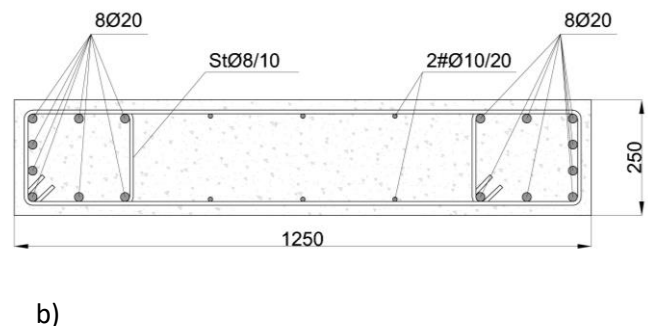
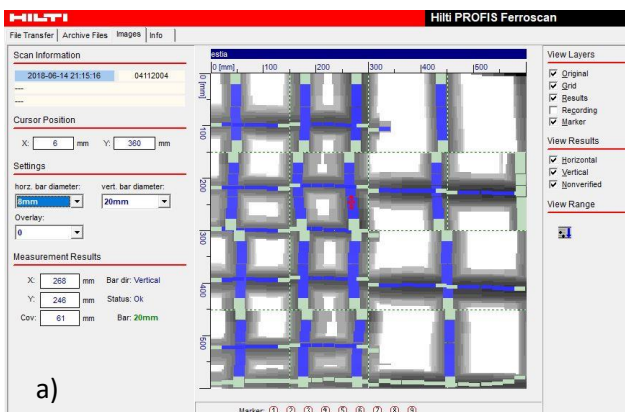

Figure 72 – a) Magnetic scanning across the K34 column, showing three vertical bars with a 20 mm diameter, one 10 mm diameter vertical bar towards the centre and horizontal bars of 8 mm diameter with different spacing; b) representation of the cross-section of the column with related reinforcement bars (mm as units) – Source: [143]

Table 26 – Data related to the RC beams

Name	Cross-section mm	Longitudinal reinforcement n° ϕ (mm)	Transverse reinforcement ϕ /step (mm)
Beam 1	250x700	5 ϕ 18	ϕ 8/200
Beam 2	250x600	4 ϕ 16	ϕ 8/200
Beam 3	250x550	4 ϕ 16	ϕ 8/200
Beam 4	250x550	7 ϕ 16	ϕ 8/200
Beam 5	250x600	7 ϕ 16	ϕ 8/200
Beam 6	250x600	4 ϕ 18	ϕ 8/200

Finally, some information on the foundation system was reported, mostly consisting of the foundation level and approximate dimensions of the cross-sections. Due to the lack of data regarding the planimetric development of the foundations and the supporting ground, only qualitative hypotheses were made regarding the actual conformation of the foundations and subsequently on the proposed intervention hypothesis.

5.1.1.3 Modelling parameters

Load patterns

The stratigraphy of the floors is defined from intrados to extrados as follow.

- Roof: 15 mm plaster (0.3 kN/m²), 180 mm RC slab (4.5 kN/m²), maximum 150 mm lightweight screed (1.5 kN/m²), and 5 mm perlite/bitumen membrane (0.045 kN/m²).
- Intermediate floors: 15 mm plaster (0.3 kN/m²), 180 mm RC slab (4.5 kN/m²), 55 mm lightweight screed (0.55 kN/m²), and 20 mm marble pavement (0.55 kN/m²) as heaviest solution.
- Ground floor: 180 mm RC slab (4.5 kN/m²) and 20 mm marble pavement (0.55 kN/m²) as heaviest solution.

The following tables show the loads considered in the model (Tables 27, 28 and 29). The categories selected for imposed and snow loads refer to the Eurocode 1 [134, 135]. A was chosen for the areas dedicated to students' rooms and C3 for the central corridors. A indicates the areas for domestic and residential activities, while C3 represents the areas where people may congregate.

Table 27 – Load patterns assigned to the floors of the storeys – Source: [134, 135]

	Floors		
	Self-weight	Dead load	Live load
Roof	4.5 kN/m ²	1.845 kN/m ²	C3 = 5 kN/m ² ; Snow = 0.34 kN/m ²
First/second and third floor	4.5 kN/m ²	3 kN/m ²	C3 = 5 kN/m ² ; A = 2 kN/m ²
Ground floor	4.5 kN/m ²	3.3 kN/m ²	C3 = 5 kN/m ² ; A = 2 kN/m ²

Table 28 – Load patterns of the external walls

	Perimeter walls		
	Self-weight	Dead load	Live load
Masonry with plaster (250 mm)	–	12 kN/m	–
External partition with openings	–	5 kN/m	–

The existing balconies were considered through the application of external loads on the perimeter beams of three sides. A 1 m depth cantilever beam was considered in two configurations (A and B from Figure 73). Cantilever beams of 1.5 m and 1 m were considered on the short and long sides of the building respectively. Considering the thickness of the balcony slab (15 cm), the concrete railing and the imposed load associated

with the balconies (4 kN/m^2), the vertical reactions (R) and moments (M) were distributed along the external beams as shown in Figure 73 and quantified in Table 29.

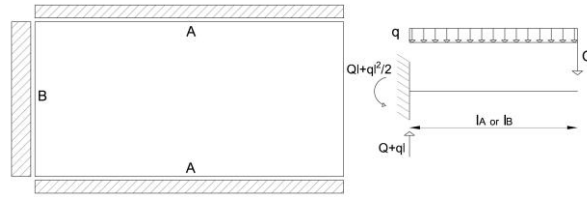

Figure 73 – Schemes representing the application of external loads on the perimeter beams

Table 29 – Representative external loads of balconies applied to perimeter beams

Type plan – Balcony loads		
Side / Action	Dead load	Live load
A/R	6.33 kN/m	4 kN/m
A/M	4.1 kNm/m	2 kNm/m
B/R	8.55 kN/m	6 kN/m
B/M	7.82 kNm/m	4.5 kNm/m
Roof plan – Balcony loads		
Side / Action	Dead load	Live load
A/R	4.45 kN/m	–
A/M	2.23 kNm/m	–
B/R	6.68 kN/m	–
B/M	5.01 kNm/m	–

Definition of the mass source and seismic load combinations

The definition of combination of loads and masses to be used for seismic analysis is based on the Eurocodes 0 [136] and 8 [12]. All coefficients and combinations factors used are reported in Table 30, and (5.1) represent the equation for the definition of the masses.

Table 30 – Combination factors to define load combinations and masses for seismic actions – Source: [12, 136]

Categories	ψ_{2j} (Load combinations)	φ	$\psi_{Ej} = \varphi \cdot \psi_{2j}$ (Masses)
A	0.3	0.8	0.24
C3	0.6	0.8	0.48
H	0	1	0
I (C3)	0.6	1	0.6

$$G_1 + G_2 + \sum_j \psi_{Ej} Q_{kj} = G_1 + G_2 + 0.24Q_A + 0.48Q_{C3} + 0.0Q_H + 0.6Q_{I-C3} \quad (5.1)$$

- G_1 - self weight
- G_2 - dead load
- Q_A - live load, areas for domestic and residential activities
- Q_{C3} - live load, areas where people may congregate
- $Q_{I(C3)}$ - live load, accessible roof
- Q_H - snow load

Changing the combination factor ψ_{Ej} to ψ_{2j} in (5.1) gives the quasi-permanent (QP) load combination, which, when added to the horizontal loads, derived from the design response spectra (at the various limit states), defines the seismic load combinations used in the dynamic linear analyses.

Following the definition of the model and masses, the natural vibration modes of the structure are determined with an eigenvalue analysis, dynamically characterising the response of the structure. By applying the design response spectrum to each vibration mode, the maximum values of stresses and displacements are then determined and finally combined, using the principle of superposition of effects. As linear analyses, the energy dissipation during the earthquake is considered through the introduction of the q-factor (behaviour factor) which leads to a reduction of the horizontal actions resulting from the elastic response spectrum (design response spectrum). Three elastic response spectra are determined for the three performance level defined in the Eurocode 8 – Part 3 [11].

- LS DL – Limit state of damage limitation
- LS SD – Limit state of significant damage
- LS NC – Limit state of near collapse

The q-factor is calculated from the results of the non-linear static analysis (pushover) and represents the progressive damage of the RC elements. Non-linear static analyses are carried out with reference to Eurocode 8 [12] considering two horizontal force distributions: a "uniform" pattern, with lateral forces proportional to the masses regardless of elevation; and a "modal" pattern, proportional to the lateral forces deriving from the vibration modes. Four pushover analyses were performed to determine the behaviour of the structure in the two main directions (X and Y). Therefore, the following analyses have been performed.

- ULS: Ultimate limit states
- SLS: Serviceability limit states
- QP: Quasi-permanent vertical loads combination
- LS DL [+QP]: DL Response spectrum modal analysis in combination with QP
- LS SD [+QP]: SD Response spectrum modal analysis in combination with QP
- GRAV: non-linear static vertical loads based on the QP combination
- PUSH_X: non-linear static horizontal loads – uniform pattern acting along the longitudinal direction
- PUSH_Y: non-linear static horizontal loads – uniform pattern acting along the transverse direction
- PUSH_X Mode: non-linear static horizontal loads – modal pattern based on the vibration mode acting in longitudinal direction
- PUSH_Y Mode: non-linear static horizontal loads – modal pattern based on the vibration mode acting in transverse direction

Restraints/Constraints/Cracking

Fixed joints, involving all six degrees of freedom, were introduced at the foundation level as external restraints due to a lack of information on the development of foundations and soil characteristics.

Diaphragm rigid constraints were defined and applied to all the joints belonging to the floor levels due to the presence of 180 mm thick RC slabs.

Cracking phenomena were considered by introducing reduced effective shear and bending stiffnesses for the structural elements with the approach presented in Table 31 [144]. In particular, the bending stiffness of the beams is multiplied by 0.3, while for vertical elements 0.7 is set for columns, considering the positive influence of the compression and 0.5 for the walls. The latter is chosen for safety because of the dimensions of the vertical elements and also to comply with the indications of Eurocode 8 [12]. The shear stiffness is multiplied for both beams and columns by 0.4.

Table 31 – Effective stiffness values considering cracking – Source: [144]

Component	Bending Stiffness	Shear Stiffness
Beams	$0.3 E_c I_g$	$0.4 E_c A_w$
Columns	$0.5 E_c I_g$	$0.4 E_c A_w$

Response spectrum functions and q-factors

Figure 74 – Horizontal elastic response spectra for the three considered performance levels

Three reference elastic spectra, corresponding to the three main limit states, are defined to calculate the seismic demand for the non-linear analysis (Figure 74) and to perform the linear dynamic analysis. The definition of the acceleration value is based on Eurocode 8 [11, 12], using the data given in Table 32. The peak ground acceleration values are determined based on the Greek national seismic zones EAK2000 [112]. The soil type is taken from data found in the literature and has been classified as B. The building is classified with an importance class III, so each acceleration value is multiplied by 1.2.

Table 32 – Seismic parameters for the definition of the elastic response spectra – Source: [11, 12]

Spectrum type 1 – Ground type B – Seismic Zone I, EAK2000 [112]		$\gamma_I = 1.2$
LS DL – $P_{VR} = 20\%$; $T_R = 225$ years; $V_R = 50$ years	$a_{gR} = 0.126g$	$a_g \cdot \gamma_I = 0.151g$
LS SD – $P_{VR} = 10\%$; $T_R = 475$ years; $V_R = 50$ years	$a_{gR} = 0.160g$	$a_g \cdot \gamma_I = 0.192g$
LS NC – $P_{VR} = 2\%$; $T_R = 2475$ years; $V_R = 50$ years	$a_{gR} = 0.281g$	$a_g \cdot \gamma_I = 0.337g$

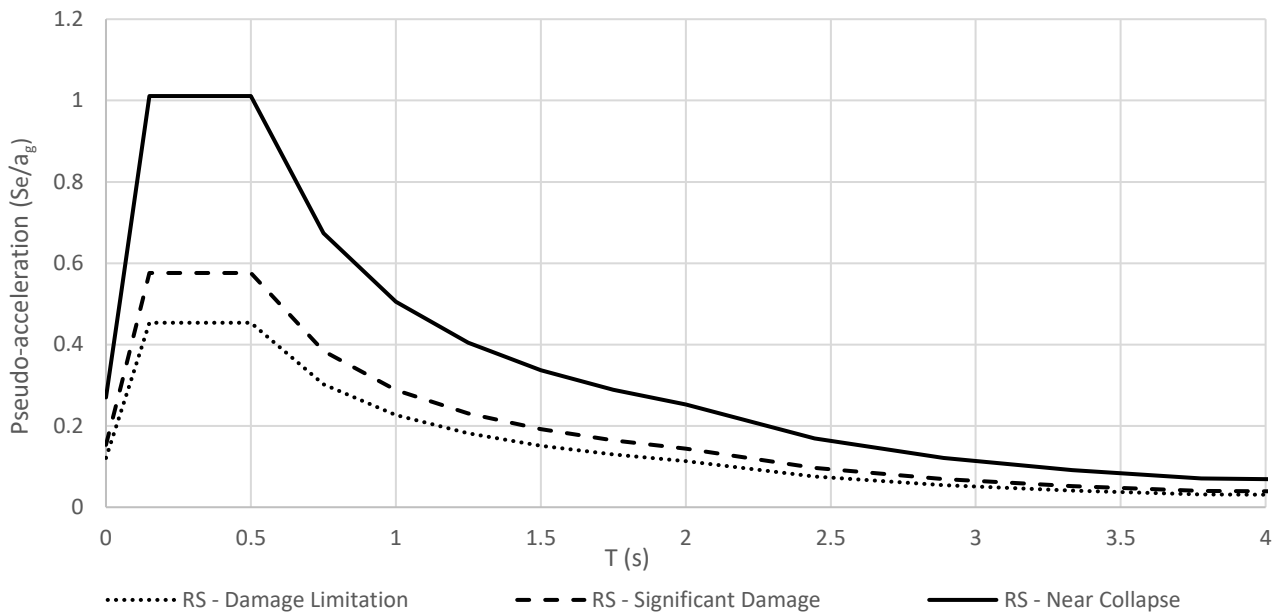
For linear dynamic analysis the design response spectrum for LS SD is calculated by dividing the ordinates of the elastic response spectrum by the q-factor. The latter depends on the regularity of the structure and on the ratio between the maximum horizontal force supported by the structure and the horizontal force corresponding to the formation of the first plastic hinge (first hinge reaching the elastic limit) as indicated by the Eurocodes (5.2) and (5.3) [11, 12]. Using the minimum overstrength ratio (α_u/α_1) obtained from the pushover analysis performed in the same directions, two separate q-factors are given for the two main directions, which means two different design response spectra are applied. Regarding the verifications of brittle mechanisms, these were carried out with a q-factor of 1.5 as indicated in the Eurocodes [11].

$$q = q_0 \cdot K_r \quad (5.2)$$

with

$$q_0 = 3 \frac{\alpha_u}{\alpha_1} \quad (5.3)$$

- α_u - maximum horizontal action value supported by the structure before collapse;
- α_1 - horizontal action value corresponding to the formation of the first hinge;
- K_r - coefficient for considering the structural regularity, in this case equal to 0.8.

Table 33 – q-factor values for the initial state

LS Significant Damage	q – Initial state
Pushover analysis in longitudinal direction (X)	3.01
Pushover analysis in transverse direction (Y)	2.84
Verification for brittle failures	1.50

Plastic hinges

In order to perform the static non-linear analysis, the non-linear behaviour of all resistant elements involved in the analyses was defined. Beams and columns were modelled as nonlinear frame elements with lumped plasticity by defining plastic hinges at both ends of the elements. The hinge properties follow the formulas reported in the Annex A of the Eurocode 8-Part 3 [11] for ductile mechanisms and can identify the performance levels for each step of the non-linear static analysis (5.4), (5.5) and (5.6). The behaviour of these hinges is depending on the cross-section of the element, the material properties, the longitudinal and transversal steel reinforcements, and the axial loads calculated with a QP-combination of vertical loads. SAP2000 [129] provides default-hinge properties, PMM (combined bending and axial loads) hinges for columns and M3 (only bending loads) hinges for beams were assigned. In order to take into account brittle failures on the same elements, force-controlled hinges were placed in the middle of each column and at the ends of each beam (V2 for beams and V2-V3 for columns). The shear strength, which is the maximum allowable force for these hinges, is calculated with reference to the paragraph 6.2.3 of Eurocode 2 [133] with (5.7), (5.8) and (5.9). In Figure 76 the internal axes of reference for the beam elements are shown.

Displacement controlled non-linear hinges, placed at the ends of existing beams and columns.

- M3 for beams – Bending failure condition
- P-M2-M3 for columns – Combined axial and bending failure condition (axial loads from QP)

$$\theta_u = \frac{1}{\gamma_{el}} 0.016 \cdot (0.3^v) \left[\frac{\max(0.01; \omega')}{\max(0.01; \omega)} f_c \right]^{0.225} \left(\frac{L_V}{h} \right)^{0.35} 25 \left(\alpha_{psx} \frac{f_{yw}}{f_c} \right) (1.25^{100} \rho_d) - \text{LS NC} \quad (5.4)$$

$$\theta_{SD} = \frac{3}{4} \theta_u - \text{LS SD} \quad (5.5)$$

$$\theta_y = \phi_y \frac{L_V + a_v z}{3} + 0.0014 \left(1 + 1.5 \frac{h}{L_V} \right) + \frac{\varepsilon_y}{d-d'} \frac{d_{bl} f_y}{6\sqrt{f_c}} - \text{LS DL} \quad (5.6)$$

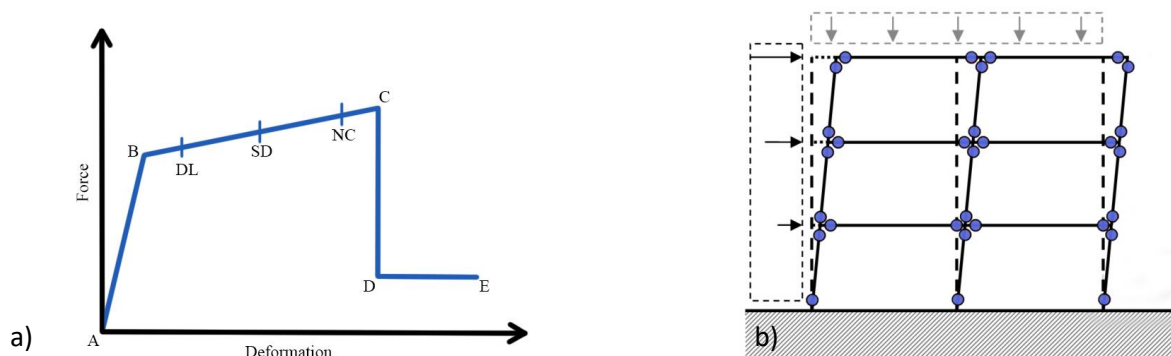

Figure 75 – a) Back-bone curve provided for each deformation-controlled plastic hinge, with relative limit state limits (DL, SD, and NC); b) Scheme representing the positioning of the deformation-controlled plastic-hinges on a frame

Force controlled plastic hinges were placed in the ends of the beams and in the middle of each column.

- V2 for beams – Shear force failure
- V2-V3 for columns – Shear force failure

$$V_{Rd} = \min(V_{Rsd}; V_{Rcd}) - \text{LS NC} \tag{5.7}$$

$$V_{Rsd} = z \cdot \frac{A_{sw}}{s} \cdot f_{ywd} \cdot \cot \theta \tag{5.8}$$

$$V_{Rsd} = z \cdot b_w \cdot \alpha_{cw} \cdot \frac{v_1 \cdot f_{cd}}{(\tan \theta + \cot \theta)} \tag{5.9}$$

- f_{cd} - reduced design compressive strength of concrete ($f'_{cd} = 0.5 \cdot f_{cd}$)
- A_{sw} - area of the confinement bars
- α - angle of inclination of the transverse bars with respect to the beam axis
- α_{cw} - increased coefficient
- s - span between confinement bars
- b_w - minimum width of the section
- f_{ywd} - design value of yield strength of steel
- z - usually $0.9 \cdot d$ (d is the useful height of the section)
- v_1 - strength reduction factors for concrete cracked in shear

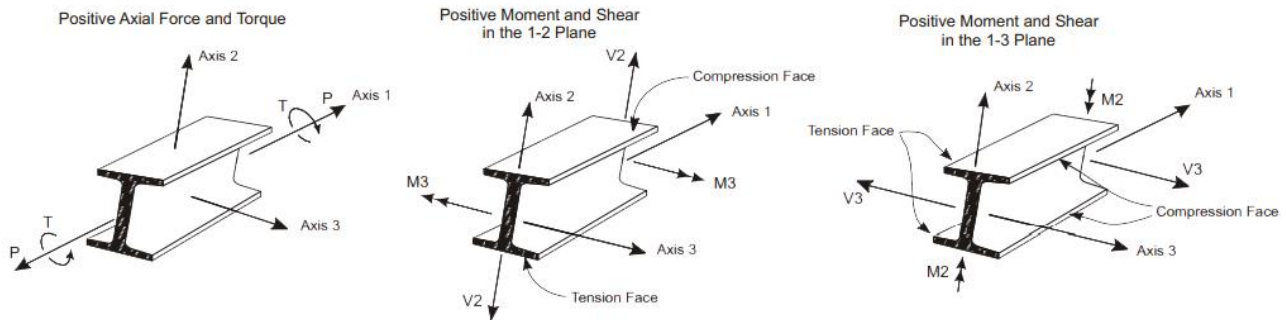

Figure 76 – Frame element internal forces and moments as reference on the internal axis – Source: [145]

5.1.1.4 Results

Modal analysis

The evaluation of the dynamic behaviour of the building is carried out by means of a modal analysis performed on the structural model. The analysis is carried out considering the first 24 vibration modes (modal masses greater than 5%) and checking that the total mass activated by the modes is greater than 85%. The following are the results of the first four vibration modes (Table 34).

Table 34 – Results of the modal analysis of the initial state; periods are indicated in seconds while participating masses are percentages of the total mass of the building

Mode	Period (s)	Initial State		
		U1	U2	RZ
1	0.759	0	80.75%	2.85%
2	0.733	0	2.91%	81.31%
3	0.683	85.80%	0	0
4	0.226	≈ 0	11.70%	≈ 0

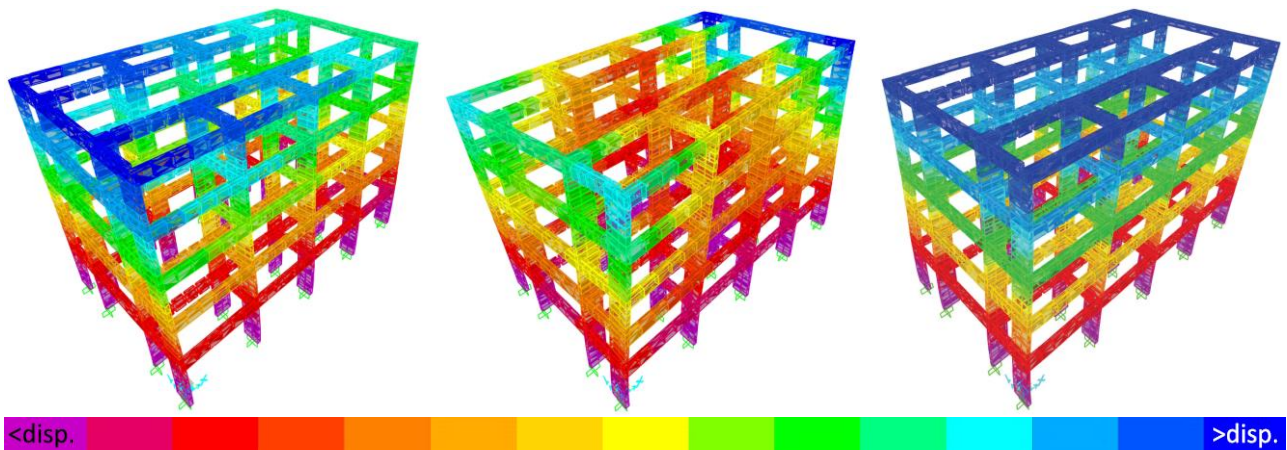

Figure 77 – Representation of the first three main vibration modes in ascending order from left to right; the displacements increase from purple to blue

As shown by the participating masses (Table 34) and the modal displacements (Figure 77) the dynamic behaviour of the structure is characterised by a significant torsional component. In fact, in the first mode the north side has a greater displacement than the south side due to the presence of the balconies and the wider spans which shift the centre of masses towards that side. This behaviour is then confirmed by the second vibration mode which is mainly torsional with 81% of activated mass.

Linear dynamic analysis

Using the design response spectrum, the maximum seismic action effects associated with each vibration mode were calculated and combined, directly from the software, using the complete quadratic combination (CQC). The response determined by two horizontal components with respect to the two main directions (X and Y) were combined by alternating the total contribution in one direction and 30% in the other direction and permuting the signs of the contributions until the combinations were complete. An basic eccentricity of the mass centre was calculated at 5% as indicated in the Eurocodes [12]. In addition to providing the maximum stresses in the structural elements, the linear dynamic analysis allows to evaluate the maximum and inter-storey displacements. The displacements are a fundamental parameter to evaluate the behaviour of the structure during the earthquake before and after the intervention and allow a direct comparison between the initial and project state. Table 35 shows the maximum top-displacements found at the DL LS for both main directions.

Table 35 – Maximum displacements calculated with the linear dynamic analysis for both main directions (X and Y)

Athens case study	Initial State	
LS DL	U1 (mm)	U2 (mm)
δ_{max} (Roof)	63.9	76.2

The vulnerability analysis was then carried out in terms of maximum stresses in the structural elements and interstorey displacements. In both cases the design spectra were progressively reduced until the verifications were satisfied, indicating a maximum percentage of seismic action supported by the structure $E(a_g)_{LS}$. In the first case, the stresses of the structural elements were extrapolated by means of the finite element software and compared with the manually calculated resistances with reference to Eurocode 2 [133]. The vulnerability assessment carried out with dynamic linear analysis (force-based design) for LS SD was found to be satisfied with 40-45% of the design seismic loads.

$$40\% \leq E(a_g)_{LS SD} \leq 45\%$$

For the interstorey drift verifications, the same procedure was applied by directly using the elastic spectrum defined for the LS DL (reference to the previous paragraph on elastic response spectra) as design spectrum. Below in Figure 78 a graph is showing the verification of the interstorey drift followed by the related vulnerability assessment stated at 89% on the design requirement for that performance level.

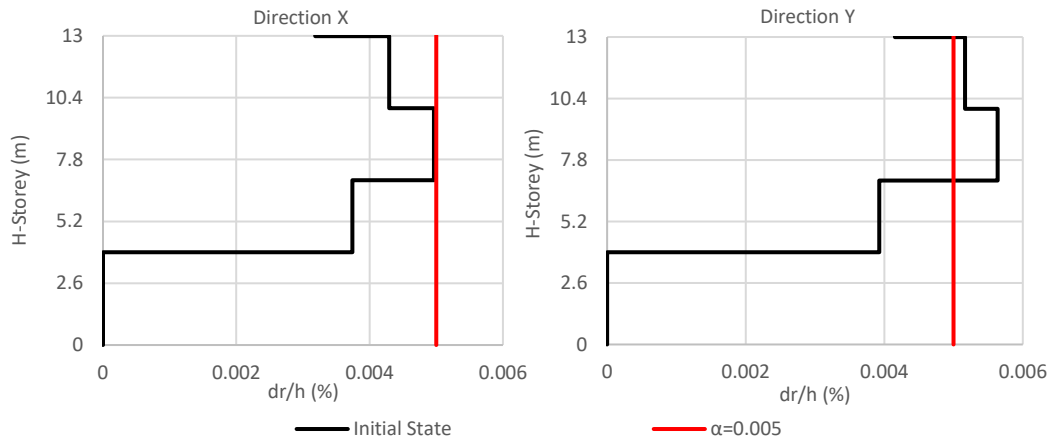

Figure 78 – Interstorey drift verification for the initial state of the Athens case study for both main directions at LS DL

$$E(\alpha_g)_{LS DL} = 89\%$$

Non-linear static analysis (pushover)

The pushover analysis applies first the vertical loads on the basis of the quasi-permanent combination and second the horizontal loads to all the storeys following the two lateral load distributions indicated above. The horizontal forces increase monotonically while the displacement of the control point (usually located on the roof) is recorded step by step. The resultant curves represent base shear and control point displacement for each step. During the analysis the response of all the non-linear hinges is recorded indicating their relative performance state (Figure 75a).

The application of pushover analysis is most effective (and conservative) when the structure meets the regularity criteria, as the distributions of horizontal forces along the main directions tend to neglect torsional phenomena. The results of the modal analysis show a relevant torsional component, but also a percentage of mass activated in the first transverse mode (Y-U2) of 81% and, considering the third mode of vibration for the longitudinal direction (X-U1), 86%. With reference to the previous Italian regulations [110], when the participating mass for a given mode of vibration of the structure is greater than or equal to 75% of the total, it is considered effective to determine its seismic response with non-linear static analysis.

The capacity curves of the structure were obtained for the MDOF model (Section 5.1.2.5) and resulting in several reference parameters:

- using the target displacement verification (TDV) method (Annex B of [12]), the displacement capacities were evaluated and compared to the demands (D/C);
- the stiffness values at 60% (K_{60}) of the maximum seismic action are obtained in relation to the corresponding displacement representing the slope of the initial part (linear behaviour) of the elastic perfectly plastic related system;

$$K_{60} = \frac{0.6F_u}{d_{(0.6F_u)}} \quad (5.10)$$

- the reference collapse acceleration ($a_{g,c}$) for the MDOF is reported as a simplified procedure to evaluate the maximum capacity of the structure in terms of force and obtained as the ratio between the total horizontal force capacity of the structure (calculated with respect to the performance levels,

LS) and the mass activated along that direction by the vibration mode. By comparing this value with the pseudo-acceleration obtained from the elastic response spectrum as a function of the natural period, a further relationship between capacity and demand (C/D) is presented. This parameter partly neglects the contribution given by energy dissipation and has been proposed as a means of comparison in terms of global strength (overall force).

$$\frac{C}{D} = \zeta_E = \frac{a_{g,d}}{a_{g,c}} \leq 1 \tag{5.11}$$

- ζ_E - structural vulnerability in terms of maximum horizontal forces
- $a_{g,d}$ - pseudo-acceleration obtained from the elastic response spectrum
- $a_{g,c} = \frac{V_{max,LS}}{m^* \cdot g}$ - collapse acceleration associated with exceeding the LS limit by a plastic hinge
- $V_{max,LS}$ - maximum horizontal force for which at least one plastic hinge reaches the LS
- m^* - participating mass of the vibration mode acting in the same direction of the forces

The main results of the initial state for the Athens case study are presented below.

Initial state, Athens case study (uniform force distribution – X)

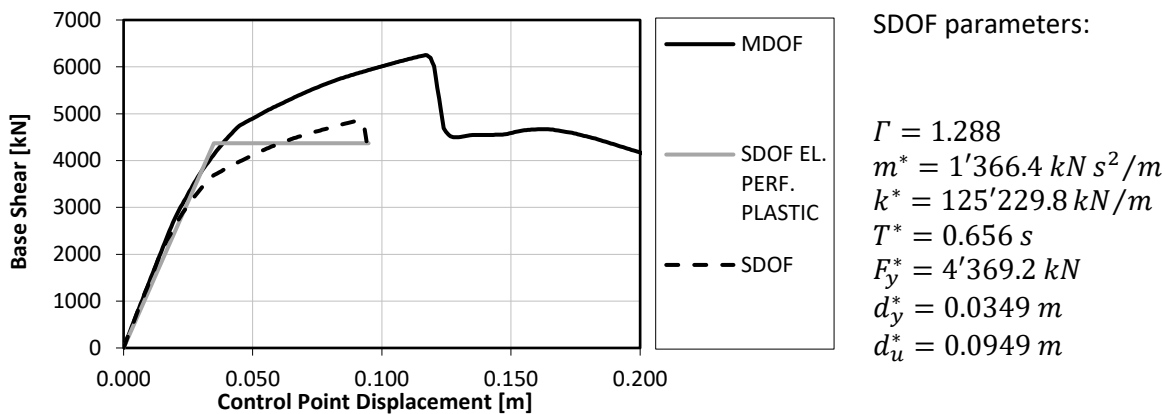

Figure 79 – Representation of the capacity curves for both MDOF and SDOF systems and relative bi-linearisation of the SDOF curve with the use of the parameters reported on the right; uniform force distribution along X-direction

Table 36 – Pushover analysis results; uniform force distribution along X-direction

Assessment results – LS Damage Limitation	
Displacement demand (D)	49.49 mm
Displacement capacity (C)	52.17 mm
D/C Ratio	94.9%
K_{60}	125'230 kN/m
Total shear capacity - V_{max}	4'964 kN
$S_e(T)$	0.334 g
$a_{g,c}$	0.288 g
C/D Ratio	86%
Assessment results – LS Significant Damage	
Displacement demand (D)	62.85 mm
Displacement capacity (C)	103.50 mm
D/C Ratio	60.7%
K_{60}	125'230 kN/m
Total shear capacity - V_{max}	6'064 kN

$S_e(T)$	0.424 g
$a_{g,c}$	0.351 g
C/D Ratio	83%
Assessment results – LS Near Collapse	
Displacement demand (D)	110.31 mm
Displacement capacity (C)	116.84 mm
D/C Ratio	94.4%
K_{60}	125'230 kN/m
Total shear capacity - V_{max}	6'252 kN
$S_e(T)$	0.743 g
$a_{g,c}$	0.362 g
C/D Ratio	49%

Initial state, Athens case study (modal force distribution – X)

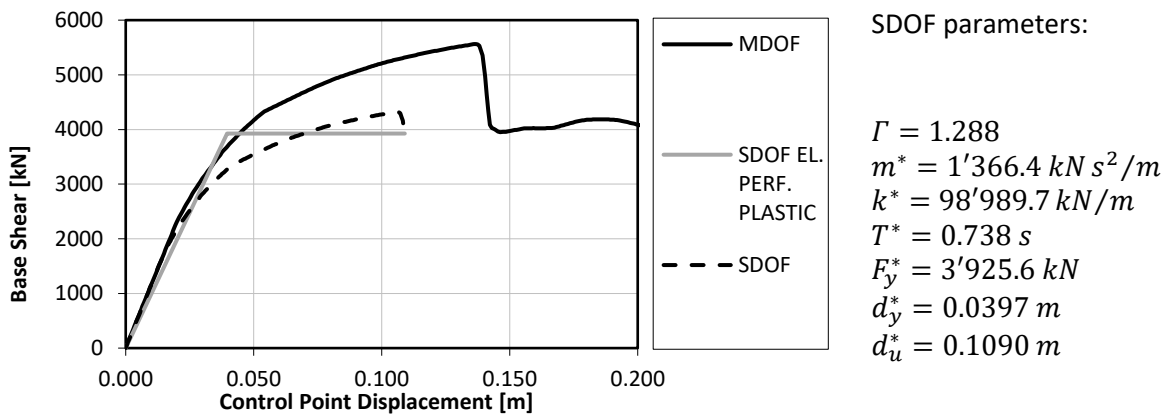

Figure 80 – Representation of the capacity curves for both MDOF and SDOF systems and relative bi-linearisation of the SDOF curve with the use of the parameters reported on the right; modal force distribution along X-direction

Table 37 – Pushover analysis results; modal force distribution along X-direction

Assessment results – LS Damage Limitation	
Displacement demand (D)	53.98 mm
Displacement capacity (C)	58.35 mm
D/C Ratio	92.5%
K_{60}	98'990 kN/m
Total shear capacity - V_{max}	4'425 kN
$S_e(T)$	0.334 g
$a_{g,c}$	0.256 g
C/D Ratio	77%
Assessment results – LS Significant Damage	
Displacement demand (D)	68.54 mm
Displacement capacity (C)	120.75 mm
D/C Ratio	56.8%
K_{60}	98'990 kN/m
Total shear capacity - V_{max}	5'435 kN
$S_e(T)$	0.424 g
$a_{g,c}$	0.315 g
C/D Ratio	74%
Assessment results – LS Near Collapse	
Displacement demand (D)	120.31 mm

Displacement capacity (C)	136.35 mm
D/C Ratio	88.2%
K₆₀	98'990 kN/m
Total shear capacity - V_{max}	5'563 kN
S_e(T)	0.743 g
a_{g,c}	0.322 g
C/D Ratio	43%

Initial state, Athens case study (uniform force distribution – Y)

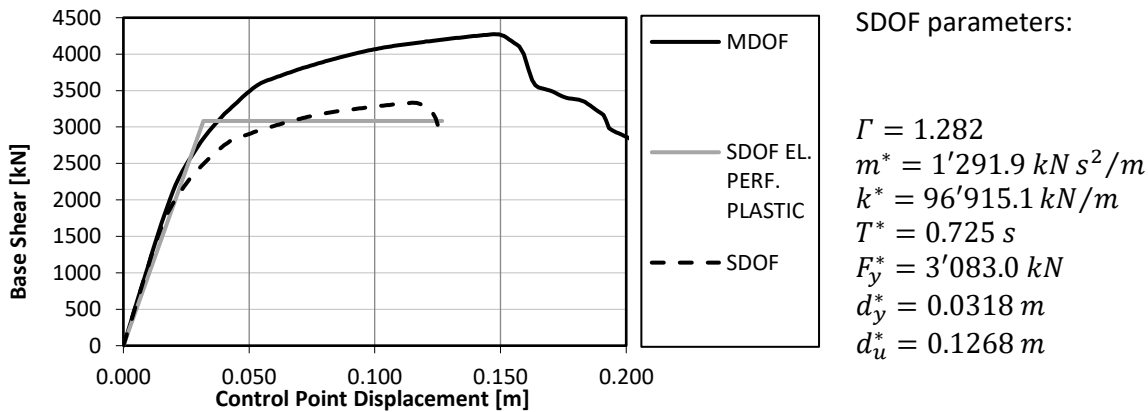

Figure 81 – Representation of the capacity curves for both MDOF and SDOF systems and relative bi-linearisation of the SDOF curve with the use of the parameters reported on the right; uniform force distribution along Y-direction

Table 38 – Pushover analysis results; uniform force distribution along Y-direction

Assessment results – LS Damage Limitation	
Displacement demand (D)	53.18 mm
Displacement capacity (C)	55.68 mm
D/C Ratio	95.5%
K₆₀	96'915 kN/m
Total shear capacity - V_{max}	3'618 kN
S_e(T)	0.298 g
a_{g,c}	0.223 g
C/D Ratio	75%
Assessment results – LS Significant Damage	
Displacement demand (D)	67.532 mm
Displacement capacity (C)	128.425 mm
D/C Ratio	52.6%
K₆₀	96'915 kN/m
Total shear capacity - V_{max}	4'206 kN
S_e(T)	0.379 g
a_{g,c}	0.259 g
C/D Ratio	68%
Assessment results – LS Near collapse	
Displacement demand (D)	118.532 mm
Displacement capacity (C)	147.425 mm
D/C Ratio	80.4%
K₆₀	96'915 kN/m
Total shear capacity - V_{max}	4'274 kN
S_e(T)	0.665 g

$a_{g,c}$	0.263 g
C/D Ratio	39%

Initial state, Athens case study (modal force distribution – Y)

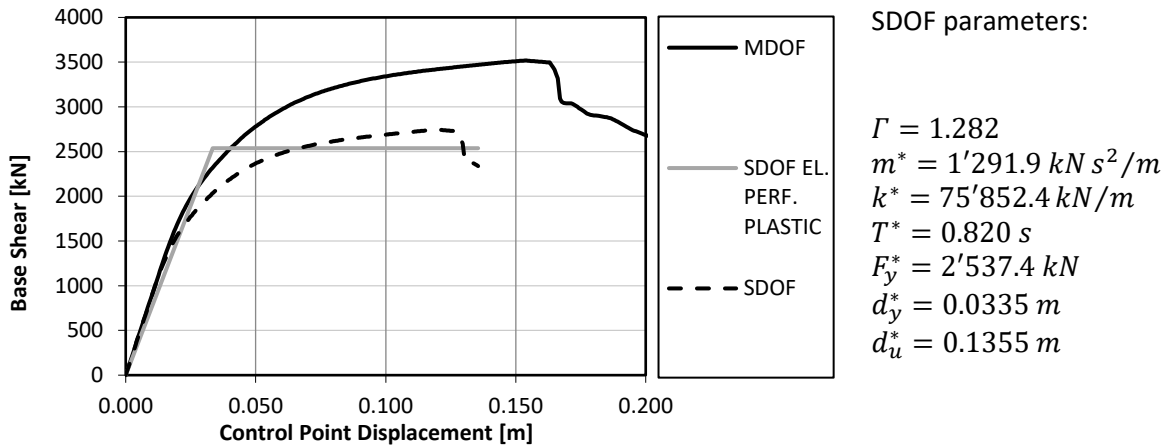

Figure 82 – Representation of the capacity curves for both MDOF and SDOF systems and relative bi-linearisation of the SDOF curve with the use of the parameters reported on the right; modal force distribution along Y-direction

Table 39 – Pushover analysis results; modal force distribution along Y-direction

Assessment results – LS Damage Limitation	
Displacement demand (D)	60.23 mm
Displacement capacity (C)	46.85 mm
D/C Ratio	128.6%
K_{60}	75'852 kN/m
Total shear capacity - V_{max}	2'710 kN
$S_e(T)$	0.298 g
$a_{g,c}$	0.167 g
C/D Ratio	56%
Assessment results – LS Significant Damage	
Displacement demand (D)	76.49 mm
Displacement capacity (C)	135.47 mm
D/C Ratio	56.5%
K_{60}	75'852 kN/m
Total shear capacity - V_{max}	3'470 kN
$S_e(T)$	0.379 g
$a_{g,c}$	0.214 g
C/D Ratio	57%
Assessment results – LS Near collapse	
Displacement demand (D)	134.25 mm
Displacement capacity (C)	153.47 mm
D/C Ratio	87.5%
K_{60}	75'852 kN/m
Total shear capacity - V_{max}	3'518 kN
$S_e(T)$	0.665 g
$a_{g,c}$	0.217 g
C/D Ratio	33%

Figures 83 and 84 show the steps of the non-linear analysis in which the model of the initial state reaches the crisis. The latter occurs in the columns for combination of compressive and bending stresses, for both horizontal load distributions and directions.

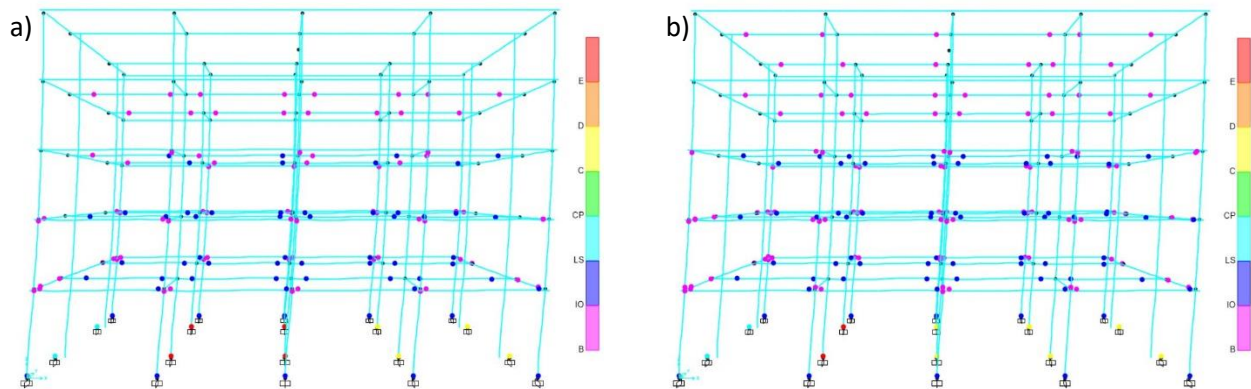

Figure 83 – Structural response of pushover analyses in the X-direction, where in both cases the collapse occurs at the base of the ground floor columns. The non-linear hinges indicate the ductile behaviour of the resisting elements going from pink to red. The blue hinges represent the LS DL, the light blue LS SD and from green onwards LS NC is identified. a) uniform force distribution along X-direction; b) modal force distribution along X-direction

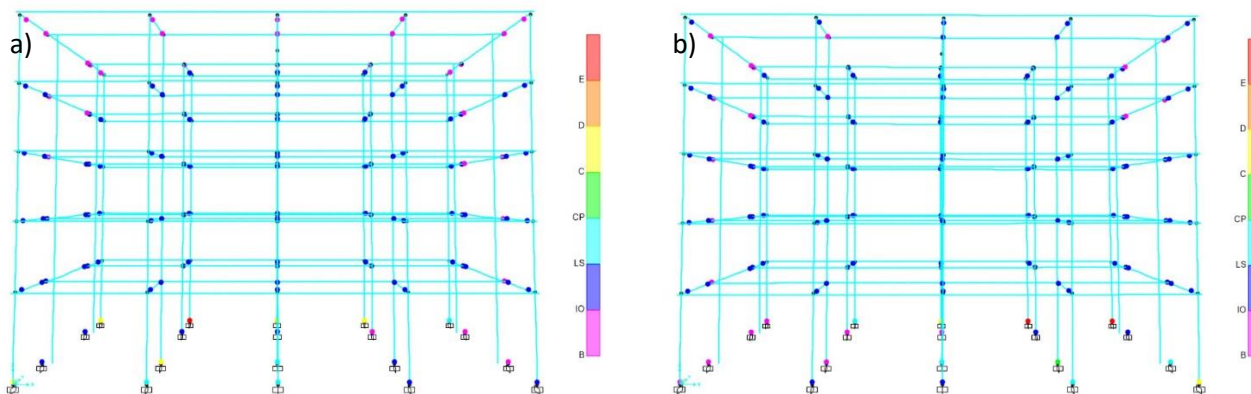

Figure 84 – Structural response of pushover analyses in the Y-direction, where in both cases the collapse occurs at the base of the ground floor columns. The non-linear hinges indicate the ductile behaviour of the resisting elements going from pink to red. The blue hinges represent the LS DL, the light blue LS SD and from green onwards LS NC is identified. a) uniform force distribution along Y-direction; b) modal force distribution along X-direction

In relation to the results reported above:

- TDVs are substantially verified in the various limit states, except for a vulnerability to the LS DL in the transverse direction (Y) with a value of 78% of the design requirements. This result indicates a good behaviour of the building in its inelastic phase, even if the evaluation is partially compromised by the torsional behaviour that could lead to non-conservative results related to a reduction of the participating mass in the direction of the seismic loads.
- As exposed by the target displacement result, compared to the longitudinal direction, the stiffness of the structure is 30% lower in the transverse direction (Y) due to the absence of a high beam transverse to the corridors that would have given continuity to the RC frames. Considering the results of the worst case (modal) configuration, the stiffness is 98'990 kN/m in the longitudinal direction and 75'852 kN/m in the transverse direction.
- The C/D ratios in term of maximum collapse acceleration ($a_{g,c}$) indicate that the modal force distributions are more demanding with a vulnerability of around 74% for the longitudinal direction and 57% for the transverse direction.

5.1.2 Project state, application of the steel exoskeleton

The steel exoskeleton was evaluated to increase the performance of the existing structure in terms of strength and stiffness, improving the performances against frequent earthquakes by reducing global and interstorey displacements. In addition, the performance in terms of overall capacity and strength of the existing elements (with regards to the linear dynamic analysis, force-based design) is expected to be improved. However, as reported in Chapter 4, this strategy should be carefully assessed because, while it increases capacity and stiffness, it may also increase demand reducing the fundamental period.

The external structure foreseen in the project solution consists of a steel frame (two columns and a beam) for each floor, with bracing in the transverse direction, connected to the existing RC frame at the column-beam joints. These rigid frames, acting as shear walls, increase the stiffness of the existing RC frames towards the seismic action acting in plane of the frames; the connection of these external frames in longitudinal direction creates additional space at each level of the existing structure.

In this section the improvement given by the application of this strategy is presented, by varying a critical aspect of the intervention: the connection with the existing RC frames. The structure of the chapter follows the previous one, introducing the information about the new steel structures, the consequent results and eventually comparing them with the initial state.

5.1.2.1 Materials

S275 grade steel was used for all the structural elements constituting the exoskeleton, with the sole exception of the diagonal bracing. S235 steel was used for these profiles in order to respect the strength hierarchy for braced frame structures and to entrust the dissipative capacity to the diagonal element subjected to tensile stress. Table 40 shows the mechanical parameters of the steel grades used in the model.

Table 40 – Mechanical parameters of the steel grades provided in the new external structures – Source: [131]

Steel Grade	$f_{yk}(MPa)$	$f_{tk}(MPa)$	$f_{yd}(MPa) = \frac{f_{yk}}{\gamma_s}$	$f_{td}(MPa) = \frac{f_{tk}}{\gamma_s}$	$E(MPa)$	$G(MPa)$	ν
S275 (t≤40 mm)	275	430	261.9	409.5	210'000	80'000	0.3
S235 (t≤40 mm)	235	360	223.8	342.8	210'000	80'000	0.3

- E - modulus of elasticity
- G - shear modulus
- ν - Poisson coefficient
- f_{yk} - characteristic value of yield strength of steel
- f_{tk} - characteristic value of ultimate strength of steel
- γ_s - partial factor for reinforcement steel, used for the linear dynamic analyses
- f_{yd} - design value of yield strength of steel
- f_{td} - design value of ultimate strength of steel

5.1.2.2 Structural scheme and characterisation of the members

The schemes of the structure used in the structural strengthening of the case study are shown below (Figure 85 and Table 41). The exoskeleton is applied on the three available sides of the perimeter. The proximity of the other part of the building on the south side of the structure does not allow the external structures to be continuous around the interested block. The application of the external structure on this case study must be preceded by the removal of the balconies around the building. This procedure is advantageous since it allows a reduction of vertical and torsional loads on the building by homogeneously distributing the mass; however,

at the same time it is delicate since it changes the static scheme and the anchorages of the existing reinforcements in the RC slabs and must be accompanied by a local evaluation of the structural details. These two points are translated in an asymmetric extension with respect to the Y axis (Figure 85a).

By means of the modal dynamic analysis, the stiffness of the new steel frames is therefore adjusted so as not to generate additional torsional motions, but rather to correct the order of the vibration modes by avoiding torsional components in the first two vibration modes.

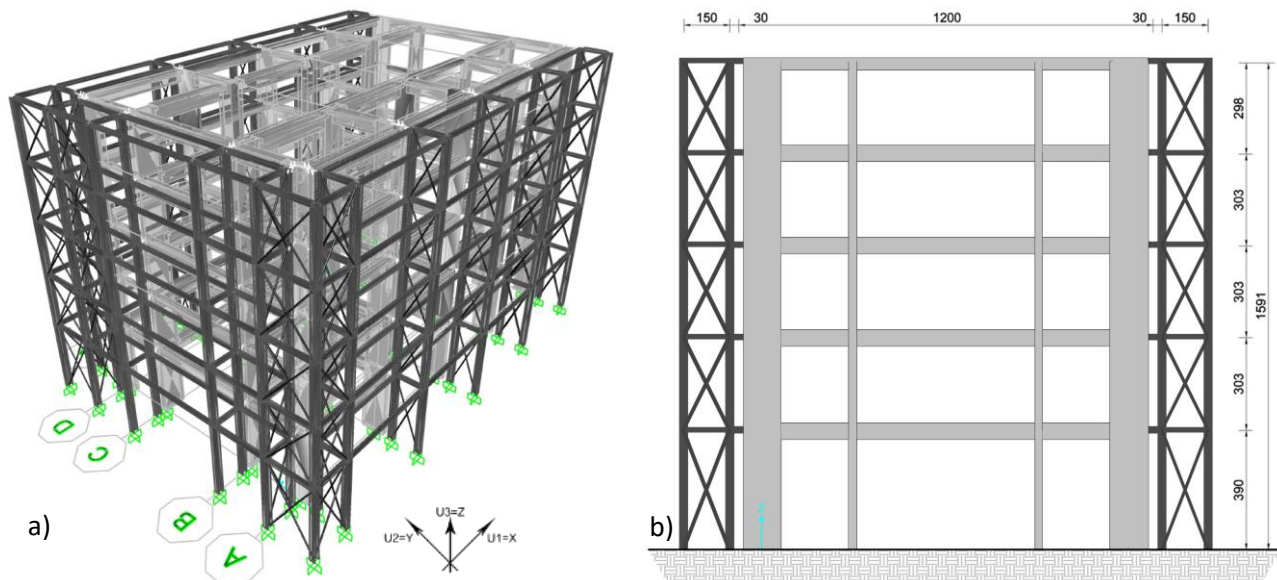

Figure 85 – a) Panoramic view of the finite element model of the application of the exoskeleton on the north part of the Athens case study; b) elevation scheme of the exoskeleton in the first RC frame (cm as units)

Table 41 – Profiles of the steel elements

Structural element	Cross-section (HL)	Cross-section (RL)	Steel Grade
Columns	HEA280	HEA280	S275
Transverse Beams	HEA160	HEA160	S275
Longitudinal Beams	HEB140	HEB140	S275
Bracing pipes	$\phi 76.1 \times 3.2$	$\phi 76.1 \times 3.2$	S235
Bracing pipes in RSF	$\phi 114.3 \times 7$	$\phi 114.3 \times 7$	S235
Connections profiles	Hinge Connection	HEA180; HEA200	S275
Connections profiles	Hinge Connection	HEA180; HEA200; HEA240	S275

The steel shear walls consist of columns, beams, and braces design to be welded in the workshop and assembled on site, taking into account the height limitation due to transport. The drawings and details of the preliminary design are further described in Section 5.1.5.

These steel shear walls contribute to the seismic actions in both directions, while along the longitudinal direction, parallel to the façades of the existing structure, longitudinal pinned beams are provided to support the volumetric technological units of the integrated system. The bracing of the extreme spans (in the free corners) avoids relative movements in the longitudinal direction of the steel frames since no constraints are applied in the outer floors.

Due to the asymmetry mentioned above, in order to avoid torsional components, it was decided to stiffen two steel frames (RSF) close to the seismic joint (south side). As a consequence, the first two vibration modes resulted translational (as shown in the modal analysis results). A simplified scheme to describe the structural configuration is shown in Figure 86. HEA280 were provided for the columns and HEA160 for the horizontal transverse beams. To support the vertical loads, HEB140 profiles were used for each span. The bracing was $\phi 76.1 \times 3.2$ tubular profiles except for the reinforced steel frame (RSF) where $\phi 114.3 \times 7$ was used.

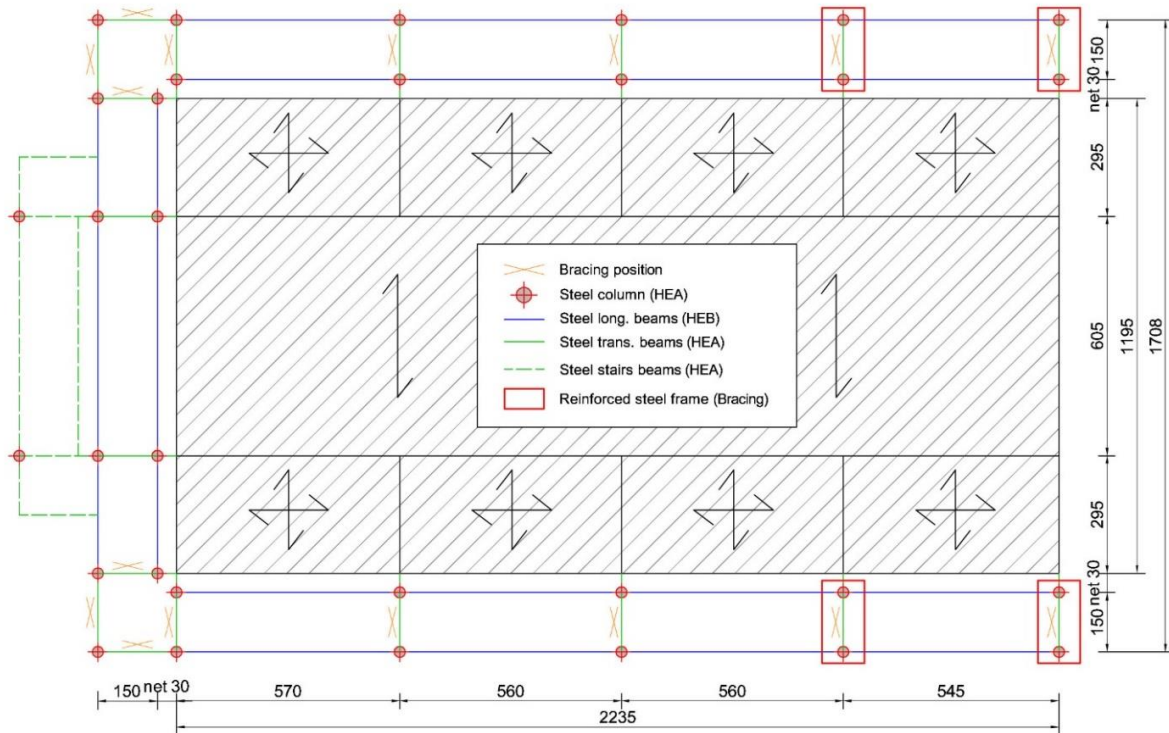

Figure 86 – Planimetric scheme of the exoskeleton identifying the profiles used and indicating the positions of the bracing (cm as units)

A depth of 1500 mm was proposed for the exoskeleton from architectural requirements. Considering the overhang of the foreseen prefabricated floors, it guarantees an extension that does not cause significant problems for the internal lighting. Furthermore, in addition to the structure of the exoskeleton, as indicated in the scheme (Figure 87) and in the attached drawings in the Appendix, an additional external staircase, directly connected to the new structural system was planned and verified on the north side. All the hypotheses examined in this chapter include this staircase in the models as shown in Figure 87b (in order to better show the structure of the exoskeleton the stairs have occasionally been hidden from the pictures).

The connection between the two structures is the investigated variable in Chapter 5.1.2 where two identical configurations with different connection types are evaluated. The first option involves a rotational hinge that releases the moment in the plane of the shear walls and aims to reduce the stresses transferred between the two structures. This solution is identified as HL (hinged link) in the chapter and is also foreseen in the presented preliminary design (Section 5.1.5). The hinged link is modelled through a multi-linear spring that provides fixations for all the degree of freedom except rotation in the vertical plane orthogonal to the existing façade (M3).

The second option identified as RL (rigid link) provides a rigid connection between the two structures by means of a steel profile connected on both structures. HEA profiles (Table 41) were chosen to guarantee the collaboration between the two structures in both directions and modelled using a frame element between the two structures.

5.1.2.3 Modelling parameters

Load patterns

As presented in Chapter 7, the architectural units are divided into three types: balcony, sun space and extra room. The intention of the project is to allow users the freedom to customise their living space by choosing between these types according to their economic availability or simply aesthetics. Consequently, in the

structural analysis, it was decided to apply the greatest load, characteristic of the extra-room on all the spans of the exoskeleton. The stratigraphy of floors and external partitions is defined from intrados to extrados as follow.

- Extra room floor: 50 mm ceiling solid wood panel (0.3 kN/m²), 180 mm mineral wool insulation (0.144 kN/m²), 90 mm cross-laminated timber panel (0.54 kN/m²), 36 mm of two gypsum boards (0.14 kN/m²), and 9 mm of finishing floor (0.054 kN/m²).
- External timber-frame walls: 50 mm of plastered and mineral wool based ETIC-system (0.15 kN/m²), 140 mm mineral wool insulation within timber framework 140x60 mm (0.14 kN/m²), 12 mm OBS panel (0.078 kN/m²), and 12.5 mm plastered board (0.1 kN/m²).

The following tables show the loads considered in the model (Tables 42-44). The categories selected for imposed and snow loads refer to the Eurocode 1 [134, 135]. The balcony live load has been used for all the external units as the most conservative. Therefore, surface loads were applied on the new areas within the exoskeleton (supported by the HEB beams).

Table 42 – Load patterns assigned to the floors of the extensions – Source: [134, 135]

CLT floors			
	Self-weight	Dead load	Live load
n floor	0.540 kN/m ²	0.633 kN/m ²	Balcony = 4 kN/m ²
Roof floor	0.540 kN/m ²	0.633 kN/m ²	Snow = 0.34 kN/m ²

Table 43 – Load patterns assigned to the external stairs – Source: [135]

Stairs		
Self-weight	Dead load	Live load
–	"No panic" gratings = 0.6 kN/m ²	Common stairs = 4 kN/m ²
–	Railing = 0.2 kN/m	

The external partitions were included as additional linear load to be applied on the external beams.

Table 44 – Load patterns of the external partitions

Extra rooms partitions		
Self-weight	Dead load	Live load
–	External partition = 1.24 kN/m	–

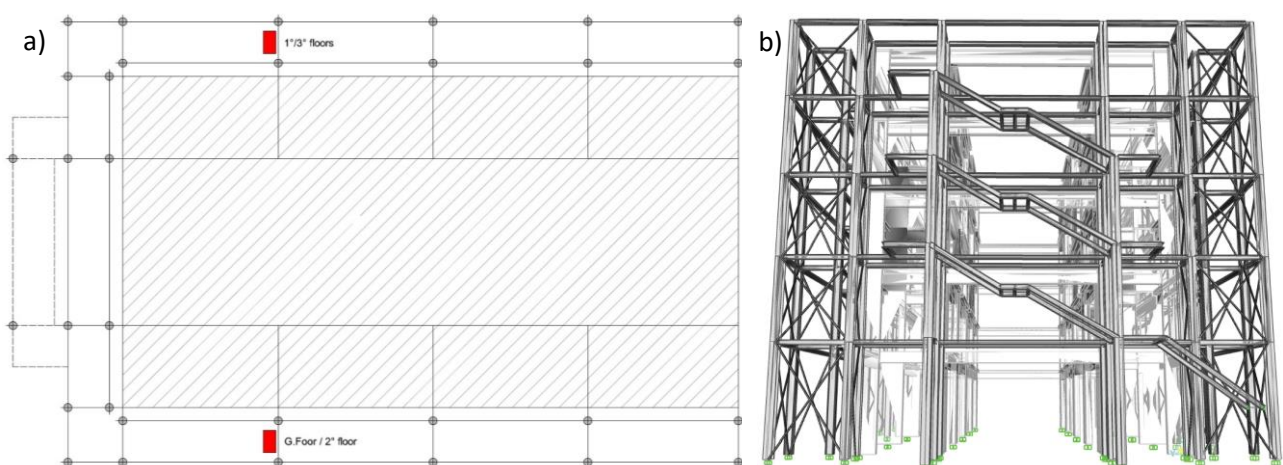

Figure 87 – a) Positioning of the ELFOpack system on the new addition; b) picture of the structure of the stairs from the FEM software

Finally, the loads due to the most impactful system components were included. The integrated system involves the installation of a single machine for air conditioning of the entire flat. The machine has a considerable weight of 400 kg due to the presence of a tank of water. This additional load was placed in the steel extension, following the current architectural design, providing one machine per floor, located on opposite sides (west and east) as shown in Figure 87a.

Restraints/Constraints

Given the concept of floor prefabrication characterised by a rapid assembly phase, as a precautionary measure no diaphragm constraints were applied to the joints belonging to the steel exoskeleton.

In addition, in line with the choice for the initial state assessment, the foundations were not modelled, and restraints were provided, fixing all six degrees of freedom.

Response spectrum functions and q-factors

The horizontal elastic response spectra are the same as those considered in the previous section. The design response spectrum considered in the linear dynamic analysis depends on the behaviour factor q . The nonlinear analysis carried out in parallel allowed the exploitation of the exoskeleton to be verified and the behaviour factor (q) for the linear analysis can be increased considering the plasticisation of the new steel structure. The new distribution of masses and stiffnesses made it possible to eliminate the 20% reduction of the q -factor [12] and brought the value K_r of (5.2) to 1.0. Together with the increase of the overstrength ratios higher q -factor values were deduced from the capacity curves obtained from the non-linear static analysis. Table 45 shows the minimum values calculated and used in the analyses.

Table 45 – q-factor values for the project state with hinged (HL) and rigid (RL) connections

LS Significant Damage	q – Initial state	q – Project state (RL)	q – Project state (HL)
Pushover analysis in longitudinal direction (X)	3.01	4.00	3.88
Pushover analysis in transverse direction (Y)	2.84	3.59	4.26
Verification for brittle failures	1.50	1.50	1.50

The increase in capacity and stiffness is linked to a reduction in displacements, which leads to an increase in both the numerator and the denominator for the calculation of the global overstrength factor. Considering the contribution given by the new regularity, the application of the exoskeleton makes it possible, through the dissipation of its members, to increase the q -factors in both directions: in longitudinal direction (X) from 3.01 to 4.00, and from 2.84 to 3.59 in the transverse direction (Y) for the project solution with rigid connections (RL). For the solution with hinged connections, values of 3.88 and 4.26 were reported for X and Y respectively. The increase of the q -factor, together with a new stress distribution in the existing structural elements and the reduction of additional torsional components are the approaches to achieve the seismic improvement with force-based design analysis.

Plastic hinges

In order to perform the static non-linear analysis, the non-linear behaviour of all resistant elements involved in the analyses was defined. Beams and columns were modelled as nonlinear frame elements with lumped plasticity by defining plastic hinges at both ends of the elements. The hinge properties for steel members are based on Table 5-6 of FEMA-356 [146] and are in accordance with the values given in Annex B of Eurocode 8-Part 3 [11] for ductile mechanisms. They can identify the performance levels for each step of the non-linear

static analysis. As an example, Table 46 shows the values of plastic rotation capacity at the end of beams or columns with dimensionless axial load v not exceeding 0.30 with direct reference to [11].

Table 46 – Plastic rotation capacity at the end of beams or columns with dimensionless axial load v not greater than 0.30 – Source: Table B.1 [11]

Class of cross section	Limit State		
	DL (IO in FEMA-356)	SD (LS in FEMA-356)	NC (CP in FEMA-356)
1	$1.0 \theta_y$	$6.0 \theta_y$	$8.0 \theta_y$
2	$0.25 \theta_y$	$2.0 \theta_y$	$3.0 \theta_y$

Considering a yield rotation calculated as the chord rotation along the entire length of the member due to the plastic moment at one end. In particular, the yield rotation (θ_y) is calculated by the software as follows:

$$\theta_y = \frac{M_p}{W} \quad (5.12)$$

where

- $M_p = Z \cdot f_y$ - moment capacity of the frame at the location of the plastic hinge;
- $W = 6EI/L$ - section modulus;
- Z - effective plastic modulus of the section at the plastic hinge location;
- f_y - yield strength of the steel in the elements.

Therefore, the behaviour of these hinges depends on the cross-section of the element, the material properties, and the axial loads calculated with a QP-combination of vertical loads. SAP2000 [129] provides default-hinge properties. PMM (combined bending and axial loads) hinges for columns and M3 (only bending loads) hinges for beams were assigned.

In the same way plastic hinges for bracing were provided with reference to Table 5-7 of FEMA-356 [146], complying with Tables B.2 and B.3 of Eurocode 8 – Part 3 [11] and automatically inserted in the middle of every diagonal bracing.

Displacement controlled non-linear hinges, placed at the ends of steel beams and columns and in the middle of the diagonal bracing are:

- M3 for beams – Bending failure condition
- P-M2-M3 for columns – Combined axial and bending failure condition (axial loads from QP)
- P for diagonal bracing – Axial failure condition

5.1.2.4 Results

Modal analysis

The following are the results of the first four vibration modes after application of the steel exoskeleton (Table 47 and 48). As shown by the participating masses and in Figure 88, the application of the exoskeleton allows to adjust the dynamic behaviour, avoiding torsional components in the first two vibration modes. While the project solution HL required two RSFs on the south side (as presented above), for RL project solution only the last frame had to be reinforced.

Furthermore, it is possible to notice that the increased number of steel shear walls in the transverse direction led the vibration mode along Y-axis to the second position due to increased stiffness.

Table 47 – Results of the modal analysis of the project solution with hinged connections; periods are expressed in seconds while participating masses are percentages of the total mass of the building

Project Solution – HL				
Mode	Period (s)	Participating Mass		
		U1	U2	RZ
1	0.643	85.74%	≈ 0	≈ 0
2	0.585	≈ 0	84.91%	≈ 0
3	0.564	≈ 0	0.05%	84.47%
4	0.271	≈ 0	0.03%	0.09%

Table 48 – Results of the modal analysis of the project solution with rigid connections; periods are expressed in seconds while participating masses are percentages of the total mass of the building

Project Solution – RL				
Mode	Period (s)	Participation Mass		
		U1	U2	RZ
1	0.656	85.66%	≈ 0	≈ 0
2	0.572	≈ 0	84.97%	≈ 0
3	0.558	≈ 0	≈ 0	84.10%
4	0.273	≈ 0	0.04%	0.14%

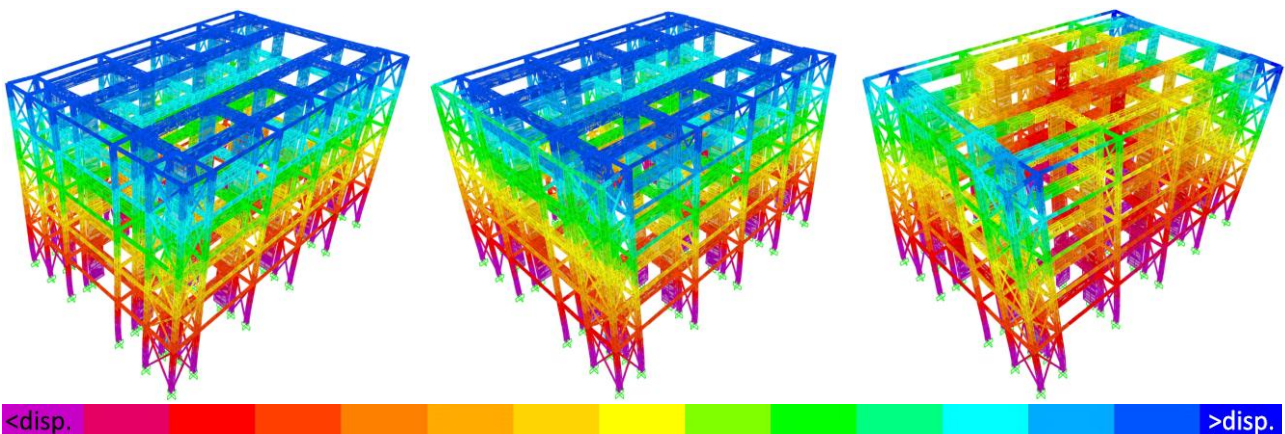

Figure 88 – Representation of the first three main vibration modes in ascending order from left to right for the project solution (RL); the displacements increase from purple to blue

Linear dynamic analysis

The values of the maximum displacements of the same nodes of the previous section are shown in Table 49. In addition, the relative percentages of variations at the LS DL are reported.

Table 49 - Maximum displacements calculated with the linear dynamic analysis for both main directions (X and Y) for the project solutions with hinged (HL) and rigid connections (RL)

Athens case study	Project solution – HL		Project solution – RL	
LS DL	U1 (mm)	U2 (mm)	U1 (mm)	U2 (mm)
δ_{max} (Roof)	53.0	51.6	53.7	51.1
-Δ-	17.1%	32.3%	16.0%	32.9%

It can be seen that in terms of maximum top-displacements the reduction in transverse direction is around 33%, and 16% in longitudinal directions, with similar values for both solutions.

The vulnerability analysis was then carried out in terms of maximum stresses in the structural elements and interstorey displacements as described in Section 5.1.1.4. The vulnerability assessment carried out with dynamic linear analysis (force-based design) for LS SD was found to be satisfied with higher percentages of the design seismic loads (Table 50).

Table 50 – Seismic vulnerability assessment with linear dynamic analysis

Vulnerability assessment with linear dynamic analysis – LS SD	
Project solution – HL	Project solution – RL
$85\% \leq E(a_g)_{LS\ SD} \leq 90\%$	$80\% \leq E(a_g)_{LS\ SD} \leq 85\%$

The improvement is quantified at about 45% of the design seismic action and is related to the reduction of the torsional components, a new distribution of internal stresses, and a reduction of seismic loads due to the increase of behaviour factors. The variation of the connection between the existing structure and the steel exoskeleton showed a difference of 5% and is probably caused by the q-factor values used in the analyses.

With regard to the verifications of the interstorey drift, a graph representing the drifts of the more flexible RC moment resisting frame is shown below in Figure 89. The related vulnerability assessment to the LS DL is then reported in Table 51.

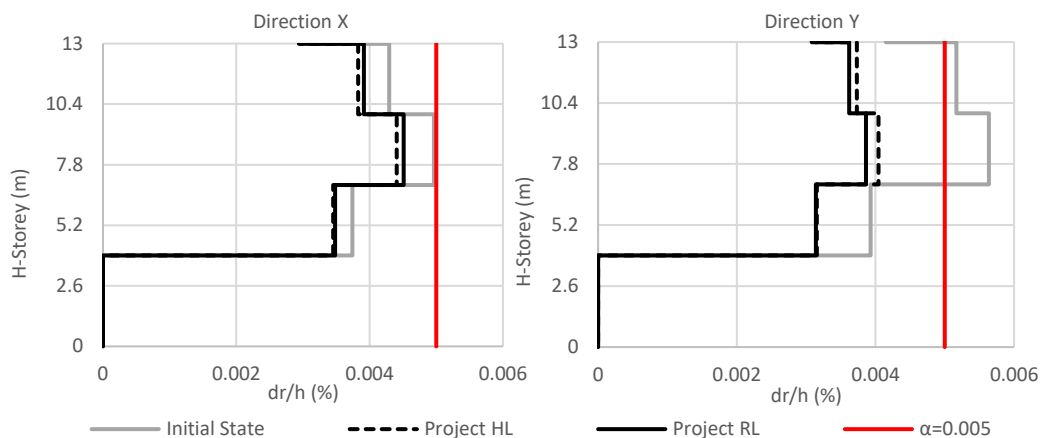

Figure 89 – Interstorey drift verification for the project states (HL and RL) of the Athens case study for both main direction at the LS DL; the values are compared to the requirement for buildings having non-structural elements of brittle materials

Table 51 – Seismic vulnerability assessment with linear dynamic analysis

Vulnerability assessment with linear dynamic analysis – LS DL	
Project solution – HL	Project solution – RL
$E(a_g)_{LS\ DL} = 113\%$	$E(a_g)_{LS\ DL} = 111\%$

The interstorey drift verification was satisfied in both design solutions, without relevant differences, passing from a vulnerability value of 89% to 111%, confirming the simplified results of Table 50.

Verifications of the exoskeleton

The verifications on the structural members of the exoskeleton were carried out by means of the design software. The strength and deformability checks were carried out considering the ultimate limit states (LS SD and ULS) and the operational limits (LS DL and SLS) respectively. The software complies with the European technical standards required for the verification of the steel members, Eurocode 3 and 8 [12, 131]. For a complete overview of the procedures provided by the software, reference is made to the software design manuals (SAP2000 [129]).

Non-linear static analysis (pushover)

The results of the modal analysis show a regular behaviour of the structure with the first two vibration modes not presenting torsional components with percentages of participating masses greater than 84% for both directions and project solutions. Once all analyses have been carried out for both design solutions (HL and RL), the reference parameters described in Section 5.1.1.4 have been derived.

Project state, Athens case study (uniform force distribution – X)

Figure 90 – Representation of the capacity curves for both MDOF and SDOF systems and relative bilinearisation of the SDOF curve with the use of the parameters reported on the right; uniform force distribution along X-direction for the HL project solution

Table 52 – Pushover analysis results; uniform force distribution along X-direction

Assessment results – LS Damage Limitation	Hinged Joints	Rigid Joints
Displacement demand (D)	48.70 mm	49.86 mm
Displacement capacity (C)	53.80 mm	53.29 mm
D/C Ratio	90.5%	93.6%
K_{60}	143'825 kN/m	136'547 kN/m
Total shear capacity - V_{\max}	6'750 kN	6'573 kN
$S_e(T)$	0.354 g	0.344 g
$a_{g,c}$	0.355 g	0.346 g
C/D Ratio	100%	100%
Assessment results – LS Significant Damage	Hinged Joints	Rigid Joints
Displacement demand (D)	61.84 mm	63.31 mm
Displacement capacity (C)	104.80 mm	109.30 mm
D/C Ratio	59.0%	57.9%
K_{60}	143'825 kN/m	136'547 kN/m
Total shear capacity - V_{\max}	8'567 kN	8'330 kN
$S_e(T)$	0.450 g	0.436 g
$a_{g,c}$	0.451 g	0.438 g
C/D Ratio	100%	100%
Assessment results – LS Near Collapse	Hinged Joints	Rigid Joints
Displacement demand (D)	108.53 mm	111.13 mm
Displacement capacity (C)	119.80 mm	123.70 mm
D/C Ratio	90.6%	89.8%
K_{60}	143'825 kN/m	136'547 kN/m
Total shear capacity - V_{\max}	8'915 kN	8'680 kN

$S_e(T)$	0.790 g	0.766 g
$a_{g,c}$	0.469 g	0.457 g
C/D Ratio	60%	60%

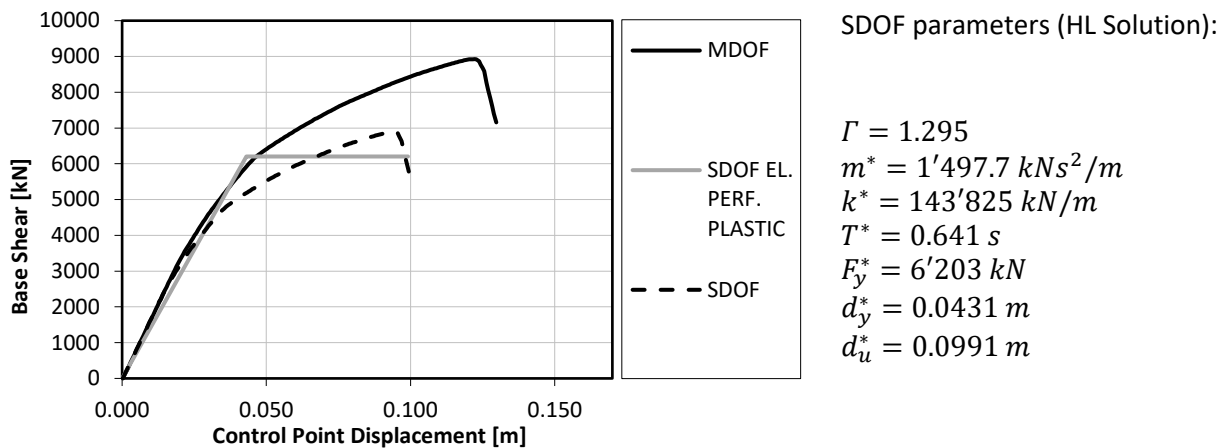
Project state, Athens case study (modal force distribution – X)

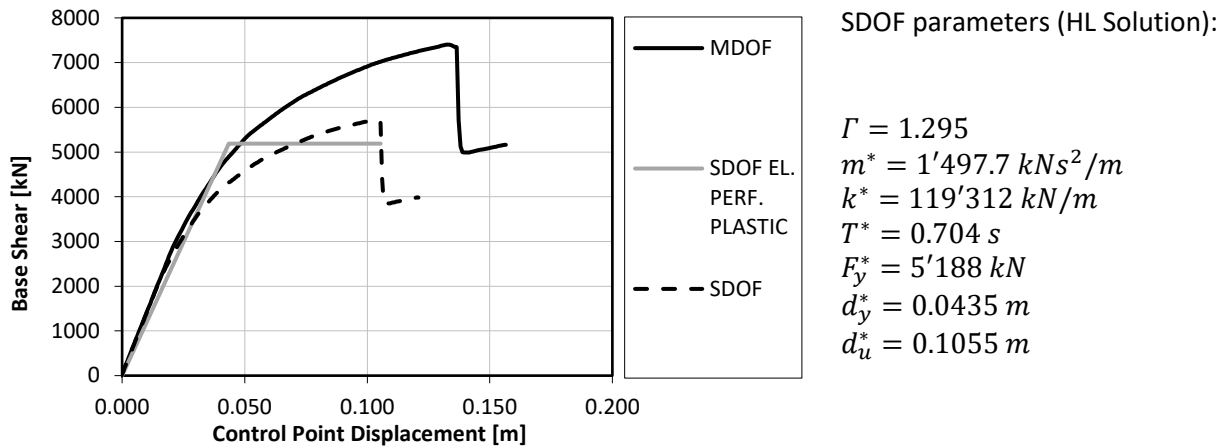

Figure 91 – Representation of the capacity curves for both MDOF and SDOF systems and relative bilinearisation of the SDOF curve with the use of the parameters reported on the right; modal force distribution along X-direction for the HL project solution

Table 53 – Pushover analysis results; modal force distribution along X-direction

Assessment results – LS Damage Limitation	Hinged Joints	Rigid Joints
Displacement demand (D)	52.65 mm	53.76 mm
Displacement capacity (C)	59.61 mm	60.15 mm
D/C Ratio	88.3%	89.4%
K_{60}	119'312 kN/m	111'955 kN/m
Total shear capacity - V_{max}	5'721 kN	5'495 kN
$S_e(T)$	0.354 g	0.344 g
$a_{g,c}$	0.301 g	0.289 g
C/D Ratio	85%	84%
Assessment results – LS Significant Damage	Hinged Joints	Rigid Joints
Displacement demand (D)	66.85 mm	68.26 mm
Displacement capacity (C)	98.91 mm	121.09 mm
D/C Ratio	67.6%	56.4%
K_{60}	119'312 kN/m	111'955 kN/m
Total shear capacity - V_{max}	6'892 kN	7'084 kN
$S_e(T)$	0.450 g	0.436 g
$a_{g,c}$	0.362 g	0.373 g
C/D Ratio	81%	85%
Assessment results – LS Near Collapse	Hinged Joints	Rigid Joints
Displacement demand (D)	117.34 mm	119.81 mm
Displacement capacity (C)	98.91 mm	136.68 mm
D/C Ratio	118.6%	87.7%
K_{60}	119'312 kN/m	111'955 kN/m
Total shear capacity - V_{max}	6'892 kN	7'318 kN
$S_e(T)$	0.790 g	0.766 g
$a_{g,c}$	0.362 g	0.385 g
C/D Ratio	46%	50%

Project state, Athens case study (uniform force distribution – Y)

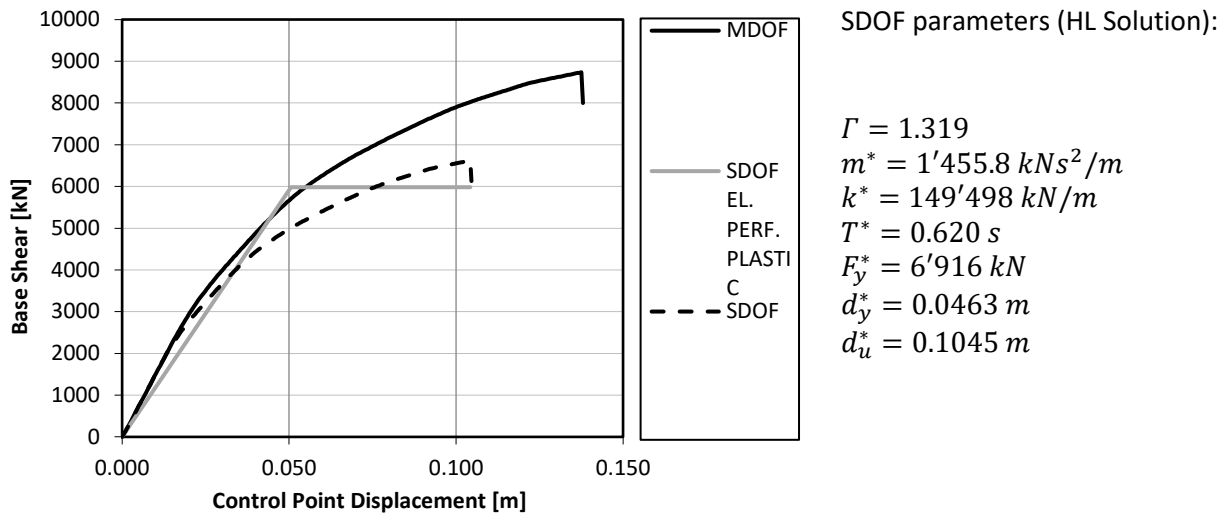

Figure 92 – Representation of the capacity curves for both MDOF and SDOF systems and relative bilinearisation of the SDOF curve with the use of the parameters reported on the right; uniform force distribution along Y-direction for the HL project solution

Table 54 – Pushover analysis results; uniform force distribution along Y-direction

Assessment results – LS Damage Limitation	Hinged Joints	Rigid Joints
Displacement demand (D)	48.01 mm	44.35 mm
Displacement capacity (C)	50.25 mm	58.53 mm
D/C Ratio	95.5%	75.8%
K_{60}	149'498 kN/m	172'956 kN/m
Total shear capacity - V_{max}	6'833 kN	7'925 kN
$S_e(T)$	0.391 g	0.398 g
$a_{g,c}$	0.363 g	0.420 g
C/D Ratio	93%	100%
Assessment results – LS Significant Damage	Hinged Joints	Rigid Joints
Displacement demand (D)	60.96 mm	56.32 mm
Displacement capacity (C)	95.24 mm	86.55 mm
D/C Ratio	64.0%	65.1%
K_{60}	149'498 kN/m	172'956 kN/m
Total shear capacity - V_{max}	9'171 kN	9'464 kN
$S_e(T)$	0.497 g	0.505 g
$a_{g,c}$	0.487 g	0.502 g
C/D Ratio	98%	99%
Assessment results – LS Near Collapse	Hinged Joints	Rigid Joints
Displacement demand (D)	106.90 mm	98.85 mm
Displacement capacity (C)	95.24 mm	86.55 mm
D/C Ratio	112.3%	114.2%
K_{60}	149'498 kN/m	172'956 kN/m
Total shear capacity - V_{max}	9'171 kN	9'464 kN
$S_e(T)$	0.872 g	0.887 g
$a_{g,c}$	0.487 g	0.502 g
C/D Ratio	56%	57%

Project state, Athens case study (modal force distribution – Y)

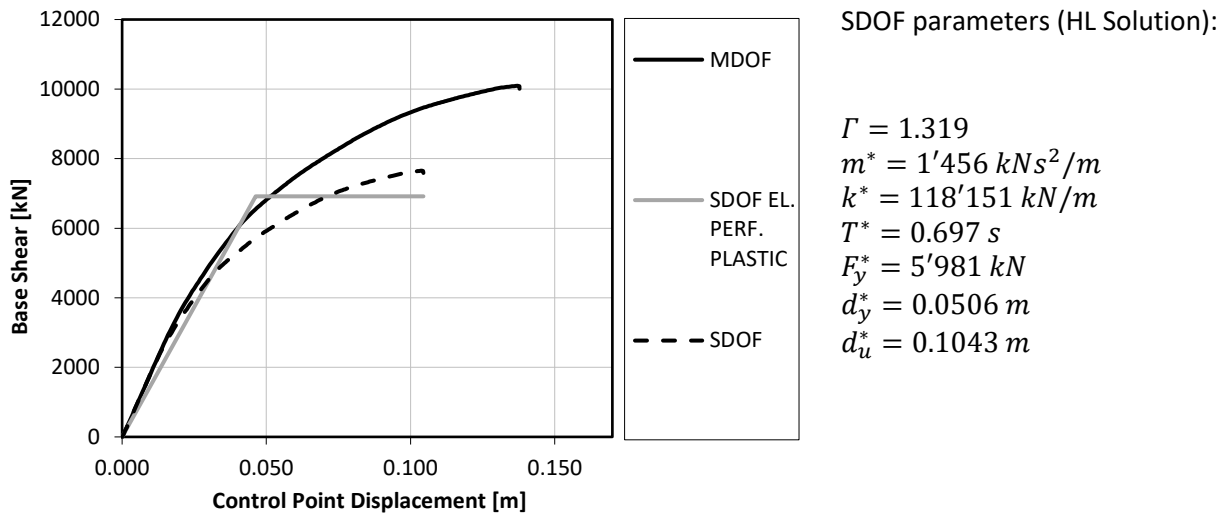

Figure 93 – Representation of the capacity curves for both MDOF and SDOF systems and relative bilinearisation of the SDOF curve with the use of the parameters reported on the right; modal force distribution along Y-direction for the HL project solution

Table 55 – Pushover analysis results; modal force distribution along Y-direction

Assessment results – LS Damage Limitation	Hinged Joints	Rigid Joints
Displacement demand (D)	53.28 mm	50.48 mm
Displacement capacity (C)	57.85 mm	61.73 mm
D/C Ratio	92.1%	81.8%
K_{60}	118'151 kN/m	134'396 kN/m
Total shear capacity - V_{max}	6'150 kN	6'821 kN
$S_e(T)$	0.391 g	0.398 g
$a_{g,c}$	0.326 g	0.362 g
C/D Ratio	84%	91%
Assessment results – LS Significant Damage	Hinged Joints	Rigid Joints
Displacement demand (D)	67.65 mm	64.12 mm
Displacement capacity (C)	101.05 mm	95.44 mm
D/C Ratio	67.0%	67.2%
K_{60}	118'151 kN/m	134'396 kN/m
Total shear capacity - V_{max}	7'932 kN	8'297 kN
$S_e(T)$	0.497 g	0.505 g
$a_{g,c}$	0.421 g	0.440 g
C/D Ratio	85%	87%
Assessment results – LS Near Collapse	Hinged Joints	Rigid Joints
Displacement demand (D)	118.75 mm	112.52 mm
Displacement capacity (C)	101.05 mm	95.44 mm
D/C Ratio	117.5%	117.9%
K_{60}	118'151 kN/m	134'396 kN/m
Total shear capacity - V_{max}	7'932 kN	8'297 kN
$S_e(T)$	0.872 g	0.887 g
$a_{g,c}$	0.421 g	0.440 g
C/D Ratio	48%	50%

5.1.2.5 Result comparison and final quantities

A comparison of the parameters introduced in Section 5.1.2.4 is reported, concerning the results of the non-linear static analysis. It can be noted that the strengthening provided by the steel external structure is significant in relation to the seismic demand, as already shown by the results from the linear dynamic analysis. Furthermore, a preliminary impact in terms of weight and costs of the structure is presented.

Non-linear static analysis – results comparison

In order to evaluate the strengthening intervention by means of external steel shear walls applied perpendicularly to the existing façades, the set of parameters introduced in Section 5.1.2.4 was compared before and after the application of the exoskeleton.

- TDVs were carried out with reference to Annex B of [12]. The ratios of demand to capacity (D/C) must remain below 100%. For the initial state, the results were verified for all limit states except for the damage limitation in the transverse direction (Y), where a value of 129% was reported. A weakness towards frequent earthquake is therefore evidenced by this vulnerability in accordance with the interstorey verifications for the linear dynamic analysis. Although a good inelastic behaviour of the structure is recorded, the evaluation is partially compromised by the torsional behaviour that usually led to non-conservative results related to a reduction of the participating mass in the direction of the seismic loads or the neglect of torsional effects that may compromise the outermost elements. In the project solutions this ratio was verified in all combination, resolving the damage limitation vulnerability (the worst D/C values are 95.5% and 93.6% for the HL and RL project solutions respectively), but reducing the performance at LS NC due to a reduced displacement capacity of more than the demanded value and reaching D/C ratios of 119% (84% of the design seismic load at LS NC) for the HL solution and 118% for the RL. To further investigate the impact of the exoskeleton at LS NC, non-linear dynamic analyses were performed with results presented in Section 5.1.4.
- Considering the results of the worst case (modal) configuration, the stiffness of the structure increased from 98'990 kN/m to 119'312 kN/m (Δ_{increase} of 1.21) in the longitudinal direction and from 75'852 kN/m to 118'151 kN/m ($\Delta_{\text{inc.}}$ of 1.56) in the transverse direction for the HL project solution. The latter solution resulted stiffer in the longitudinal direction but not for the transverse direction. The resulting stiffness of the RL solution is in fact 111'955 kN/m ($\Delta_{\text{inc.}}$ of 1.13) along X and 134'396 kN/m ($\Delta_{\text{inc.}}$ of 1.77) along Y.
- The C/D ratios in term of simplified maximum collapse acceleration ($a_{g,c}$) record the increase in strength directly linked to the entity of the lateral forces, taking into account the increase in demand due to the reduction of the natural periods on the elastic response spectra (this parameter neglects the contribution given by the progressive damage of the structure and the consequent dissipation of energy). The exoskeleton made it possible to increase the collapse acceleration for all the performance levels analysed. With reference to the LS SD and considering the modal distribution of the forces (as worst case), it is possible to notice that with the application of the external exoskeleton, an increase in $a_{g,c}$ from 74% to 81-85% occurs along the longitudinal direction and from 57% to 85-87% in the transverse direction. These results are similar and comparable to what was obtained with the linear dynamic analysis.

Exploitation of the exoskeleton

With the aim of assessing the exploitation of the exoskeleton, the part of horizontal force taken by the exoskeleton is extrapolated and compared with the total action. The values are derived from pushover analyses with modal force distribution (as the worst case) and in relation to the limit states defined by the standards (Tables 56 and 57).

Table 56 – Exploitation of the exoskeleton in terms of horizontal forces; calculated at the steps of the pushover analysis corresponding to the interested LS with modal force distribution for the HL project solution

Athens case study – Project solution HL				
PUSH-X Mode	Total Shear (kN)	Existing Structure (kN)	Steel Exoskeleton (kN)	Exploitation (%)
LS DL	5'721	4'568	1'153	20.2%
LS SD	6'892	5'023	1'869	27.1%
LS NC	Coincides with the LS SD			
PUSH-Y Mode	Total Shear (kN)	Existing Structure (kN)	Steel Exoskeleton (kN)	Exploitation (%)
LS DL	6'150	3'868	2'282	37.1%
LS SD	7'932	4'055	3'877	48.9%
LS NC	Coincides with the LS SD			

Table 57 – Exploitation of the exoskeleton in terms of horizontal forces; calculated at the steps of the pushover analysis corresponding to the interested LS with modal force distribution for the RL project solution

Athens case study – Project solution RL				
PUSH-X Mode	Total Shear (kN)	Existing Structure (kN)	Steel Exoskeleton (kN)	Exploitation (%)
LS DL	5'496	4'598	897	16.3%
LS SD	7'084	5'300	1'784	25.2%
LS NC	7'318	5'400	1'918	26.2%
PUSH-Y Mode	Total Shear (kN)	Existing Structure (kN)	Steel Exoskeleton (kN)	Exploitation (%)
LS DL	6'821	4'669	2'152	31.5%
LS SD	8'297	5'176	3'121	37.6%
LS NC	Coincides with the LS SD			

As can be seen from these results, the exploitation of the exoskeleton is around 30% in longitudinal direction and around 40-50% in the transverse direction. These values allow to determine the percentage of collaboration between the existing and the new structures and proved that the solution with hinged connection allow to take more horizontal forces. The greater exploitation of the exoskeleton with hinge connections, together with substantially similar results from the seismic analyses carried out, and the desire to transfer as less stresses as possible to the existing structures, dictated the choice of the hinge connection.

On the other hand, the exploitation results show that the failure of the strengthened solution jump from damage limitation to near collapse LS (not determining the collapse of the structure, since the passage of LS is linked in these analyses to only one non-linear hinge passing the limit) without indicating a non-ductile behaviour.

Capacity curves comparison

The capacity curves obtained through non-linear static analyses are shown below for both the main directions. The coordinates corresponding to the exceeding of the limit states of DL and SD are also indicated for each curve. The capacity curves in Figures 94 and 95 show how the application of the steel extension leads to an increase in strength and stiffness, which results in higher values of $a_{g,c}$, better performance against frequent earthquakes and reduced displacement capacities that must be carefully assessed.

Assuming that the target displacement verifications for the LS SD are all satisfied (main requirement of the standards [11]), two considerations are reported. Along the longitudinal direction, where the exoskeleton is less incisive, the displacement capacity is still dictated by the existing structure and the displacement capacities are mostly aligned. In the transverse direction the increase in capacity at the LS DL, and the strong impact of the exoskeleton, reduce the displacement at the LS SD due to a premature failure of the structural elements at the ground floor and indicate margins of optimisation for the external structure. This fact translates into TDVs with fulfilment of the LS DL requirements at the expense of inelastic

deformations in the existing members which would allow greater energy dissipation and a possible improved behaviour against rare earthquakes, characterised by acceleration values typical of the LS NC.

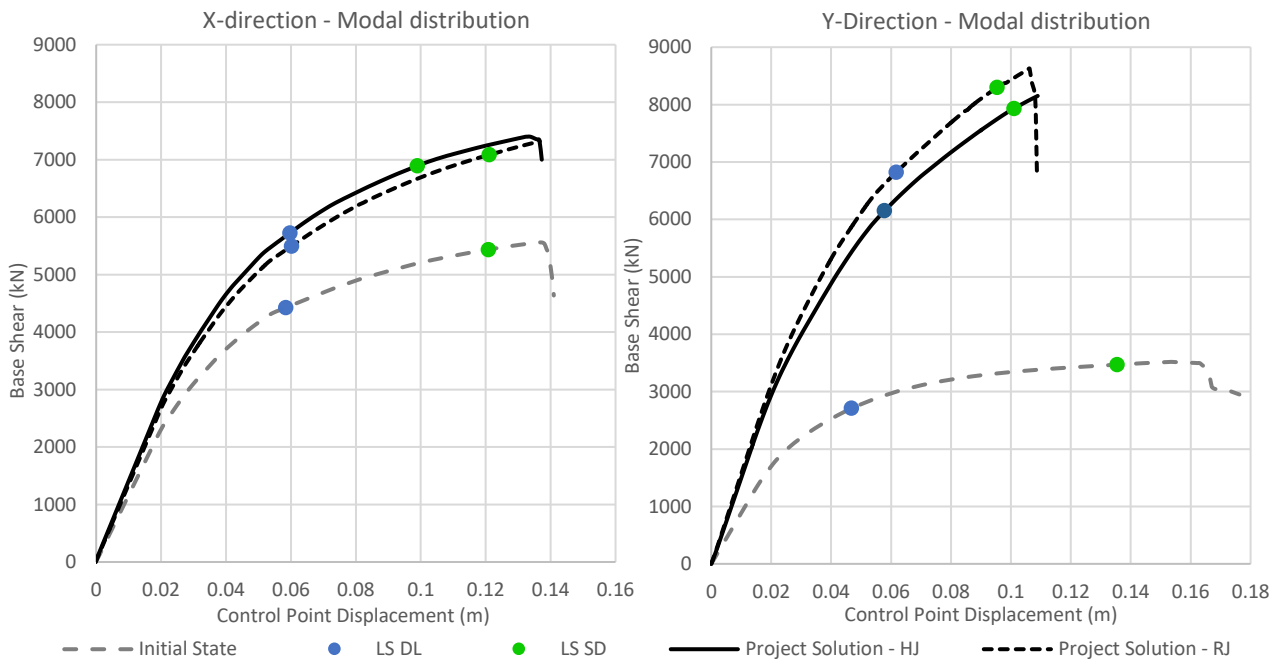

Figure 94 – Capacity curves obtained by pushover analyses with modal distribution of forces, in both main directions, before and after the application of the exoskeleton

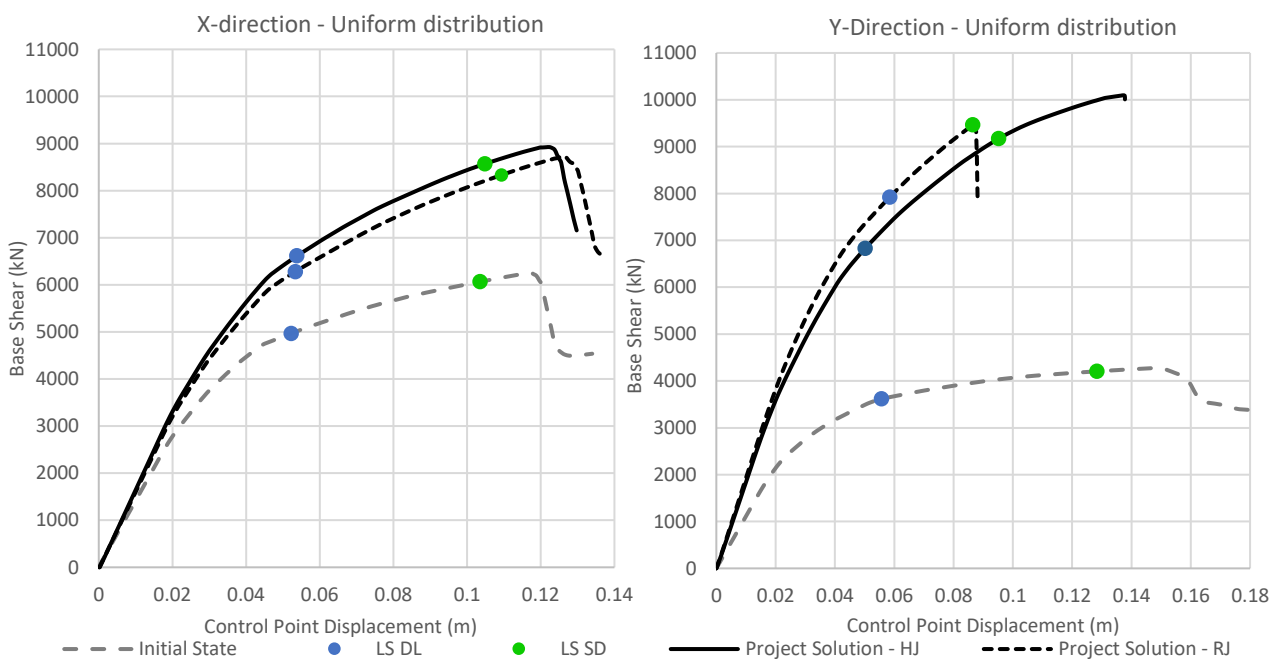

Figure 95 – Capacity curves obtained by pushover analyses with uniform distribution of forces, in both main directions, before and after the application of the exoskeleton

In many cases the critical displacements depend on the different distributions of stresses in plastic hinges and variations of the stiffness of the steel structural members could govern the collapse at different points for different displacements. Often in these cases brittle failures of RC columns at the base level do not allow a complete exploitation of the exoskeleton, limiting the improvement to strength and stiffness. By increasing the stiffness of the exoskeleton in the lower levels of the extension, a further reduction of displacements at

the base level might be achieved, distributing the damages over the entire height of the building, retarding the premature collapse of the base columns, and increasing the displacement capacity.

Total weight and costs

As mentioned before regarding the type of connection, the results of the seismic analyses performed show minimum advantages on the use of hinge connections (exploitation of the exoskeleton against the horizontal loads and results from linear dynamic analyses). Therefore, the choice between the two options could strongly depend on the manufacturing processes, installation procedures, and the costs; without considering a mandatory local analysis of the state of the RC elements in proximity of the joint, in relation with the final actions transferred by the connection. An overview of the proposed solution is described in Section 5.1.5.

Finally, to evaluate performances in relation to costs, a brief report of the material quantities and the relative costs is presented. For all the solutions, the connection between the exoskeleton and the existing structure is provided with the hinge connection (HL) fixed to an UPN-profile all along the perimeter of all the floors (Section 5.1.5). After an evaluation of the amount of profiles used (Table 59), taking as reference an Italian price table [147], it was possible to obtain a basic cost of the steel used (Table 60). Finally, considering the treatments of the steel (Table 61), a total cost for the whole exoskeleton, but excluding foundation, was calculated (Table 62).

Table 58 – Weight and costs of the hinge connections

Hinged joint	N°	kg	€/kg	€
Hinge – Estimated 80 kg per unit	150	12'000	8.42	101'040
Perimetral UPN240 (33.2 kg/m)	5x60m	9'960	3.08	30'677
Treatments (galvanization)		21'960	0.66	14'494
			TOTAL	146'211

Table 59 – Summary of the quantities of the steel exoskeleton

Section Text	Object Type	Steel grade	Total Length (m)	Total Weight (kN)
HE280A	Column	S275	500.16	374.593
HE140B	Long. Beam	S275	507.5	167.974
HE160A	Trans. Beam	S275	292.192	87.264
PIPE-D76.1X3.2	Bracing	S235	439.36	24.786
PIPE-D114.3X7	Bracing	S235	140.83	13.572
HE100A	Trans. Beam (stairs)	S275	9.00	1.469
				669.658 kN = 68'286.11 kg

Table 60 – Cost of the steel used

Calculation of the cost for the steel material		
	Total Weight (kg)	Cost (€)
Total simple profiles (2.90€/kg)	64'374.663	186'686.52
Total pipe profiles (4.14€/kg)	3'911.447	16'193.40
Material total		202'880

Table 61 – Cost of the steel treatments

Calculation of the cost for the steel treatments		
	Total Weight (kg)	Cost – Galvanization (€)
Total profiles (0.66€/kg)	68'286.11	45'069

Table 62 – Total cost of the steel solution

TOTAL

	Costs (€)
Total carpentry	202'880
Total steel treatments	45'069
Connection	146'211
TOTAL	394'160

5.1.3 Project state, impact assessment of on-top extension

In order to respond to the architectural needs of extensions, that could further mitigate the economic impact of the intervention, two additional structural configurations are planned with a connection above the roof. The aim of this section is to evaluate the possible structural benefits of a structural connection between steel shear walls placed on opposite sides. Two variants are therefore analysed: one involving a Vierendeel beam capable of supporting an additional floor within the height of the beam and the photovoltaic system on top; while the other involves a steel truss beam designed to support photovoltaic panels. The roof extensions are proposed in continuity with the perimeter solution, with hinged connections (HL), shown in the previous section. In this section, only information not previously specified and concerning the roof extensions is reported.

5.1.3.1 Structural scheme and characterisation of the members

The steel shear walls were extended vertically above the roof of the RC structure and connected by a 3 m high Vierendeel beam (Figure 96a) and by a truss beam (Mohniè type) with steps of approximately 1×0.7 m (Figure 96b). The elevation schemes of the two solutions in Figure 97 represent the main dimensions of the structures. The lower beams of the Vierendeel are 1 m above the roof slabs of the existing building and designed to support a walkable floor. The upper beams are designed to support a photovoltaic system and snow loads. The trusses are placed 3 m above the existing roof with profiles designed to support the same loads of the other solution.

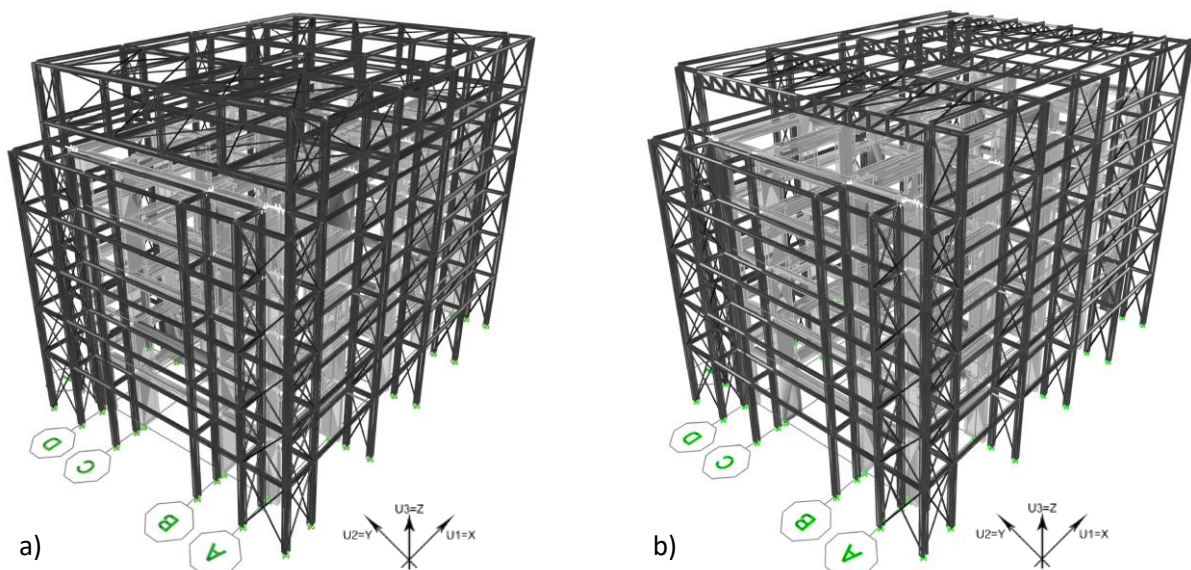

Figure 96 – Panoramic view of the finite element model of the application of the exoskeleton with roof-extensions on the north part of the Athens case study; a) Vierendeel beam; b) truss beam

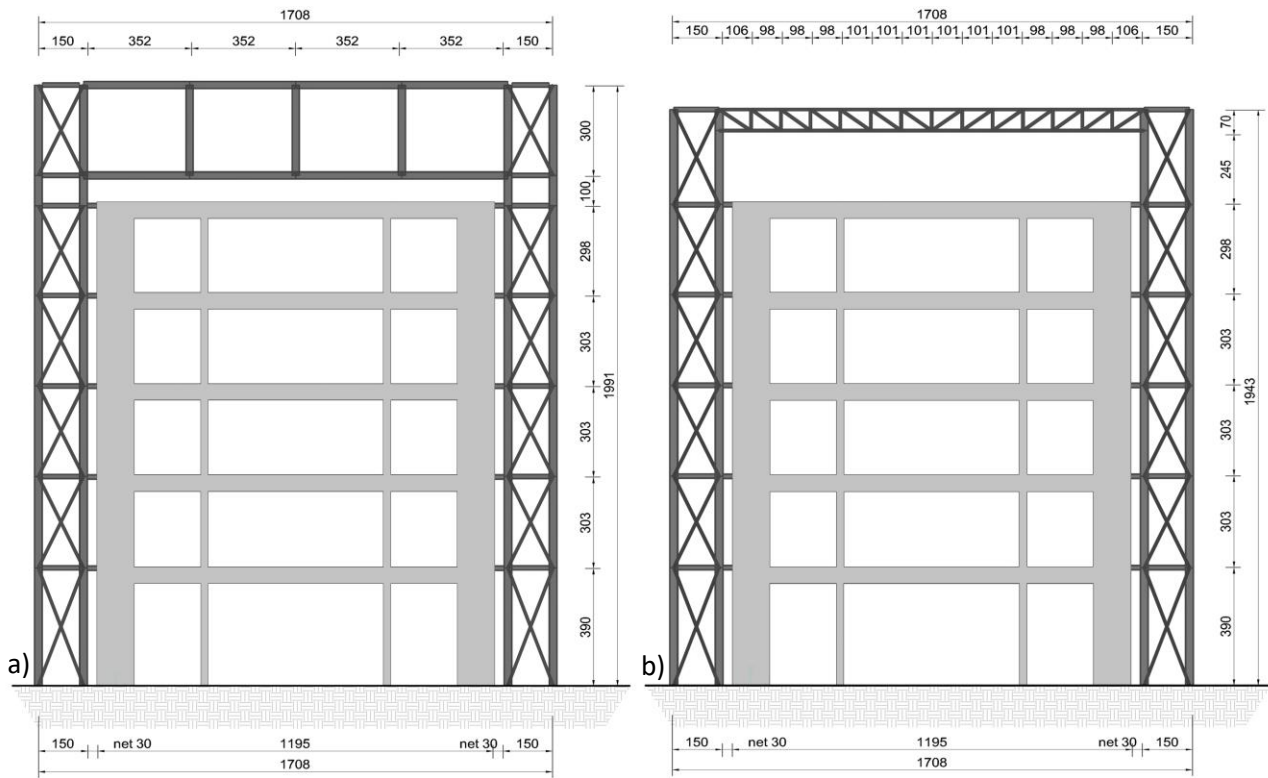

Figure 97 – Elevation schemes of the roof-extension solutions of the exoskeleton (cm as units); a) Vierendeel beam; b) truss beam

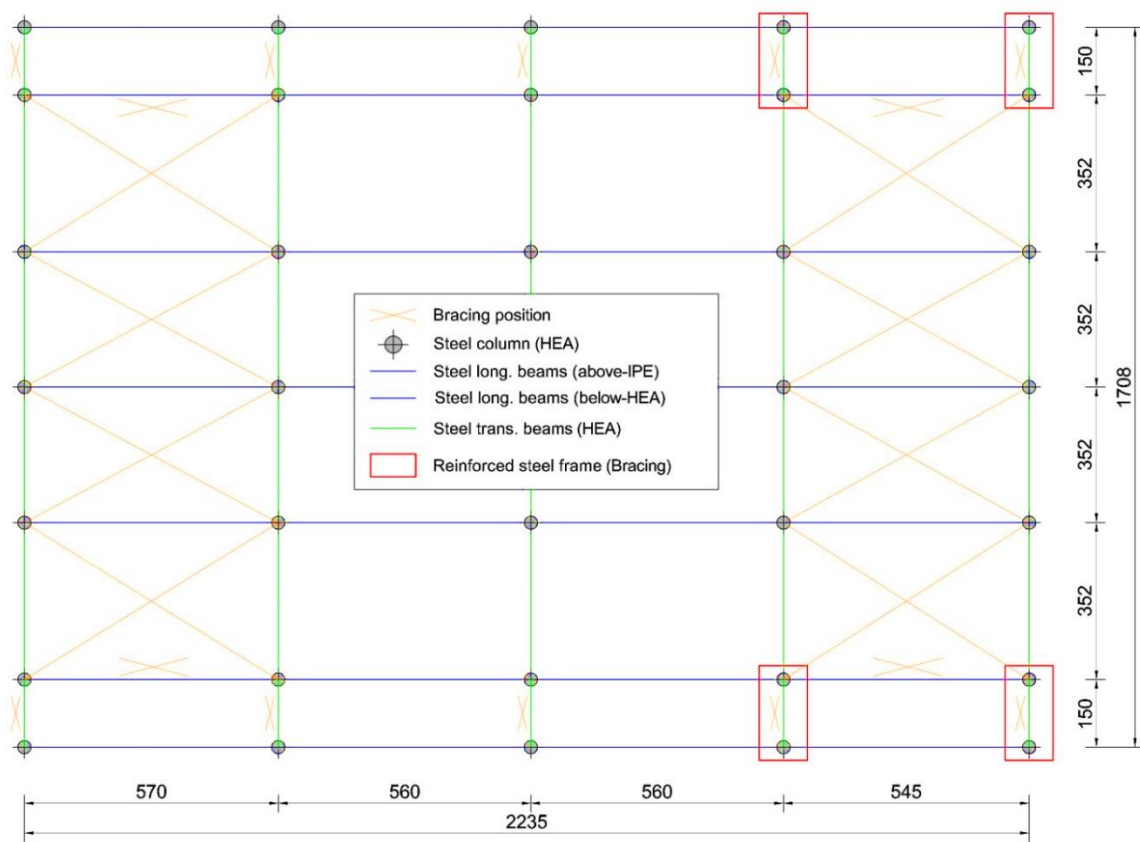

Figure 98 – Planimetric scheme of the roof-extension, with Vierendeel beams, identifying the profiles used and indicating the positions of the bracing (cm as units)

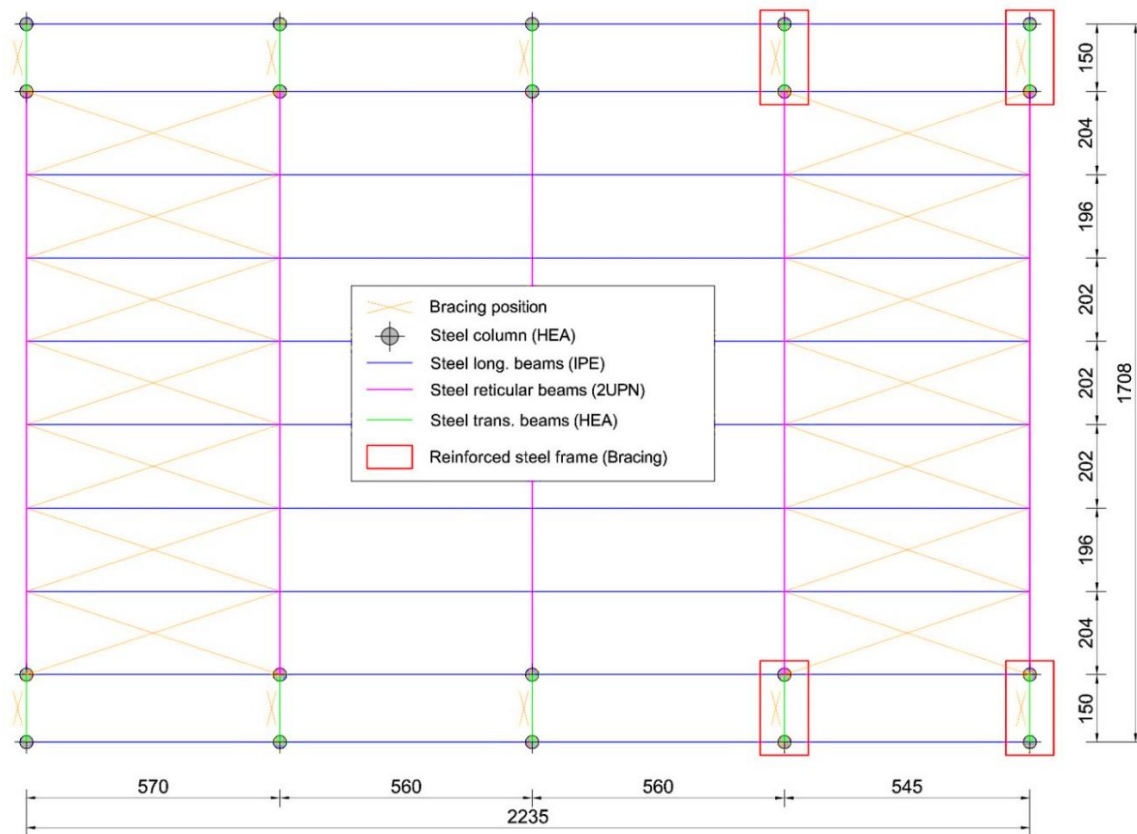

Figure 99 – Planimetric scheme of the roof-extension, with truss beams, identifying the profiles used and indicating the positions of the bracing (cm as units)

The steel profiles used for the roof extensions and verified under the design loads are listed in Table 63, while those for the perimeter frames remain unchanged. Figures 98 and 99 show the structural schemes of the Vierendeel and truss beams integrated in the perimeter extension.

Table 63 – Profiles used for the top-addition solutions

Project solution with Vierendeel beam			Project solution with truss beam		
Structural element	Cross-Section	Steel Grade	Structural element	Cross-Section	Steel Grade
Columns - Frame	HEA280	S275	Columns - Frame	HEA280	S275
Columns Vierendeel	HEA260	S275	Upper chord	2UPN 80/10	S275
Trans. internal Beams	HEA280	S275	Lower chord	2UPN 80/10	S275
Trans. Beams - Frame	HEA160	S275	Diagonal	2UPN 80/10	S275
Long. Beams (above)	IPE180	S275	Vertical	2UPN 80/10	S275
Long. Beams (below)	HEA220	S275	Purlins	IPE 160	S275
Bracing pipes	φ76.1x3.2	S235	Bracing pipes	φ76.1x3.2	S235
Bracing pipes in RSF	φ114.3x7	S235	Bracing pipes in RSF	φ114.3x7	S235

5.1.3.2 Modelling parameters

Load patterns

Table 64 shows the loads applied to the two roof-extension solutions in addition to the self-weight of the structural elements already calculated by the software. Reference is made to the previous section for the load patterns concerning the perimeter exoskeleton and the existing building.

Table 64 – Load patterns assigned to the floors of the extensions

Vierendeel solution			
	Self-weight	Dead load	Live load
Roof	1 kN/m ²	1 kN/m ²	Snow = 0.34 kN/m ² ; H = 2 kN/m ²
Roof floor	–	pv system = 0.5 kN/m ²	Snow = 0.34 kN/m ²
Truss solution			
Roof floor	–	pv system = 0.5 kN/m ²	Snow = 0.34 kN/m ²

Response spectrum functions and q-factors

The horizontal elastic response spectra are the same as those considered in the previous paragraph. The design response spectrum considered in the linear dynamic analysis depends on the behaviour factors (q). The new distribution of masses and stiffnesses made it possible to eliminate the 20% reduction of the q-factor [12] and brought the value K_r of equation (5.2) to 1.0. Together with the increase of the overstrength ratios higher q-factor values were deduced from the capacity curves obtained from the non-linear static analysis. Table 65 shows the minimum values calculated and used in the analyses.

Table 65 – q-factor values for the project state with Vierendeel and truss beams

LS Significant Damage	q – Initial state	q – Vierendeel	q – Truss
Pushover analysis in longitudinal direction (X)	3.01	3.50	3.87
Pushover analysis in transverse direction (Y)	2.84	4.31	4.20
Verification for brittle failures	1.50	1.50	1.50

The two solutions with roof-extensions have similar q-factor values compared to the HL project solution (Table 45), presenting higher values for the transverse direction than for the longitudinal direction.

5.1.3.3 Results

Modal analysis

The following are the results of the first four vibration modes after application of the steel exoskeleton (Table 66 and 67). As shown by the participating masses and in Figure 100, the application of the exoskeleton allows to adjust the dynamic behaviour avoiding torsional components in the first two vibration modes. The provision of the two RSFs on the south side allowed to adjust the dynamic behaviour of the structure.

Table 66 – Results of the modal analysis of the project solution with Vierendeel beams

Project Solution (HJ) with Vierendeel beams				
Mode	Period (s)	Participation Mass		
		U1	U2	RZ
1	0.667	84.81%	≈ 0	≈ 0
2	0.605	≈ 0	84.06%	0.28%
3	0.583	≈ 0	0.32%	84.56%
4	0.307	≈ 0	≈ 0	≈ 0

Table 67 – Results of the modal analysis of the project solution with truss beams

Project Solution (HJ) with truss beams				
Mode	Period (s)	Participation Mass		
		U1	U2	RZ
1	0.649	85.27%	≈ 0	≈ 0
2	0.587	≈ 0	84.10%	0.69%
3	0.565	≈ 0	0.78%	83.73%
4	0.268	1.62%	≈ 0	≈ 0

The application of roof-extensions does not imply substantial changes in the dynamic behaviour of the strengthened structure, even though they increase the height of the building. Only in the case with Vierendeel beams the periods are slightly increased due to a more relevant increase of the masses (compared to the truss solution).

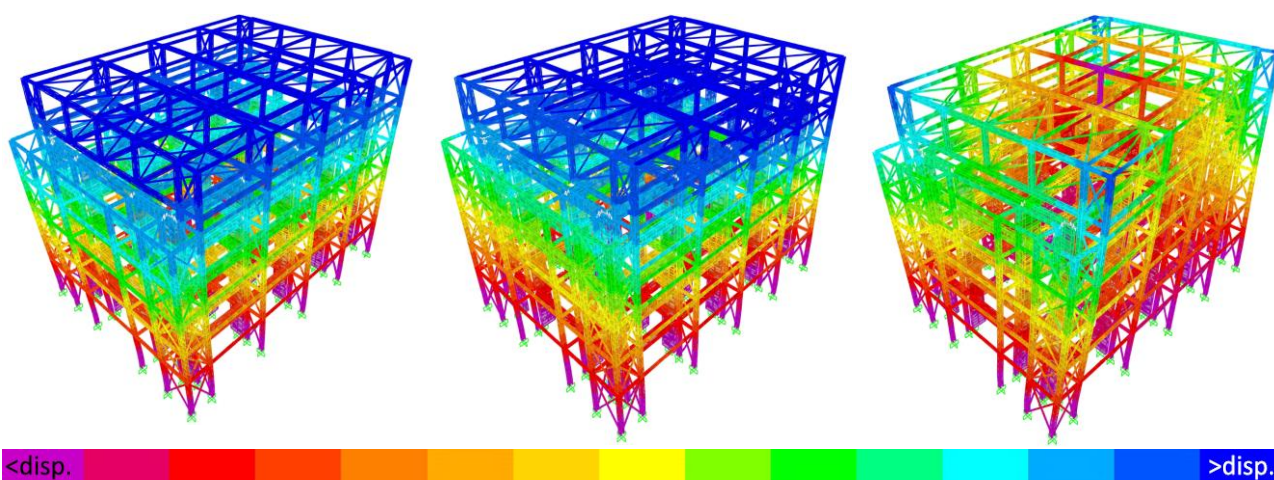

Figure 100 - Representation of the first three main vibration modes in ascending order from left to right for the project solution (HL) with Vierendeel upper connection; the displacements increase from purple to blue

Linear dynamic analysis

The values of the maximum displacements of the same nodes of the previous section are shown in Table 68. In addition, the relative percentages of variations at the LS DL are reported.

Table 68 - Maximum displacements calculated with the linear dynamic analysis for both main directions (X and Y) for the project solutions with hinged (HL) and rigid connections (RL)

Athens case study	Project solution (HL) with Vierendeel beams		Project solution (HL) with truss beams	
LS DL	U1 (mm)	U2 (mm)	U1 (mm)	U2 (mm)
δ_{max} (Existing roof)	53.0	51.1	53.0	50.5
-Δ-	17.1%	32.9%	17.1%	33.7%

The results are aligned to the solution without roof-extension.

The vulnerability analysis was then carried out in terms of maximum stresses in the structural elements and interstorey displacements as described in Section 5.1.1.4. The vulnerability assessment carried out with dynamic linear analysis (force-based design) for LS SD was found to be satisfied with higher percentages of the design seismic loads (Table 69).

Table 69 – Seismic vulnerability assessment with linear dynamic analysis

Vulnerability assessment with linear dynamic analysis – LS SD	
Project solution with Vierendeel beams	Project solution with Truss beams
$85\% \leq E(a_g)_{LS SD} \leq 90\%$	$85\% \leq E(a_g)_{LS SD} \leq 90\%$

The improvement, as for the project solution without roof extensions, is quantified at about 45% of the design seismic action and related to the reduction of the torsional components, a new distribution of internal stresses, and a reduction of seismic loads due to the increase of behaviour factors.

Regarding the verifications of the interstorey drift, a graph representing the drifts of the more flexible RC moment resisting frame is shown below in Figure 101, indicating the correspondence of the interstorey drifts with and without the roof extensions. The related vulnerability assessment to the LS DL is then reported in Table 70.

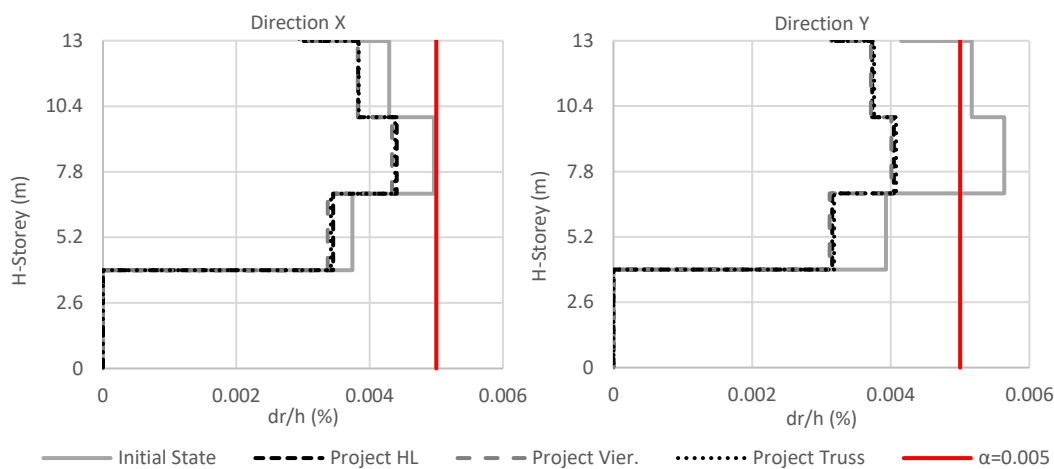

Figure 101 – Interstorey drift verification for the project states (HL and RL) of the Athens case study for both main directions at the LS DL; the values are compared to the requirement for buildings having non-structural elements of brittle materials

Table 70 – Seismic vulnerability assessment with linear dynamic analysis

Vulnerability assessment with linear dynamic analysis – LS DL		
Project solution – HL	Project solution with Vierendeel beams	Project solution with Truss beams
$E(a_g)_{LS DL} = 113\%$	$E(a_g)_{LS DL} = 115\%$	$E(a_g)_{LS DL} = 114\%$

The interstorey drift verification resulted satisfied in both design solutions, without relevant differences, passing from a vulnerability value of 89% to 111%, confirming the simplified results of Table 50.

Verifications of the exoskeleton

The verifications on the structural members of the exoskeleton were carried out by means of the design software. The strength and deformability checks were carried out considering the ultimate limit states (LS SD and ULS) and the operational limits (LS DL and SLS) respectively. The software complies with the European technical standards required for the verification of the steel members, Eurocode 3 and 8 [12, 131]. For a complete overview of the procedures provided by the software, reference is made to the software design manuals (SAP2000 [129]).

Non-linear static analysis (pushover)

The results of the modal analysis show a regular behaviour of the structure with the first two vibration modes not presenting torsional components with percentages of participating masses around 84% for both directions and project solutions. Once all analyses have been carried out for both design solutions (with Vierendeel and truss beams), the reference parameters described in Section 5.1.1.4 have been derived.

Project state, Athens case study (uniform force distribution – X)

Figure 102 – Representation of the capacity curves for both MDOF and SDOF systems and relative bilinearisation of the SDOF curve with the use of the parameters reported on the right; uniform force distribution along X-direction for the HL project solution with Vierendeel roof-extension

Table 71 – Pushover analysis results; uniform force distribution along X-direction

Assessment results – LS Damage Limitation	Vierendeel	Truss
Displacement demand (D)	54.48 mm	59.11 mm
Displacement capacity (C)	59.71 mm	61.89 mm
D/C Ratio	91.2%	95.5%
K_{60}	125'747 kN/m	123'155 kN/m
Total shear capacity - V_{max}	6'520 kN	6'577 kN
$S_e(T)$	0.336 g	0.349 g
$a_{g,c}$	0.337 g	0.346 g
C/D Ratio	100%	99%
Assessment results – LS Significant Damage	Vierendeel	Truss
Displacement demand (D)	69.18 mm	75.06 mm
Displacement capacity (C)	114.73 mm	116.55 mm
D/C Ratio	60.3%	64.4%
K_{60}	125'747 kN/m	123'155 kN/m
Total shear capacity - V_{max}	8'505 kN	8'523 kN
$S_e(T)$	0.430 g	0.443 g
$a_{g,c}$	0.440 g	0.449 g
C/D Ratio	100%	100%
Assessment results – LS Near Collapse	Vierendeel	Truss
Displacement demand (D)	121.42 mm	131.75 mm
Displacement capacity (C)	129.93 mm	132.03 mm
D/C Ratio	93.4%	99.8%
K_{60}	125'747 kN/m	123'155 kN/m
Total shear capacity - V_{max}	8'817 kN	8'850 kN
$S_e(T)$	0.754 g	0.778 g

$a_{g,c}$	0.455 g	0.466 g
C/D Ratio	60%	60%

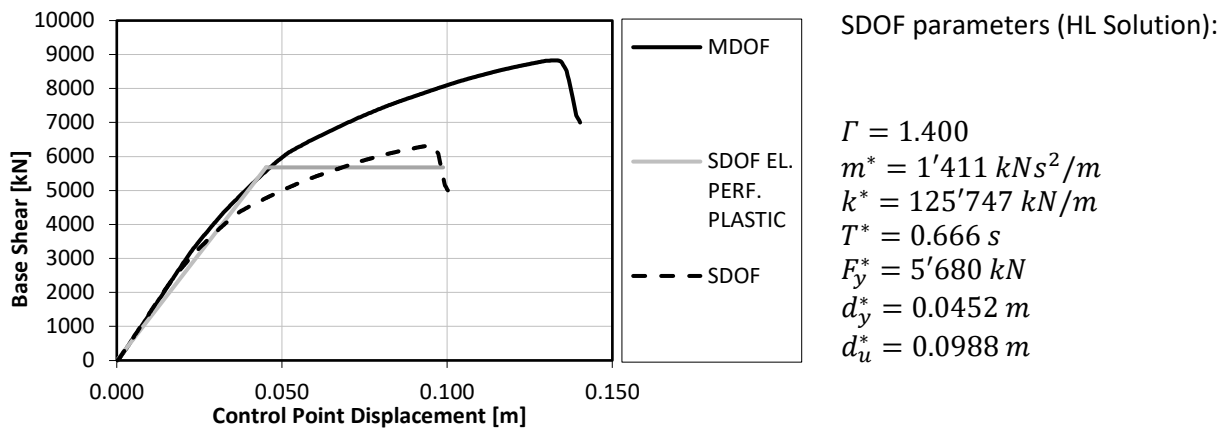
Project state, Athens case study (modal force distribution – X)

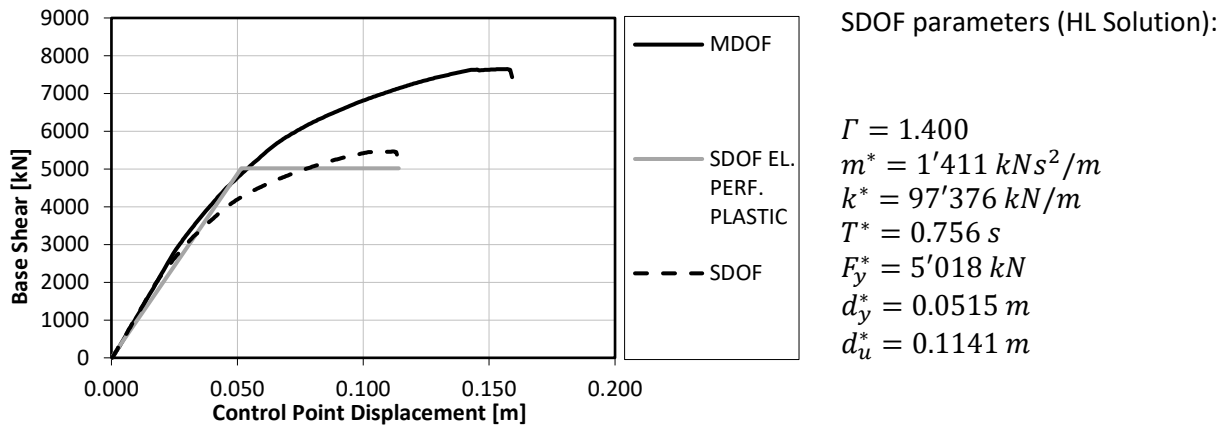

Figure 103 – Representation of the capacity curves for both MDOF and SDOF systems and relative bilinearisation of the SDOF curve with the use of the parameters reported on the right; modal force distribution along X-direction for the HL project solution with Vierendeel roof-extension

Table 72 – Pushover analysis results; modal force distribution along X-direction

Assessment results – LS Damage Limitation	Vierendeel	Truss
Displacement demand (D)	59.81 mm	66.49 mm
Displacement capacity (C)	68.20 mm	72.93 mm
D/C Ratio	87.7%	91.2%
K_{60}	97'376 kN/m	94'181 kN/m
Total shear capacity - V_{max}	5'791 kN	5'686 kN
$S_e(T)$	0.336 g	0.349 g
$a_{g,c}$	0.300 g	0.299 g
C/D Ratio	89%	86%
Assessment results – LS Significant Damage	Vierendeel	Truss
Displacement demand (D)	75.94 mm	84.44 mm
Displacement capacity (C)	127.8 mm	115.01 mm
D/C Ratio	59.4%	73.4%
K_{60}	97'376 kN/m	94'181 kN/m
Total shear capacity - V_{max}	7'401 kN	6'814 kN
$S_e(T)$	0.430 g	0.443 g
$a_{g,c}$	0.382 g	0.359 g
C/D Ratio	89%	81%
Assessment results – LS Near Collapse	Vierendeel	Truss
Displacement demand (D)	133.30 mm	148.20 mm
Displacement capacity (C)	142.8 mm	115.01 mm
D/C Ratio	93.3%	128.9%
K_{60}	97'376 kN/m	94'181 kN/m
Total shear capacity - V_{max}	7'624 kN	6'814 kN
$S_e(T)$	0.754 g	0.778 g
$a_{g,c}$	0.393 g	0.359 g
C/D Ratio	52%	46%

Project state, Athens case study (uniform force distribution – Y)

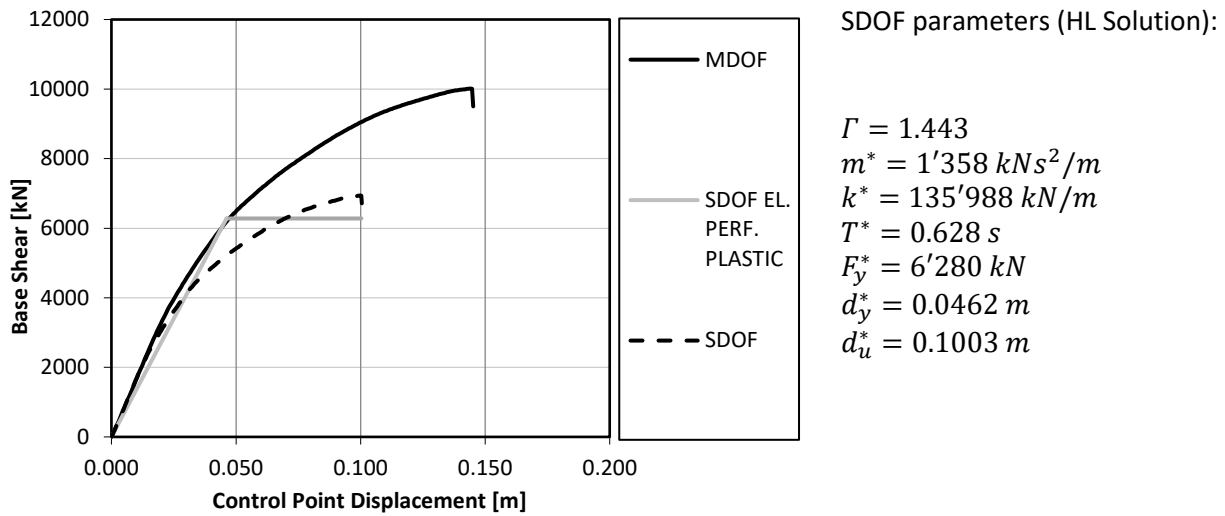

Figure 104 – Representation of the capacity curves for both MDOF and SDOF systems and relative bilinearisation of the SDOF curve with the use of the parameters reported on the right; uniform force distribution along Y-direction for the HL project solution with Vierendeel roof-extension

Table 73 – Pushover analysis results; uniform force distribution along Y-direction

Assessment results – LS Damage Limitation	Vierendeel	Truss
Displacement demand (D)	53.17 mm	51.00 mm
Displacement capacity (C)	55.03 mm	53.06 mm
D/C Ratio	96.6%	96.1%
K_{60}	135'988 kN/m	141'888 kN/m
Total shear capacity - V_{max}	6'824 kN	6'812 kN
$S_e(T)$	0.378 g	0.384 g
$a_{g,c}$	0.385 g	0.363 g
C/D Ratio	100%	95%
Assessment results – LS Significant Damage	Vierendeel	Truss
Displacement demand (D)	67.51 mm	64.76 mm
Displacement capacity (C)	102.01 mm	100.77 mm
D/C Ratio	66.2%	64.3%
K_{60}	135'988 kN/m	141'888 kN/m
Total shear capacity - V_{max}	9'114 kN	9'094 kN
$S_e(T)$	0.480 g	0.488 g
$a_{g,c}$	0.514 g	0.485 g
C/D Ratio	100%	99%
Assessment results – LS Near Collapse	Vierendeel	Truss
Displacement demand (D)	118.50 mm	113.67 mm
Displacement capacity (C)	102.01 mm	100.77 mm
D/C Ratio	116.2%	112.8%
K_{60}	135'988 kN/m	141'888 kN/m
Total shear capacity - V_{max}	9'114 kN	9'094 kN
$S_e(T)$	0.843 g	0.857 g
$a_{g,c}$	0.514 g	0.485 g
C/D Ratio	61%	57%

Project state, Athens case study (modal force distribution – Y)

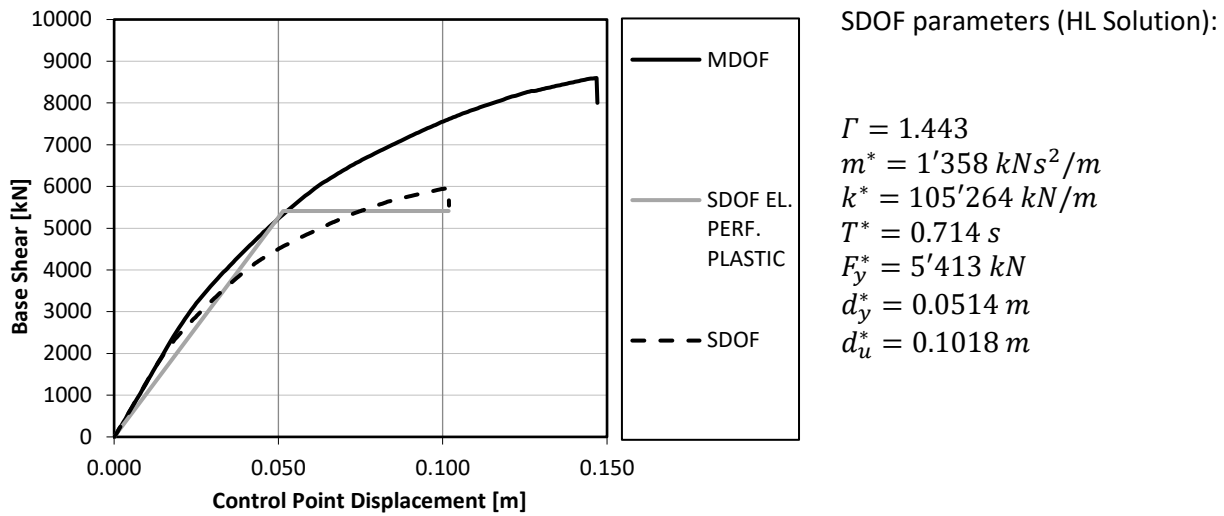

Figure 105 – Representation of the capacity curves for both MDOF and SDOF systems and relative bilinearisation of the SDOF curve with the use of the parameters reported on the right; modal force distribution along Y-direction for the HL project solution with Vierendeel roof-extension

Table 74 – Pushover analysis results; modal force distribution along Y-direction

Assessment results – LS Damage Limitation	Vierendeel	Truss
Displacement demand (D)	59.22 mm	56.87 mm
Displacement capacity (C)	61.78 mm	59.49 mm
D/C Ratio	95.9%	95.6%
K_{60}	105'264 kN/m	111'812 kN/m
Total shear capacity - V_{max}	5'992 kN	6'011 kN
$S_e(T)$	0.378 g	0.384 g
$a_{g,c}$	0.312 g	0.321 g
C/D Ratio	83%	83%
Assessment results – LS Significant Damage	Vierendeel	Truss
Displacement demand (D)	75.20 mm	72.22 mm
Displacement capacity (C)	106.14 mm	98.27 mm
D/C Ratio	70.9%	73.5%
K_{60}	105'264 kN/m	111'812 kN/m
Total shear capacity - V_{max}	7'748 kN	7'538 kN
$S_e(T)$	0.480 g	0.488 g
$a_{g,c}$	0.403 g	0.402 g
C/D Ratio	84%	82%
Assessment results – LS Near Collapse	Vierendeel	Truss
Displacement demand (D)	132.00 mm	126.76 mm
Displacement capacity (C)	106.14 mm	98.27 mm
D/C Ratio	124.4%	129.0%
K_{60}	105'264 kN/m	111'812 kN/m
Total shear capacity - V_{max}	7'748 kN	7'538 kN
$S_e(T)$	0.843 g	0.857 g
$a_{g,c}$	0.403 g	0.402 g
C/D Ratio	48%	47%

5.1.3.4 Result comparison and final quantities

A comparison of the parameters introduced in Section 5.1.2.4 is reported, concerning the results of the non-linear static analysis. It can be noted that with respect to the project solution without roof extension, non-remarkable differences are reported, as shown from the results of the linear dynamic analysis. Furthermore, a preliminary impact in terms of weight and costs of the structure is presented.

Non-linear static analysis – results comparison

In order to evaluate the strengthening intervention by means of external steel shear walls applied perpendicularly to the existing façades, the set of parameters introduced in Section 5.1.2.4 was compared before and after the application of the exoskeleton.

- Regarding TDVs, no substantial differences in the results were found and reference is made to the previous section. Substantial improvement in terms of LS DL but worsening with respect of inelastic displacements of the structure, with a worsening at the LS NC. Further analyses have been carried out in this regard in the following section.
- Considering the results of the worst case (modal) configuration, the stiffness of the structure, with respect to the initial state, does not present an increase from the initial value of 98'990 kN/m in longitudinal direction; probably due to the increased height of the building that along that direction is not compensated by additional stiffening structures (the roof extensions are connecting only the steel shear walls applied on the east and west side). Along the transverse direction the resultant stiffness is comparable or lower than that of the solution without roof extension (105'264 kN/m for the solution with Vierendeel and 111'812 kN/m for the other one).
- The C/D ratios in terms of simplified maximum collapse acceleration ($a_{g,c}$) record the increase in strength directly linked to the entity of the lateral forces, taking into account the increase in demand due to the reduction of the natural periods on the elastic response spectra. No substantial differences in the results were found and reference is made to the previous section.

Exploitation of the exoskeleton

With the aim of assessing the exploitation of the exoskeleton, the part of horizontal force taken by the exoskeleton is extrapolated and compared with the total action. The values are derived from pushover analyses with modal force distribution (as the worst case) and in relation to the limit states defined by the standards (Tables 75 and 76).

Table 75 – Exploitation of the exoskeleton in terms of horizontal forces; calculated at the steps of the pushover analysis corresponding to the interested LS with modal force distribution for the HL project solution with Vierendeel beams

Athens case study – Project solution HL with Vierendeel beams				
PUSH-X Mode	Total Shear (kN)	Existing Structure (kN)	Steel Exoskeleton (kN)	Exploitation (%)
LS DL	5'791	4'734	1'057	18.3%
LS SD	7'401	5'491	1'910	25.8%
LS NC	7'624	5'568	2'056	27.0%
PUSH-Y Mode	Total Shear (kN)	Existing Structure (kN)	Steel Exoskeleton (kN)	Exploitation (%)
LS DL	5'992	3'865	2'127	35.5%
LS SD	7'748	4'038	3'710	47.9%
LS NC	Coincides with the LS SD			

Table 76 – Exploitation of the exoskeleton in terms of horizontal forces; calculated at the steps of the pushover analysis corresponding to the interested LS with modal force distribution for the HL project solution with truss beams

Athens case study – Project solution HL with truss beams				
PUSH-X Mode	Total Shear (kN)	Existing Structure (kN)	Steel Exoskeleton (kN)	Exploitation (%)
LS DL	5'686	4'548	1'138	20.0%
LS SD	6'814	5'019	1'795	26.3%
LS NC	Coincides with the LS SD			
PUSH-Y Mode	Total Shear (kN)	Existing Structure (kN)	Steel Exoskeleton (kN)	Exploitation (%)
LS DL	6'011	3'843	2'168	36.07%
LS SD	7'538	4'040	3'498	46.40%
LS NC	Coincides with the LS SD			

As can be seen from these results, the exploitation of the exoskeleton is around 30% in longitudinal direction and around 40-50% in the transverse direction. These values are aligned to the values from the previous section, confirming no substantial improvement.

Capacity curves comparison

The capacity curves obtained through non-linear static analyses are shown below, for both the main directions. The coordinates corresponding to the exceeding of the limit states of DL and SD are also indicated for each curve. The curves in Figures 106 and 107 compare the two solutions with roof-extensions with the previous project solution (HL) and the initial state. From the graphs it is visible that the behaviour of the strengthened solutions is very similar.

Therefore, as can be seen from the values in the tables above (Table 71-74), the comparisons made above, the exploitation results and the subsequent capacity curves (Figures 106 and 107), the connection of the steel shear walls at the roof level does not lead to an improvement in seismic performance and must be pursued principally for architectural reasons.

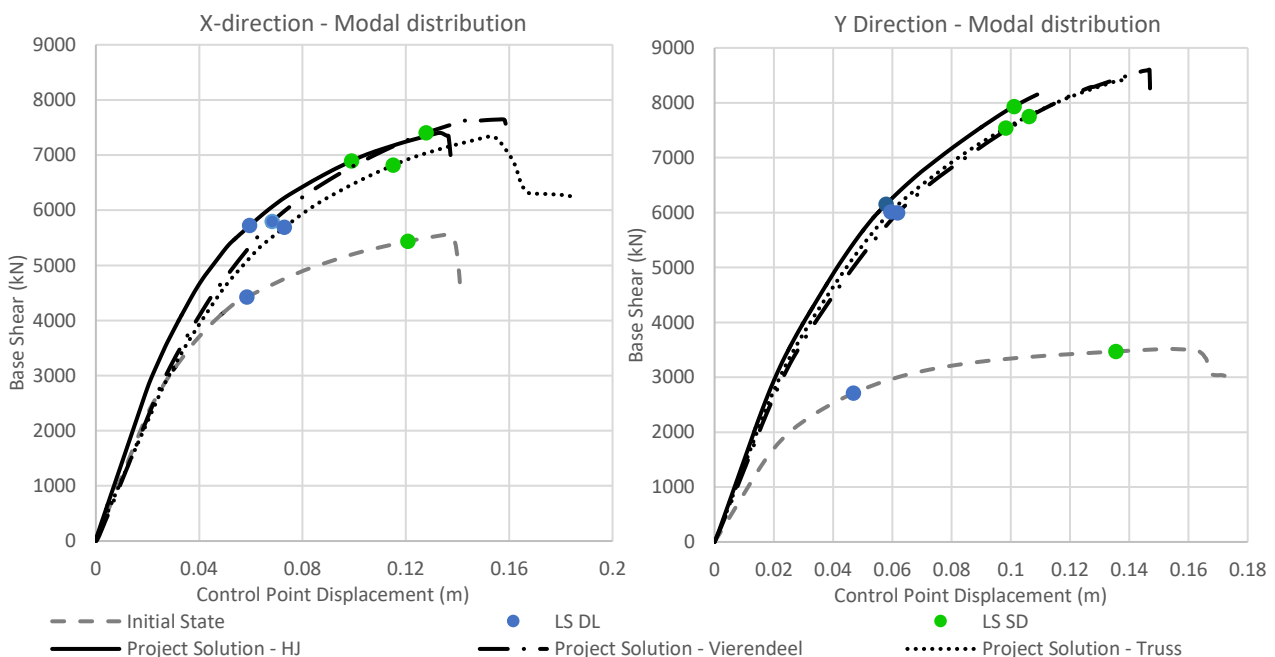

Figure 106 – Capacity curves obtained by pushover analyses with modal distribution of forces, in both main directions, before and after the application of the different exoskeletons with hinged connection (with and without roof-extensions)

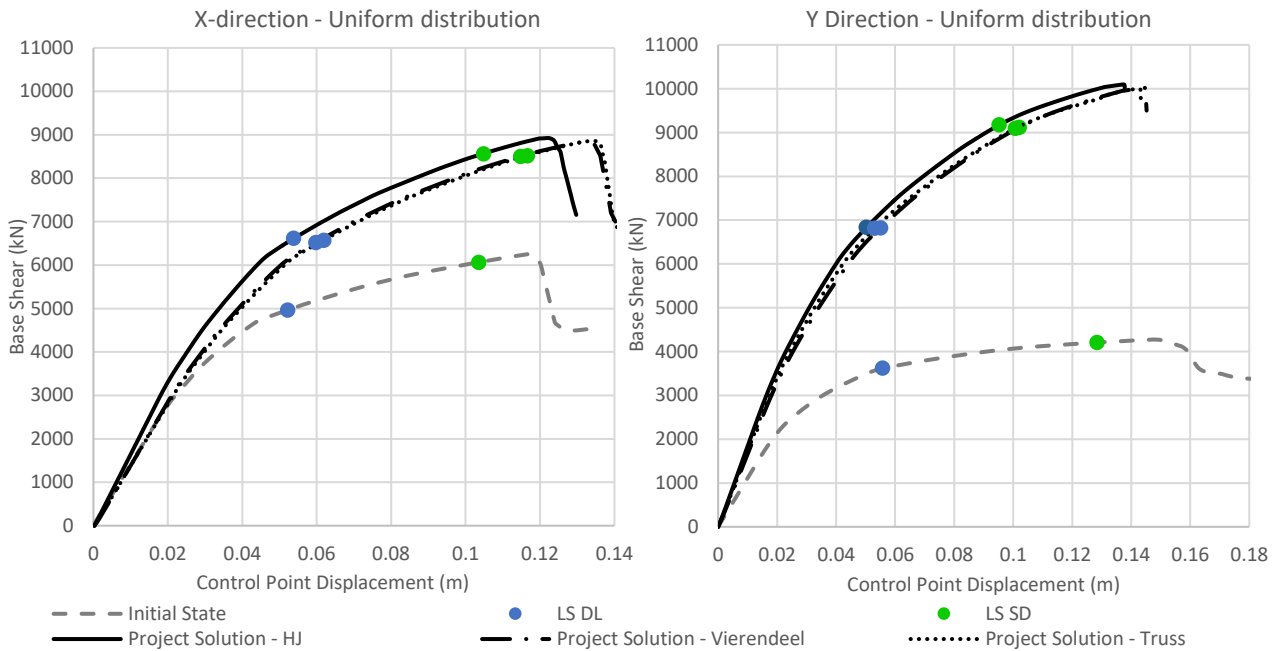

Figure 107 – Capacity curves obtained by pushover analyses with uniform distribution of forces, in both main directions, before and after the application of the different exoskeletons with hinged connection (with and without roof-extensions)

Total weight and costs

A brief report of the materials quantities and the relative costs is presented. After an evaluation of the amount of profiles used (Tables 77 and 81), taking as reference an Italian price table [147], it was possible to obtain a basic cost of the steel used (Tables 78 and 82). Finally, considering the treatments of the steel (Tables 79 and 83) a total cost for the whole exoskeleton, but excluding foundation, was calculated (Tables 80 and 84).

Project solution (HJ) with Vierendeel beam for roof-extensions

Table 77 – Summary of the quantities of the steel exoskeleton with Vierendeel beam

Section Text	Object Type	Steel Grade	Total Length (m)	Total Weight (kN)
HE160A	Trans. Beam	S275	313.192	93.536
HE220A	Long. Beam (Vierendeel)	S275	156.45	77.433
HE260A	Column (Vierendeel)	S275	143.49	95.869
HE280A	Column	S275	631.37	472.862
IPE180	Long. Beam (Vierendeel)	S275	156.45	28.781
HE140B	Long. Beam	S275	507.5	167.974
PIPE-D76.1X3.2	Bracing	S235	741.21	41.814
PIPE-D114.3X7	Bracing	S235	167.66	16.158
HE100A	Trans. Beam (stairs)	S275	9.00	1.469
-	-	-	-	995.896 kN = 101'553.13 kg

Table 78 – Cost of the steel used

Calculation of the cost for the steel material		
	Total Weight (kg)	Cost (€)
Total simple profiles (2.90€/kg)	95'641.6	277'360.64
Total pipe profiles (4.14€/kg)	5'911.530	24'473.73
Material total		301'834

Table 79 – Cost of the steel treatments

Calculation of the cost for the steel treatments		
	Total Weight (kg)	Cost – Galvanization (€)
Total profiles (0.66€/kg)	101'553.13	67'025.07

Table 80 – Total cost of the steel solution

TOTAL	
	Costs (€)
Total carpentry	301'834
Total steel treatments	67'025.07
Connection	146'211
TOTAL	515'070

Project solution (HJ) with truss beam for roof-extensions

Table 81 – Summary of the quantities of the steel exoskeleton with truss beam

Section Text	Object Type	Steel grade	Total Length (m)	Total Weight (kN)
HE160A	Trans. Beam	S275	307.192	91.794
HE280A	Column	S275	563.16	421.776
HE100A	Trans. Beam (stairs)	S275	9	1.469
HE140B	Long. Beam	S275	507.5	167.974
IPE160	Purlins	S275	223.5	34.579
2UPN80/10/	Reticular elements	S275	271.9387	46.134
PIPE-D76.1X3.2	Bracing	S235	647.1659	36.509
PIPE-D114.3X7	Bracing	S235	168.7426	16.262
-	-	-	-	816.497 kN = 83'259.52 kg

Table 82 – Cost of the steel used

Calculation of the cost for the steel material		
	Total Weight (kg)	Cost (€)
Total simple profiles (2.90€/kg)	77'878.35	225'847.21
Total pipe profiles (4.14€/kg)	5'381.172	22'278.05
Material total		248'125.3

Table 83 – Cost of the steel treatments

Calculation of the cost for the steel treatments		
	Total Weight (kg)	Cost – Galvanization (€)
Total profiles (0.66€/kg)	83'259.52	54'951.3

Table 84 – Total cost of the steel solution

TOTAL	
	Costs (€)
Total carpentry	248'125.3
Total steel treatments	54'951.3
Connection	146'211
TOTAL	449'288

5.1.4 Non-linear dynamic analyses results and considerations

The application of the exoskeleton increases the overall stiffness and capacity. From the analyses carried out on the Athens case study, it can be deduced that the steel exoskeleton allows to withstand more horizontal forces without burdening the existing structure, with an exploitation of the new structures around 50% in transverse direction (both sides extension). With the linear dynamic analyses, an increase of the behaviour factor q linked to a reduced torsional behaviour and an increase of the overstrength factor, and a better stress distribution allow a substantial improvement of the existing building.

As regards non-linear static analyses, the increase in overall resistance occurs at the expense of a reduction of displacements. This reduction translates for TDVs into better performance against frequent earthquakes (LS DL) and worse performance against rare and strong events (LS NC) that usually exploit the energy dissipation affecting the existing structures through higher displacements and additional damages, as reported in other similar studies [52, 113, 118]. Therefore, in order to better understand the behaviour of the structure during a high intensity seismic event, non-linear dynamic analyses (NLDA) were performed.

NLDAs consider the inelastic behaviour of the structure as much as pushover analysis, but it is considered a more accurate analysis since it does not have to subdue to approximations on the horizontal load distributions. Instead of having monotonous forces applied in one direction with an approximate force distribution, it provides accelerograms as acceleration history over time. For this reason, they are also called time-history (TH) analyses. During NLDAs the hysteretic dissipation of the members and any devices is considered to evaluate the viscous damping ratio (ξ) which is used to determine the relative damping correction factor (η); the latter always considering for the determination of the response spectrum used in linear dynamic analysis [12].

5.1.4.1 Modelling parameters

Inelastic behaviour of the members

The evaluation with NLDAs was carried out on the existing structure (initial state) and on the project solution with hinged connections (project state HL). No changes were provided to the FEM with respect to the models prepared for the pushover analysis. The definition of the non-linear hinges in SAP2000 [129] is therefore in accordance with Sections 5.1.1 for the initial state and 5.1.2 for the project state. The plastic force-deformation curve defines the non-linear behaviour during monotonic loading and is defined by an initial elastic part of the hinge dependent on its length. The hysteresis model is defined for cyclic loading and may deviate from the backbone curve depending on the type of modelling assigned to the hinges or materials. For single degree of freedom hinges the hysteresis models automatically assigned by the software are Kinematic for steel-based hinges and Takeda for RC hinges; while for P-M2-M3 coupled hinges only the isotropic model is applicable [145].

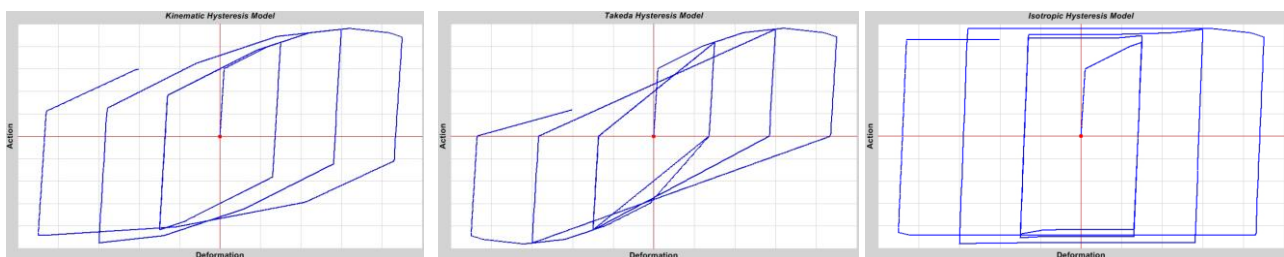

Figure 108 – Hysteresis models under increasing cyclic loads; in order from left to right: Kinematic, Takeda and Isotropic models – Source: [145]

Cracking as a reduction in RC structural elements was retained as introduced in Section 5.1.1 for obtaining the results reported below; however, in order to consider the progressive damage of the elements only through progressive dissipation exploited by the hysteretic behaviour of the hinges, further analyses were performed without reduced stiffnesses, resulting in similar or even more conservative results in terms of displacements and without encountering brittle failures of force-controlled plastic hinges, not conservatively affected by the reduction in stiffness.

Seismic load combinations and accelerograms

As with the pushover analysis, the NLDA starts following the application of vertical loads based on the seismic combination that provides coefficients equal to the QP (GRAV in Section 5.1.1.3).

The seismic action is represented by time histories of ground motion, the selection of which must be compatible with a reference elastic spectrum, based on the investigated performance level (LS DL, SD, and NC). The Eurocodes [12] allow for the application of different types of accelerograms, depending on the available information: recorded, simulated or artificial. In this case, it was decided to use artificial accelerograms generated in accordance with the response spectra assigned with the SIMQKE-1 software (SIMulation of earthQuaKE ground motions) [148] and considering the following requirements from Eurocode 8 [12]:

- the artificial accelerograms shall be generated to match the elastic response spectra concerned for 5% viscous damping ($\xi=5\%$);
- the duration should be consistent with the magnitude and other characteristics by setting the a_g value;
- when not specified in the site-data, the minimum duration of the stationary part T_s of the accelerogram should be equal to 10s (defining a trapezoidal shape with a stationary part of 10s and a total duration of 25s).
- in the interval between $0.2T_1$ and $2T_1$, where T_1 is the fundamental period of the structure in the direction in which the accelerogram is applied, no value of the mean elastic spectrum ($\xi=5\%$), calculated from all time histories, should be less than 90% of the corresponding value of the elastic response spectrum;
- the average of the response acceleration values of zero-period spectra should not be less than $a_g S$ for the interested site;
- at least three accelerograms should be used.

The analyses were carried out with 7 accelerograms compatible with the spectrum for each limit state considered (21 TH analyses). However, instead of evaluating the mean effects on 7 values, all the results obtained were analysed and compared before and after renovation to verify the results obtained so far and further investigate the LS NC. The accelerograms were then combined and applied along the two main directions. Figures 109-111 are three examples of accelerograms for the three considered limit states.

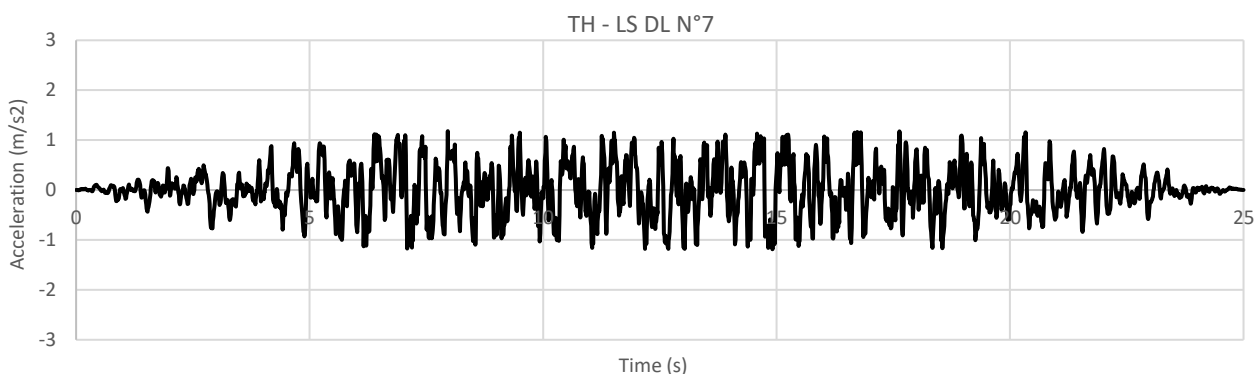

Figure 109 – Artificial accelerogram at the LS DL for the analysis TH7-DL

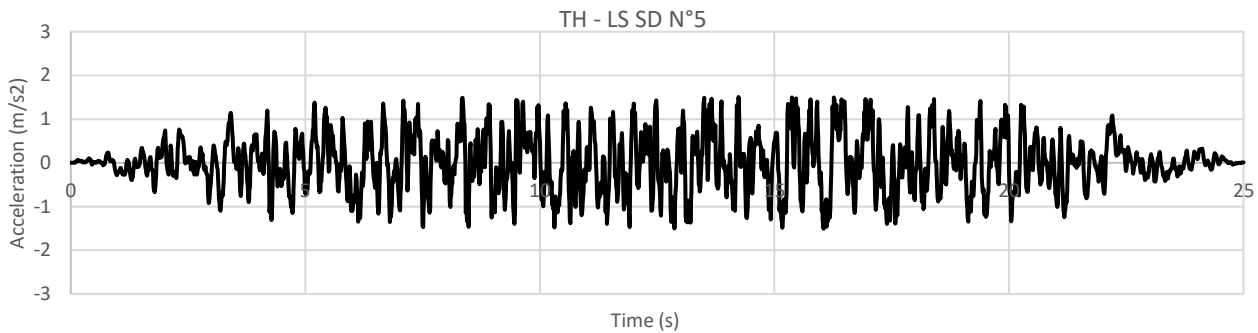

Figure 110 – Artificial accelerogram at the LS SD for the analysis TH5-SD

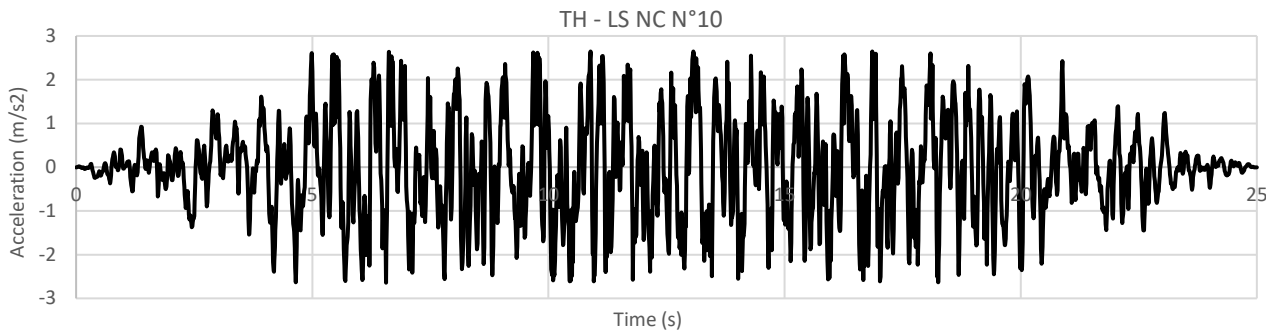

Figure 111 - Artificial accelerogram at the LS NC for the analysis TH3-NC

Damping definition

The dissipation is included in the definition of non-linear plastic hinges of structural elements; dissipative devices have not been included. The structure dissipates energy through various mechanisms, which are taken into account by viscous damping (equivalent linear viscosity). When a structure is damaged, it dissipates energy through plastic mechanisms. This energy is quantified as the area subtended by the hysteretic cycle obtained from the force-displacement (moment-rotation) law of plastic mechanisms (Figure 108). In linear dynamic analyses this is considered with a damping value of 5% when plotting the response spectra. In TH analyses performed with a direct integration method, the same dissipation is considered through Rayleigh damping. The viscous damping mechanisms depend linearly on mass (c_M) and stiffness (c_K) (5.13). As explained in [145], the damping matrix for the j-element is calculated as:

$$C_j = c_M M_j + c_K K_j \quad (5.13)$$

where

- c_M - mass proportional coefficient;
- M_j - mass matrix;
- c_K - stiffness proportional coefficient;
- K_j - stiffness matrix.

The choice of the two coefficients is made in order to approximate a constant damping between percentages of the fundamental period (T_1) equal to $T_b=0.9T_1$ and $T_a=0.2 T_1$. In these period values a critical damping of 5% (ordinate of damping) is set to determine within the software the coefficients, and consequently, the damping.

5.1.4.2 Results

Direct-integration TH analysis is a dynamic analysis method in which the equilibrium equations of motion are fully integrated for each degree of freedom while a structure is subjected to dynamic loading. The analysis

provides the integration of structural properties and behaviour in a series of time steps constituting the histories of accelerations. The equation of motion, integrated at each time step of the input recording (usually every hundredth of a second), regardless of the output increment, is as follows (5.14):

$$M\ddot{u}_t + C\dot{u}_t + Ku_t = F_t \quad (5.14)$$

The resulting matrix system involves masses (M), damping (C), stiffnesses (K) and external forces (F_t), with \ddot{u}_t , \dot{u}_t and u_t that represent acceleration, velocity, and displacement respectively at the time step considered. The analyses were finally performed with SAP2000 [129].

Seven TH analyses were performed for each limit states in order to assess the behaviour of the structure:

- as proposed in [113], from the results of the pushover analyses; the target displacement limits for the LS DL have been set as verification limit for the displacements of the centre of mass at the roof level over time, resulting from the NLDAs for the same limit state (Figures 112-118);
- the state of all non-linear hinges (force and displacement controlled) was checked at the LS SD and NC before and after the application of the exoskeleton for all the NLDAs performed, in order to verify the response of the structure and the presence of failures (Figures 119-121).

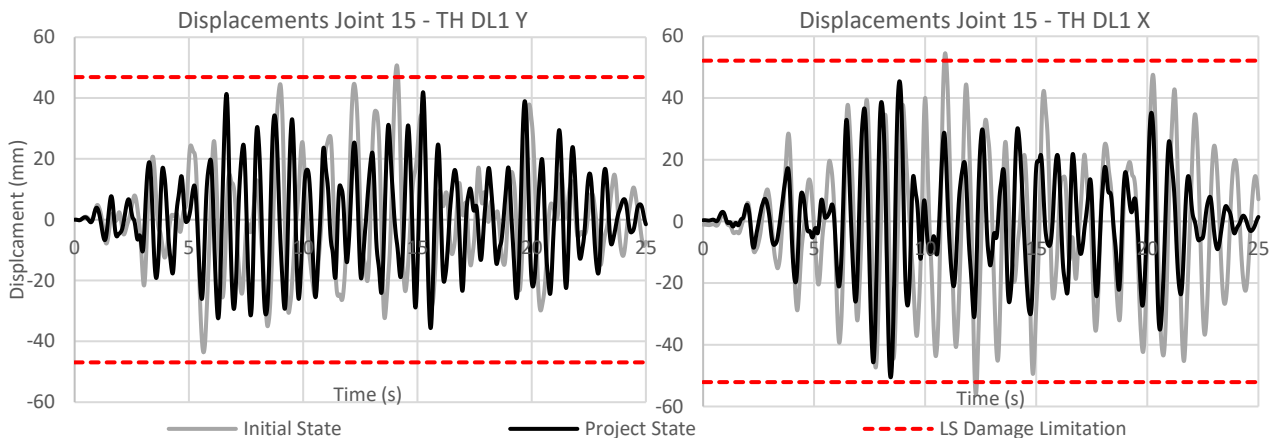

Figure 112 – Displacements over time of the centre of mass of the roof (Joint 15) for the TH DL1 in both directions, and before and after the application of the exoskeleton, also reporting the target displacement limits related to LS DL

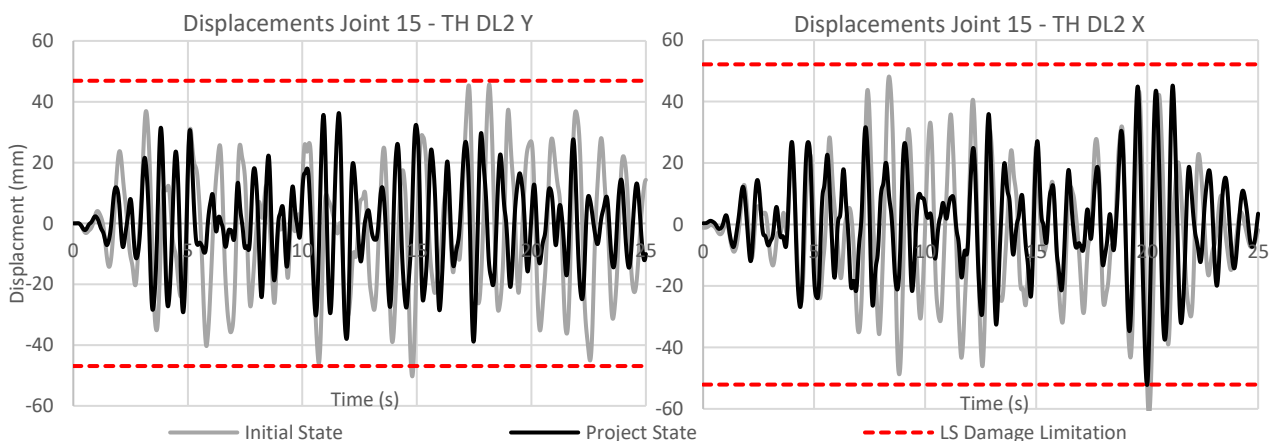

Figure 113 – Displacements over time of the centre of mass of the roof (Joint 15) for the TH DL2 in both directions, and before and after the application of the exoskeleton, also reporting the target displacement limits related to LS DL

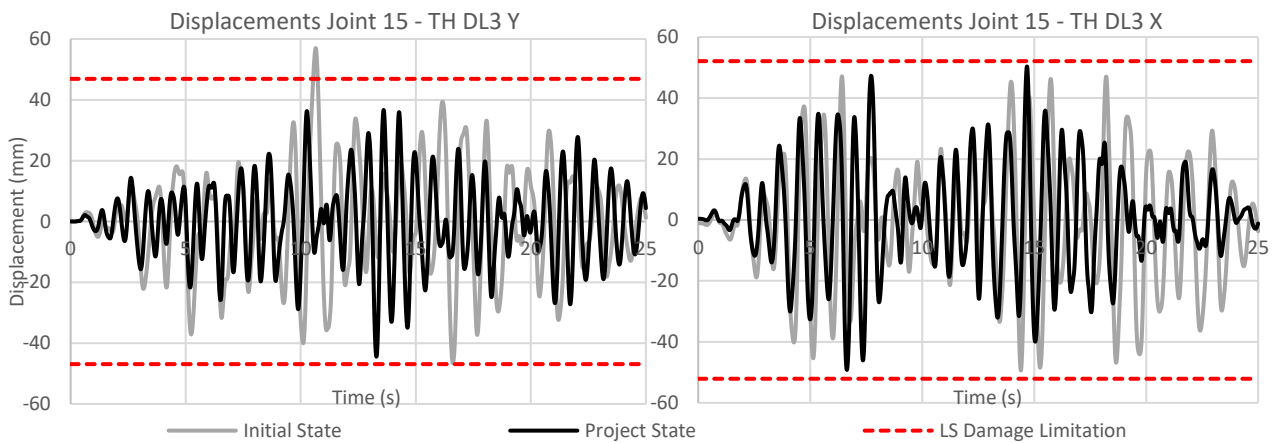

Figure 114 – Displacements over time of the centre of mass of the roof (Joint 15) for the TH DL3 in both directions, and before and after the application of the exoskeleton, also reporting the target displacement limits related to LS DL

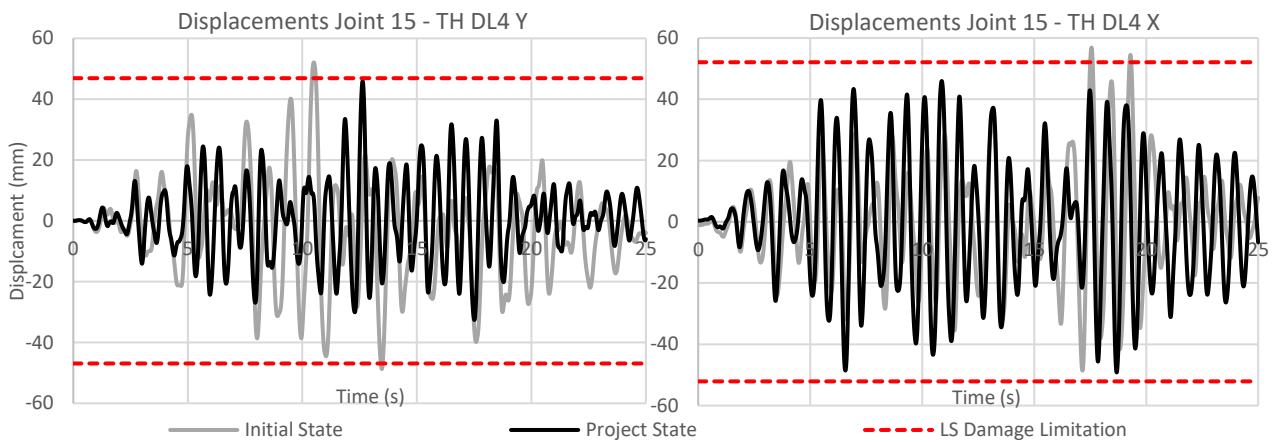

Figure 115 – Displacements over time of the centre of mass of the roof (Joint 15) for the TH DL4 in both directions, and before and after the application of the exoskeleton, also reporting the target displacement limits related to LS DL

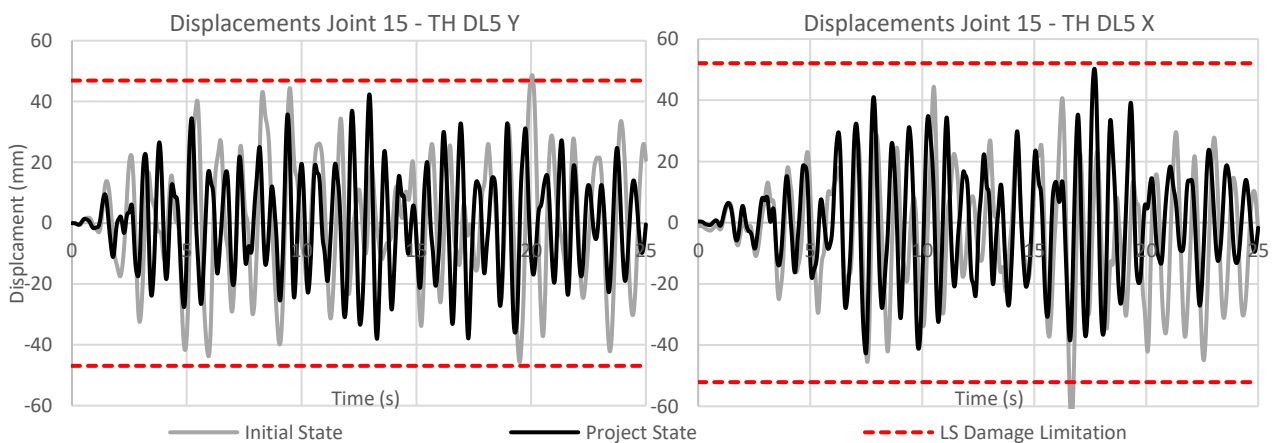

Figure 116 – Displacements over time of the centre of mass of the roof (Joint 15) for the TH DL5 in both directions, and before and after the application of the exoskeleton, also reporting the target displacement limits related to LS DL

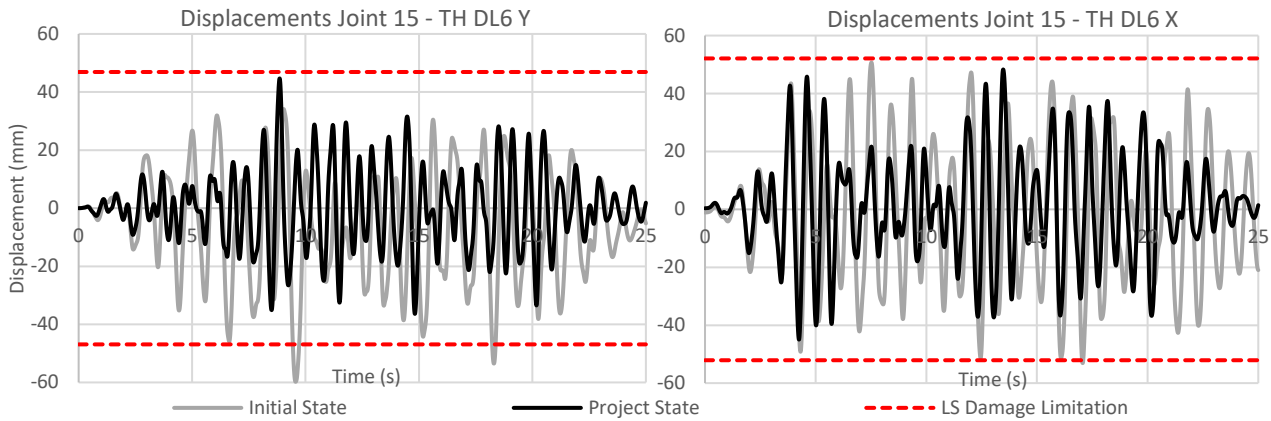

Figure 117 – Displacements over time of the centre of mass of the roof (Joint 15) for the TH DL6 in both directions, and before and after the application of the exoskeleton, also reporting the target displacement limits related to LS DL

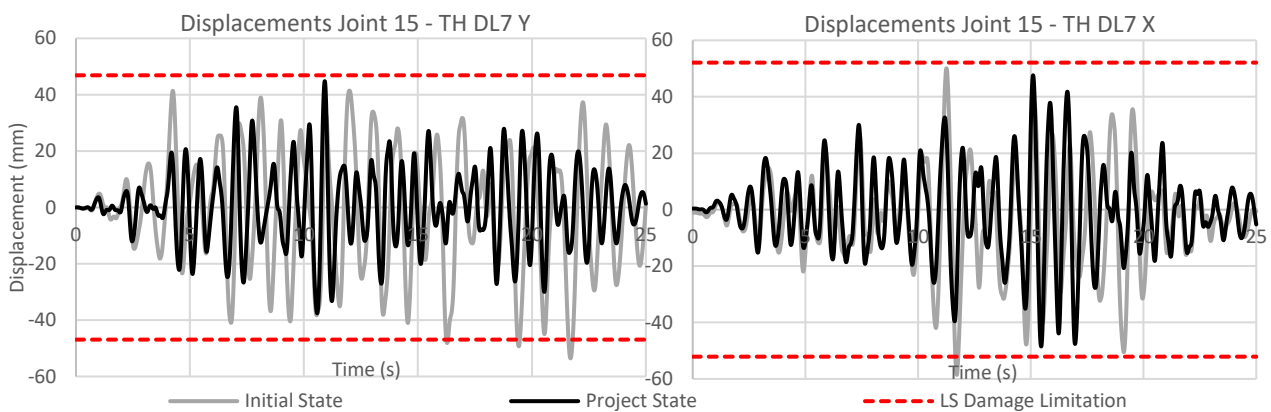

Figure 118 – Displacements over time of the centre of mass of the roof (Joint 15) for the TH DL7 in both directions, and before and after the application of the exoskeleton, also reporting the target displacement limits related to LS DL

As found for the linear and static non-linear analyses, a LS DL vulnerability (grey lines exceeding the red target displacement resulting from the TDVs) was also found for the NLDAs, which is resolved with the application of the exoskeleton.

TH NC1 – Non-linear hinges status (25 s)

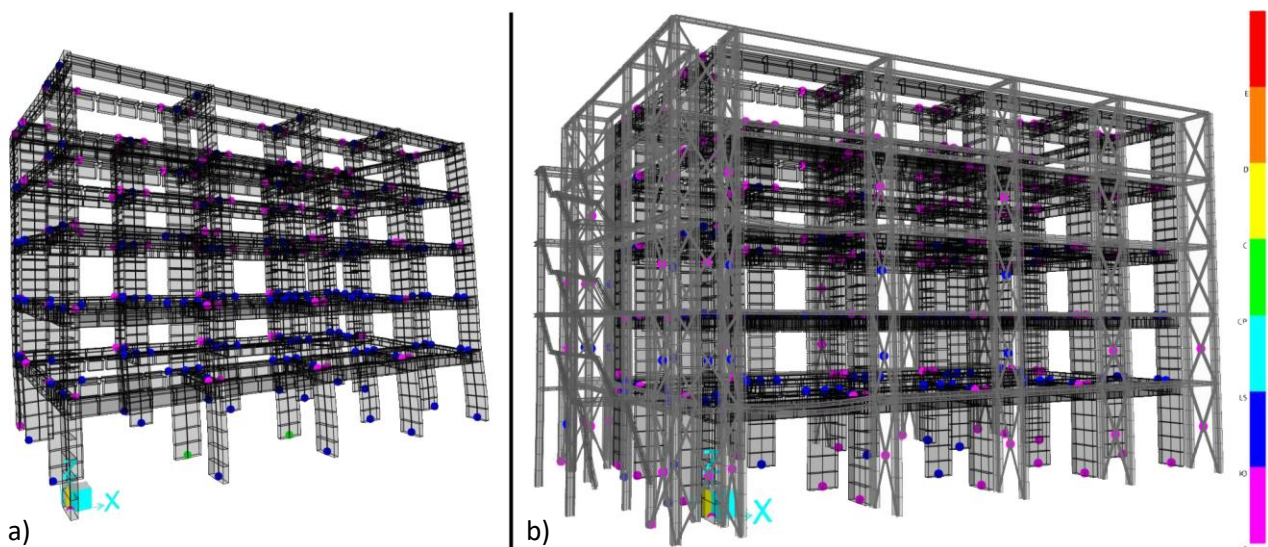

Figure 119 – Non-linear hinges state at the end of TH-NC1 for initial (a) and project (b) state; the colour scale on the right represents the state: blue represents LS DL, cyan LS SD and from green (included) onwards is LS NC

TH NC6 – Non-linear hinges status (25 s)

Figure 120 – Non-linear hinges state at the end of TH-NC6 for initial (a) and project (b) state; the colour scale on the right represents the state: blue represents LS DL, cyan LS SD and from green (included) onwards is LS NC

TH NC7 – Non-linear hinges status (25 s)

Figure 121 – Non-linear hinges state at the end of TH-NC7 for initial (a) and project (b) state; the colour scale on the right represents the state: blue represents LS DL, cyan LS SD and from green (included) onwards is LS NC

While for the LS SD all the analyses resulted satisfied with and without the exoskeleton, at the LS NC three analyses out of seven showed failure of the requirements presenting 3, 6 and 2 hinges over the collapse prevention performance level (Figures 119-121). The strengthened solution with the application of the same ground motions resulted in displacements within the LS DL (blue hinges), thus avoiding reaching even the LS SD with seismic loads complying with the highest requirements (LS NC).

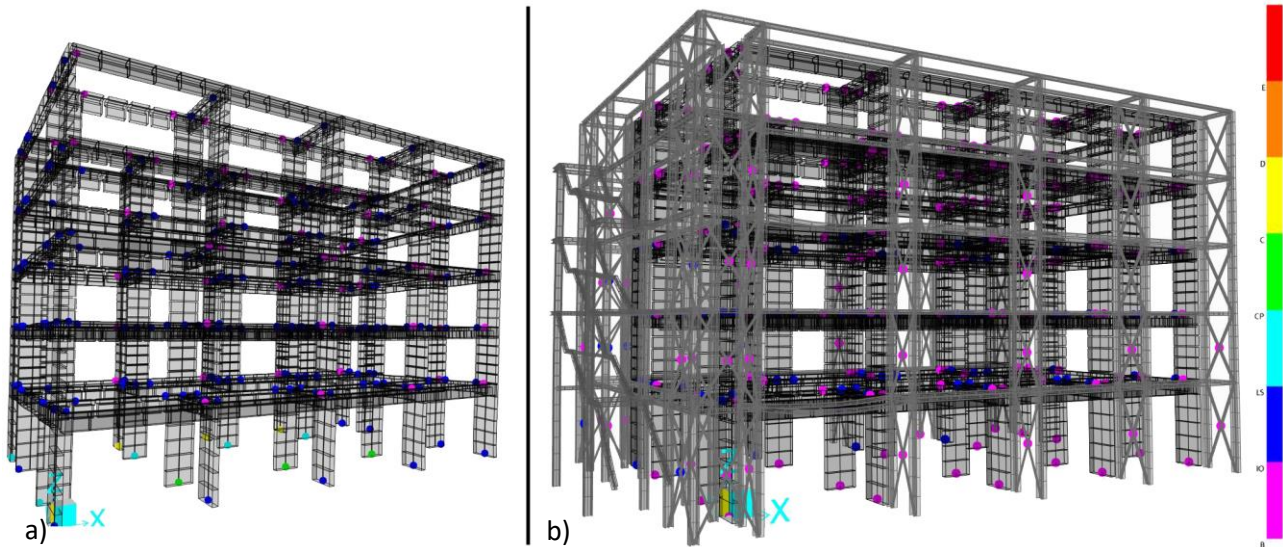
5.1.5 Preliminary design and first assumptions on connections and foundations

During the continuation of the European project, together with the various analyses carried out and presented so far, temporary drawings of the project were produced at a preliminary level of detail in order to consider the structural variable (although not completely defined) alongside the other project components

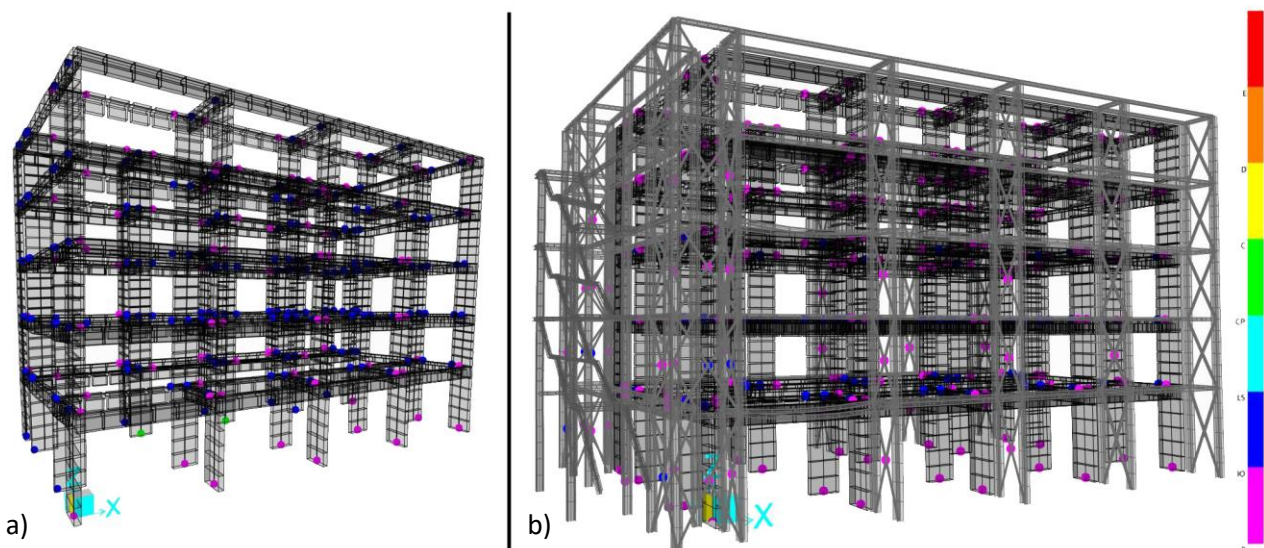
with which it needed to be integrated (energetic and architectural). In fact, to proceed with the selection of the design studios and to move on to the executive phase of the prototype project, involving construction companies and suppliers, it was necessary to develop the whole design hypothesis.

While the EU project is currently at the beginning of the implementation phase in Athens, this section presents the preliminary design solutions of the external steel structures that enabled the development of the whole system (all technical drawings are attached in the Appendix).

Preliminary drawings

Although structural joints are crucial for the definition of a steel structure, as they often govern the selection of one profile rather than another, no verifications of the joints in the steel exoskeleton were carried out, limiting them to stress tests on the profiles used. The solutions provided in the drawings are therefore only a typological indication dictated by the assembly procedures, chosen in accordance with the other prefabricated components. Similarly, the foundations have not been verified due to the absence of precise information on foundations development and actual type and characteristics of the soil. Therefore, this is a qualitative proposal, based on the experience of the consortium members and the advisory board [95], in order to obtain estimated quantities and costs for bill of quantities and other ongoing assessments (e.g. LCA).

In this phase several technical drawings were realised on the basis of the exoskeleton that provides roof extensions as indicated by architectural needs.

- Layout 1 – Assumed foundations for the initial state: it represents the RC foundations of the initial state of the Athens case study. The shape of the existing foundations was given in the technical report [143] provided by the National and Kapodistrian University of Athens, while the development was not indicated and therefore hypothesised for this drawings.
- Layout 2 – Typical plan of the initial state: it represents planimetric development, cross-sections and reinforcement quantities of the RC structure as reported in [143]
- Layout 3 – Transverse vertical cross-section of the initial state: it represents a vertical cross-section of the RC structure based on the dimensions indicated in [143] and double checked with a laser scanner survey conducted by the University of Bologna.
- Layout 4 – Longitudinal vertical cross-section of the initial state: it represents a vertical cross-section of the RC structure based on the dimensions indicated in [143] and double checked with a laser scanner survey conducted by the University of Bologna.
- Layout 5 – Foundations of the steel exoskeleton
- Layout 6 – Detail of the foundations before and after renovation
- Layout 7 – Typical plan of the steel exoskeleton applied to the Athens case study (Figure 122)
- Layout 8 – Plan of the vertical extension: it represents the planimetric development of the steel structure above the existing structure, defining the lower part of the Vierendeel beams.
- Layout 9 – Transverse vertical cross-sections of the steel exoskeleton applied to the Athens case study: two sections are provided to represent the difference due to the presence of different bracings for the reinforced steel frames (RSF).
- Layouts 10 and 12 – Longitudinal vertical cross-sections of the steel exoskeleton applied to the Athens case study
- Layout 11 – Vertical cross-section in proximity of the external stairs attached to the north side of the exoskeleton

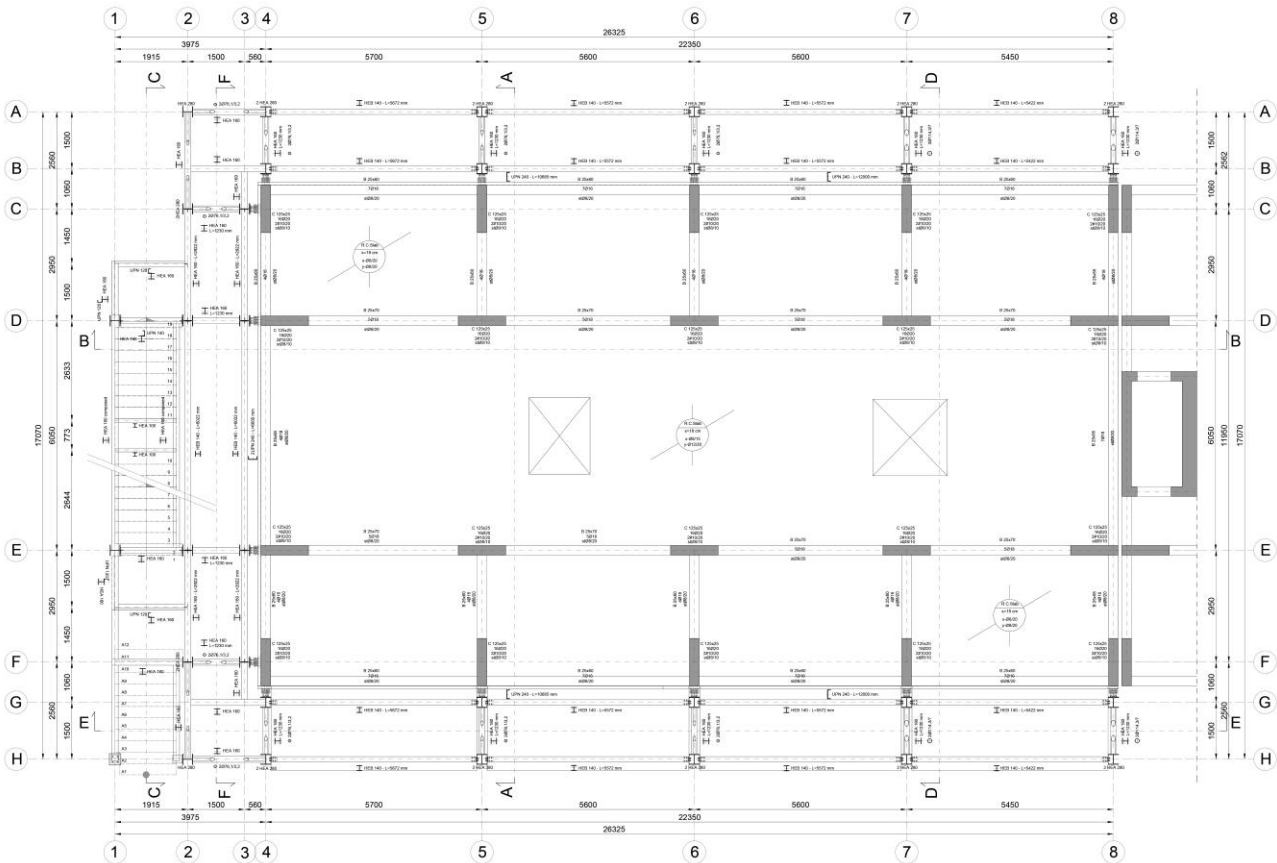

Figure 122 – Typical plan of the steel exoskeleton applied to the Athens case study

Connection to the existing structure

The connection solutions between the exoskeleton and the existing RC structure have been analysed in terms of FEM response in Section 5.1.2, providing two options: hinged connection (HL) and rigid connection (RL).

The hinged connection allows rotation in the plane perpendicular to the existing façade (M3) and should reduce the amount of stresses transferred to the existing structures. It is partly following the best practice of the seismic retrofit of the office building of Magneti Marelli in Crevalcore [109], described above. This type of connection could be more expensive than a rigid joint and must be designed with plates of sufficient thickness to withstand and transfer the axial and shear forces, acting in the transverse and longitudinal direction at each floor. The hinge is realised by means of several thick steel plates supporting a cylinder and fixed on the steel columns on one side and on an UPN-profile connected to the existing RC slabs. The latter is designed to fix several joints along the development of the RC perimeter profiles and slabs, allowing a distributed connection instead of a localised one in proximity of the RC column-beam joints, sometimes heavily reinforced or already in critical conditions. Figure 123 shows the drawings of the solution. Already welded to the UPN perimeter profile, an additional steel plate could allow an easier and more precise positioning of the UPN around a clean and prepared RC surface, thus adding an additional plate to fix the connection either to the top of the beams or, when longer, to the internal RC slabs.

The rigid connections (as done in [54]) consist of a steel profile (rigid in both inertia axes, e.g., pipes or HE) bolted to the exoskeleton by means of flanges and already welded to the UPN profile running along the perimeter. The section of the profile must support and transfer all the loads between the structures and be compatible with the fixation of the UPN profile. This is the closest situation to the simulated rigid joint. It is probably more practicable and feasible in terms of costs and assembly (providing the right tolerances in the holes of the columns), but it brings more stresses to the existing RC joints with a relative lower

exploitation. Finally, the choice between the two options depends on a local analysis of the state of the RC elements in proximity of the joint and the quality of the existing material in relation to the transferred actions.

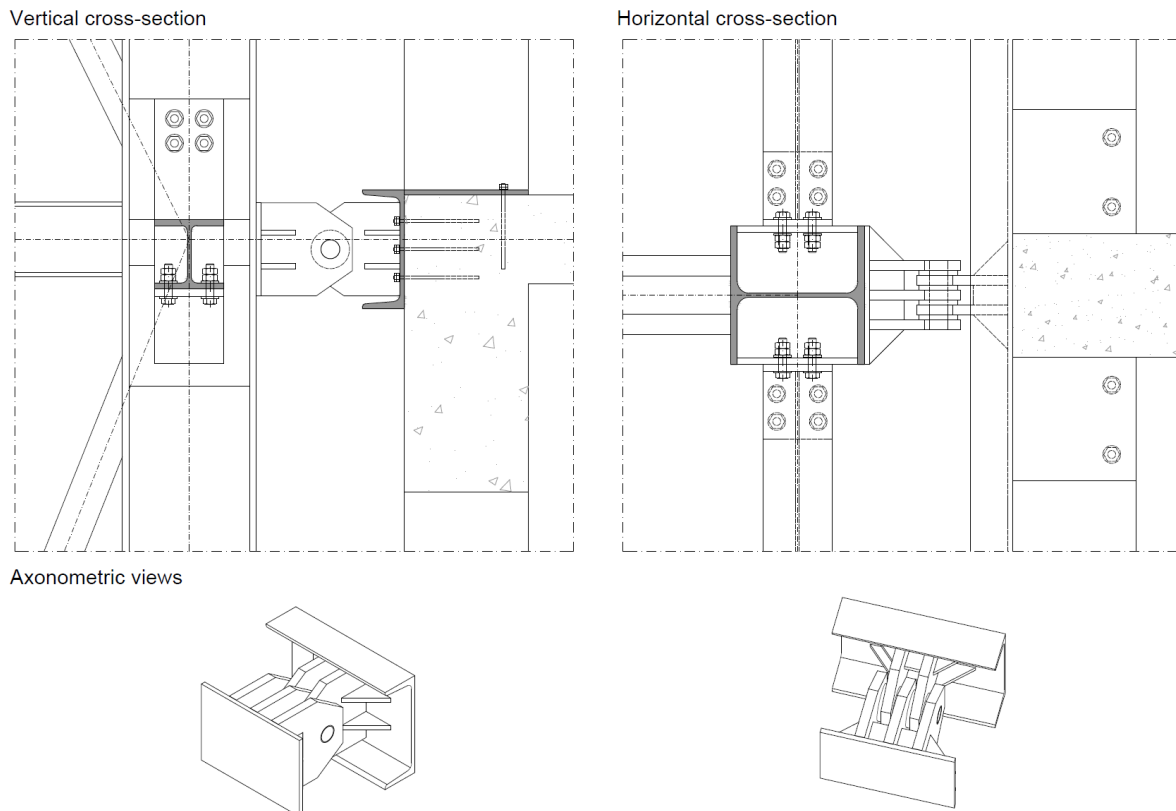

Figure 123 – Drawings of the hinged connection solution provided for the application of the exoskeleton on the Athens case study

Foundations of the exoskeleton

A foundation hypothesis was proposed for the preliminary design in order to roughly start estimating costs, quantities and construction procedures. The proposed solution was discussed among the experts of the project consortium and advisory board of Pro-GET-onE [95] and follows the experience of the retrofit of the Magneti Marelli office building (Figure 124) [109].

During seismic events, the external structure responds to the displacements that occur to the existing structure and is therefore pushed and pulled according to the ground motions. This results in high compressive and tensile forces on the foundations that must be properly transferred to the ground. In order to avoid uplift of the exoskeleton, RC piles or micro-piles are usually adopted to deepen the foundation level and transfer the design loads. The deepening of the foundation level first allows to reach soil layers with better quality and strength and is often combined with the construction of bulbs at the base of the micro-piles to increase the contact surface (Figure 124b). The capacity is then calculated, including both lateral and base contributions, paying attention to the shear forces acting at the pile head which may compromise the effectiveness.

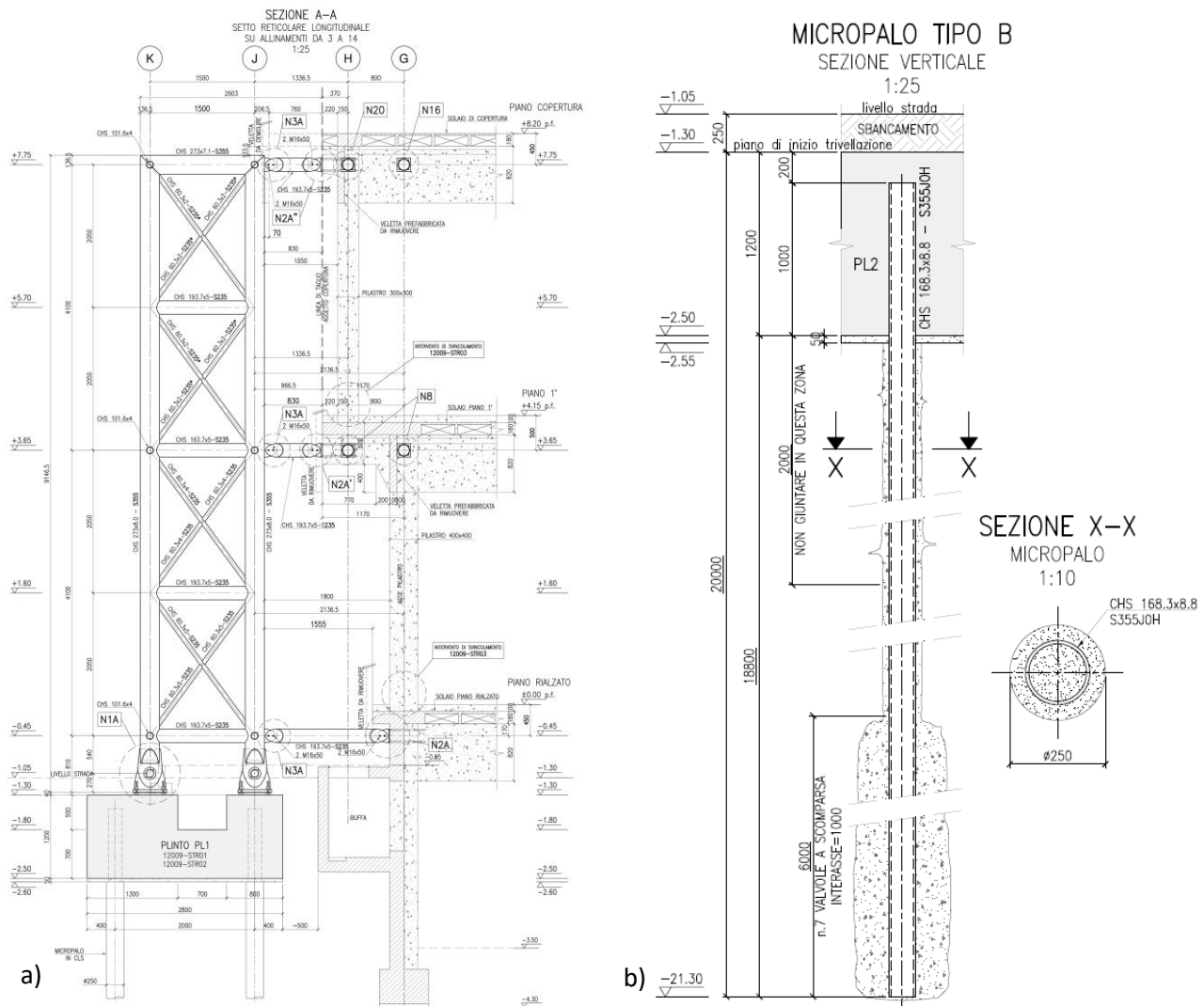

Figure 124 – Technical drawings of the exoskeleton design by TELEIOS Srl for the seismic retrofit of the office building of Magneti Marelli in Crevalcore; a) represents the transverse exoskeleton with related foundations; b) a micro-pile provided below the foundation plates – Source: [109]

The proposed foundation system is separate from the existing one, which, from the limited information available, should have the sections shown in Figure 125b and involves a 0.8m thick RC slab over several micro-piles (four per steel shear wall). The steel reinforcement heads of the micro-piles ($\Phi 180/5$ mm) are connected to each other within the plinths with an IPE-profile and reinforced for 1m at the bottom surface of the RC slabs with spiral bars, in order to avoid local shear failures. The 300 mm diameter micro-piles (considering the outer concrete layer) are then approximately 10 m deep. All the foundation plinths are connected with curbs of the same height of the plinths. Finally, the connection with the steel columns is realised by means of end flanges and anchor bolts (fixed joints). Figure 125 shows the planimetric distribution of the foundations of the exoskeleton and a detailed vertical cross-section of one steel shear walls with related plinths and micro-piles.

An alternative use of hinge connections at the foundation level (as shown in Figure 123) could have made it possible to increase the exploitation of the steel exoskeleton and to transfer a reduced amount of loads to the foundation system.

Assembly phases of the exoskeleton

The assembly of the exoskeleton was assumed in this phase as a project proposal in relation to the other works that concern the installation of the new envelope on the existing building and the insertion of the prefabricated architectural units. The following is a description of the hypothesised procedure for the structural component only. Reference is made to Section 7.1 for further details on the integrated procedures.

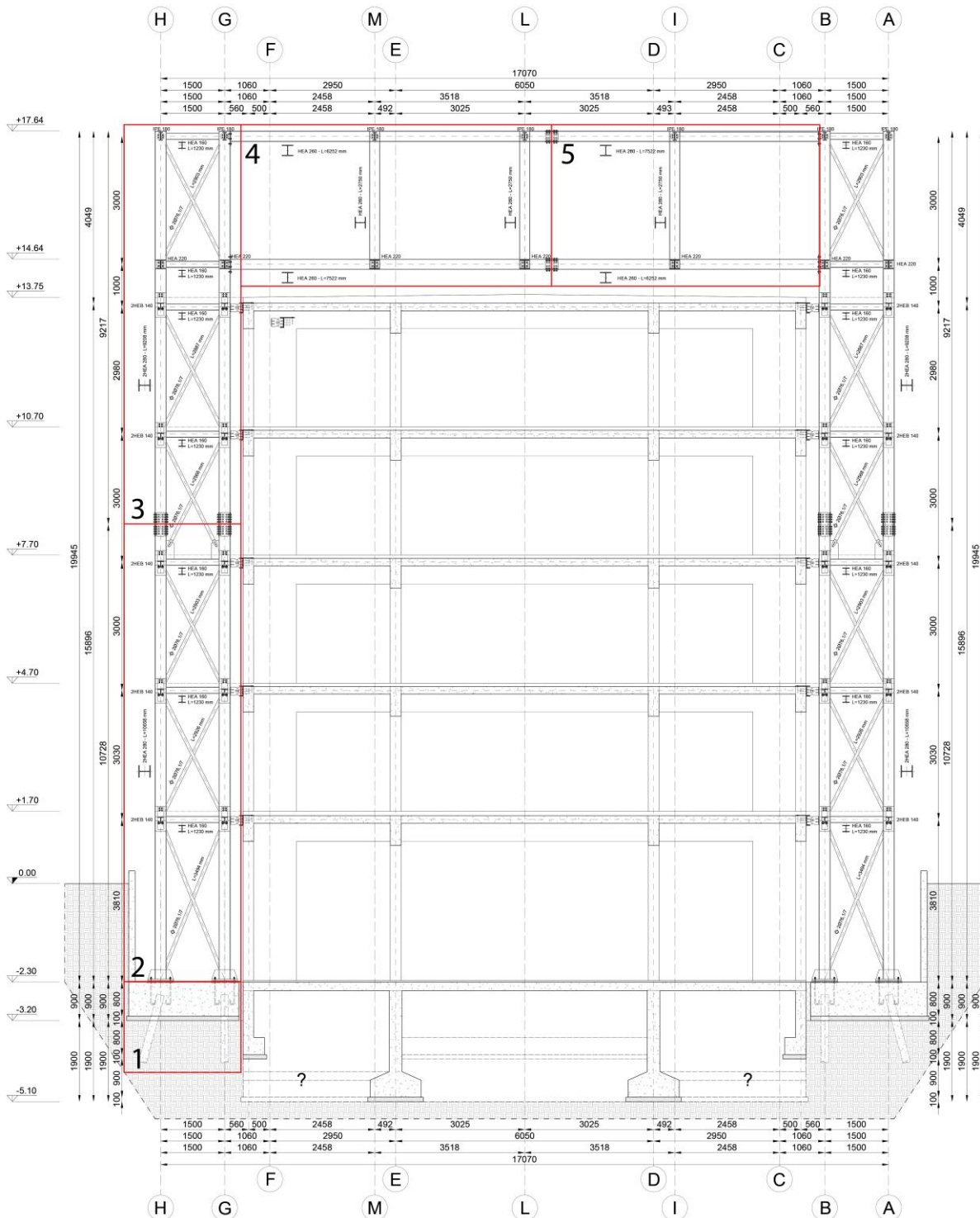

Figure 126 – Vertical cross-section of the strengthened solution with the Vierendeel roof-extension applied on the Athens case study; the red boxes, identified with a number indicate (apart from number one) the macro-elements intended to be prepared and transported to the construction site

- Demolition, excavation, and preliminary works: the demolition of the perimeter infrastructure that surrounds the building is carried out and the façades are prepared. In this phase the balconies are removed, the reinforcements anchored, and any obstacles removed. Using the temporary supports (in any case necessary for the removal of the balconies and the cleaning of the façade) the installation of the perimeter UPN profiles containing part of the connection for the exoskeleton is also planned (Figure 123). Excavations for foundations can start where demolition works have been carried out and partly overlap.
- Construction of the foundations including positioning and casting of the micro-piles, accurate placement of the anchor bolts to complete the formwork and casting of the foundations.
- Portions of the exoskeleton are provided already welded in the workshop and assembled into macro-elements which are then connected directly on site through bolted connections, optimising time and practicality (Figure 126). Starting from the foundations, transverse steel shear walls are prepared up to the third level, a second portion of these walls is then bolted in continuity up to and including the level above the existing building as lateral supports for the Vierendeel beam. The latter is also composed of two separate parts, then assembled closing the transverse frames. The experience of the mock-up within Pro-GET-onE [95] highlighted the importance of adequate tolerances related to prefabrication to overcome irregularities associated with the existing building. The same concept is applicable to the positioning of the anchor bolts at the foundation level as a crucial point for the alignment of the frames to the existing structure and the connections at each level.
- Already after the positioning of the exoskeleton in the first three levels, it is possible to start inserting the longitudinal beams and thus the prefabricated architectural units (further information can be found in Section 7.1.3).

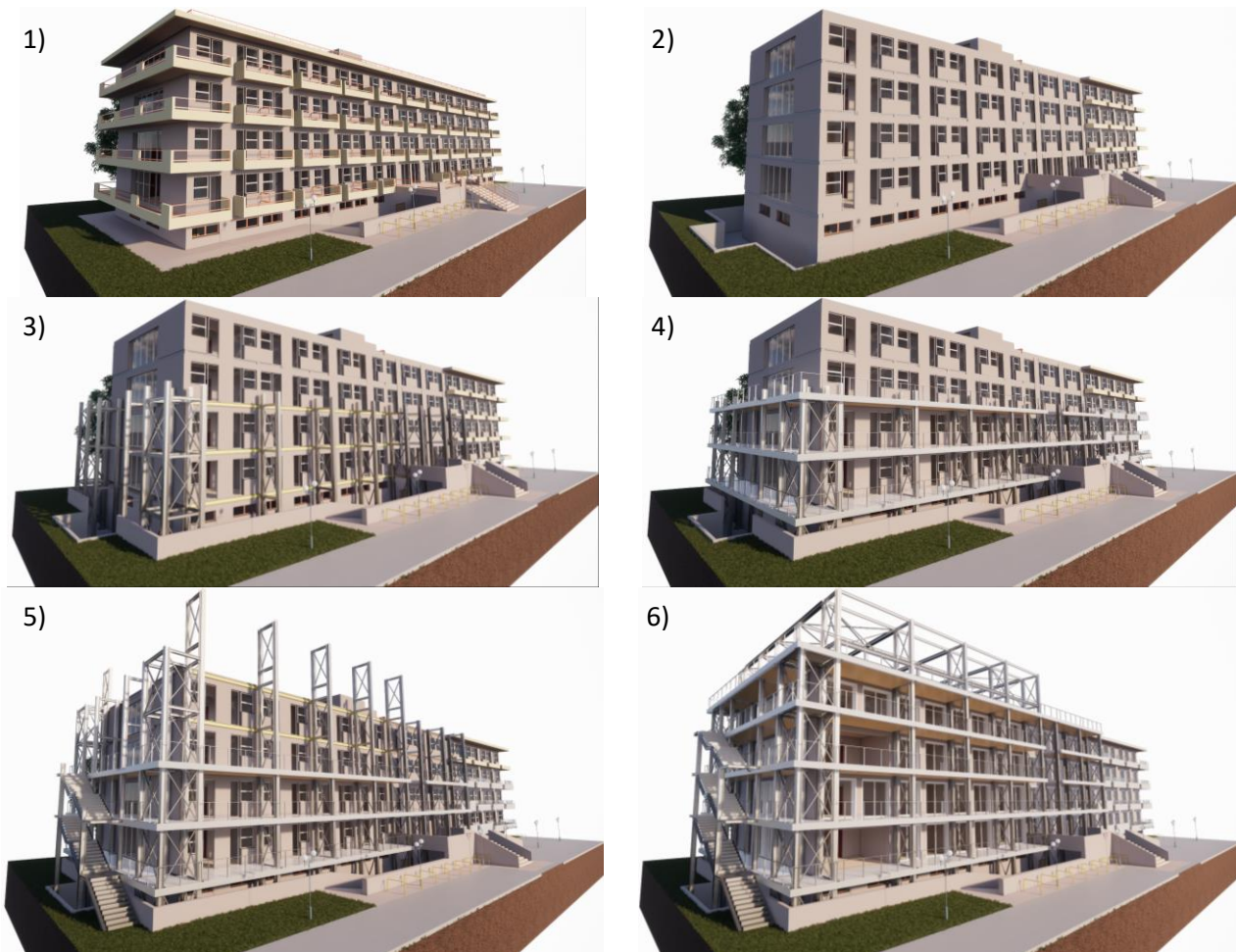

Figure 127 – Assembly procedure of the steel exoskeleton – Source: [142]

5.1.6 Implementations that led to the development of the prototype

During the development of the European project, variations of the external structure were discussed and investigated by the Pro-GET-onE consortium in collaboration with the Greek engineering studio in charge of the structural design. This was followed by a definitive and executive phase of the prototype in Athens, in order to respond to updated structural surveys, compliance with the Greek national standards and to achieve the fulfilment of the seismic requirements [149].

The main modifications foreseen in the executive design and currently provided for the prototype are reported here to complete the chapter, together with some extracts from the related drawings. All the documentation described in this section was made on the basis of the work done by OMITEM SA consulting engineers [149].

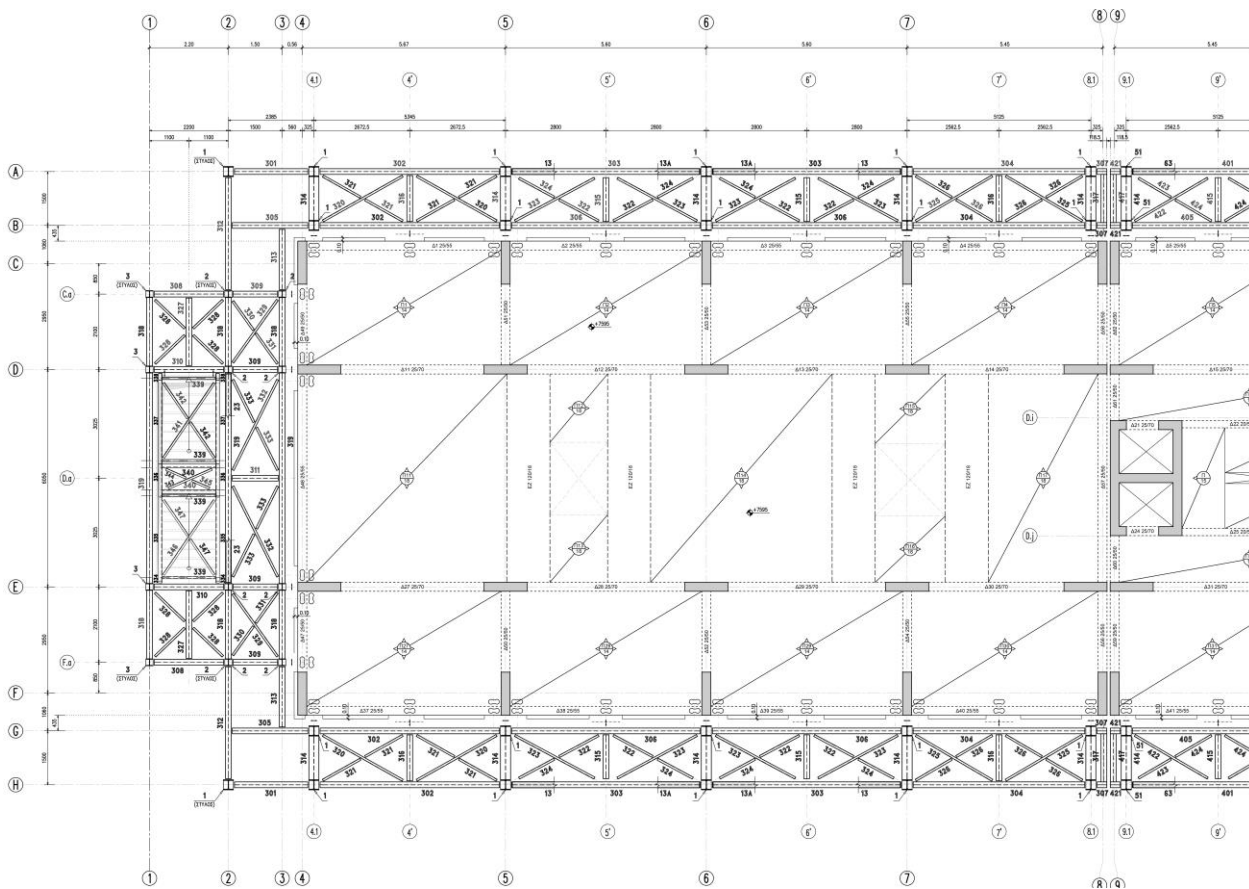
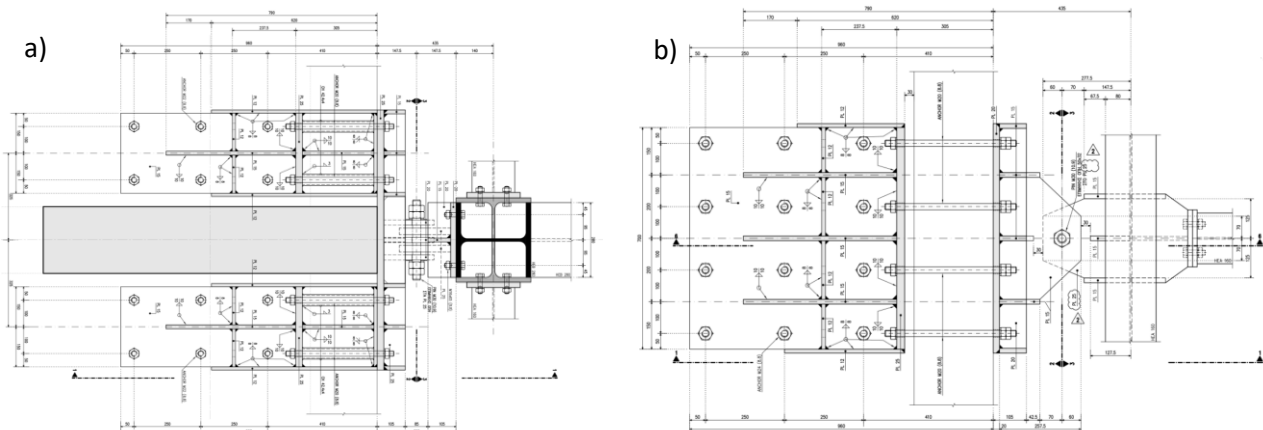

Figure 128 – Typical structural plan of the steel exoskeleton design by OMITEM SA consulting engineers for the seismic retrofit of the Athens student house – Source: [149]



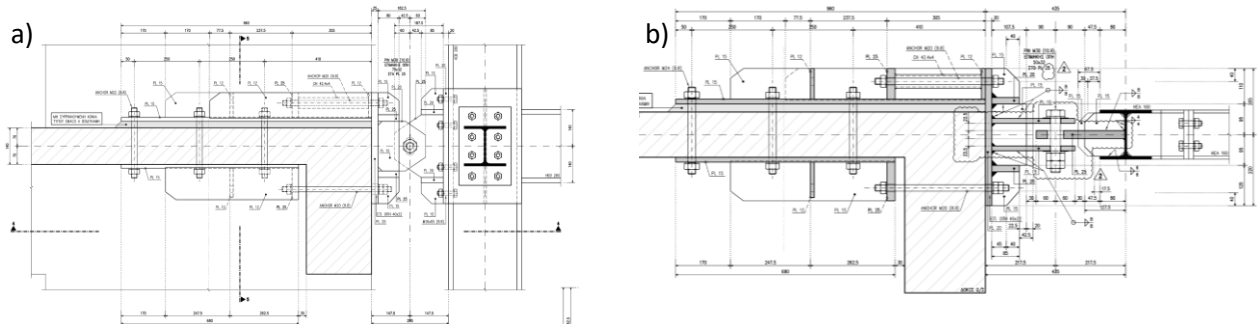

Figure 129 – Technical drawings of the two hinged connections design by OMITEM SA consulting engineers for the seismic retrofit of the Athens student house; a) connection to the RC columns, allowing relative vertical displacements; b) connection at the centre of the RC beams, allowing perpendicular-to-façade displacements – Source: [149]

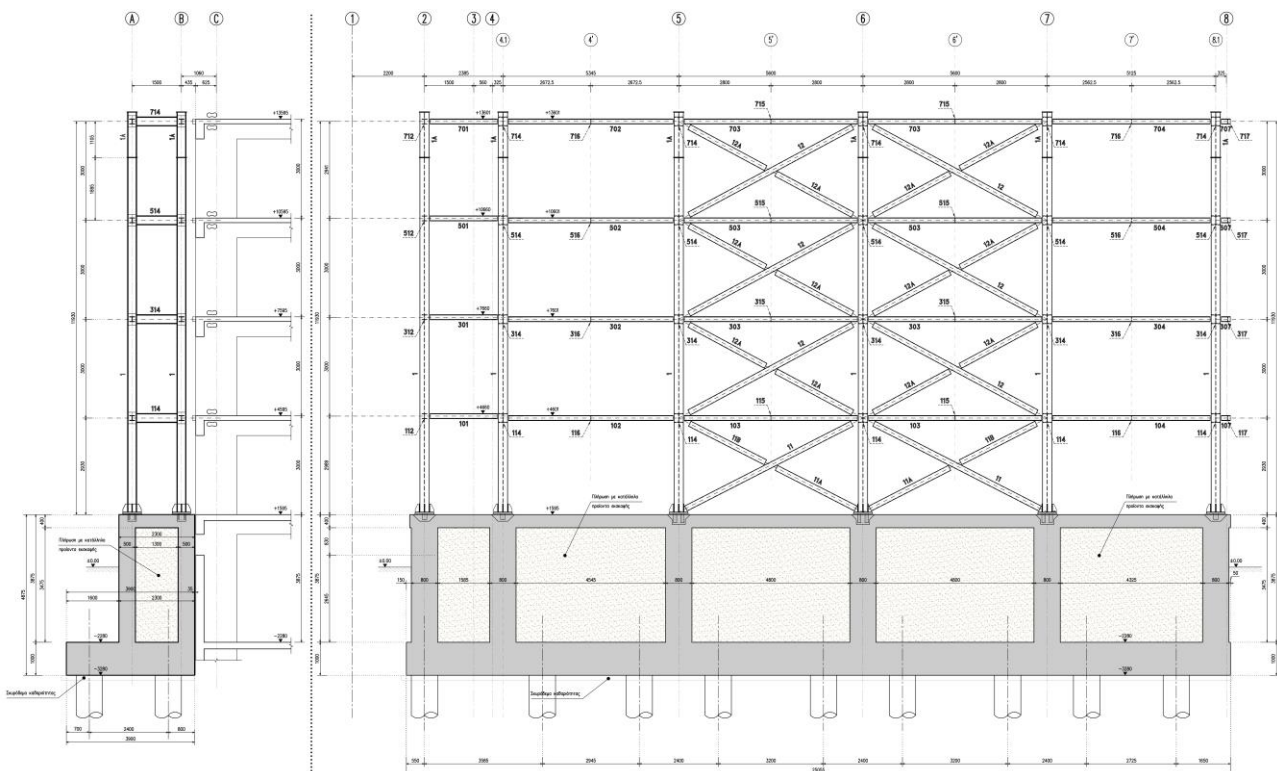

Figure 130 – Technical drawings of the steel exoskeleton design by OMITEM SA consulting engineers for the seismic retrofit of the Athens student house; a) transverse view of the steel moment-resisting frames applied on the longitudinal side; b) façade of the steel structure showing X-bracing in the external longitudinal frames – Source: [149]

Rigid diaphragms have been foreseen in the exoskeleton, realised with horizontal bracing systems between the longitudinal beams. Due to the distance between two transverse steel frames, two X-bracings have been provided for each span (Figure 128).

The connection with the existing structure is obtained by means of hinges. The presence of a rigid floor in the exoskeleton also allowed the placement of an additional hinge in the centre of each bay, increasing the number of joints and better distributing the forces. In addition, the hinges were provided with tolerances to allow relative displacements not previously considered. The hinges connected near the columns are designed to transfer only axial loads, allowing a relative vertical displacement between the exoskeleton and the existing structure. On the other hand, the hinges connected at the centre of the RC beams transfer the shear forces to the slab and allow perpendicular displacements to the façade to avoid loads concentrated in the centre of the existing RC beams. The hinges are composed by several steel rigid plates and conservatively designed to rely only on the compressive strength of the existing RC members and therefore avoiding chemical anchorages. The latter were foreseen in the solution exposed in the previous sections and

confirmed by many references, as described in Chapter 4. The connection proposed by the executive design of the Greek engineering studio imposed the positioning of steel plates inside the existing units, directly connected by bolts with the external plates (Figure 129).

The positioning of the bracing was modified. In transverse direction the increase of cross-sections of the horizontal beams made it possible to remove the transverse X-bracing, relying on the moment-resisting steel frame, strengthened by an additional half-member (HEB280), positioned near the ends of the longitudinal beams to increase the stiffness of the steel joints and allow a more rigid and practical connection of the beams (similar to what is proposed in Figure 123). On the other hand, not providing bracing within the steel frames in the short side and corner of the exoskeleton forced the engineers to place it in two bays of the façade as shown in Figure 130, with a consequent worsening of aesthetic and practicality in the assembly procedures.

The foundations were designed with two piles instead of the four micro-piles previously proposed. Furthermore, in order to solve possible problems related to the water management and to avoid worsening caused by the removal of the soil, which modifies the zero level for the existing structure possibly amplifying the displacement demand, the foundations were composed of high walls, flanking the existing underground structure and reaching the first floor, reducing the height of the exoskeleton by one floor.

Despite the proposed modifications, the analyses carried out by the Greek engineers foresaw the insertion of FRP strips for the existing RC beams in both directions in order to achieve complete fulfilment of the verifications under seismic loads, indicating that the exoskeleton is not able to completely solve the vulnerabilities of existing members. Similar results were found with force-based design approaches (linear dynamic analysis), performed in the previous chapters. In fact, linear analyses are usually more conservative than non-linear approaches.

In particular, FRP strips were provided for shear reinforcement at the end of the beams as a consequence of high end-moments. In fact, especially the beams located in the short direction of the building are connected to the columns along their main direction. These beams receive high end-moments and at the same time are considerably short. Therefore, considering a constant seismic shear along these beams directly proportional to moments and inversely proportional to the length results in very high shear forces, which are normally difficult to verify, according to current rules, even with the application of the external structure. Finally, local vulnerabilities of the existing RC slabs to vertical loads (due to additional data obtained through precise structural survey carried out prior to this final design phase) were evaluated and consequently solved through the insertion of steel stripes at the extrados of the slabs when necessary.

Additional considerations resulting from the discussion with consortium members were addressed at solving problems that affect internal members (when vulnerabilities are coming from horizontal loads) and force designers to intervene directly on the internal members of the structure, compromising the reduction of disruption and consequently one of the main objectives of the project.

- Additional increase of the exoskeleton stiffness would decrease the element end-deformations, and thus the element end-moments and shears. This could potentially solve, or at least substantially minimise the problem.
- Introduction of dampers within the steel exoskeleton would be effective when carefully evaluated. A certain level of deformation on the building is required for the dampers to properly work. It represents the opposite of the suggestion pointed out above. However, the advantage is an addition of energy dissipation capacity to the structure with consequent decrease of seismic forces.
- Non-linear analyses may improve the condition of the RC existing structure by providing less conservative and more realistic results, as also demonstrated in the sections above.

5.2 The Italian case study – an experimentation of structural aluminium

One of the first analyses carried out involving the experimentation of the exoskeleton is reported on the Italian case study. Some considerations subsequently implemented in the Athens case study, which are not applied here, could have improved the effectiveness of the intervention. More in-depth evaluations by varying the structural schemes and types of analysis applied, although necessary, have not been addressed and consequently described for practical reasons of time.

The Italian case study belongs to ACER RE and is located in Bagnolo in Piano, a municipality in the province of Reggio Emilia in the Italian region Emilia-Romagna, situated about 60 km northwest of Bologna and about 8 km northeast of Reggio nell' Emilia. The municipality is about 27 km² with an elevation of 30 m above sea level and a total population of approximately 9'790 people. The case study is a 5-storey social housing stock (Figure 131).



Figure 131 – a) and b) Location and three-dimensional view of the social house in Bagnolo in Piano; c) photo of the mirror building opposite the case study – Source: [140]

The building construction started in 2000, therefore, before the current seismic zoning came into force with the OPCM 2003 [68] and was designed to withstand only vertical loads.

Bagnolo in piano is located in zone III with a reference value acceleration between 0.05 and 0.15 g (Figure 132). As residential building, it belongs to class II with reference to Eurocodes [12] and national standards [138].

Table 85 – Class reference for building – Source: [12]

Class	γ_I	Use of building
I	0.8	Buildings of minor importance for public safety, e.g., agricultural buildings, etc.
II	1.0	Ordinary buildings, not belonging in the other categories.
III	1.2	Buildings whose seismic resistance is of importance, in view of the consequences associated with a collapse, e.g., schools, assembly halls, etc.
IV	1.4	Buildings whose integrity during earthquakes is of vital importance for civil protection, e.g., hospitals, fire stations, power plants, etc.

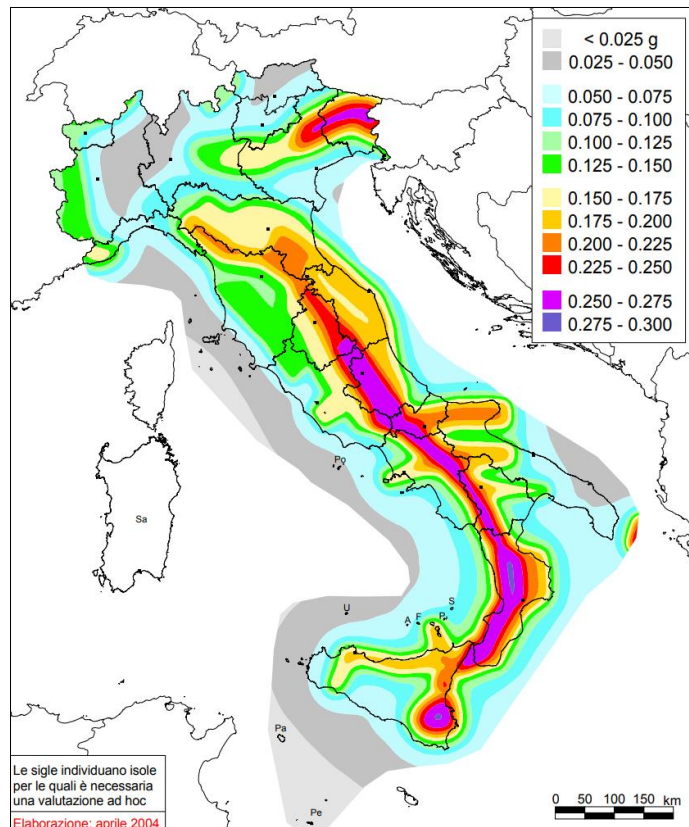

Figure 132 – Seismic risk map of Italy expressed in ground acceleration with 10% probability of exceedance in 50 years according to the seismological data – Source: [150]

The urban compound consists of several independent 4-storey apartment-buildings with attic. Figure 132a shows the cross section, where the net height of each flat is 2.70m. Figure 64b shows the main façade of the building facing south.

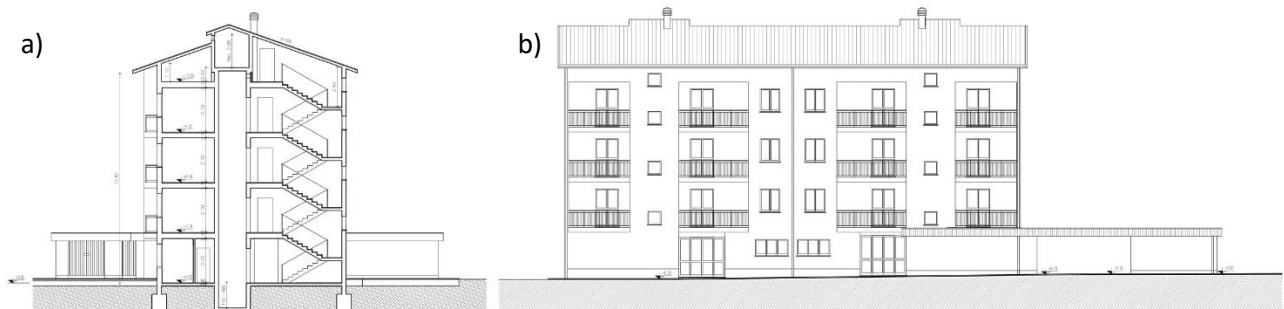

Figure 133 – a) Transverse vertical cross-section; b) South-façade of the building – Source: [151]

The building has a rectangular, L-shaped profile due to the above-ground car park with a southeast orientation. The gross area of the building is approximately 2'300 m² with 13 flats, one on the ground floor (around 48 m²) and four flats on each floor, two of which have an area of 44.5 m² and consist of two main rooms and a bathroom, while the other two have an area of 65.5 m² and consist of four main rooms. Each flat has a storage room and a garage at the ground floor. The flats are accessible by two staircases and two lifts each.

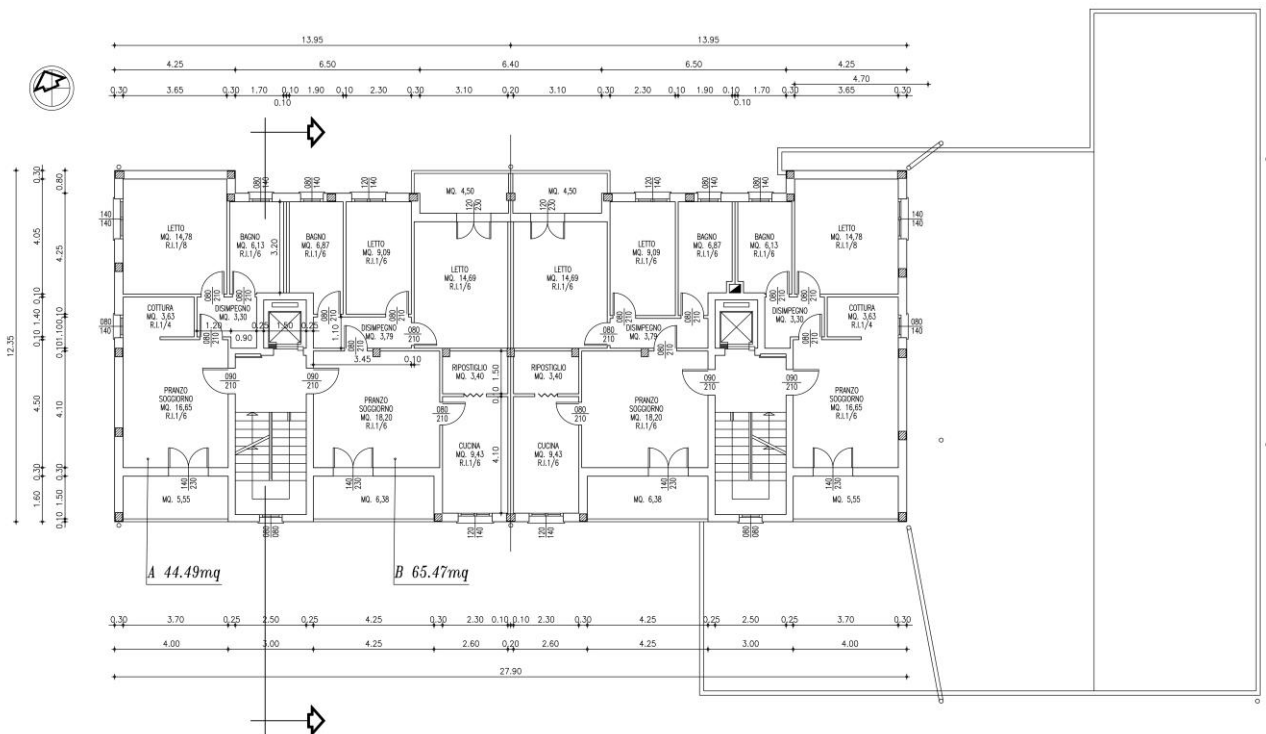

Figure 134 – Typical plan of the Italian case study – Source: [151]

The bearing structure is made of RC moment-resisting frames and masonry bearing walls. RC column-beam frames are connected to the stairwells made of masonry bearing walls. The foundations were designed on a safety load of 1.0 kg/cm². The horizontal structural elements consist of mixed masonry-concrete structure with joists and lightweight flooring bricks for all the storeys apart for the garages, where a *predalles* slab system was provided. It consists of modules of precast components, produced from pre-compressed RC, strengthened with reinforcement, and finally cast on site with lightweight components within the slabs (flooring bricks or polystyrene blocks).

5.2.1 Initial state, before the intervention

The building is a mixed structure with RC frames directly connected with curbs on top of masonry walls supporting stairwells and elevators. The masonry walls hosting the vertical connections act as rigid cores for the structure to which most of the horizontal seismic action is carried. The following data are taken from technical reports and construction drawings, supplied by ACER RE (partner of Pro-GET-onE [95]).

5.2.1.1 Materials

The foundations were built with C20/25 concrete class, while for the columns and beams with C25/30 concrete was used (Table 86). The steel used for the reinforcements refers to outdated Italian technical

standard and is identified as FeB38k, with mechanical characteristics as specified in Table 87. The mechanical characteristics of the masonry walls depend on the type of clay and the type of mortar (Table 88). The masonry bricks are of a perforated type (hollow brick) with a hole percentage of less than 33%, while the mortar refers also to outdated Italian technical standards as class M1/M2 (Table 88). The partial factor γ_M provided for the linear dynamic analyses was not applied for the non-linear static analysis and is equal to 2. In order to consider the complete lack of data from structural surveys and material tests (LK1) a confidence factor (CF) of 1.35 is applied to reduce the strength values of the existing building materials. Finally, a reduction of material's modulus of elasticity E has been considered due to cracking phenomena, as indicated in [138].

- The moduli of elasticity E of the concrete materials defined in the FEM were reduced by 50%
- The modulus of elasticity E of the masonry material defined in the FEM was reduced by 35%

Table 86 – Mechanical parameters of the concrete class – Source: [151]

Concrete class	Weight ($\frac{kN}{m^3}$)	$f_{ck}(MPa)$	$f_{cd}(MPa) = \frac{0.85 \cdot f_{ck}}{CF \cdot \gamma_c}$	$E(MPa)$	$G(MPa)$	ν
C20/25	25	20	8.4	29'962	12'484	0.2
C25/30	25	25	10.5	31'476	13'115	0.2

Table 87 – Mechanical parameters of the steel grade – Source: [151]

Steel grade rebar	$f_{yk}(MPa)$	$f_u(MPa)$	$f_{yd}(MPa) = \frac{f_{yk}}{CF \cdot \gamma_s}$	$f_{ud}(MPa) = \frac{f_u}{CF \cdot \gamma_s}$	$E(MPa)$	ν
Fe B38 k	375	450	241.55	289.86	210'000	0.3

Table 88 – Mechanical parameters of the masonry – Source: [151]

Masonry	$f_k(MPa)$	$f_{vk0}(MPa)$	$\frac{f_k}{CF}(MPa)$	$\frac{f_{vk0}}{CF}(MPa)$	f_{vm0}	$E(MPa)$	$G(MPa)$	
Hollow brick (holes<33%)	$f_b = 30 Mpa$	12	0.3	8.90	0.222	0.317	5'600	1'400
Mortar M1/M2	$f_m = 10 Mpa$							

- f_{ck} - characteristic compressive strength of concrete
- f_{cd} - design compressive strength of concrete
- γ_c - partial factor for concrete
- E - modulus of elasticity
- G - shear modulus
- ν - Poisson coefficient
- f_{yk} - characteristic value of yield strength of steel
- f_u - characteristic value of ultimate strength of steel
- γ_s - partial factor for reinforcement steel
- f_{yd} - design value of yield strength of steel
- f_{ud} - design value of ultimate strength of steel
- f_b - normalised mean compressive strength of a masonry unit
- f_m - compressive strength of masonry mortar
- f_k - characteristic compressive strength of masonry
- f_{vk0} - characteristic initial shear strength of masonry, under zero compressive stress
- f_{vm0} - initial shear strength of masonry to use in non-linear static analysis
- CF - confidence factor
- γ_m - partial factor for masonry to be used in the linear dynamic analyses equal to 2

In order to determine the non-linear material behaviour of the masonry, the stress-strain diagram was obtained based on the characteristics of the mortar and the clay hollow bricks. With reference to [152], it was possible to obtain six points (Table 89) that define the masonry behaviour as shown in Figure 135.

Table 89 – Stress-Strain curve coordinates – Source: [152]

N°	(x; y)	ϵ_m	f'_m
0	[0; 0]	0	0
1	$[\epsilon_{m1}; 0.33f'_m]$	0.00066	2.4444
2	$[\epsilon_{m2}; 0.75f'_m]$	0.00181	5.5556
3	$[\epsilon_{m3}; 0.90f'_m]$	0.00247	6.6667
4	$[\epsilon_{m4}; f'_m]$	0.00362	7.4074
5	$[\epsilon_{m5}; 0.90f'_m]$	0.00476	6.6667

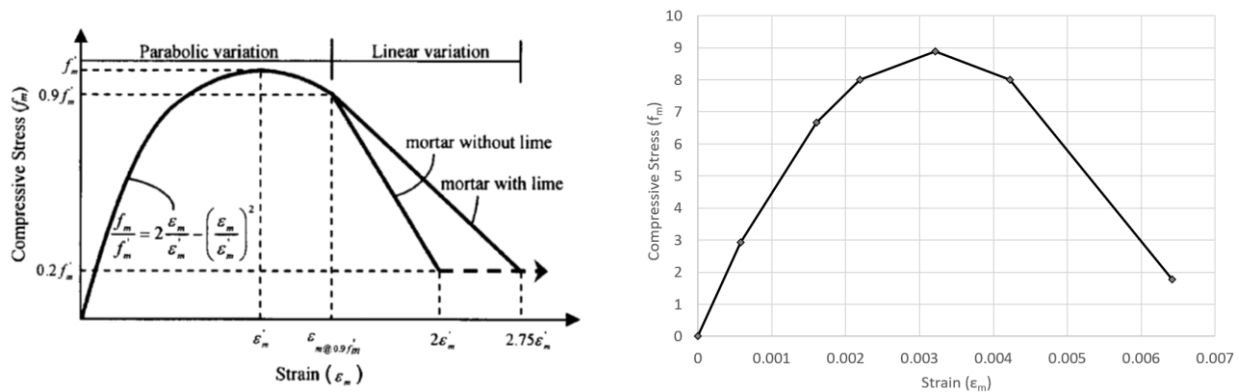

Figure 135 – a) Idealized stress-strain relationship for masonry; b) calculated curve for the customised material used in the FEM for masonry – Source: [152]

5.2.1.2 Structural scheme and characterisation of the members

Based on the structural drawings, two models were created. The first one has masonry bearing walls modelled with shell elements (Figure 136a) and was used for the linear dynamic analysis and the design of the exoskeleton. The second has masonry piers modelled, using frame elements on the basis of the equivalent frame method (Figure 136b) [153]. Non-linear static analyses were then performed on this model to investigate the inelastic behaviour of the structure. In both the models, the RC beams and columns are precisely defined with frame elements having dimensions and reinforcements in accordance with the structural drawings. Examples of these drawings are reported below (Figures 137-141).

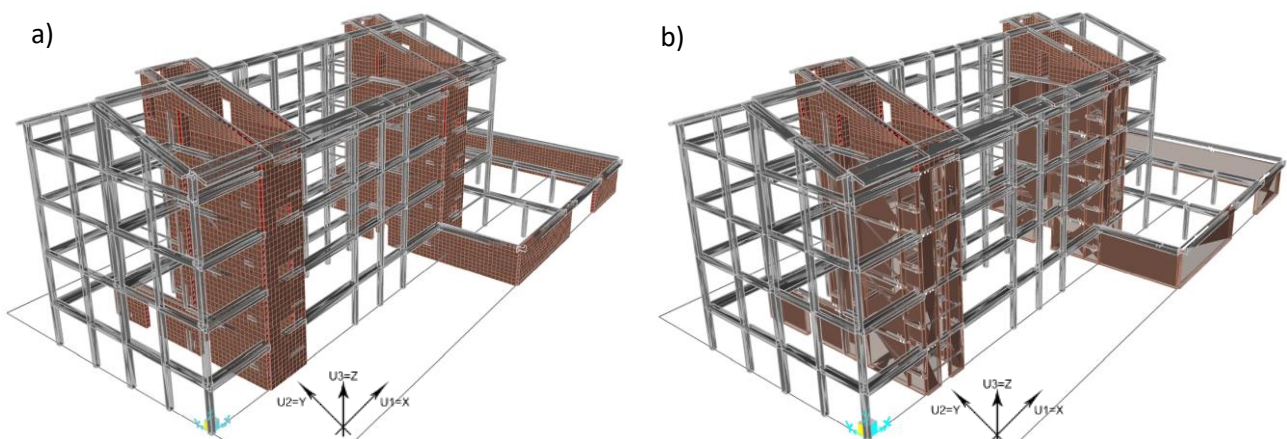

Figure 136 – a) Finite element model with masonry walls modelled with shell elements; b) FEM with masonry walls modelled with frame elements

Two stairwells form the rigid cores of the building and consist of 200-250 mm thick masonry walls. At all storeys, RC curbs interrupt the walls and connect the moment resisting RC frames to the cores. These RC frames run mainly in the longitudinal direction of the building and are designed to carry only vertical loads. In fact, the existing beams have the same height as the slabs and are characterised by low shear strengths. While in the longitudinal direction the masonry piers are short and cooperate with the RC frames, in the transverse direction the contribution of the masonry piers dominates as there are no RC frames in this direction (except for the edge and garages beams). The only connection between the longitudinal frames is therefore provided by the RC slabs. The floors, as specified below, have light masonry bricks and are without continuous RC slabs at the first floor (without considering the garages) and at the roof level, while at the second, third and fourth floor they have a continuous RC slab of 4 cm above joists and hollow bricks. The structure is characterised by a strong irregularity in the arrangement of the columns, while maintaining a basic symmetry for all floors except for the ground floor, where the presence of the garage structures and the longer masonry piers determine a significant torsional behaviour of the structure.

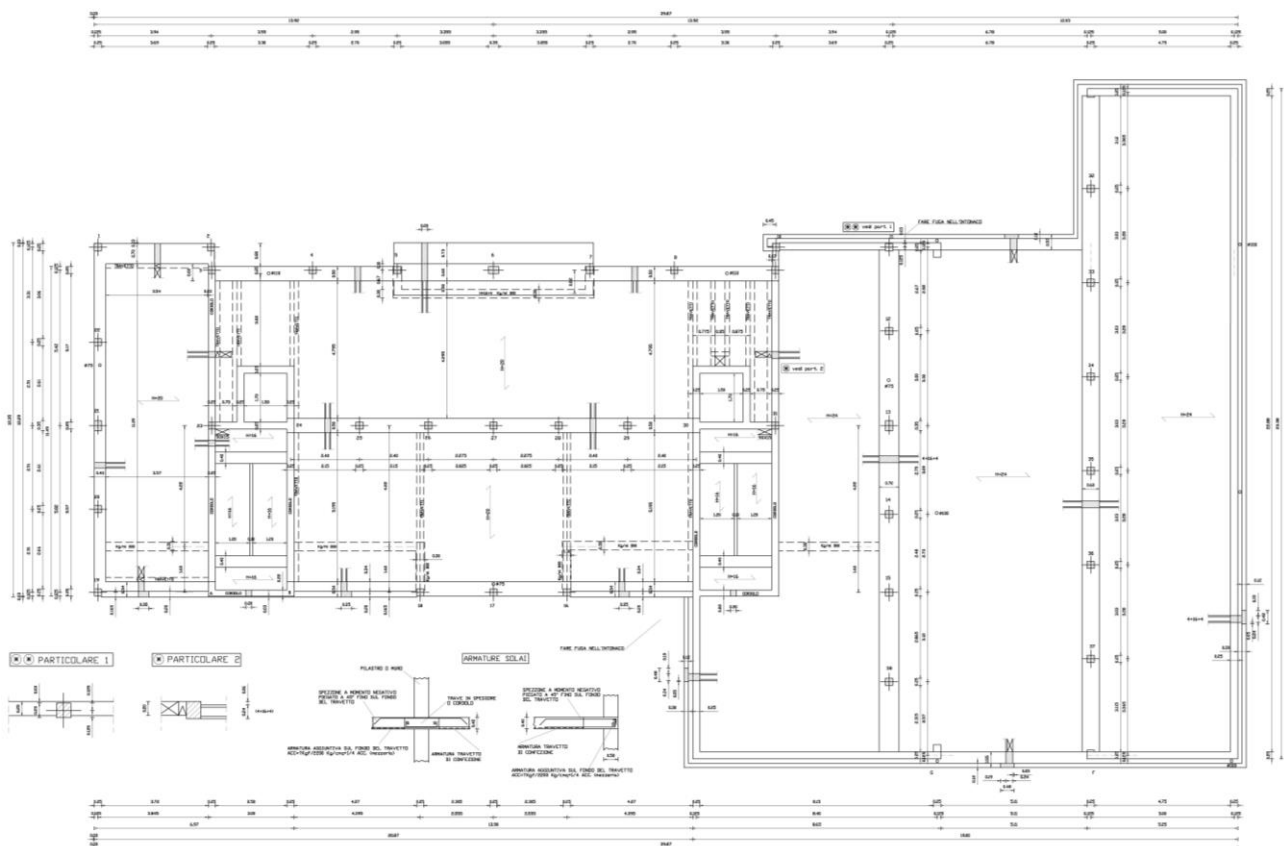

Figure 137 – Technical drawings of the structure of the first floor – Source: [151]

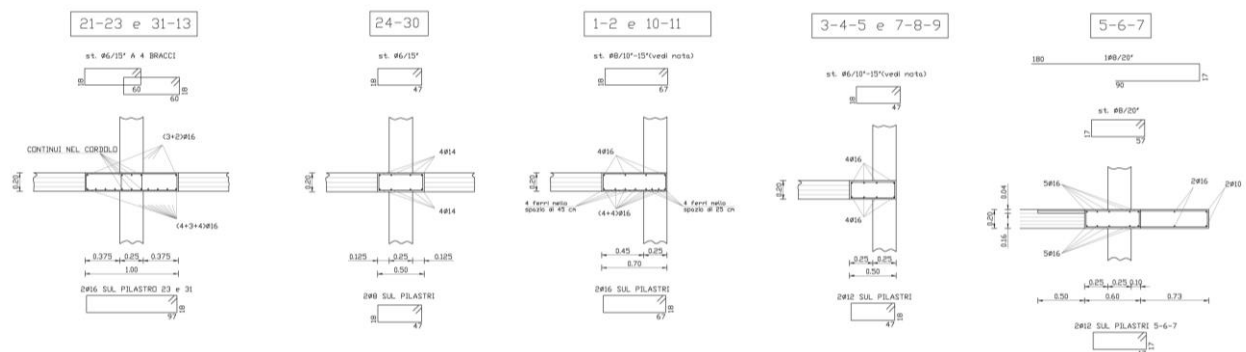

Figure 138 – Technical drawings of the details of some RC beams at the first floor – Source: [151]

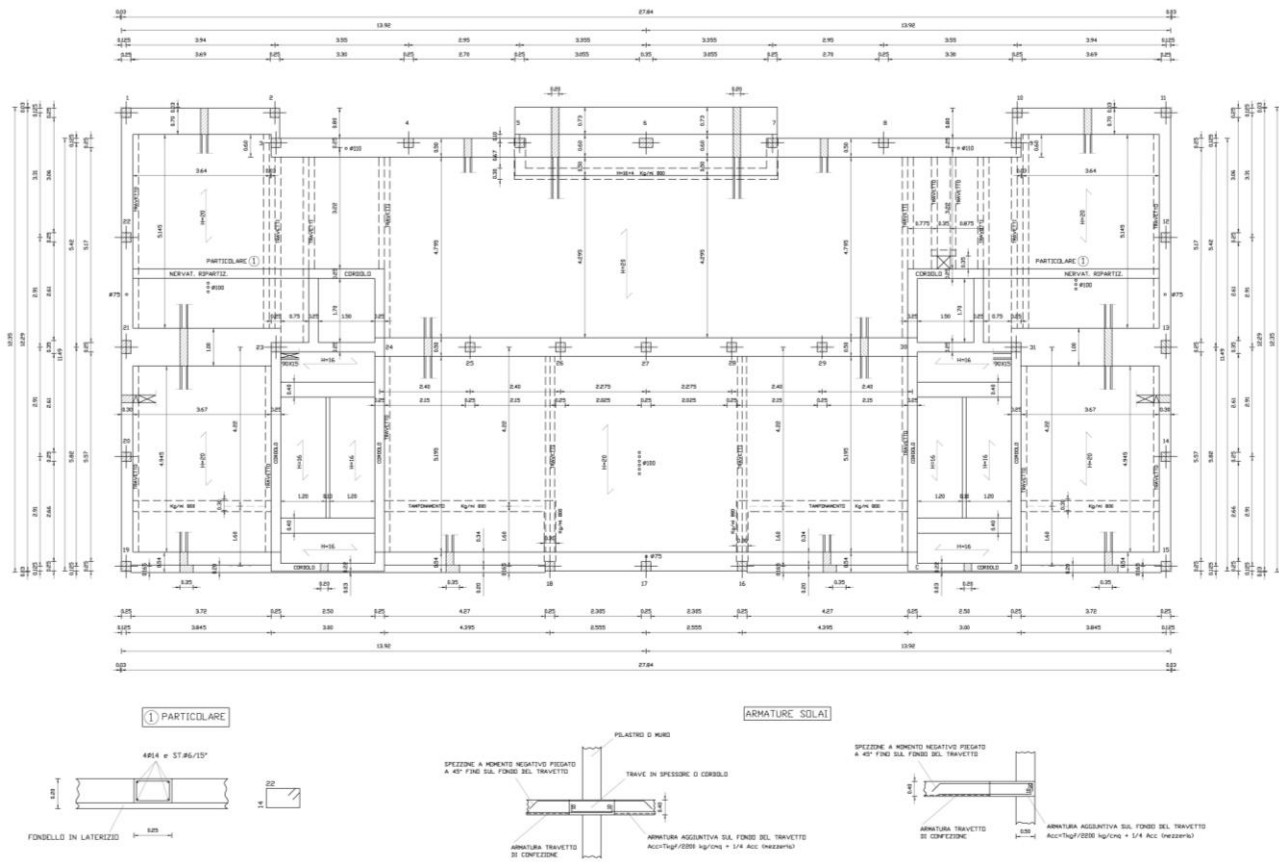

Figure 139 – Technical drawings of the structure of the typical floor – Source: [151]

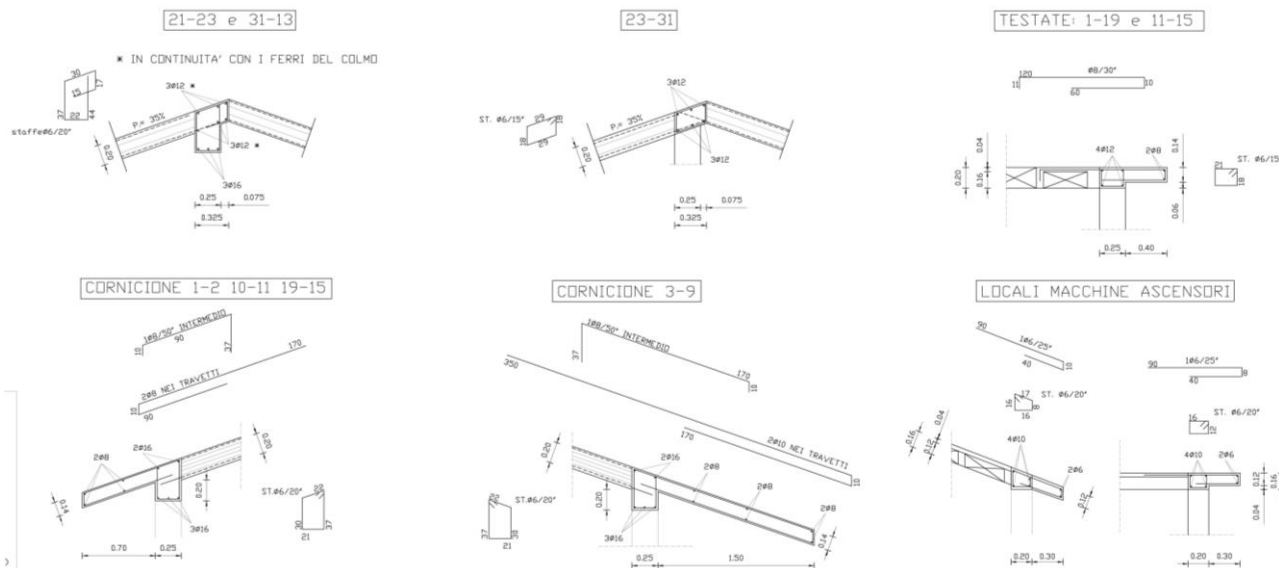

Figure 140 – Technical drawings of the details of some RC beams on the roof – Source: [151]

5. Seismic improvement through the exoskeleton

DOCT. ING. EMILIO BERGOMI: via Guido Rossa n°2
 42100 Reggio Emilia
 tel. e fax 0522/285703

titolo

FABBRICATO A 13 ALLOGGI: VIA LABRIOLA
 BAGNOLO IN PIANO (RE)

committente

ISTITUTO AUTONOMO PER LE CASE POPOLARI
 DELLA PROVINCIA DI REGGIO EMILIA
 Piazza Vallisneri, 4 Reggio Emilia
 Tel. 0522/455377-Fax. 0522/453183

tavola

TAV. N° 4 - TABELLA PILASTRI E PARTICOLARI

data

aggiornamenti

scala

MAGGIO 1999

1:20

4

MATERIALI

CALCESTRUZZO: fondazione $R_{ck} > 250$ kgf/cm²
 elevazione $R_{ck} > 300$ kgf/cm²

ACCIAIO: Feb 38k o Feb 44k (SALDABILE)

MURI VANI SCALA ED ASCENSORI:
 ELEMENTI IN LATERIZIO SEMIPIENI
 percentuale di foratura $< 33\%$ - $f_{bk} > 300$ kgf/cm²

MALTA:

CLASSE M1 (1 parte di cemento + 3 di sabbia)
 CLASSE M2 (1 parte di cemento + 0.5 di calce idraulica + 4 di sabbia)

TABELLA PILASTRI

TON	NUMERO	P.T.	1°P.	2°P.	3°P.	SOTT.
60	21-6-13	25X35 4Ø18	16	14	14	12
50	4-5-7-8 25-26-27 28-29-18 16-23-34	25X25 4Ø18	16	14	14	12
40	1-11-15-19 17	25X25 4Ø16 25X25 4Ø16	16 14	16 14	16 14	16 12
30	2-3-9-10 12-14	25X25 4Ø14 25X25 4Ø14	14 12	14 12	14 12	12
20	20-22	25X25 4Ø12	12	12	12	12
15	38	25X25 4Ø12				
12	32-33-34 35-36-37					
	24-30	MURATURA				

STAFFE
 48/10°-20°(vedi particolare)



PER PILASTRI 25X25

PER PILASTRI 25X35

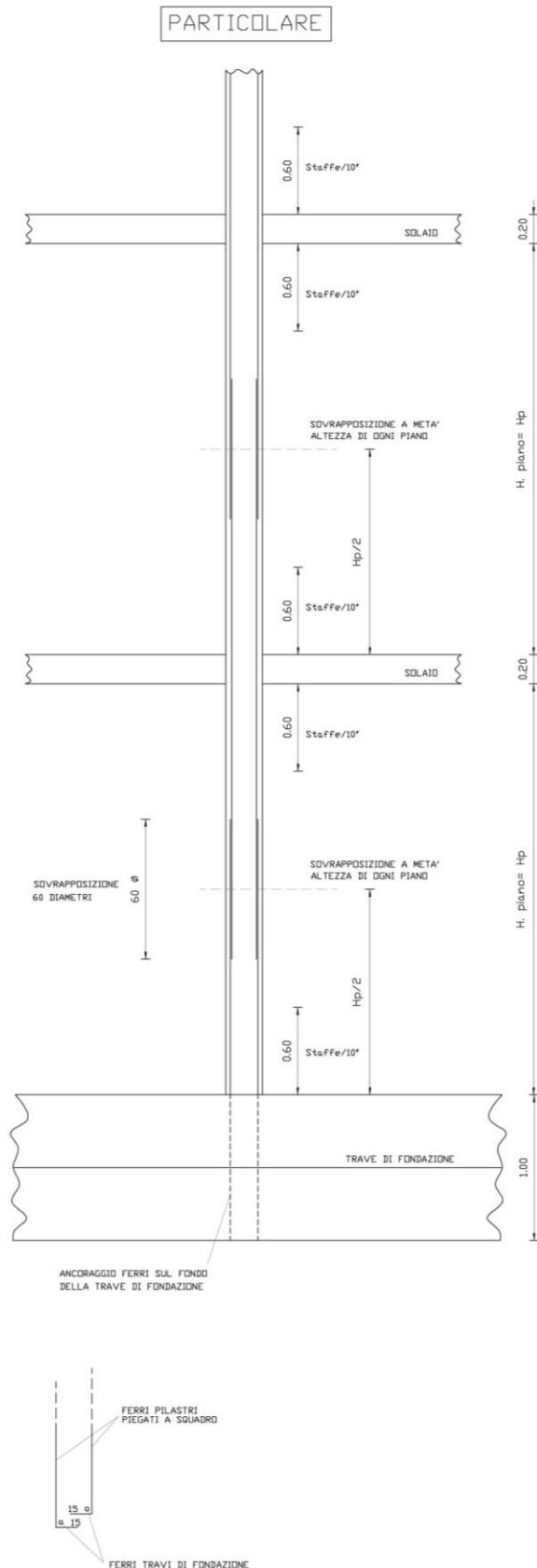

Figure 141 – Technical drawings of the details of the RC columns – Source: [151]

5.2.1.3 Modelling parameters*Load patterns*

The horizontal structures of the main building are made up of concrete slabs with joists and hollow bricks (h = 240 mm for the first slab, h = 200+40 mm for the second, third and fourth floor and h = 200+20 mm for the pitched roof) while the accessory structure is made up of a *predalles*-slabs (h = 40+160+40 mm). The permanent loads used in the analyses are taken directly from the available structural reports [151]. The external walls are made of 300 mm thick hollow bricks and mortar. The following tables show the loads considered in the model (Tables 90 and 91). While the loads on the floors are considered distributed on the areas and transferred to the longitudinal beams, the loads of the external walls are linearly distributed on the perimeter beams of the building.

Table 90 – Load patterns assigned to the floors of the storeys – Source: [138]

Floors			
Hollow brick concrete slab			
	Self-weight	Dead load	Live load
Garage	3.6 kN/m ²	2.7 kN/m ²	Snow = 1.2 kN/m ² ; A = 2 kN/m ²
First/second and third floor	2 kN/m ²	3.3 kN/m ²	A = 2 kN/m ²
Attic floor	2 kN/m ²	2.1 kN/m ²	A = 2 kN/m ²
Roof floor	2 kN/m ²	0.8 kN/m ²	Snow = 1.2 kN/m ²
Stairwell	2.6 kN/m ²	2.2 kN/m ²	Stairs = 4 kN/m ²

Table 91 – Load patterns of the external walls

External walls		
Masonry – 30 cm		
Self-weight	Dead load	Live load
–	8 kN/m	–

Definition of the mass source and seismic load combinations

The definition of combination of loads and masses to be used for seismic analysis is based on the NTC 2018 [138] and in accordance to the Eurocodes [12, 136]. (5.15) represents the equation for the definition of the masses.

$$G_1 + G_2 + \sum_j \psi_{2j} Q_{kj} = G_1 + G_2 + 0,3Q_A + 0,6Q_C + 0,0Q_H \quad (5.15)$$

- G_1 - self weight
- G_2 - dead load
- Q_A - live load, areas for domestic and residential activities
- Q_C - live load, areas where people may congregate
- Q_H - live load, roof not accessible, except for normal maintenance and repair

The quasi-permanent (QP) load combination is used together with the seismic actions derived from the design response spectra (at the various limit states) for the dynamic linear analyses.

Following the definition of the model and masses, the natural vibration modes of the structure are determined with an eigenvalue analysis, dynamically characterising the response of the structure. By applying the design response spectrum to each vibration mode, the maximum values of stresses and displacements are then determined and finally combined using the principle of superposition of effects. As linear analyses, the energy dissipation during the earthquake is considered through the introduction of the

q-factor (behaviour factor) which leads to a reduction of the horizontal actions, resulting from the elastic response spectrum (design response spectrum). Three elastic response spectra are determined for the three performance levels defined as indicated in NTC2018 [138] and labelled in continuity with the performance levels defined by the Eurocode 8 – Part 3 [11].

- LS DL – Limit state of damage limitation; corresponding to SLD [138]
- LS SD – Limit state of significant damage; corresponding to SLV [138]
- LS NC – Limit state of near collapse; corresponding to SLC [138]

The q-factor is calculated from the results of the non-linear static analysis (pushover) and represents the progressive damage of the RC elements. Non-linear static analyses are carried out with reference to NTC2018 [138] and considering only one horizontal force distribution. A "uniform" pattern, with lateral forces proportional to the masses regardless of elevation was used for the pushover analyses. As shown in the results of the modal analyses, the strong torsional behaviour resulted in unreliable results from pushover analyses and particularly not conservative results for those analyses performed with distribution of forces proportional to vibration mode. Therefore, the following analyses have been performed.

- ULS: Ultimate limit states
- SLS: Serviceability limit states
- QP: Quasi-permanent vertical load combination
- LS DL [+QP]: DL Response Spectrum modal analysis in combination with QP
- LS SD [+QP]: SD Response Spectrum modal analysis in combination with QP
- GRAV: non-linear static vertical loads
- PUSH_X: non-linear static horizontal loads – uniform pattern acting along the longitudinal direction
- PUSH_Y: non-linear static horizontal loads – uniform pattern acting along the transverse direction

Restraints/Constraints

Fixed joints (6 DOF external restraints) were introduced at the foundation level.

The second, third, and attic floors present at least 4 cm of RC slabs that allow to consider rigid diaphragms. Therefore, constraints were defined and applied to all the joints belonging to these floor levels. The remaining floors (first floor of the main building and roof) present semi-rigid constraints and are modelled with membrane elements to replicate the stiffness of the floor in the direction of the joists.

Response spectrum functions and q-factors

Three reference elastic spectra, corresponding to the three main limit states, are defined to calculate the seismic demand for the non-linear analyses (Figure 142) and to perform the linear dynamic analyses. The definition of the acceleration value is based on [138, 150], using the data given in Table 92. The soil type is taken from the structural reports and has been classified as C. The building is classified with an importance class II.

Table 92 – Seismic parameters for the definition of the elastic response spectra – Source: [138, 150]

Spectrum type 1 – Ground type C – Seismic Zone III, OPCM 3519/06 [150]	$\gamma_I = 1.0$		
LS DL – $P_{VR} = 63\%$; $T_R = 50$ years; $V_R = 50$ years	$a_{gR} = 0.054g$	$F_0 = 2.398$	$T_c^* = 0.310$
LS SD – $P_{VR} = 10\%$; $T_R = 475$ years; $V_R = 50$ years	$a_{gR} = 0.149g$	$F_0 = 2.398$	$T_c^* = 0.310$
LS NC – $P_{VR} = 5\%$; $T_R = 975$ years; $V_R = 50$ years	$a_{gR} = 0.198g$	$F_0 = 2.398$	$T_c^* = 0.310$

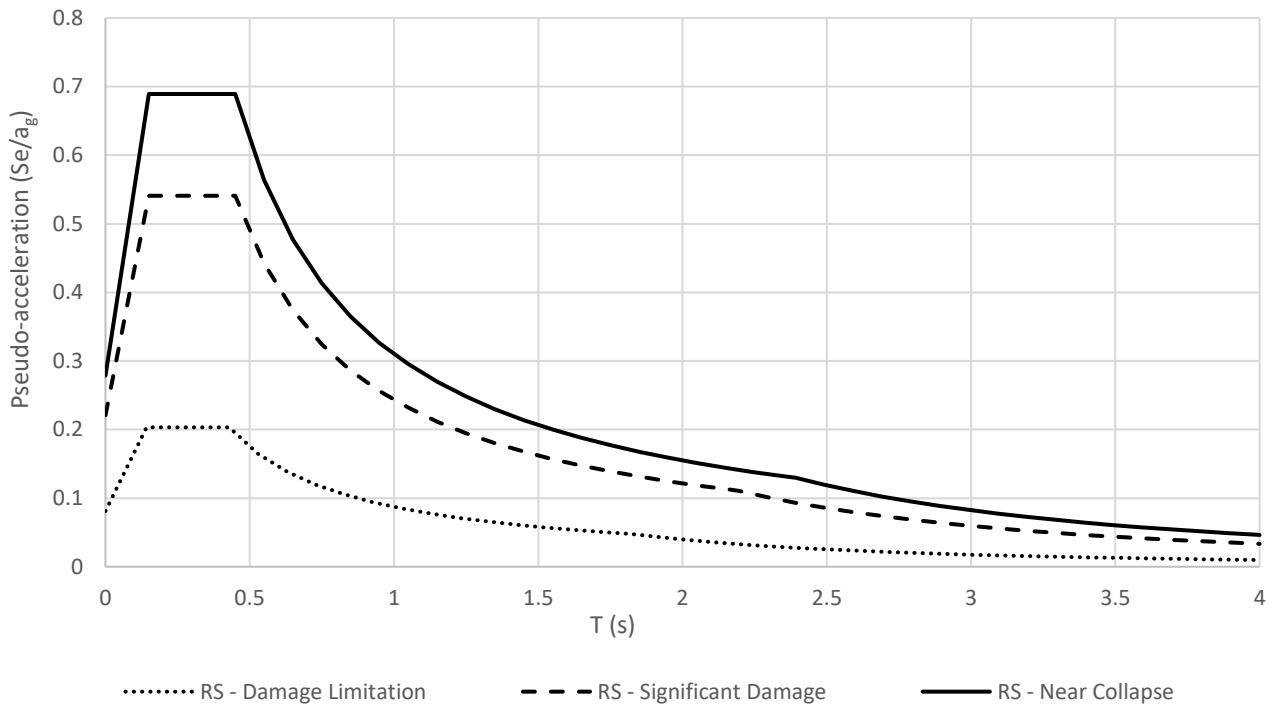

Figure 142 – Horizontal elastic response spectra for the three performance levels considered

For linear dynamic analyses, the design response spectrum for LS SD is calculated by dividing the ordinates of the elastic response spectrum by the q-factor. The latter depends to the regularity of the structure and on the ratio between the maximum horizontal force supported by the structure and the horizontal force corresponding to the formation of the first plastic hinge (first hinge reaching the elastic limit) as indicated by the Italian national standards (5.16) and (5.17) [137, 138]. The q-values have been conservatively calculated, considering the existing building with a load-bearing structure made of artificial bricks with hole percentages >15% instead of RC moment resisting frames. Using the minimum overstrength ratio (α_u/α_1) obtained from the pushover analyses performed in the same directions, two separate q-factors are given for the two main directions, which means two different design response spectra are applied. Regarding the verifications of brittle mechanisms, these were carried out with a q-factor of 1.5, as indicated in the Italian national standards cited above in accordance with the Eurocodes [11].

$$q = q_0 \cdot K_r \tag{5.16}$$

with

$$q_0 = 1.75 \frac{\alpha_u}{\alpha_1} \tag{5.17}$$

- α_u - maximum horizontal action value supported by the structure before collapse
- α_1 - horizontal action value corresponding to the formation of the first hinge
- K_r - coefficient for considering the structural regularity, in this case equal to 0.8

Table 93 – q-factor values for the initial state

LS Significant Damage	q – Initial state
Pushover analyses in longitudinal direction (X)	1.58
Pushover analyses in transverse direction (Y)	1.70
Verification for brittle failures	1.50

Plastic hinges

In order to perform the static non-linear analysis, the non-linear behaviour of all resistant elements involved in the analyses was defined. RC beams and columns were modelled as nonlinear frame elements with lumped plasticity by defining plastic hinges at both ends of the elements. The hinge properties follow the formulas reported in the Annex A of the Eurocode 8-Part 3 [11] for ductile mechanisms, complying with the Italian national standards and identifying the performance levels for each step of the non-linear static analysis (5.4), (5.5) and (5.6) in Section 5.1.1.3. The behaviour of these hinges is depending on the cross-section of the element, the material properties, the longitudinal and transversal steel reinforcements, and the axial loads calculated with a QP-combination of vertical loads. SAP2000 [129] provides default-hinge properties, PMM (combined bending and axial loads) hinges for columns and M3 (only bending loads) hinges for beams were assigned. In particular for this case study, fibre non-linear hinges were inserted to the ends of the columns. They consider a discretisation of the sections by placing reinforcement and concrete surfaces in the corresponding position and assigning to each fibre the relative stress-strain relationship. During the steps of the non-linear analyses, the hinges record progressive losses of the section as a function of the non-linear behaviour of the materials. In order to take brittle failures on the same elements into account, force-controlled hinges were placed in the middle of each column and at the ends of each beam (V2 for beams and V2-V3 for columns). The shear strength, which is the maximum allowable force for these hinges, is calculated with reference to the Italian national standards [137, 138] with (5.18), (5.19) and (5.20).

Displacement controlled non-linear hinges, placed at the ends of existing beams and columns.

- M3 for beams – Bending failure condition
- Fiber P-M2-M3 for columns – Combined axial and bending failure condition (axial loads from QP)

Force controlled plastic hinges were placed in the ends of the beams and in the middle of each column.

- V2 for beams – Shear force failure
- V2-V3 for columns – Shear force failure

$$V_{Rd} = \min (V_{Rsd}; V_{Rcd}) \quad (5.18)$$

$$V_{Rsd} = 0.9 \cdot d \cdot \frac{A_{sw}}{s} \cdot f_{yd} \cdot (\cot \alpha + \cot \theta) \cdot \sin \alpha \quad (5.19)$$

$$V_{Rsd} = 0.9 \cdot d \cdot b_w \cdot \alpha_c \cdot f'_{cd} \cdot \frac{(\cot \alpha + \cot \theta)}{(1 + \cot^2 \theta)} \quad (5.20)$$

- f'_{cd} - reduced design compressive strength of concrete ($f'_{cd} = 0.5 \cdot f_{cd}$)
- A_{sw} - area of the confinement bars
- α - angle of inclination of the transverse bars with respect to the beam axis
- α_c - increased coefficient
- s - span between confinement bars
- d - useful height of the section
- b_w - minimum width of the section
- f_{yd} - design value of yield strength of steel

Regarding the masonry walls, the equivalent frame method generally provides spandrels and piers as deformable beams. Their intersections are modelled as fully rigid, and the possible mechanical non-linearity is concentrated in well-defined cross-sections within the elastic part [153]. The masonry piers were modelled as elastoplastic elements with final brittle failures, by introducing two rocking hinges at the end of the deformable parts and one shear hinge at mid-height, as indicated in [154]. A rigid-perfectly plastic behaviour with final brittle failure was assumed for all these plastic hinges (Figure 143). Based on indications from the

Italian national standards, the strengths in terms of ultimate moment M_u (in plane and out of plane) and shear V_u are defined by the equations (5.21), (5.22) and (5.23) respectively. The contribution of the spandrels was neglected due to the relatively small dimensions.

In plane moment strength:

$$M_{Rd,ip} = \left(l^2 \cdot t \cdot \frac{\sigma_0}{2} \right) \cdot \left(1 - \frac{\sigma_0}{0.85 \cdot f_d} \right) = M_u \quad (5.21)$$

Out of plane moment strength:

$$M_{Rd,oop} = \left(t^2 \cdot l \cdot \frac{\sigma_0}{2} \right) \cdot \left(1 - \frac{\sigma_0}{0.85 \cdot f_d} \right) = M_u \quad (5.22)$$

- f_d - design compressive strength of masonry
- $\sigma_0 = P/(l \cdot t)$ - average compressive stress linked to the total area of the cross-section
- t - thickness of the wall resisting shear
- l - length of the wall

Shear strength:

$$V_{Rd} = f_{vd} \cdot t \cdot l_c = V_u \quad (5.23)$$

- f_{vd} - design shear strength of masonry, as a function of the average of vertical stresses on the compressed part of the wall providing shear resistance
- t - thickness of the wall resisting the shear
- l_c - length of the compressed part of the wall, neglecting the part of the wall in tension

The deformation limits were chosen according to the Italian national standards for existing masonry buildings [138]. They correspond to a rotation of 0.006 for bending stresses and 0.004 for shear. The three limit states were considered for LS DL, SD and NC through a percentage of the ultimate displacement, $0.5 \theta_u$, $0.8 \theta_u$ and θ_u respectively.

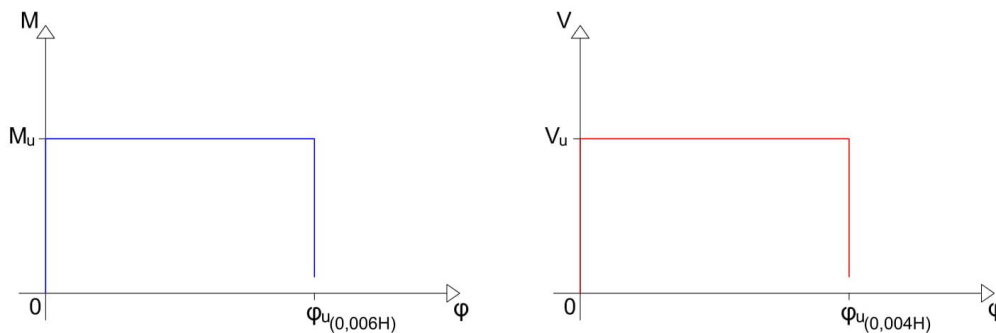

Figure 143 – Schematic graphs representing the definition of the plastic hinges for the masonry piers

5.2.1.4 Results

Modal analysis

The evaluation of the dynamic characteristics of the building is carried out by means of a modal analysis performed on the FEM. The analysis is carried out considering the first 12 vibration modes (modal masses greater than 5%) and checking that the total mass activated by the modes is greater than 85%. The following

are the results of the first four vibration modes (Table 94). The model providing shell elements as masonry walls has been used for this analysis.

Table 94 – Results of the modal analysis of the initial state

Mode	Period (s)	Initial State		
		U1	U2	RZ
1	0.518	61%	0	≈ 0
2	0.359	≈ 0	38.2%	29.2%
3	0.334	≈ 0	22.2%	14.9%
4	0.148	15.5%	0	≈ 0

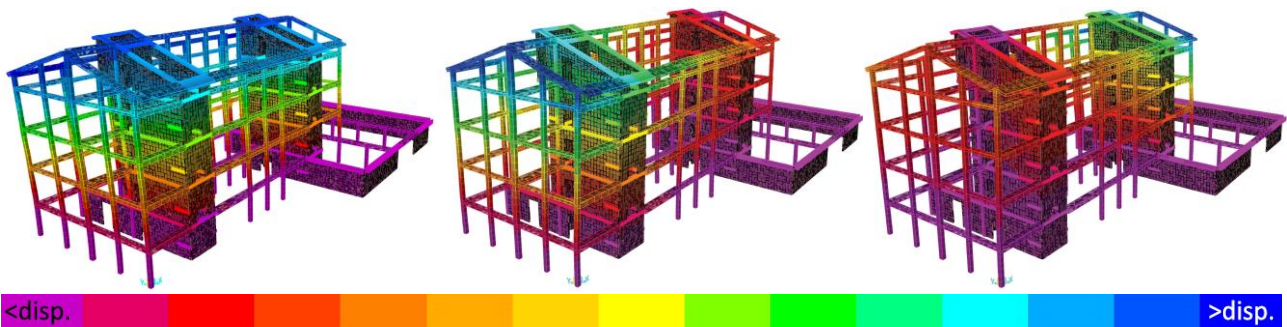

Figure 144 – Representation of the first three main vibration modes in ascending order from left to right; the displacements increase from purple to blue

As shown by the participating masses (Table 94) and the modal displacements (Figure 144) the dynamic behaviour of the structure is characterised by a significant torsional component, caused by the presence of the garage on the south-eastern side. The first mode is mainly in the longitudinal direction, due to the presence of short bearing walls. The second and third modes are in the transverse direction with small displacements, due to the long development of the rigid masonry walls. The north-west side presents high deformations, due to a reduced stiffness, compared to the other side where the garages structures affect the ground floor.

Linear dynamic analysis

Using the design response spectra, the maximum seismic action effects, associated with each vibration mode, were calculated and combined, directly from the software, using the complete quadratic combination (CQC). The response determined by two horizontal components with respect to the two main directions (X and Y) were combined by alternating the total contribution in one direction and 30% in the other direction, also permuting the signs of the contributions until the combinations were complete. In addition, an extra eccentricity of the mass centre was calculated at 5%, as indicated Italian national standards.

The displacements are a fundamental parameter to evaluate the behaviour of the structure during the earthquake, before and after the intervention, and allow a direct comparison between the initial and project state. In this case study, due to the presence of the masonry cores, the maximum and inter-storey displacements are not high at the LS DL and do not constitute a determining vulnerability. Table 95 shows the maximum top-displacements found at the DL LS for both main directions.

Table 95 – Maximum displacements of the linear dynamic analysis

Italian case study	Initial State	
LS DL	U1 (mm)	U2 (mm)
δ_{max} (Roof)	17.7	14.1

The vulnerability analysis was then carried out in terms of maximum stresses in the structural elements (force-based design). The design spectrum was progressively reduced until the verifications were satisfied, indicating a maximum percentage of seismic action supported by the structure $E(a_g)_{LS}$. The stresses of the structural elements were extrapolated by means of the finite element software and compared with the manually calculated resistances with reference to the Italian national standards [137, 138].

Through non-linear static analysis, the RC elements and masonry walls located the north-east side were identified as weak points of the existing structure. In particular masonry piers on that side were pointed out as critical points, limiting the displacement capacities of the building and also being characterised with brittle failures. For this reason, the linear dynamic analysis results were focused at checking the masonry piers of the lower levels of the northeast side of the structure. The stresses of the masonry piers were compared to the resistances calculated with the same formulas used for the definition of the plastic hinges, with the introduction of the γ_m coefficient to further reduce the resistances of the material. The only exception is the verification of shear for the masonry walls that was done using the following formula (5.24) [137].

$$V_t = l \cdot t \cdot \frac{1.5\tau_{0d}}{b} \sqrt{1 + \frac{\sigma_0}{1.5\tau_{0d}}} \quad (5.24)$$

- τ_{0d} , is the design value of the shear strength of masonry
- t , is the thickness of the wall resisting the shear
- l , is the length of the wall
- b , is a coefficient related to the distribution of the strain on the section, it depends on the slenderness of the pier

Proceeding with the verifications at the LS SD, the collapse was reached for the initial state in a percentage of seismic action comprised between 25-30%.

$$25\% \leq E(a_g)_{LS SD} \leq 30\%$$

Non-linear static analysis (pushover)

The non-linear static analyses were carried out with reference to the Italian national standards [138], but considering only one distribution of horizontal forces, more precisely, the uniform distribution with lateral forces proportional to masses. Further simplifications led to the execution of only two load combinations out of the sixteen foreseen for each force distribution. Therefore, only two pushover analyses were performed to investigate the behaviour of the structure in the two main directions. It is important to underline that the first vibration mode can be considered in line with the requirement for the application of a pushover analysis, having more than 60% of the mass activated in the longitudinal direction, while along transverse direction the second and the third modes do not activate enough mass due to a torsional behaviour, caused by the presence of the garages at the ground floor. For this reason, the results from the pushover analyses performed in transverse direction may be too conservative, especially with the modal force distribution, which is not reported here.

With reference to the results of the modal analyses, consistent results can be obtained along the longitudinal direction (X-U1). Regarding the transversal direction (Y-U2), results are reported where a percentage of participating mass equal to that activated by the first mode was assumed, in order to have consistent proportional results (less conservative). Further analysis should be provided on this case study, taking into account all the combinations required by the standards and exploiting adapting pushover analysis to examine the torsional components in transverse direction.

Based on these considerations, the capacity curves of the structure were obtained for the MDOF model (Section 5.2.3.6), and resulting in several reference parameters:

- using the target displacement verification (TDV) method (Annex B of [12]), the displacement capacities were evaluated and compared to the demands (D/C);
- the stiffness values at 70% (K_{70}) of the maximum seismic action are obtained in relation to the corresponding displacement, representing the slope of the initial part (linear behaviour) of the elastic perfectly plastic related system as expressed in (5.25);

$$K_{70} = \frac{0.7F_u}{d_{(0.7F_u)}} \quad (5.25)$$

- the reference peak ground acceleration (PGA) for the considered structure is reported. The acceleration value reported is the maximum capacity of the structure, obtained from the ratio between the total horizontal force capacity of the structure (calculated with respect to the limit state defined by the standards) and the mass activated along that direction by the vibration mode. In order to obtain the value referred to the ground, it was necessary to consider S and F_0 , which indicate respectively the subsoil category coefficient and the amplification factor [138].

$$a_g \cdot S = \frac{V_{max,LS}}{m^* \cdot g} \quad (5.26)$$

$$PGA_{C,LS} = \frac{(a_g \cdot S)_{LS}}{F_0} \quad - \text{ if } T_B \leq T < T_C \quad (5.27)$$

$$PGA_{C,LS} = \frac{(a_g \cdot S)_{LS}}{F_0} \cdot \frac{T}{T_C} \quad - \text{ if } T_C \leq T < T_D \quad (5.28)$$

$$PGA_{D,LS} = \frac{S_e(T)}{F_0} \quad - \text{ if } T_B \leq T < T_C \quad (5.29)$$

$$PGA_{D,LS} = \frac{S_e(T)}{F_0} \cdot \frac{T}{T_C} \quad - \text{ if } T_C \leq T < T_D \quad (5.30)$$

With

- $V_{max,LS}$ - maximum horizontal force for which at least one plastic hinge reaches the LS;
- m^* - participating mass of the vibration mode acting in the same direction of the forces;
- PGA_D - acceleration demand from the elastic response spectrum;
- PGA_C - acceleration capacity associated with the exceedance of the LS limit by a plastic hinge;
- F_0 - amplification factor;
- S - subsoil category coefficient;
- T - period of the structure;
- $S_e(T)$ - pseudo-acceleration obtained from the elastic response spectrum as function of the period.

The main results of the initial state for the Italian case study are presented below.

Initial state, Italian case study (uniform force distribution – X)

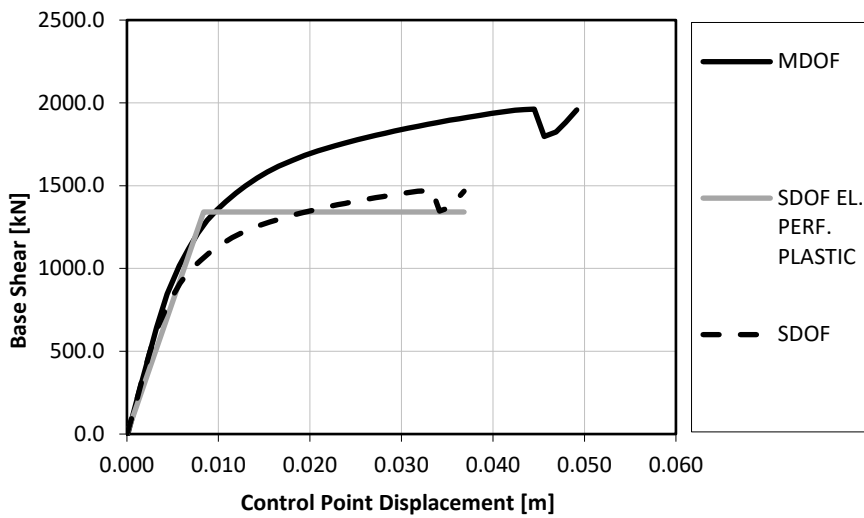

SDOF parameters.

$$\Gamma = 1.334$$

$$m^* = 846.6 \text{ kN s}^2/\text{m}$$

$$k^* = 159'968 \text{ kN/m}$$

$$T^* = 0.567 \text{ s}$$

$$F_y^* = 1'341 \text{ kN}$$

$$d_y^* = 0.0084 \text{ m}$$

$$d_u^* = 0.0368 \text{ m}$$

Figure 145 – Representation of the capacity curves for both MDOF and SDOF systems and relative bi-linearisation of the SDOF curve with the use of the parameters reported on the right; uniform force distribution along X-direction

Table 96 – Pushover analysis results; uniform force distribution along X-direction

Assessment results – LS Damage Limitation	
Displacement demand (D)	13.33 mm
Displacement capacity (C)	22.75 mm
D/C Ratio	58.6%
K_{70}	103'796 kN/m
Total shear capacity - V_{max}	1'741 kN
PGA_D	0.074 g
PGA_C	0.080 g
C/D Ratio	100%
Assessment results – LS Significant Damage	
Displacement demand (D)	36.96 mm
Displacement capacity (C)	30.75 mm
D/C Ratio	120.2%
K_{70}	103'796 kN/m
Total shear capacity - V_{max}	1'848 kN
PGA_D	0.221 g
PGA_C	0.091 g
C/D Ratio	41%
Assessment results – LS Near Collapse	
Displacement demand (D)	58.32 mm
Displacement capacity (C)	30.75 mm
D/C Ratio	189.7%
K_{70}	103'796 kN/m
Total shear capacity - V_{max}	1'848 kN
PGA_D	0.278 g
PGA_C	0.091 g
C/D Ratio	33%

Initial state, Italian case study (uniform force distribution – Y)

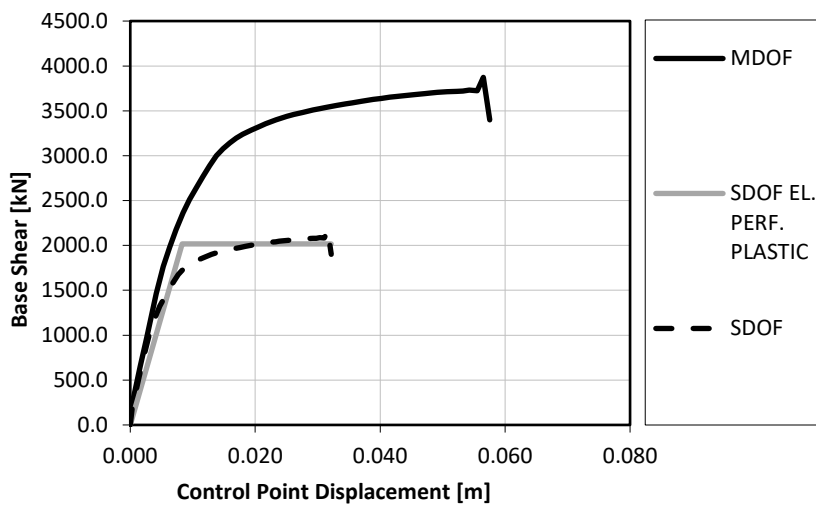

SDOF parameters.

$$\Gamma = 1.789$$

$$m^* = 393.7 \text{ kN s}^2/\text{m}$$

$$k^* = 242'612 \text{ kN/m}$$

$$T^* = 0.253 \text{ s}$$

$$F_y^* = 2'017 \text{ kN}$$

$$d_y^* = 0.008 \text{ m}$$

$$d_u^* = 0.032 \text{ m}$$

Figure 146 – Representation of the capacity curves for both MDOF and SDOF systems and relative bi-linearisation of the SDOF curve with the use of the parameters reported on the right; uniform force distribution along Y-direction

Table 97 – Pushover analysis results; uniform force distribution along Y-direction

Assessment results – LS Damage Limitation	
Displacement demand (D)	5.79 mm
Displacement capacity (C)	14.89 mm
D/C Ratio	38.9%
K_{70}	242'612 kN/m
Total shear capacity - V_{max}	3'079 kN
PGA_D	0.081 g
PGA_C	0.178 g
C/D Ratio	100%
Assessment results – LS Significant Damage	
Displacement demand (D)	15.66 mm
Displacement capacity (C)	38.91 mm
D/C Ratio	40.3%
K_{70}	242'612 kN/m
Total shear capacity - V_{max}	3'627 kN
PGA_D	0.221 g
PGA_C	0.214 g
C/D Ratio	97%
Assessment results – LS Near collapse	
Displacement demand (D)	23.32 mm
Displacement capacity (C)	47.13 mm
D/C Ratio	47.13%
K_{70}	242'612 kN/m
Total shear capacity - V_{max}	3'693 kN
PGA_D	0.278 g
PGA_C	0.216 g
C/D Ratio	78%

5.2.2 Project state, application of the steel exoskeleton

The external structure foreseen in the project solution consists of a steel frame (two columns and a beam) for each floor, with bracing in the transverse direction, connected to the existing RC frame at the column-beam joints. These rigid frames, acting as shear walls, increase the stiffness of the existing RC frames towards the seismic action acting in plane of the frames. The connection of these external frames in longitudinal direction creates additional space at each level of the existing structure.

This building was analysed as a first feasibility study of the exoskeleton on which the use of structural aluminium compared to the steel solution was tested. The results are reported to enrich the work carried out and to present a further application of the exoskeleton in a different territorial and typological context. However, several possible improvements, studied for the Athens case, have not been investigated here due to time constraints.

Possible implementations that have been shown to improve the strategy, not implemented here, are:

- the use of hinged connections;
- the distribution of stiffnesses in the exoskeleton to avoid pre-existing torsional components;
- the use of lower steel grades for the diagonal bracing;
- the use of non-linear dynamic analyses;
- the provision of a detailed solution based on the singularities of the existing building.

5.2.2.1 Materials

S275 grade steel was used for all the structural elements constituting the exoskeleton. Table 98 shows the mechanical parameters of the steel grade used in the model.

Table 98 - Mechanical parameters of the steel grades provided in the new external structures – Source: [131]

Steel Grade	$f_{yk}(MPa)$	$f_{tk}(MPa)$	$f_{yd}(MPa) = \frac{f_{yk}}{\gamma_s}$	$f_{td}(MPa) = \frac{f_{tk}}{\gamma_s}$	$E(MPa)$	$G(MPa)$	ν
S275 (t≤40 mm)	275	430	261.9	409.5	210'000	80'000	0.3

5.2.2.2 Structural schemes and characterisation of the members

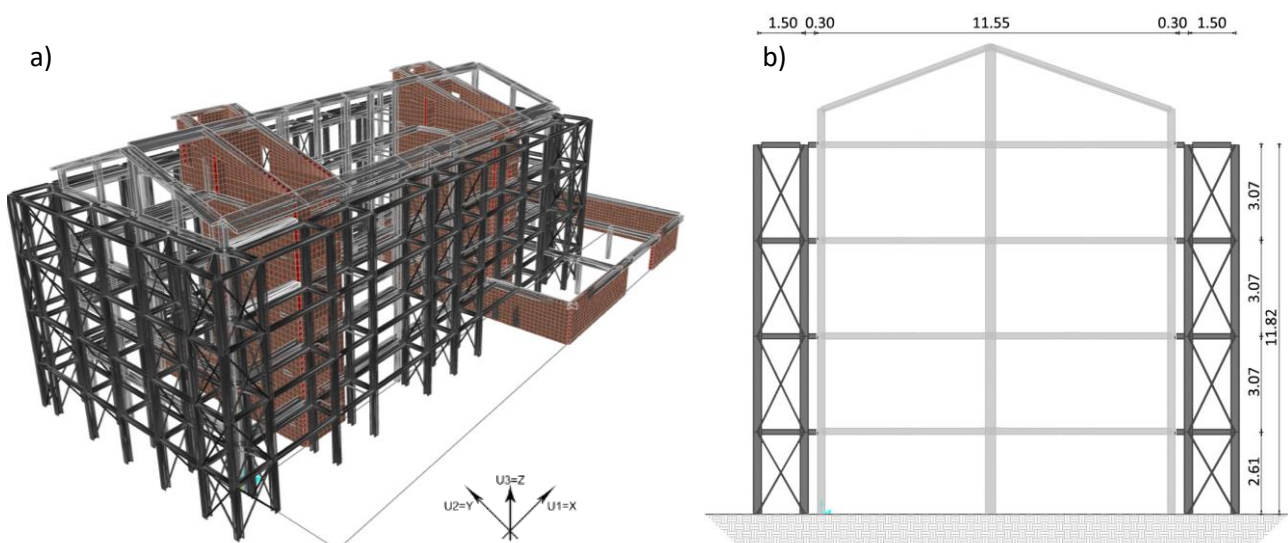

Figure 147 – a) Panoramic view of the finite element model of the application of the exoskeleton on the Italian case study; b) elevation scheme of the exoskeleton in the middle RC frame (m as units)

The connection is realised as the rigid link (RL) introduced in the previous chapter and provides a rigid connection between the two structures by means of a steel profile connected on both structures. HEA profiles (Table 99) were chosen to guarantee the collaboration between the two structures in both directions and modelled, using a frame element between the two structures.

5.2.2.3 Modelling parameters

Load patterns

As presented in Chapter 7, the architectural units are divided into three types: balcony, sun space and extra room. The intention of the project is to allow users the freedom to customise their living space by choosing between these types, according to their economic availability or simply aesthetics. Consequently, in the structural analysis, it was decided to apply the greatest load, characteristic of the extra-room on all the spans of the exoskeleton. The following tables show the loads considered on the external strengthening structure, based on the architectural components provided at the time of the analyses (Tables 100 and 101).

The categories selected for imposed and snow loads refer to the Italian national standards [138]. The balcony live load has been used for all the external units as the most conservative. Therefore, surface loads were applied on the new areas within the exoskeleton (supported by the IPE beams).

Table 100 – Load patterns assigned to the floors of the extensions – Source: [138]

Floors			
CLT floors			
	Self-weight	Dead load	Live load
n floor	0.625 kN/m^2	0.76 kN/m^2	Balcony = 4 kN/m^2
Roof floor	0.625 kN/m^2	0.76 kN/m^2	Snow = 1.20 kN/m^2

The external partitions were included as additional linear load to be applied on the external beams.

Table 101 – External walls load patterns

Extra rooms partitions		
Self-weight	Dead load	Live load
–	2.07 kN/m	–

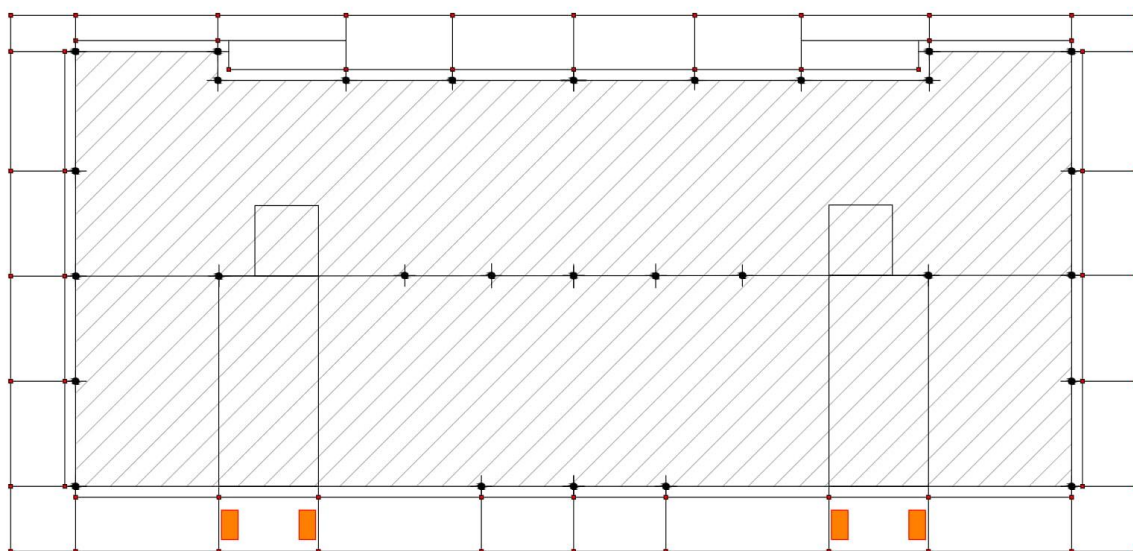

Figure 149 – Positioning of the ELFOpack system on the new addition

Finally, the loads due to the most impactful system components were included. The integrated system involves the installation of a single machine for air conditioning of the entire flat. The machine has a considerable weight of 400 kg due to the presence of a water tank. This additional load was placed in the steel extension as shown in Figure 149, considering four machines for each floor (one per apartment).

Constraints/Restrains

Given the concept of floor prefabrication characterised by a rapid assembly phase, as a precautionary measure no diaphragm constraints were applied to the joints belonging to the steel exoskeleton.

In addition, in line with the choice for the initial state assessment, the foundations were not modelled, and restraints were provided, fixing all six degrees of freedom.

Response spectrum functions and q-factors

The horizontal elastic response spectra are the same as those considered in the previous section. The design response spectra considered in the linear dynamic analyses depends on the behaviour factor q . The nonlinear analyses carried out in parallel allowed the exploitation of the exoskeleton to be verified and the behaviour factor (q) for the linear analyses can be increased considering the plasticisation of the new steel structure. The increase of the overstrength ratios allowed to consider higher q -factors from the capacity curves obtained with the non-linear static analysis. Table 102 shows the minimum values calculated and used in the analyses.

Table 102 – q-factor values for the project state

LS Significant Damage	q – Initial state	q – Project state (RL)
Pushover analyses in longitudinal direction (X)	1.58	2.43
Pushover analyses in transverse direction (Y)	1.70	2.65
Verification for brittle failures	1.50	1.50

The increase in capacity and stiffness is linked to a reduction in displacements, which leads to an increase in both the numerator and the denominator for the calculation of the global overstrength factor. The application of the exoskeleton makes it possible, through higher overstrength factors, to increase the q -factors in both directions: in longitudinal direction (X) from 1.58 to 2.43, and from 1.70 to 2.65 in the transverse direction (Y).

However, the brittle behaviour of masonry walls limits the possibility of the exoskeleton since premature failures in these elements do not allow an efficient exploitation of the external structure.

Plastic hinges

In order to perform the static non-linear analysis, the non-linear behaviour of all resistant elements of the exoskeleton was defined. Beams and columns were modelled as nonlinear frame elements with lumped plasticity by defining plastic hinges at both ends of the elements. The hinge properties for steel members are based on Table 5-6 of FEMA-356 [146] and are in accordance with the values given in Annex B of Eurocode 8-Part 3 [11] for ductile mechanisms. They can identify the performance levels for each step of the non-linear static analysis.

In the same way, plastic hinges for bracing were provided with reference to Table 5-7 of FEMA-356 [146], complying with Tables B.2 and B.3 of Eurocode 8 – Part 3 [11] and automatically inserted in the middle of every diagonal bracing. Displacement controlled non-linear hinges, placed at the ends of steel beams and columns and in the middle of the diagonal bracing are the following.

- M3 for beams – Bending failure condition

- P-M2-M3 for columns – Combined axial and bending failure condition (axial loads from QP)
- P for diagonal bracing – Axial failure condition

5.2.2.4 Results

Modal analysis

The following are the results of the first four vibration modes related to the four cases with the application of the steel exoskeleton (Table 103 and Figure 150).

Table 103 – Results of the modal analysis of the project solution; periods are expressed in seconds while participating masses are percentages of the total mass of the building

Italian case study – Project Solution				
Mode	Period (s)	Participation Mass		
		U1	U2	RZ
1	0.442	63.6%	0	0
2	0.322	≈ 0	29.4%	38.8%
3	0.301	≈ 0	35%	11.1%
4	0.168	0.25%	0	≈ 0

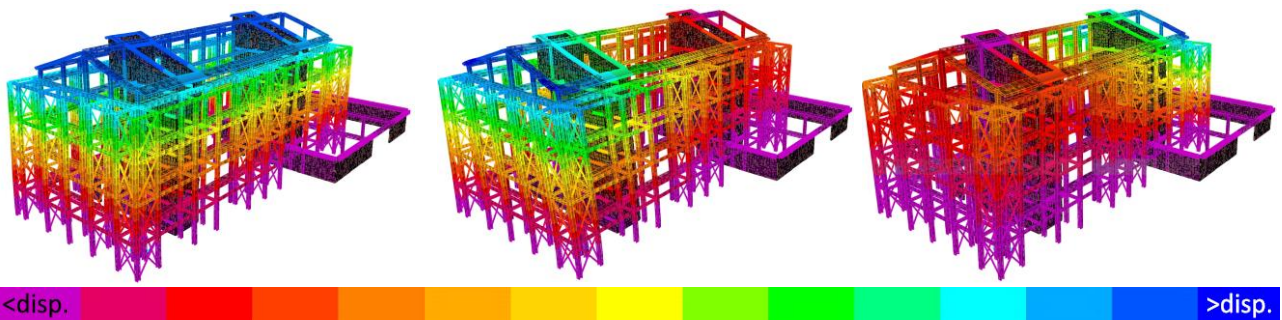

Figure 150 – Representation of the first three main vibration modes in ascending order from left to right for the project solution; the displacements increase from purple to blue

As mentioned above, a customised stiffness distribution based on the dynamic behaviour of the existing structure would have made it possible to avoid torsional phenomena still present here due to the application of a symmetrical exoskeleton.

Linear dynamic analysis

The values of the maximum displacements of the same joints of the previous paragraph are shown in table 104. In addition, the relative percentages of variations at the LS DL are reported.

Table 104 – Maximum displacements calculated with the linear dynamic analysis for both main directions (X and Y) for the project solutions with hinged (HL) and rigid connections (RL)

Italian case study	Project solution	
LS DL	U1 (mm)	U2 (mm)
δ_{max} (Roof)	15.0	9.8
-Δ-	15.3%	30.5%

It can be seen that in terms of maximum top-displacements the reduction is around 30% in transverse direction is around 30% and 15% in longitudinal direction.

The vulnerability analysis was then carried out in terms of maximum stresses in the structural elements as described in Section 5.2.1.4. The vulnerability assessment carried out with dynamic linear analysis (force-based design) for LS SD was found to be satisfied with higher percentages of the design seismic loads.

$$65\% \leq E(a_g)_{LS SD} \leq 70\%$$

The dynamic linear analysis allows us to consider the effects of the torsional behaviour in the elements and therefore must be carried out in complicity with the non-linear static analysis. This allows to evaluate the increase of seismic capacity supported by the structure as it manages to include a deformation capacity (even if low) of the masonry piers. On the contrary, force-based design methods, such as linear dynamic analyses, are based on checks on maximum strength values which result more conservative, reaching lower values of seismic forces.

Verifications of the exoskeleton

The verifications on the structural members of the exoskeleton were carried out with the design software. The strength and deformability checks were carried out considering the ultimate limit states (LS SD and ULS) and the operational limits (LS DL and SLS) respectively. The software complies with the Italian national standards required for the verification of the steel members [137, 138]. For a complete overview of the procedures provided by the software, reference is made to the software design manuals (SAP2000 [129]).

Non-linear static analysis (pushover)

As reported above, the results of the modal analysis show that the first vibration mode can be considered in line with the requirement for the application of a pushover analysis, having more than 60% of the mass activated in the longitudinal direction, while along transverse direction the second and the third modes do not activate enough mass due to a torsional behaviour caused by the presence of the garages at the ground floor, as happened for the initial state. For this reason, the results from the pushover analyses performed in transverse direction may be too conservative, especially with the modal force distribution, which is not reported here. This translates in consistent results along the longitudinal direction (X-U1), while for the transversal direction (Y-U2) the results are reported modifying the percentage of participating mass, imposing it equal to that activated by the first longitudinal mode to have consistent proportional results (less conservative).

Further analysis should be provided considering all the combinations required by the standards and exploiting adapting pushover analysis to consider the torsional components in transverse direction.

Once the analyses have been carried out for the design solution the reference parameters described in Section 5.2.1.4 have been reported.

Project state, Italian case study (uniform force distribution – X)

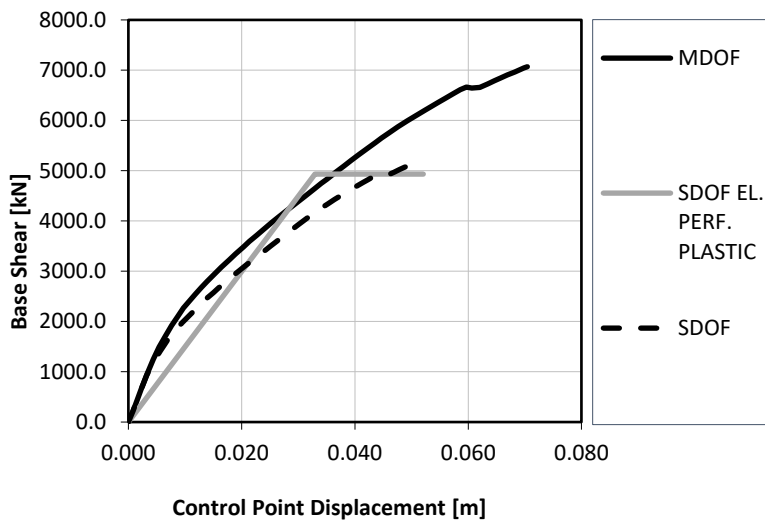

SDOF parameters.

$$\Gamma = 1.353$$

$$m^* = 999 \text{ kNs}^2/\text{m}$$

$$k^* = 149'661 \text{ kN/m}$$

$$T^* = 0.513 \text{ s}$$

$$F_y^* = 4'933 \text{ kN}$$

$$d_y^* = 0.033 \text{ m}$$

$$d_u^* = 0.052 \text{ m}$$

Figure 151 – Representation of the capacity curves for both MDOF and SDOF systems and relative bilinearisation of the SDOF curve with the use of the parameters reported on the right; uniform force distribution along X-direction

Table 105 – Pushover analysis results; uniform force distribution along X-direction

Assessment results – LS Damage Limitation	
Displacement demand (D)	15.14 mm
Displacement capacity (C)	26.49 mm
D/C Ratio	57.1%
K_{70}	149'661 kN/m
Total shear capacity - V_{max}	4'076 kN
PGA_D	0.081 g
PGA_C	0.166 g
C/D Ratio	100%
Assessment results – LS Significant Damage	
Displacement demand (D)	42.36 mm
Displacement capacity (C)	38.03 mm
D/C Ratio	111.4%
K_{70}	149'661 kN/m
Total shear capacity - V_{max}	5'090 kN
PGA_D	0.221 g
PGA_C	0.212 g
C/D Ratio	96%
Assessment results – LS Near Collapse	
Displacement demand (D)	53.98 mm
Displacement capacity (C)	44.72 mm
D/C Ratio	120.7%
K_{70}	149'661 kN/m
Total shear capacity - V_{max}	5'652 kN
PGA_D	0.278 g
PGA_C	0.233 g
C/D Ratio	84%

Project state, Italian case study (uniform force distribution – Y)

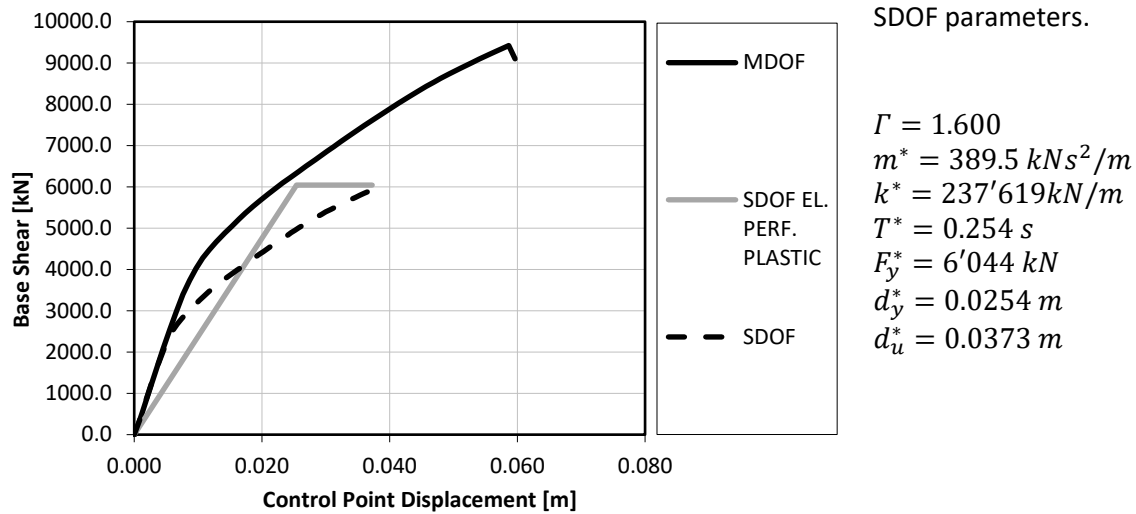

Figure 152 – Representation of the capacity curves for both MDOF and SDOF systems and relative bilinearisation of the SDOF curve with the use of the parameters reported on the right; uniform force distribution along Y-direction

Table 106 – Pushover analysis results; uniform force distribution along Y-direction

Assessment results – LS Damage Limitation	
Displacement demand (D)	5.231 mm
Displacement capacity (C)	6.549 mm
D/C Ratio	79.9%
K_{70}	237'619 kN/m
Total shear capacity - V_{max}	2'969 kN
PGA_D	0.081 g
PGA_C	0.194 g
C/D Ratio	100%
Assessment results – LS Significant Damage	
Displacement demand (D)	13.92 mm
Displacement capacity (C)	31.28 mm
D/C Ratio	44.5%
K_{70}	237'619 kN/m
Total shear capacity - V_{max}	6'979 kN
PGA_D	0.221 g
PGA_C	0.466 g
C/D Ratio	100%
Assessment results – LS Near collapse	
Displacement demand (D)	17.74 mm
Displacement capacity (C)	34.94 mm
D/C Ratio	34.94%
K_{70}	237'619 kN/m
Total shear capacity - V_{max}	7'368 kN
PGA_D	0.278 g
PGA_C	0.487 g
C/D Ratio	100%

In order to evaluate the strengthening intervention by means of external steel shear walls applied perpendicularly to the existing façades, the set of parameters introduced in Section 5.2.2.4 was compared before and after the application of the exoskeleton.

- The demand/capacity ratios (D/C) for the TDV must remain below 100%. For the initial state, the results indicated seismic vulnerability in the longitudinal direction and rigid behaviour in the transverse direction. The masonry walls are decisive for the response of the structure and stiff along their main plan in transverse direction, providing sufficient capacity and limiting displacement capacity in the longitudinal direction where short bearing walls with openings represent weak points. Along this direction the D/C in terms of TDV is about 120% and 190% for the LS SD and NC respectively. After application of the exoskeleton, these ratios were reduced to 111% and 121%. The TDVs in transverse direction indicate that no strengthening was required (non-conservative results).
- The stiffness was increased from 103'796 kN/m to 149'661 kN/m (Δ_{increase} of 1.44) in the longitudinal direction, while it remained constant in transverse direction where the presence of the long masonry walls remains predominant.
- The C/D ratios in term of peak ground acceleration (PGA) record the increase in strength directly related to the entity of the lateral forces, taking into account the increase in demand due to the reduction of the natural periods on the elastic response spectra. The exoskeleton made it possible to increase the collapse acceleration for all the performance levels analysed. With reference to the LS SD, it can be noted that with the application of the external exoskeleton, there is an increase in the PGA from 41% to 96% of the design seismic action along the longitudinal direction and from 97% to 100% in the transverse direction. With difference to the linear dynamic analysis, torsional components are not fully considered in this evaluation, which is non-conservative, especially for the transverse direction.

Exploitation of the exoskeleton

With the aim of assessing the exploitation of the exoskeleton, the part of horizontal force taken by the exoskeleton is extrapolated and compared with the total action. The values are derived from pushover analyses with uniform force distribution (as the worst case) and in relation to the limit states defined by the standards (Table 107).

Table 107 – Exploitation of the exoskeleton in terms of horizontal forces; calculated at the steps of the pushover analysis corresponding to the interested LS with modal force distribution for the project solution

Italian case study – Project state, steel exoskeleton				
PUSH-X Mass	Total Shear (kN)	Existing Structure (kN)	Steel Exoskeleton (kN)	Exploitation (%)
LS DL	4'076	3'179	897	22%
LS SD	5'090	3'563	1'527	30%
LS NC	5'652	3'787	1'865	33%
PUSH-Y Mass	Total Shear (kN)	Existing Structure (kN)	Steel Exoskeleton (kN)	Exploitation (%)
LS DL	2'969	2'583	386	13%
LS SD	6'979	5'234	1'745	25%
LS NC	7'368	5'379	1'989	27%

As can be seen from these results, the exploitation of the exoskeleton is around 25-30% in both directions. These values allow to determine the percentage of collaboration between existing and new structures. The response is influenced in both sides by the masonry walls. While in the transverse direction the long walls imply a rigid behaviour that does not allow the exoskeleton to take horizontal forces, in longitudinal direction, the short displacement capacity of the masonry elements implies collapses at small displacements.

5.2.3 Project state, application of the aluminium exoskeleton

As introduced in Section 4.4, this investigation was done in collaboration with ALIVA Srl, partner of Pro-GET-onE, which provided the know-how for the conception of a similar exoskeleton, hypothesis on materials, joints, cross-section of profiles, and construction procedures. The same analyses carried out with the steel structure are performed with an exoskeleton, composed by extruded aluminium sections and eventually compared.

5.2.3.1 Materials

The 6082 T6 aluminium alloy was used for all the structural elements constituting the exoskeleton, with the sole exception of the diagonal bracing. 6060 T5 alloy was used for these profiles in order to respect the strength hierarchy for braced frame structures and to entrust the dissipative capacity to the diagonal element subjected to tensile stress. Table 108 shows the mechanical parameters of the aluminium alloys used in the model.

Table 108 – Mechanical parameters of the aluminium alloys provided in the new external structures – Source: [126]

Steel Class	$f_{yk}(MPa)$	$f_{tk}(MPa)$	$f_{yd}(MPa) = \frac{f_{yk}}{\gamma_s}$	$f_{td}(MPa) = \frac{f_{tk}}{\gamma_s}$	$E(MPa)$	$G(MPa)$	ν
Aluminium 6082 T6	260	310	236.36	281.82	69'000	26'000	0.3
Aluminium 6060 T5	100	140	90.91	127.27	69'000	26'000	0.3

5.2.3.2 Structural schemes and sections

The scheme of the structure used in the structural strengthening of the case study is shown below (Figures 153a, 153b and Table 109). It follows the scheme of the steel structure introduced in the previous section by changing sections and material with the corresponding profiles (Table 109).

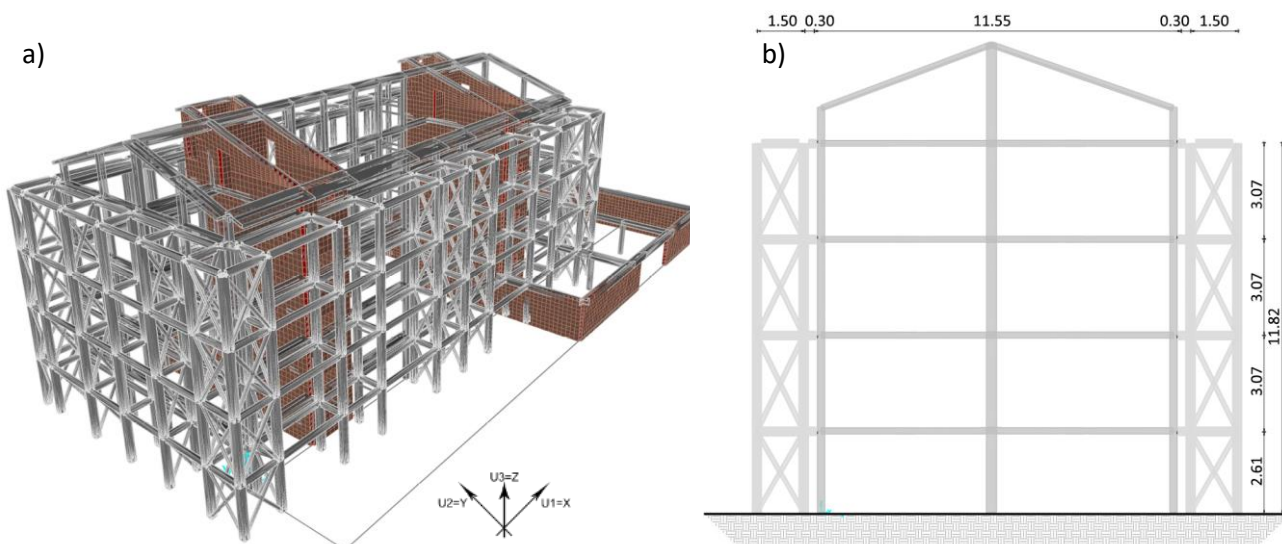

Figure 153 – a) Panoramic view of the finite element model of the application of the exoskeleton on the Italian case study; b) elevation scheme of the exoskeleton in the middle RC frame (m as units)

The exoskeleton is symmetrically applied around the perimeter of the existing structure, and therefore without considering a possible distribution of stiffness to improve the dynamic behaviour and assuming a

partial demolition of the garages. It was decided to investigate the application of the exoskeleton around the entire building to ensure the strengthening in both directions. Table 109 defines the cross-sections, followed by pictures and data for the four main profiles.

Table 109 – Aluminium corresponding profiles and related alloy

Structural element	Cross-section - Steel	Aluminium profile	Aluminium alloy
Columns	HEA280	Column A and B	6082 T6
Transverse Beams	HEA180	Rectangular beam A	6082 T6
Longitudinal Beams	IPE 220	Rectangular beam A	6082 T6
Bracing pipes	φ76.1x3.2	U diagonal profile	6060 T5
Connections profiles	HEA180	Rectangular beam A	6082 T6

Aluminium sections

Table 110 – Aluminium cross-sections provided by ALIVA Srl, with relative parameters

Column A	
	<p>Area: - 25'484 mm²</p> <p>Moment of inertia I33 (X): - 2.871 10⁸ mm⁴</p> <p>Moment of inertia I22 (Y): - 2.871 10⁸ mm⁴</p> <p>Shear area AS2 (Y): - 13'457 mm²</p> <p>Shear area AS3 (X): - 13'457 mm²</p> <p>Weight: - 68.81 kg/m</p>
Column B	
	<p>Area: - 14'924 mm²</p> <p>Moment of inertia I33 (X): - 1.635 10⁸ mm⁴</p> <p>Moment of inertia I22 (Y): - 1.635 10⁸ mm⁴</p> <p>Shear area AS2 (Y): - 7'480 mm²</p> <p>Shear area AS3 (X): - 7'480 mm²</p> <p>Weight: - 40.29 kg/m</p>

Rectangular beam A	
	<p>Area: - 9'250 mm²</p> <p>Moment of inertia I33 (X): - 9.455 10⁷ mm⁴</p> <p>Moment of inertia I22 (Y): - 2.281 10⁷ mm⁴</p> <p>Shear area AS2 (Y): - 6'160 mm²</p> <p>Shear area AS3 (X): - 3'750 mm²</p> <p>Weight: - 25.53 kg/m</p>
U diagonal profile	
	<p>Area: - 2'112 mm²</p> <p>Moment of inertia I33 (X): - 6.156 10⁶ mm⁴</p> <p>Moment of inertia I22 (Y): - 9.682 10⁵ mm⁴</p> <p>Shear area AS2 (Y): - 1'120 mm²</p> <p>Shear area AS3 (X): - 1'120 mm²</p> <p>Weight: - 5.702 kg/m</p>

Through the extrusion from matrixes, it is possible to provide customised profiles with several stiffening plates, depending on the design needs and guaranteeing a considerable stiffness with relatively lighter profiles.

5.2.3.3 Modelling parameters

Response spectrum functions and q-factors

The horizontal elastic response spectra are the same as those considered in the previous section. The design response spectra considered in the linear dynamic analyses depends on the behaviour factor q. The non-linear analyses carried out in parallel allowed the verification of the exploitation of the exoskeleton and the increase of the behaviour factor q for the linear analyses, considering the plasticisation of the new steel structure. The increase of the overstrength ratios allowed to consider higher q-factors from the capacity curves obtained with the non-linear static analysis; Table 111 shows the minimum values calculated and used in the analyses.

Table 111 – q-factor values for the project state

LS Significant Damage	q – Initial state	q – Project state (Steel)	q – Project state (Aluminium)
Pushover analyses in longitudinal direction (X)	1.58	2.43	2.69
Pushover analyses in transverse direction (Y)	1.70	2.65	2.49
Verification for brittle failures	1.50	1.50	1.50

The increase in capacity and stiffness is linked to a reduction in displacements, which leads to an increase in both the numerator and the denominator for the calculation of the overall overstrength factor. The application of the exoskeleton allows, through the increase of the overstrength factors, to raise the q-factors in both directions to values comparable to the steel solution. As with the steel solution, the brittle behaviour of the masonry walls governs the collapse of the existing structure, hampering the exploitation of the external structure one.

Plastic hinges

With regard to the aluminium behaviour of cross-sections beyond the elastic limit, reference is made to Annex F of the Eurocode 9 [126]. This annex provides specifications to estimate the post-elastic behaviour of cross-sections, based on the mechanical properties of the material and the geometrical characteristics of the section. Since no standards are defined for aluminium in seismic areas, reference is made to the limit states given in this annex. For each limit state, a final resistance value is defined which has been used in the creation of the plastic hinges of bracings and beams. In addition, each limit state is directly related to the class of the aluminium profile. The subdivision classes for aluminium are very strict compared to steel and determined according to specific dimensional ratios and the stress values to which they are subjected. The worst classification by element type was considered to determine the ultimate values assigned to plastic hinges (Table 112). For the tensile action of the diagonals, reference is made to CNR-DT 208/2011 [155].

Table 112 – Ultimate values for creation of the plastic hinges in braces and beams – Source: [126, 155]

Stress	Element	Limit State	Section class	Correction factor	Formula
N* – Axial load	Bracing	Plastic phase	Class 3	$\alpha_{N,3} = 1$	$N_{Rd} = \alpha_{N,3} \cdot A \cdot f_d$
N* – Axial load	Bracing	Collapse	Class 3	$\alpha_{N,3} = f_t/f_0$	$N_{Rd} = \alpha_{N,3} \cdot A \cdot f_d$
M3 – Bending moment	Beam	Elastic	Class 3	$\alpha_{N,3} = 1$	$M_{Rd} = \alpha_{M,3} \cdot W_{el} \cdot f_d$

Finally, for the aluminium columns, PMM plastic fibre hinges (combined bending and axial loads) were inserted at the ends of the elements. These hinges consider a discretisation of the sections into small fibres, characterised by a relative stress-strain relationship. During the steps of the non-linear analyses, the hinges record progressive losses of the section as a function of the non-linear behaviour of the material (aluminium alloy 6082 T6).

Displacement controlled non-linear hinges at the ends of existing columns.

- Fibre P-M2-M3 for columns – Combined axial and bending failure condition (axial loads from QP)

Force controlled plastic hinges were placed in the ends of the beams and in the middle of each bracing.

- M3 for beams – Bending failure condition
- P for diagonal bracing – Axial failure condition, characterised by a plastic limit (LS DL) and a subsequent collapse (LS NC)

5.2.3.4 Results

Modal analysis

The following are the results of the first four vibration modes related to the four cases with the application of the aluminium exoskeleton (Table 113). The aluminium solution was designed to be fully comparable to the steel exoskeleton in terms of structural response, (as shown in all the following results).

Table 113 – Modal analysis results

Italian case study – Project Solution				
Mode	Period (s)	Participation Mass		
		U1	U2	RZ
1	0.443	63.0%	0	0
2	0.322	≈ 0	30.8%	36.2%
3	0.301	≈ 0	32.6%	11.9%
4	0.161	0.36%	0	≈ 0

Linear dynamic analysis

The values of the maximum displacements of the same joints of the previous paragraph are shown in table 114. In addition, the relative percentages of variations at the LS DL are reported.

Table 114 – Maximum displacements calculated with the linear dynamic analysis for both main directions (X and Y) for the project solutions with hinged (HL) and rigid connections (RL)

Italian case study	Project solution	
LS DL	U1 (mm)	U2 (mm)
δ_{max} (Roof)	15.1	9.7
-Δ-	14.7%	31.2%

It can be seen that in terms of maximum top-displacements the reduction in transverse direction is around 30%, and 15% in longitudinal directions, as obtained with the steel exoskeleton.

The vulnerability analysis was carried out in terms of maximum stresses in the structural elements as described in Section 5.2.1.4. The vulnerability assessment carried out with dynamic linear analysis (force-based design) for LS SD was found to be satisfied with higher percentages of the design seismic loads.

$$65\% \leq E(a_g)_{LS SD} \leq 70\%$$

The same considerations reported for the steel exoskeleton are valid for the aluminium case.

Non-linear static analysis (pushover)

As reported above, the results of the modal analysis show that the first vibration mode can be considered in line with the requirement for the application of a pushover analysis, having more than 60% of the mass activated in the longitudinal direction, while along transverse direction the second and the third modes do not activate enough mass due to a torsional behaviour, caused by the presence of the garages at the ground floor, as happened for the initial state. For this reason, the results from the pushover analyses performed in transverse direction may be too conservative, especially with the modal force distribution, which is not reported here. This translates in consistent results along the longitudinal direction (X-U1), while for the transversal direction (Y-U2) the results are reported modifying the percentage of participating mass, imposing it equal to that activated by the first longitudinal mode to have consistent proportional results (less conservative).

Further analysis should be provided considering all the combinations required by the standards and exploiting adapting pushover analysis to consider the torsional components in transverse direction.

Once the analyses have been carried out for the design solution, the reference parameters described in Section 5.2.1.4 have been reported.

Project state, Italian case study (uniform force distribution – X)

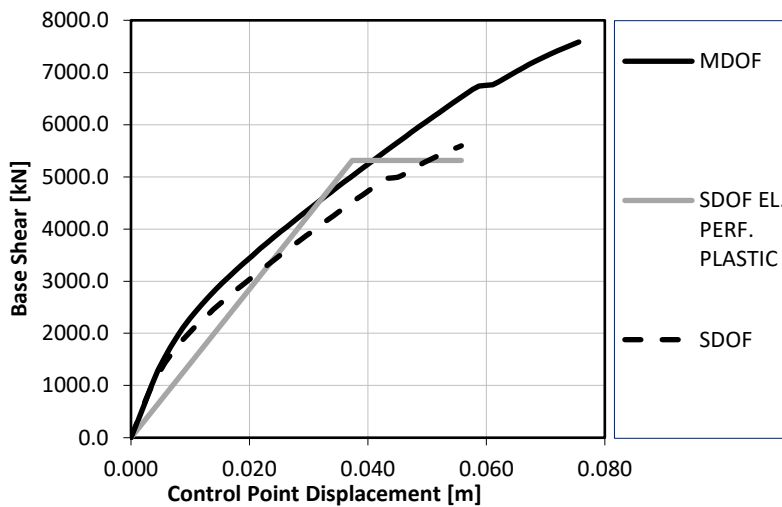

SDOF parameters.

$$\begin{aligned} \Gamma &= 1.356 \\ m^* &= 979.6 \text{ kNs}^2/\text{m} \\ k^* &= 142'266 \text{ kN/m} \\ T^* &= 0.521 \text{ s} \\ F_y^* &= 3'643.4 \text{ kN} \\ d_y^* &= 0.0374 \text{ m} \\ d_u^* &= 0.0558 \text{ m} \end{aligned}$$

Figure 154 – Representation of the capacity curves for both MDOF and SDOF systems and relative bilinearisation of the SDOF curve with the use of the parameters reported on the right; uniform force distribution along X-direction

Table 115 – Pushover analysis results; uniform force distribution along X-direction

Assessment results – LS Damage Limitation	
Displacement demand (D)	15.36 mm
Displacement capacity (C)	25.26 mm
D/C Ratio	60.8%
K_{70}	142'266 kN/m
Total shear capacity - V_{\max}	3'950 kN
PGA_D	0.081 g
PGA_C	0.164 g
C/D Ratio	100%
Assessment results – LS Significant Damage	
Displacement demand (D)	43.06 mm
Displacement capacity (C)	37.06 mm
D/C Ratio	116.2%
K_{70}	142'266 kN/m
Total shear capacity - V_{\max}	4'991 kN
PGA_D	0.221 g
PGA_C	0.211 g
C/D Ratio	96%
Assessment results – LS Near Collapse	
Displacement demand (D)	54.87 mm
Displacement capacity (C)	43.67 mm
D/C Ratio	125.6%
K_{70}	142'266 kN/m
Total shear capacity - V_{\max}	5'548 kN
PGA_D	0.278 g
PGA_C	0.235 g
C/D Ratio	85%

Project state, Italian case study (uniform force distribution – Y)

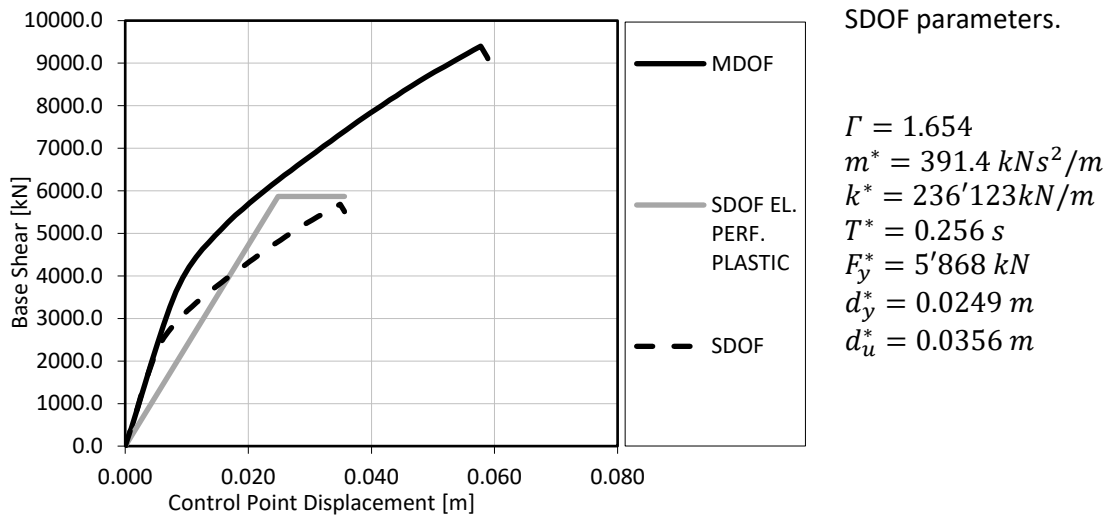

Figure 155 – Representation of the capacity curves for both MDOF and SDOF systems and relative bilinearisation of the SDOF curve with the use of the parameters reported on the right; uniform force distribution along Y-direction

Table 116 – Pushover analysis results; uniform force distribution along Y-direction

Assessment results – LS Damage Limitation	
Displacement demand (D)	5.466 mm
Displacement capacity (C)	6.217 mm
D/C Ratio	87.9%
K_{70}	236'123 kN/m
Total shear capacity - V_{max}	2'844 kN
PGA_D	0.081 g
PGA_C	0.179 g
C/D Ratio	100%
Assessment results – LS Significant Damage	
Displacement demand (D)	14.55 mm
Displacement capacity (C)	33.41 mm
D/C Ratio	43.5%
K_{70}	236'123 kN/m
Total shear capacity - V_{max}	7'169 kN
PGA_D	0.221 g
PGA_C	0.461 g
C/D Ratio	100%
Assessment results – LS Near Collapse	
Displacement demand (D)	18.54 mm
Displacement capacity (C)	13.86 mm
D/C Ratio	49%
K_{70}	236'123 kN/m
Total shear capacity - V_{max}	7'630 kN
PGA_D	0.278 g
PGA_C	0.485 g
C/D Ratio	100%

In order to evaluate the strengthening intervention by means of the external aluminium shear walls applied perpendicularly to the existing façades, the set of parameters introduced in Section 5.2.2.4 was compared before and after the application of the exoskeleton, obtaining results coinciding with the steel solution.

Exploitation of the exoskeleton

With the aim of assessing the exploitation of the exoskeleton, the part of horizontal force taken by the exoskeleton is extrapolated and compared with the total action. The values are derived from pushover analyses with uniform force distribution (as the worst case) and in relation to the limit states defined by the standards (Table 117).

Table 117 – Exploitation of the exoskeleton in terms of horizontal forces; calculated at the steps of the pushover analysis corresponding to the interested LS with modal force distribution for the project solution

Italian case study – Project state, steel exoskeleton				
PUSH-X Mass	Total Shear (kN)	Existing Structure (kN)	Steel Exoskeleton (kN)	Exploitation (%)
LS DL	3'950	3'041	909	23%
LS SD	4'991	3'444	1'547	31%
LS NC	5'548	3'195	1'886	34%
PUSH-Y Mass	Total Shear (kN)	Existing Structure (kN)	Steel Exoskeleton (kN)	Exploitation (%)
LS DL	2'844	2'503	341	12%
LS SD	7'169	5'305	1'864	26%
LS NC	7'630	5'494	2'136	28%

Consistent with the results obtained for the steel exoskeleton, the exploitation of the exoskeleton is around 25-30% in both directions.

5.2.3.5 Verifications of the exoskeleton

The verifications on the aluminium profiles were done manually, by checking the most stressed elements identified in the external structure. The main checks carried out are listed below.

Classification of cross-sections

The classification of the cross-sections is necessary to evaluate the elements that are not able to develop a plastic hinge with the rotation capacity required for the plastic analysis, due to the occurrence of local buckling phenomena. The slenderness parameter β from [126] defines the susceptibility of a plane part to local buckling (5.31).

$$\beta = \eta b/t \quad (5.31)$$

where

- b ; - is the width of a cross-section,
- t ; - is the thickness of a cross-section;
- η ; - is the stress gradient factor given by expressions:

$$\eta = 0,70 + 0,30\psi \quad 1 \geq \psi \geq -1 \quad (5.32)$$

$$\eta = 0,80/(1 - \psi) \quad \psi < -1 \quad (5.33)$$

ψ is the ratio of the stresses at the edges of plate under consideration related to the maximum compressive stress. Once the parameter β is calculated, is compared with the slenderness parameters β_1 , β_2 and β_3 shown in §6.1.4.4 of the Eurocode 9 [126]. The evaluation of the classes was carried out for the different aluminium elements with the more conservative load combinations.

Considering values of slenderness β_n indicated in Table 118, the classification was made considering the internal loads shown for each structural element in Table 119. The coefficients ψ and η are then determined together with β (Table 120).

Table 118 – Slenderness parameters beta divided for internal and outstanding parts for the typology of section – Source Table 6.2 of [126]

	β_1/ε	β_2/ε	β_3/ε
Diagonal bracing (internal part)	11	16	22
Diagonal bracing (outstand part)	3	4.5	6
Beam (internal part)	11	16	22
Column (internal part)	11	16	22

$\varepsilon = \sqrt{250/f_o}, f_o$ in N/mm^2

Table 119 – Aluminium structural elements with related maximum internal stresses

Frame	Type	Location (m)	N_c [N]	N_t [N]	M_x [Nmm]	T_y [N]	M_y [Nmm]	T_x [N]
2131	Bracing	0	154'298	147'516	-1'253'900	709	-62'900	-22
		3.417	154'298	147'516	-1'082'500	709	12'700	-22
1769	Longitudinal beam	0	51'262	51'569	-883'900	-6'212	0	0
		1.46	51'262	51'569	3'650'800	0	0	0
		2.92	51'262	51'569	-883'800	6'212	0	0
2191	Transverse beam	0	34'686	38'514	13'353'000	-21'856	13'701'600	19'710
		1.5	34'686	38'514	-14'922'400	23'883	-11'133'200	19'710
1944	Connecting beam	0	36'744	41'150	-21'221'900	-70'361	-19'667'300	-43'883
		0.56	36'744	41'150	-24'114'700	-70'223	4'960'500	-43'883
1443	Column A	0	549'905	350'206	-68'229'500	-45'548	-38'048'700	-15'581
		2,61	549'905	350'206	71'610'700	-45'548	10'120'000	-15'581
1444	Column B	0	297'630	176'188	-45'620'800	-30'164	-3'249'500	-1'462
		3,07	297'630	176'188	46'985'500	-30'164	4'816'600	-1'462

Table 120 – Cross-section classification of the most stressed aluminium structural elements

Frame	Type	Part	σ_z [N/mm ²]	ψ	η	β	Part class	Section class	
2131	Bracing	Outstand	-84.10	-90.54	0.93	0.98	4.80	3	3
		Internal	-62.02	-90.54	0.69	0.91	8.88	1	
1769	Longitudinal beam	Internal h.	-10.95	-10.95	1.00	1.00	7.00	1	3
		Internal v.	-0.14	-10.95	0.01	0.70	16.31	3	
2191	Transverse beam	Internal h.	+14.03	-61.07	-0.23	0.63	4.42	1	3
		Internal v.	-21.52	-61.07	0.35	0.81	18.68	3	
1944	Connecting beam	Internal h.	+18.50	-89.29	-0.21	0.64	4.47	1	3
		Internal v.	-26.44	-89.29	0.30	0.79	18.28	3	
1443	Column A	Internal h. p.	-37.35	-77.11	0.48	0.85	15.52	2	3
		Internal v. p.	-5.81	-77.11	0.08	0.72	13.26	2	
		Internal h. s.	-36.69	-63.21	0.58	0.87	16.05	3	
		Internal v. s.	-11.30	-69.36	0.16	0.75	13.75	2	
1444	Column B	Internal h. p.	-58.63	-67.47	0.87	0.96	40.03	4	4
		Internal v. p.	+18.74	-67.47	-0.28	0.62	25.69	4	
		Internal h. s.	-49.90	-50.66	0.99	1.00	41.48	4	
		Internal v. s.	+12.39	-65.74	-0.19	0.64	26.81	4	

Verification of cross-sections

In this first phase the resistance of cross-section is defined considering the gross cross-section A_g , the presents of holes and heat affected zones are neglected. The only reduction of cross-section area has been considered for elements of class 4, where the effective area A_{eff} is provided.

The verifications for the maximum stresses reported in Table 119 are shown below (Tables X-Y), with reference to the Eurocode 9 [126].

Tension §6.2.3, [126]

$$\frac{N_{Ed}}{N_{Rd}} \leq 1 \quad N_{t,Rd} = A_g f_0 / \gamma_{M1} \quad (5.34)$$

Table 121 – Aluminium members checks for tensile stress

Frame	Type	N_{Ed} (N)	$N_{t,Rd}$ (N)	$N_{Ed}/N_{t,Rd}$
2131	Bracing	147'516	192'000	0.77
1769	Longitudinal beam	51'569	2'186'363	0.02
1443	Column A	350'206	6'023'491	0.06
1444	Column B	176'188	2'568'085	0.07

Compression §6.2.4, [126]

$$\frac{N_{Ed}}{N_{c,Rd}} \leq 1 \quad N_{c,Rd} = A_g f_0 / \gamma_{M1} \quad (5.35)$$

Table 122 – Aluminium members checks for compressive stress

Frame	Type	N_{Ed} (N)	$N_{c,Rd}$ (N)	$N_{Ed}/N_{c,Rd}$
1769	Longitudinal beam	51'569	2'186'363	0.02
1443	Column A	549'905	6'023'491	0.09
1444	Column B	297'630	2'568'085	0.12

Bending moment §6.2.5, [126]

$$\frac{M_{Ed}}{M_{Rd}} \leq 1 \quad M_{0,Rd} = \alpha W_{el} f_0 / \gamma_{M1} \quad (5.36)$$

where α is the shape factor which depends on the class of the section.

Table 123 – Aluminium members checks for bending stress

Frame	Type	Location	$M_{x,Ed}$ (Nmm)	$M_{y,Ed}$ (Nmm)	$M_{x,Rd}$ (Nmm)	$M_{y,Rd}$ (Nmm)	$\max(M_{Ed}/M_{Rd})$
1944	Connecting beam	0	21'221'900	19'667'300	159'633'387	86'254'842	0.40
		0.56	24'114'700	4'960'500	159'633'387	86'254'842	0.59
1443	Column A	0	-68'229'500	-38'048'700	452'358'650	452'358'650	0.15
		2.61	71'610'700	10'120'000	452'358'650	452'358'650	0.16
1444	Column B	0	-45'620'800	-3'249'500	162'826'953	134'343'087	0.28
		3.07	46'985'500	4'816'600	162'826'953	134'343'087	0.29

Shear §6.2.6, [126]

$$\frac{V_{Ed}}{V_{Rd}} \leq 1 \quad (5.37)$$

for non-slender plates:

$$V_{Rd} = A_v \frac{f_0}{\sqrt{3}\gamma_{M1}} \quad A_v = \sum_{i=1}^n (h_w t_w)_i \quad (5.38)$$

where h_w is the depth of the web between flanges and t_w the web thickness.

For slender plates:

$$V_{Rd} = v_l b t \frac{f_0}{\sqrt{3}\gamma_{M1}} \quad (5.39)$$

where

- $v_l = 17t\varepsilon \frac{\sqrt{\kappa_\tau}}{b}$ but not more than $v_l = \kappa_\tau \frac{430t^2\varepsilon^2}{b^2}$ and $v_l \leq 1$;
- $\kappa_\tau = 5.34 + 4.00(b/a)^2$ if $a/b \geq 1$;
- $\kappa_\tau = 4.00 + 5.34\left(\frac{b}{a}\right)^2$ if $\frac{a}{b} \geq 1$;
- $\varepsilon = \sqrt{250/f_0}$;
- a is the length of the plate in the direction of compression;
- b is the width across the plate.

Table 124 – Aluminium members checks for shear stress

Frame	Type	$V_{x,Ed}$ (N)	$V_{y,Ed}$ (N)	$V_{x,Rd}$ (N)	$V_{y,Rd}$ (N)	$\max(V_{Ed}/V_{Rd})$
1944	Connecting beam	282'683	5'923	511'742	840'622	0.34
1443	Column A	71'332	20'990	1'228'181	1'228'181	0.06
1444	Column B	11'443	53'267	391'596	516'307	0.10

Combined bending and axial force §6.2.9.2, [126]

$$\left(\frac{N_{Ed}}{\omega_0 N_{Rd}}\right)^\psi + \left[\left(\frac{M_{x,Ed}}{\omega_0 M_{x,Rd}}\right)^{1.7} + \left(\frac{M_{y,Ed}}{\omega_0 M_{y,Rd}}\right)^{1.7}\right]^{0.6} \leq 1.00 \quad (5.40)$$

where

- $\psi = 1.3$ for hollow section;
- $\omega_0 = 1$ for sections without localised welds or holes;
- $M_{x,Rd} = \alpha_x W_{x,el} \frac{f_0}{\gamma_{M1}}$;
- $M_{y,Rd} = \alpha_y W_{y,el} \frac{f_0}{\gamma_{M1}}$;
- α_x, α_y are the shape factors for bending about the x and y axis.

Table 125 – Aluminium members checks for combined bending and axial forces

Frame	Type	Location	$\left(\frac{N_{Ed}}{\omega_0 N_{Rd}}\right)^\psi + \left[\left(\frac{M_{x,Ed}}{\omega_0 M_{x,Rd}}\right)^{1.7} + \left(\frac{M_{y,Ed}}{\omega_0 M_{y,Rd}}\right)^{1.7}\right]^{0.6} \leq 1.00$
1944	Connecting beam	0	0.40
		0.56	0.59
1443	Column A	0	0.18
		2.61	0.17
1444	Column B	0	0.29
		3.07	0.30

Flexural buckling §6.3.3.1, [126]

$$\left(\frac{N_{Ed}}{\chi_{min}\omega_x N_{Rd}}\right)^{\psi_c} + \frac{1}{\omega_0} \left[\left(\frac{M_{x,Ed}}{M_{x,Rd}}\right)^{1.7} + \left(\frac{M_{y,Ed}}{M_{y,Rd}}\right)^{1.7} \right]^{0.6} \leq 1.00 \quad (5.41)$$

where

- $\psi_c = 0.8$;
- χ_{min} is the reduction factor for buckling as the minor between: $\chi_x = \frac{1}{\phi_x + \sqrt{\phi_x^2 - \bar{\lambda}_x}}$; $\chi_y = \frac{1}{\phi_y + \sqrt{\phi_y^2 - \bar{\lambda}_y}}$;
- $\phi_x = 0.5 \left(1 + \alpha(\bar{\lambda}_x - \bar{\lambda}_0) + \bar{\lambda}_x^2 \right)$
- $\phi_y = 0.5 \left(1 + \alpha(\bar{\lambda}_y - \bar{\lambda}_0) + \bar{\lambda}_y^2 \right)$
- $\bar{\lambda}_x = \frac{L_{cr}}{i_x} \frac{1}{\pi} \sqrt{\frac{A_{eff} f_0}{A E}}$;
- $\bar{\lambda}_y = \frac{L_{cr}}{i_y} \frac{1}{\pi} \sqrt{\frac{A_{eff} f_0}{A E'}}$;
- α is an imperfection factor, 0.2 for material class A;
- $\bar{\lambda}_0$ is the limit of the horizontal plateau, 0.1 for material class A;
- L_{cr} is the buckling length in the bucking plane considered;
- i_x and i_y are the radiuses of gyration about the relevant axis, determined using the properties of gross-section.

Table 126 – Aluminium members checks for combined bending and axial forces

Frame	Type	Location	$\left(\frac{N_{Ed}}{\chi_{min}\omega_x N_{Rd}}\right)^{\psi_c} + \frac{1}{\omega_0} \left[\left(\frac{M_{x,Ed}}{M_{x,Rd}}\right)^{1.7} + \left(\frac{M_{y,Ed}}{M_{y,Rd}}\right)^{1.7} \right]^{0.6} \leq 1.00$
1944	Connecting beam	0	0.423
		0.56	0.615
1443	Column A	0	0.321
		2.61	0.306
1444	Column B	0	0.409
		3.07	0.416

5.2.3.6 Results comparison and final quantities

The comparison of the parameters introduced in Section 5.2.2.4 has been reported, concerning the results of the non-linear static analysis for the application of the steel exoskeleton with aligned results obtained with the aluminium solution. It can be noted that the strengthening provided by the steel external structure is significant in relation to the seismic demand, as shown also by the results from the linear dynamic analysis. The masonry walls are decisive for the response of the structure and stiff along their main plan in transverse direction, providing sufficient capacity and limiting displacement capacity in the longitudinal direction where short bearing walls with openings represent weak points.

While the LS DL does not represent an issue due to the stiffness of the masonry walls, LS SD and LS NC are characterised by seismic vulnerability of the structure. Linear dynamic analysis resulted more conservative, probably including effects of torsional behaviour otherwise lost by the pushover in the same direction. On the other hand, the first vibration mode represents the most vulnerable behaviour of the existing structure since the displacements in longitudinal direction, higher due to the presence of short walls, result in failures of the latter under the design seismic loads. Therefore, the longitudinal direction represents the weaker direction of the existing building, and it is also the direction where it is possible to derive consistent results out of the non-static linear analyses. From these it can be noted (for both steel and

aluminium solutions) that with the application of the external exoskeleton, there is an increase in the PGA from 41% to 96% of the design seismic action along the weakest direction, and from 97% to 100% in the transverse direction. The more conservative force-based approach of the linear dynamic analysis stated an improvement from 25% to 65% of the design seismic action at the LS SD.

Furthermore, a preliminary impact in terms of weight and costs of the structure is presented.

Capacity curves comparison

The capacity curves relating to the initial state and design cases in steel and aluminium are shown below for both the main directions. For each curve the coordinates corresponding to the exceedance of the DL, SD and NC limit states are also indicated.

The capacity curves in Figure 156 show how the application of the exoskeleton leads to an increase in strength and stiffness, which translates into higher values of collapse-related acceleration, due to a different distribution of damage and displacements over the height of the building that allowed higher displacements to be reached in the design state. This is particularly true for the longitudinal direction (X), while in the transverse direction the behaviour is similar to that which occurring for the Athens case study, with an increase in displacement capacity in LS DL and a decrease in ultimate displacements related to SD and NC. It is also possible to record the different behaviour of the existing building in the two directions, indicating a higher capacity in the transverse direction. Afterwards, the external structure is inserted, implying a greater capacity increase along the transverse direction due to a greater development of the building on that side which allows a greater number of metal frames and bracings.

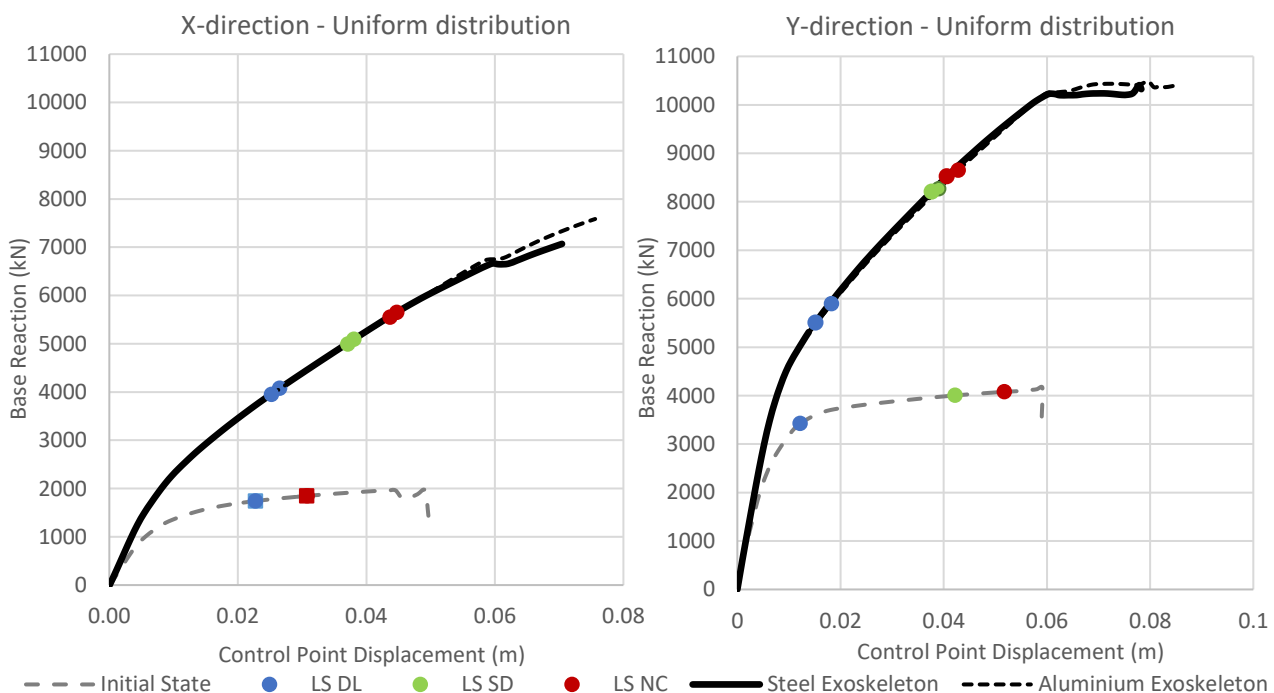

Figure 156 – Capacity curves obtained by pushover analyses with uniform distribution of forces, in both main directions, before and after the application of the steel and aluminium based exoskeletons

Finally, as underlined from the coincidence of the black curves, the same monotonic seismic response was recorded for the steel and the aluminium exoskeletons.

Total weight and costs

A brief report of the material quantities and the relative costs is now presented. After an evaluation of the amount of profiles used (Tables 127 and 131), with reference to an Italian price table [147], it was possible to obtain a basic cost of the steel used (Table 128). Finally, considering the treatments of the steel (Table 129) a total cost for the whole exoskeleton, only excluding the foundation, was calculated (Table 130).

A comparison with the aluminium solution is made, considering the advantage of reducing the costs of maintenance and using a unit cost provided directly from ALIVA Srl.

Steel project solution

Table 127 – Summary of the quantities of the steel exoskeleton

Section Text	Object Type	Total Length (m)	Total Weight (kN)
HE280A	Column	732.84	548.858
HE180A	Trans. Beam	283.84	98.971
IPE220	Long. Beam	657.56	169.052
PIPE-D76.1X3.2	Bracing	648.759	36.599
			853.48 kN = 87'029.36 kg

Table 128 – Cost of the steel used

Calculation of the cost for the steel material		
	Total Weight (kg)	Cost (€)
Total simple profiles (2.90€/kg)	83'297.36	241'562.33
Total pipe profiles (4.14€/kg)	3'732.06	15'450.73
Material total		257'013 €

Table 129 – Cost of the steel treatments

Calculation of the cost for the steel treatments		
	Total Weight (kg)	Cost – Galvanization (€)
Total profiles	87'029.36	57'439
	Total surface (m ²)	Cost – Final paint (€)
Total profiles	2'178.05	30'950
Total for treatments		88'389 €

Table 130 – Total cost of the steel solution

TOTAL	
	Costs (€)
Total carpentry	257'349
Total steel treatments	88'389
TOTAL	345'738 €

Aluminium project solution

Table 131 – Summary of the quantities of the aluminium exoskeleton; the cost of the material is then calculated on the total amount on the basis of the unit cost provided by ALIVA Srl

Section Text	Object Type	Total Length (m)	Total Weight (kN)
BEAM	Beam	941.4	231.647
COLUMN A	Column	352.16	238.736
COLUMN B	Column	380.68	151.132

DIAGONAL	Bracing	648.75924	36.292
-	-	-	657.807 kN = 67'076.58 kg
		Total Cost (5.5 €/kg)	368'921.19 €
		+15% for plates	424'259.37 €

Since a comparable price between aluminium and steel (coming from the same source and including the same related works) is not available, it is not possible to make a more precise comparison between the two materials. In fact, the price provided by ALIVA Srl does not include the construction procedures/works and the possible profit of the supplier. On the other hand, regarding the steel, the considered price list takes into account the supplier's profit, a certain type of transport and assembly, as well as additional components such as connection plates etc. From the mere cost comparison, steel is cheaper, with a total cost of 345'700 € against 368'900 € for the aluminium solution (without considering the cost of treatments for aluminium or the 15% additional material for the plates which would further increase the total cost of aluminium to 424'300 €). Together with the results presented in Section 4.4, the results of this chapter show that structural aluminium could be a valid alternative to steel for seismic strengthening, disregarding the need for further experimental investigations and updated standards in seismic zones, but it proves to be an expensive and less sustainable option, compared to a more established material, such as steel, which would reduce the variables in terms of analysis and calculation and also simplify the construction procedures. Aluminium, in fact, is locally weakened in the heat zones, created by welding and is therefore less inclined to adapt to customised situations. On the other hand, if carefully designed with specific tolerances and pre-assembled joints, it would be an interesting practical and lightweight alternative to be further investigated.

5.2.4 Italian seismic classification – Sisma Bonus

The Italian legislation provides for a seismic risk classification aimed at defining a level of vulnerability of the existing buildings and assessing the retrofit strategies implemented through structural interventions. Annex A of the DM 58 (28/02/2017), entitled *Linee guida per la classificazione del rischio sismico delle costruzioni (Sisma Bonus)* [156], defines eight classes of seismic risk and allows obtaining economic incentives to mitigate the cost of the interventions based on the class-improvement.

The method is based on the application of the seismic analyses foreseen by the Italian national standards and refers to two parameters:

- the expected average annual loss (PAM, *perdita annuale media attesa*), which takes into account the economic losses associated with damage to structural and non-structural elements. It refers to the reconstruction cost (CR) of the building without its contents;
- the safety index (IS-V) of the structure defined as the ratio of the peak ground acceleration (PGA) that determines the achievement of the LS SD (SLV for Italian standards [138]).

Once the PGA values linked to the SLO, SLD, SLV and SLC performance levels have been determined [138], it is possible to assign the PAM and IS-V classes, identifying the vulnerability of the building before and after the retrofit. The eight risk classes range from A+ (low risk) to G (high risk).

For simplicity, the results are shown with respect to the analysis in the X direction as the most vulnerable and characteristic of the first vibration mode of the Italian case study. Furthermore, only the steel project solution is considered, assuming that similar results can be obtained with the aluminium solution.

5.2.4.1 Initial State – Sisma Bonus

General building data, necessary for the application of the method are listed below.

- Construction typology – Ordinary
- Importance class – II

- Design working life – 50 years
- Soil category – C
- Topographic condition – T1

The PGA values of capacity and demand are given in Table 132. The limit states indicated by the Italian national standard are linked to these values characterised by a specific reference return period (T_{rD}) and probability of exceedance in 50 years (P_{VR}).

Table 132 – Capacity acceleration values and limit states reference value

NTC2018 [138]	Eurocodes [11]	$PGA_C(g)$	$PGA_D(g)$	$P_{VR} (%)$	$T_{rD}(years)$
SLD	LS DL	0.080	0.074	63	50
SLV	LS SD	0.091	0.221	10	475
SLC	LS NC	0.091	0.278	5	975

with

- T_{rD} - reference return period of the seismic action for the associated limit state
- P_{VR} - reference probability of exceedance in 50 years

Given PGA capacity values, the corresponding return periods are determined with (5.42). These values represent the return periods of earthquakes with such accelerations.

$$T_{rC} = T_{rD} \left(\frac{PGA_C}{PGA_D} \right)^\eta \quad (5.42)$$

- $\eta = \frac{1}{0.49}$ – if $a_g \geq 0.25g$
- $\eta = \frac{1}{0.43}$ – if $0.25g \geq a_g \geq 0.15g$
- $\eta = \frac{1}{0.356}$ – if $0.15g \geq a_g \geq 0.05g$
- $\eta = \frac{1}{0.34}$ – if $0.05g \geq a_g$

Table 133 – Reference return periods associated to the capacity acceleration values

$T_{rC}(SLD) = 39 \text{ years}$	$T_{rC}(SLV) = 39 \text{ years}$	$T_{rC}(SLC) = 73 \text{ years}$
----------------------------------	----------------------------------	----------------------------------

For the calculation of the return time T_{rC} associated with the attainment of the operational limit states (SLO and SLD) it is necessary to assume the lowest value between that obtained for these limit states and that assessed for the SLV limit state. It is assumed that the SLV limit state cannot be reached without having passed the previous performance levels (SLO and SLD). For each of the periods identified in Table 133, the value of the annual average frequency of exceedance $\lambda = 1/T_{rC}$ is determined.

Then, for each of the considered limit states, the value of the percentage of reconstruction cost (CR) according to the table in [156] is associated with the corresponding λ value. Through the definition of SLO, SLR and SLID as indicated by [156], depending on the results obtained for the available limit states (SLD, SLV and SLC), it was possible to determine six points that compose the PAM curve. The points and the curve are shown below (Table 134 and Figure 157).

Table 134 – Percentages of CR associated with the annual average frequency of exceedance λ

Limit state [138, 156]	From [156]	λ	CR (%)
SLR	given	0	100
SLC	$\lambda = 1/T_{rC}$	0.014	80
SLV	$\lambda = 1/T_{rC}$	0.026	50
SLD	$\lambda = 1/T_{rC}$	0.026	15
SLO	$\lambda_{SLO} = 1.67 \cdot \lambda_{SLD}$	0.043	7
SLID	given	0.1	0

with

- SLR – Limit state of reconstruction
- SLID – Limit state of damage start

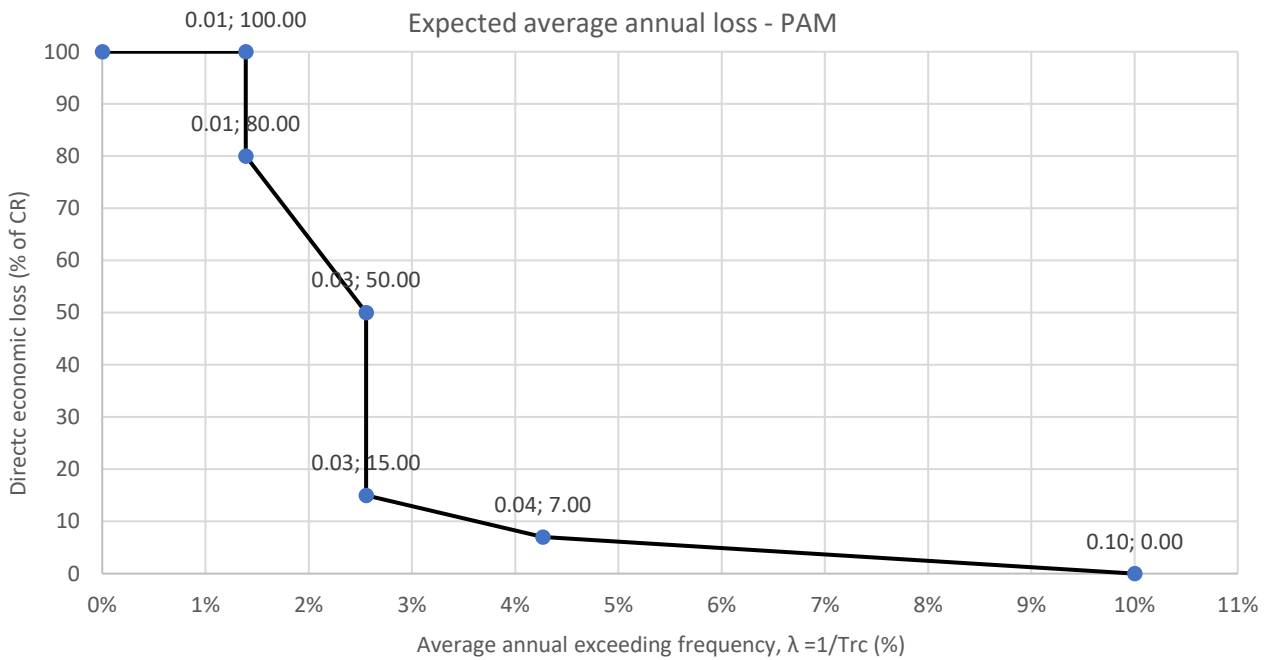

Figure 157 – PAM curve representing the expected average annual loss of the initial state

Finally, the area subtended by the PAM curve was evaluated in percentage value with the formula (5.43), where *i* represents the generic limit state.

$$PAM = \sum_{i=2}^5 [\lambda(SL_i) - \lambda(SL_{i-1})] \cdot \frac{[CR\%(SL_i) + CR\%(SL_{i-1})]}{2} + \lambda(SL_1) \cdot CR\%(SLR) \quad (5.43)$$

Using the tables reported in [156], it was then possible to verify in which class the building belongs by evaluating the results of (5.43) and the vulnerability index IS-V (Table 135). The IS-V is simply the ratio between capacity and demand in terms of acceleration at the LS SD (SLV). Once the classification is found in the two tables, the lower class resulting from the two values represents the vulnerability.

Table 135 – Final class of risk for the initial state

PAM		IS-V	
4.36%		41.12%	
Perdita Media Annuata attesa (PAM)	Classe PAM	Indice di Sicurezza	Classe IS-V
PAM ≤ 0,50%	A ⁺ _{PAM}	100% < IS-V	A ⁺ _{IS-V}
0,50% < PAM ≤ 1,0%	A _{PAM}	100% ≤ IS-V < 80%	A _{IS-V}
1,0% < PAM ≤ 1,5%	B _{PAM}	80% ≤ IS-V < 60%	B _{IS-V}
1,5% < PAM ≤ 2,5%	C _{PAM}	60% ≤ IS-V < 45%	C _{IS-V}
2,5% < PAM ≤ 3,5%	D _{PAM}	45% ≤ IS-V < 30%	D _{IS-V}
3,5% < PAM ≤ 4,5%	E _{PAM}	30% ≤ IS-V < 15%	E _{IS-V}
4,5% < PAM ≤ 7,5%	F _{PAM}	IS-V ≤ 15%	F _{IS-V}
7,5% ≤ PAM	G _{PAM}		

The initial state of the Italian case study is classified in class G with reference to [156].

5.2.4.2 Project state (steel) – Sisma Bonus

The PGA values of capacity and demand for the project state are given in Table 136. The limit states indicated by the Italian national standard are linked to these values characterised by a specific reference return period (T_{rD}) and probability of exceedance in 50 years (P_{VR}).

Table 136 – Capacity acceleration values and limit states reference value

NTC2018 [138]	Eurocodes [11]	$PGA_C(g)$	$PGA_D(g)$	$P_{VR} (%)$	$T_{rD}(years)$
SLD	LS DL	0.166	0.081	63	50
SLV	LS SD	0.212	0.221	10	475
SLC	LS NC	0.233	0.278	5	975

Given PGA capacity values, the corresponding return periods are determined with (5.42) and reported in Table 137. These values represent the return periods of earthquakes with such accelerations.

Table 137 – Reference return periods associated to the capacity acceleration values

$T_{rC}(SLD) = 379 \text{ years}$	$T_{rC}(SLV) = 424 \text{ years}$	$T_{rC}(SLC) = 644 \text{ years}$
-----------------------------------	-----------------------------------	-----------------------------------

For each of the periods identified in Table 137, the value of the annual average frequency of exceedance $\lambda = 1/T_{rC}$ is determined. Then, for each of the considered limit states, the value of the percentage of reconstruction cost (CR) according to the table in [156] is associated with the corresponding λ value. The coordinates and the curve are shown below (Table 138 and Figure 158).

Table 138 – Percentages of CR associated with the annual average frequency of exceedance λ

Limit state [138, 156]	From [156]	λ	CR (%)
SLR	given	0	100
SLC	$\lambda = 1/T_{rC}$	0.0016	80
SLV	$\lambda = 1/T_{rC}$	0.0024	50
SLD	$\lambda = 1/T_{rC}$	0.0027	15
SLO	$\lambda_{SLO} = 1.67 \cdot \lambda_{SLD}$	0.0044	7
SLID	given	0.1	0

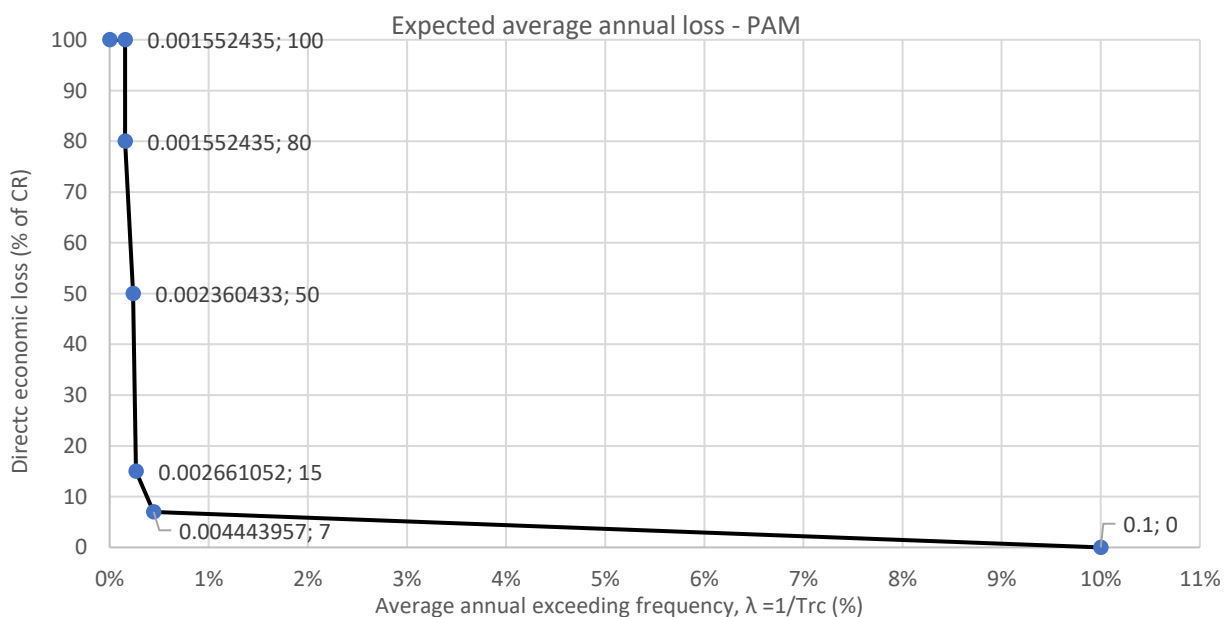

Figure 158 – PAM curve representing the expected average annual loss of the project state

Finally, the area subtended by the PAM curve was evaluated in percentage value with the formula (5.43).

Using the tables reported in [156], it was then possible to verify in which class the building belongs by evaluating the results of (5.43) and the vulnerability index IS-V (Table 139). The IS-V is simply the ratio between capacity and demand in terms of acceleration at the LS SD (SLV). Once the classification is found in the two tables, the lower class resulting from the two values represents the vulnerability.

Table 139 – Final class of risk for the project state

PAM		IS-V	
0.20%		96%	
Perdita Media Annuale attesa (PAM)	Classe PAM	Indice di Sicurezza	Classe IS-V
PAM ≤ 0,50%	A ⁺ _{PAM}	100% < IS-V	A ⁺ _{IS-V}
0,50% < PAM ≤ 1,0%	A _{PAM}	100% ≤ IS-V < 80%	A _{IS-V}
1,0% < PAM ≤ 1,5%	B _{PAM}	80% ≤ IS-V < 60%	B _{IS-V}
1,5% < PAM ≤ 2,5%	C _{PAM}	60% ≤ IS-V < 45%	C _{IS-V}
2,5% < PAM ≤ 3,5%	D _{PAM}	45% ≤ IS-V < 30%	D _{IS-V}
3,5% < PAM ≤ 4,5%	E _{PAM}	30% ≤ IS-V < 15%	E _{IS-V}
4,5% < PAM ≤ 7,5%	F _{PAM}	IS-V ≤ 15%	F _{IS-V}
7,5% ≤ PAM	G _{PAM}		

The retrofit by means of a steel exoskeleton (comparable results would be obtained with the aluminium solution) of the Italian case study allows to pass from class G to A with reference to [156].

The comparison of the two graphs representing the expected mean annual loss (PAM) for the initial and the project state allows to show graphically the savings in terms of possible costs related to seismic events occurring in the area where the existing structure is located. These savings are represented by the area between the two curves (Figure 159).

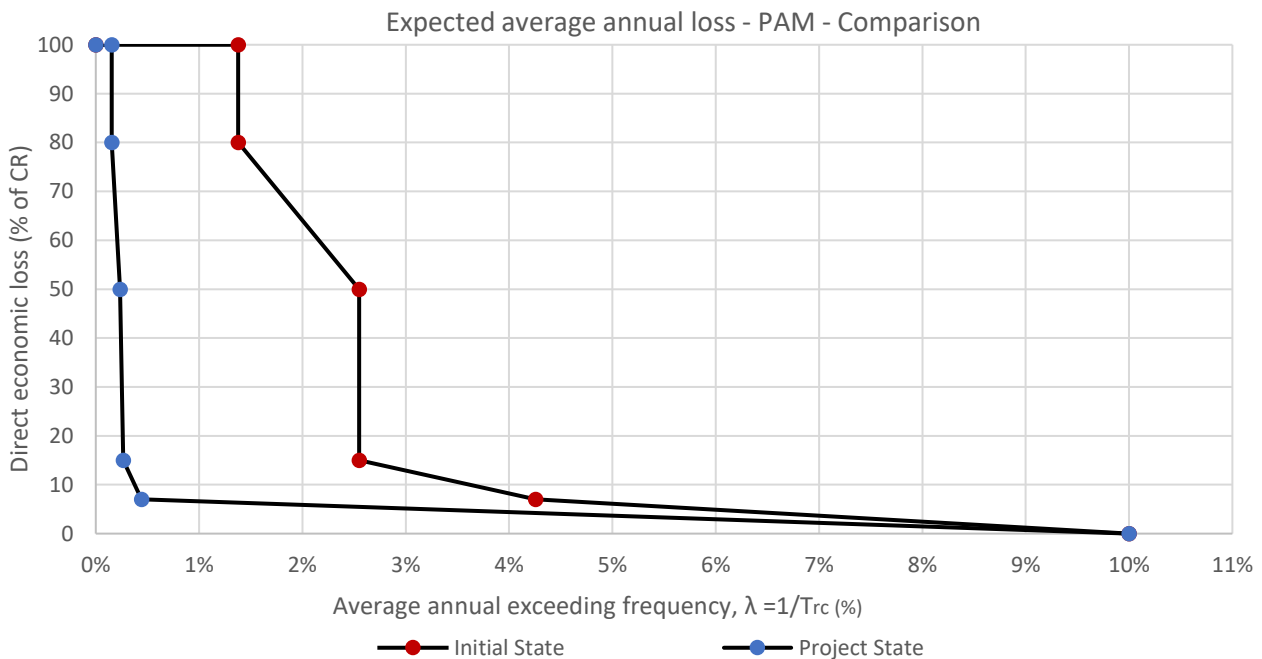

Figure 159 – Comparison of the PAM curves before and after the application of the steel exoskeleton

The strengthening strategy, even if it involves a substantial initial investment, protects the building from damage in case of seismic events (strong and rare or light and frequent), saving costs related to repair and replacement, maintaining the existing heritages, and ensuring the safety for inhabitants.

5.3 The Romanian case study – the timber exoskeleton

The third building is located in Brasov, the seventh most populated city in Romania. The metropolitan area consists of around 370'000 inhabitants. It is located in the central part of the country, about 170 km north of Bucharest and 380 km from the Black Sea, with an altitude of 600 m above sea level. It is surrounded by the southern Carpathians, and it is part of the Transylvania region.

The case study is a rectangular shaped residential building that was designated to become a social house in 2015 and is currently still used as a facility to host homeless people [28]. Figure 160 shows an overall view of the site. The building from the basement consists of a ground floor and four upper floors. The building is located at Steet Zizinului, n. 126 (Lat. 45.600, Long. 25.582), with an altitude of 590.5 m above sea level, in an area of around 970 m² with built surface of circa 1'800 m².



Figure 160 – a) and b) Location and three-dimensional view of the Social House in Brasov; c) photo of the north façade – Source: [140]

According to the seismographic history of Romania, the areas of Timis, Caras Severin, Satu Mare and Constanta are the safest seismic zones, as well as the border between Suceava and Maramures (Figure 161). Almost as safe are the areas between Oradea, Cluj, Deva and Bistrita, while between Sibiu and Brasov this area is characterised by a medium seismic risk. The most dangerous areas for inhabitants in the event of an

earthquake are Bucharest, Ploiesti, Buzau, Focsani, or Iasi and all zones between them, followed by Roman, Bacau, Pitesti, Giurgiu, and all areas within this perimeter. In the intermediate risk zones, there are also Cernavoda and Tulcea. The seismic ground motion is described by the a_{gR} acceleration which denotes the peak ground acceleration (PGA) of reference on a type A soil (Figure 161).

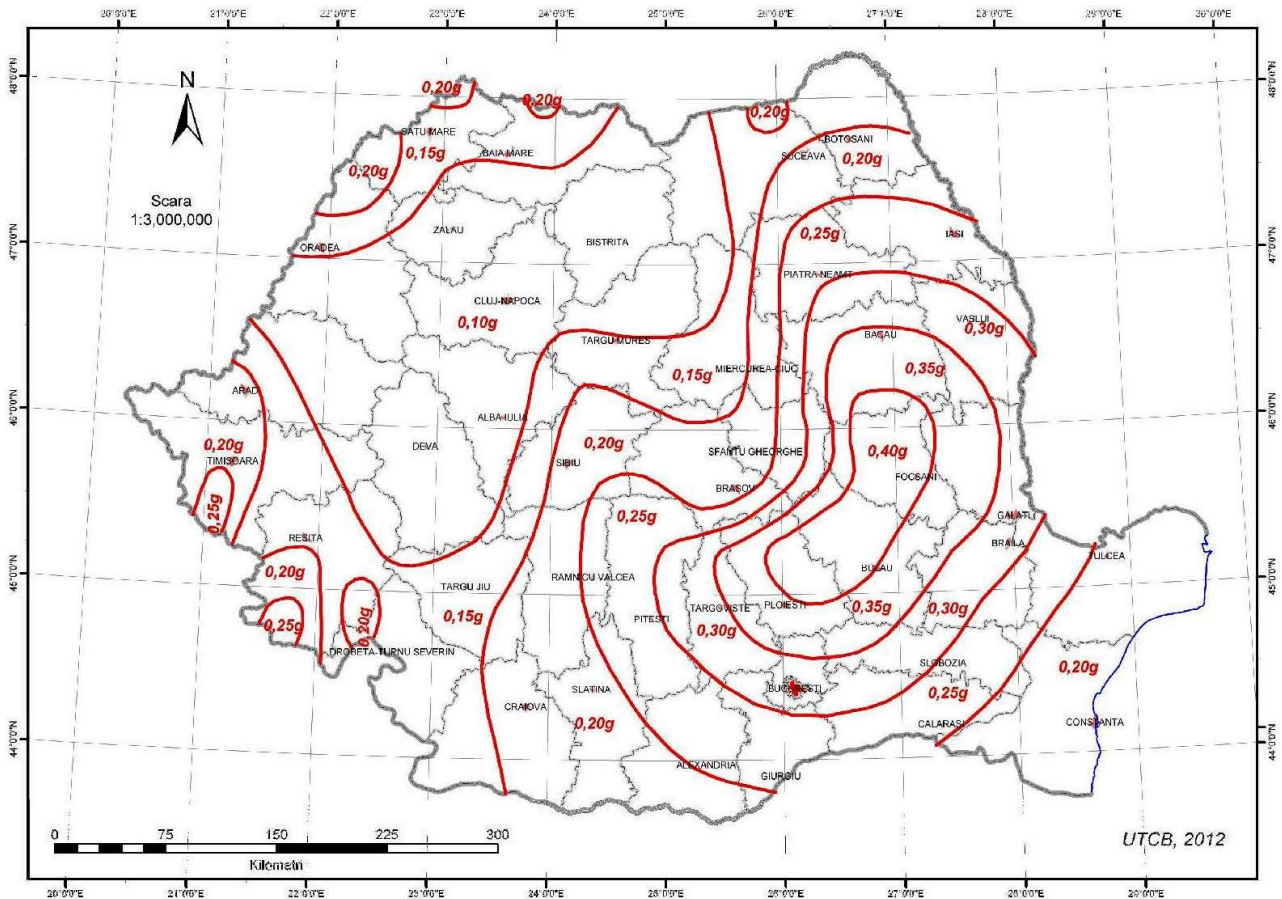

Figure 161 – Seismic risk map of Romania expressed in ground acceleration with 20% probability of exceedance in 50 years according to the seismological data – Source: [157]

According to the provisions of the Romanian national standards P 100-1/2013 [158], the construction is in the third importance class, which corresponds to a γ_I value of 1.0 in the European standards [12] (Table 140). Furthermore, from [157] it can be reported that Brasov is characterised by a ground acceleration of $a_g = 0.2$ g (with 20% probability of exceedance in 50 years), a period $T_c = 0.70$ s and a snow load of 2.0 kN/m^2 .

Table 140 – Class reference for building – Source: [12]

Class	γ_I	Use of building
I	0.8	Buildings of minor importance for public safety, e.g., agricultural buildings, etc.
II	1.0	Ordinary buildings, not belonging in the other categories.
III	1.2	Buildings whose seismic resistance is of importance, in view of the consequences associated with a collapse, e.g., schools, assembly halls, etc.
IV	1.4	Buildings whose integrity during earthquakes is of vital importance for civil protection, e.g., hospitals, fire stations, power plants, etc.

The case study was built in 1972, and during 2015 investigated in order to be renovated as social house [157]. The building has a rectangular shape with plan dimensions of 25×14.5 m, an overall height from the base level of 12.5 m with 2.40 m net height for each floor. The net heated volume is around $2'400 \text{ m}^3$. The main

façade is oriented to the north (Figure 162a) while the back side is pointing south (Figure 162b). Figures 162c and 162d show the cross sections of the building.



Figure 162 – Drawings of the initial state of the Brasov case study; a) north façade; b) south façade; c) longitudinal vertical cross-section; d) transverse vertical cross-section – Source: [159]

On site measurements and tests were carried out to collect the necessary data to assess the strength of the existing building with regards to the structural behaviour [157]. The foundation system is composed of RC continuous beams and membranes above the ground. The superstructure consists of precast RC slabs and walls. The roof is designed as a non-accessible terrace.

The lateral resisting structural system consists of RC walls in both directions. The external walls are made of RC with thickness of 0.4 m with the following composition: mortar on inner and external side, 100 mm of load bearing RC layer on the inner side and 50 mm on the external side, with 120 mm of BCA thermal insulation in between (Figure 164 on the right). The walls are insulated also on the outside with 100 mm of expanded polystyrene provided in a later energy renovation (the structural model considered only the first layer of the external walls).

The layout of the building is shown in Figure 163, representing a typical floor. Thin plasters are used for the finishes, with ordinary paint in the rooms and corridors, and majolica tiles in the sanitary areas; external plasters with marble stone powder with 75% white cement. The interior walls are made of 100 mm thick precast RC panels. The building has a basement with monolithic RC slabs (200 mm) above ground and supported by the foundations. The roof does not include a thermal insulation system. It consists of a RC slab on the inner side (140 mm) and an autoclaved aerated concrete block layer on the outer side (150 mm) with bituminous membrane on top. The building consists of 13 rooms at each floor with a total area of approximately 19 m² per room. There are two access entrances from the outside, one located on the main façade, the other on the side. The entrance to the building is the atrium, with the access door located on the main façade.

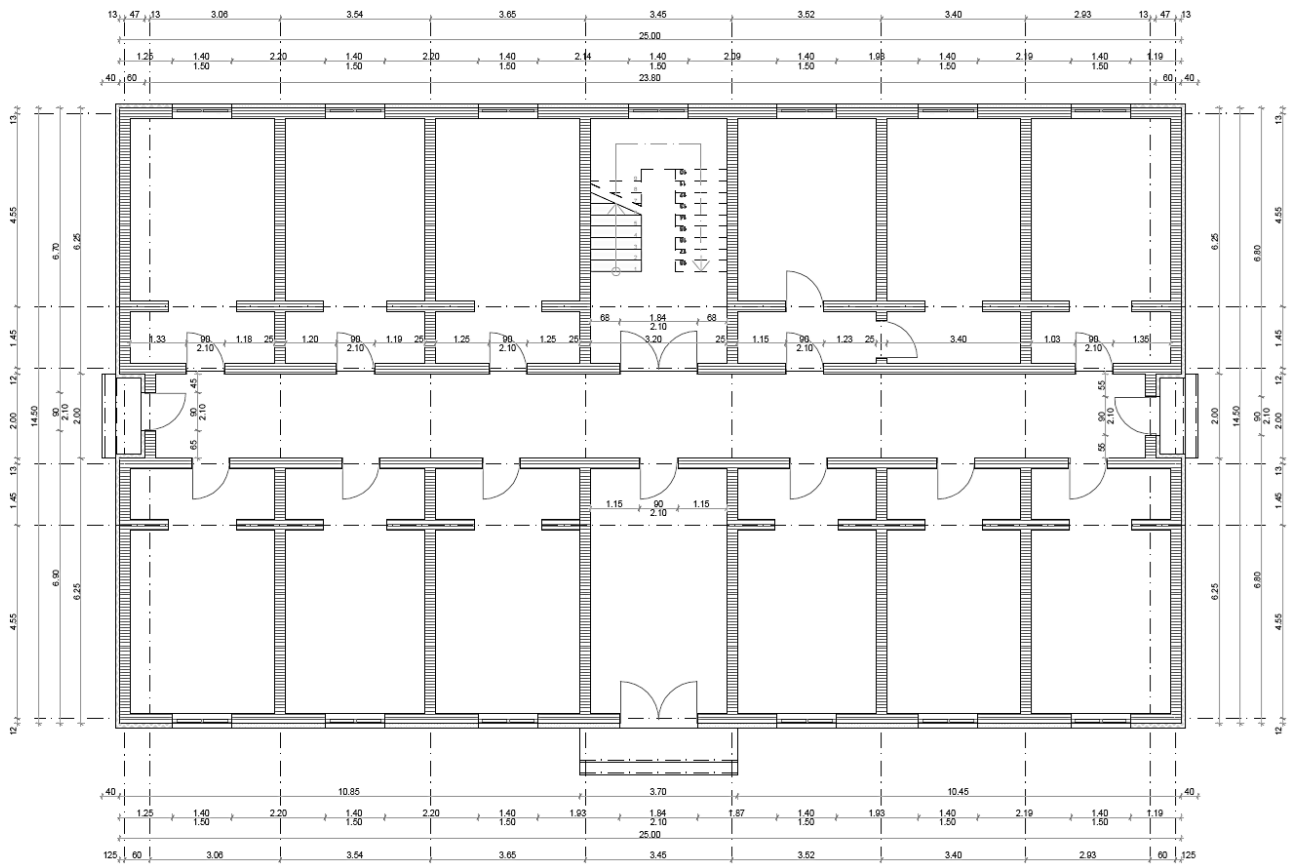
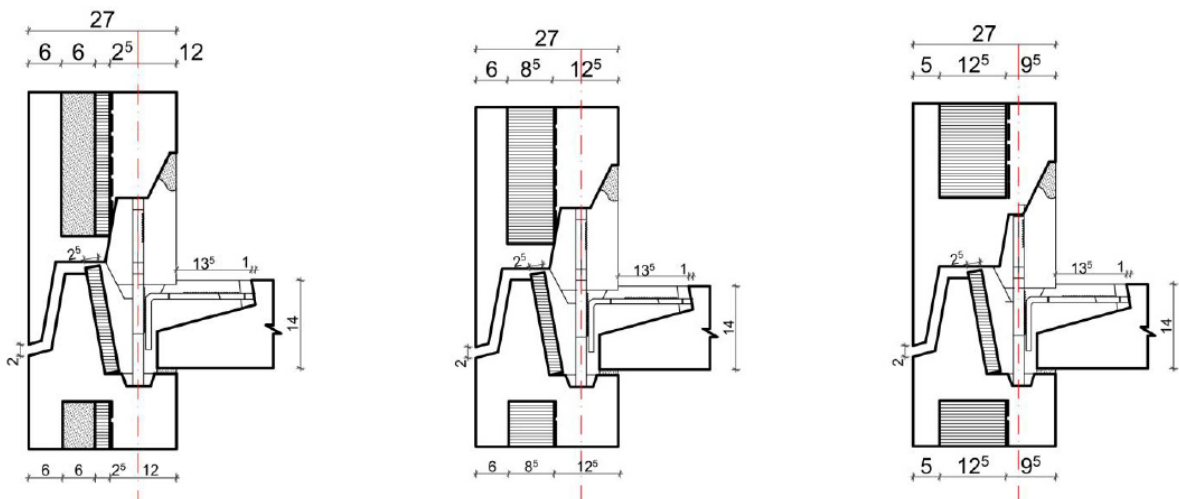

Figure 163 – Typical plan of the Brasov case study – Source: [157]



- | | | |
|---|---|--|
| <p>a. exterior wall: 27 cm thickness (var. Ia)</p> <p>1. structural layer: 12 cm thickness (C16/20)</p> <p>2. vapour barrier: 0.15 cm</p> <p>3. thermal insulation: 6 cm (mineral wool) + 2.5 (polystyrene)</p> <p>4. protection layer: 6 cm (C16/20)</p> | <p>a. exterior wall: 27cm thickness (var. Ib)</p> <p>1. structural layer: 12 cm thickness (C16/20)</p> <p>2. vapour barrier: 0.15 cm</p> <p>3. thermal insulation: 8.4 cm (polystyrene)</p> <p>4. protection layer: 6 cm (C16/20)</p> | <p>a. exterior wall: 27 cm thickness (var. II)</p> <p>1. structural layer: 9.5 cm thickness (C16/20)</p> <p>2. vapour barrier: 0.15 cm</p> <p>3. thermal insulation: 12.5 cm (BCA)</p> <p>4. protection layer: 5 cm (C16/20)</p> |
|---|---|--|

Figure 164 – Prefabricated concrete panels for façade (770-IPCT project); detail from A. Botici et al. reporting the typical connections and stratigraphy of prefabricated RC structure – Source: [160]

5.3.1 Initial state, the RC precast wall structure of Brasov

The following data are taken from the technical reports resulting from the survey conducted by the municipality of Brasov [157]. From the report it was possible to extract information about the initial state of the existing structure. The seismic safety assessment was carried out on the basis of three methods.

- R_1 – qualitative assessment
- R_2 – assessment of the state of degradation
- R_3 – quantitative assessment with calculations

Among the three levels identifying the accuracy of the assessment methodology, the engineers proceeded with the level 2, which implies the use of linear static analysis as the calculation method for R_3 . This choice was made due to the low height of the building, its regularity, and the nature of the structural support system, which is frequently used in Romania [160].

The qualitative assessment (R_1) is based on a list of properties or characteristics of the existing building which are assessed visually or through the results of the survey carried out. The criteria involved are for example the quality of the structural system, quality of concrete and masonry elements, planar or elevation configurations, type of foundations, possible interaction with adjacent buildings, non-structural elements etc., and resulted in 77 points out of 100 (R_1 in Figure 165).

The assessment of the state of degradation (R_2) was conducted through a comprehensive and detailed visual examination indicating that no structural degradation (cracks and others) was observed as a result of various actions during its life (earthquakes, long-term effects, corrosion, etc.). According to the Romanian national standard P100-3/2008, this assessment resulted in 90 points out of 100 (R_2 in Figure 165).

The quantitative assessment (R_3) verified whether the existing structure meets the limit state requirements based on the Romanian national standards [158]. In the level 2 assessment, it relies on force-based design methodologies to obtain the strength capacities. The basic shear force (F_b) was determined on the basis of the linear static analysis as part of the maximum horizontal forces acting at each storey. Then, individually for each separate structural element and for each direction, the indicator R_3 is calculated as the ratio between the capacity of the individual element and the affecting force. Considering the ratio between the sum of the capacities of all the resisting elements and the horizontal forces acting at the ground level, a resulting coefficient of 76% was finally given for this evaluation (R_3 in Figure 165).

Valori ale indicatorului R_1 asociate claselor de risc seismic

Clasa de risc seismic			
I	II	III	IV
$R_1 = 77$			
< 30	30 - 60	61 - 90	91 - 100

Valori ale indicatorului R_2 asociate claselor de risc seismic

Clasa de risc seismic			
I	II	III	IV
$R_2 = 90$			
< 40	40 - 70	71 - 90	91 - 100

Valori ale indicatorului R_3 asociate claselor de risc seismic

Clasa de risc seismic			
I	II	III	IV
$R_3 (\%) = 76$			
< 35	35 - 65	66 - 90	91 - 100

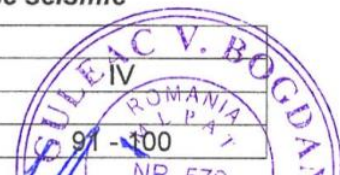

Figure 165 – Seismic risk classification from the technical report provided by the municipality of Brasov – Source: [157]

The vibration modes of the structure have been reported as compliant with the standards, indicating an adequate conformation of the structure. The relative lateral displacements at the ULS and SLS are within the

limits established by the standards. The results obtained from the calculation checks show that the structure under consideration complies with the required conditions in terms of strength and stiffness. In addition, for all concrete walls, the value of the normalised compressive axial force (n) was determined and compared with the permissible value provided by the national code P 100-3/2008, namely $n_{adm} = 0.35$ in the walls. For the total axial forces (N) from the walls, the least favourable condition was considered, where the axial force from indirect effect (N_s) is introduced in the formula $N = N_g \pm N_s$ with the sign (+) to consider the maximum axial stresses. This evaluation resulted in $n_{ef} < n_{adm}$, indicating that walls are not exposed to brittle failures [157].

Considering the indicator values (R) as a measure of expected seismic performance, after the analysis of all the different conditions, the building can be classified in seismic risk class III: “buildings which, under the effect of the earthquake, may have structural degradations that do not significantly affect structural safety, but where non-structural degradations may be significant” [157].

The building was affected by earthquakes in 1977, 1986 and 2004, after which only limited structural degradations occurred. Indicators R1, R2 and R3 show whether, and to what extent, the level of degradation limiting performance, which is essential to meet the basic performance objective (OPB), is guaranteed. In this case, no repair and other consolidation of structural elements belonging to the case study is required to meet the OPB.

A first evaluation was performed within this research to further demonstrate the seismic capabilities of the existing case study in Brasov. Each internal and external wall was modelled with shell layered elements with non-linear behaviour, associated with the materials (steel and concrete). The section considered was 100 mm with an equal reinforcement on both surfaces and assumed as $\phi 8/150$ mm in both directions of the wall development. Therefore, the double stratigraphy outlined by the RC precast panel (Figure 164) was neglected and considered as additional distributed loads for the existing walls. The finite element model of the structure is shown in Figure 166. Each panel was automatically divided in regular shaped meshes. The non-linear behaviour of walls was handled by means of fibres that discretise the sections. The walls were composed of portions of concrete confined at the end, and unconfined concrete depending on the presence of reinforcement bars automatically distributed by the programme. Considering the reinforcement bars, the walls were composed by three layers of fibres.

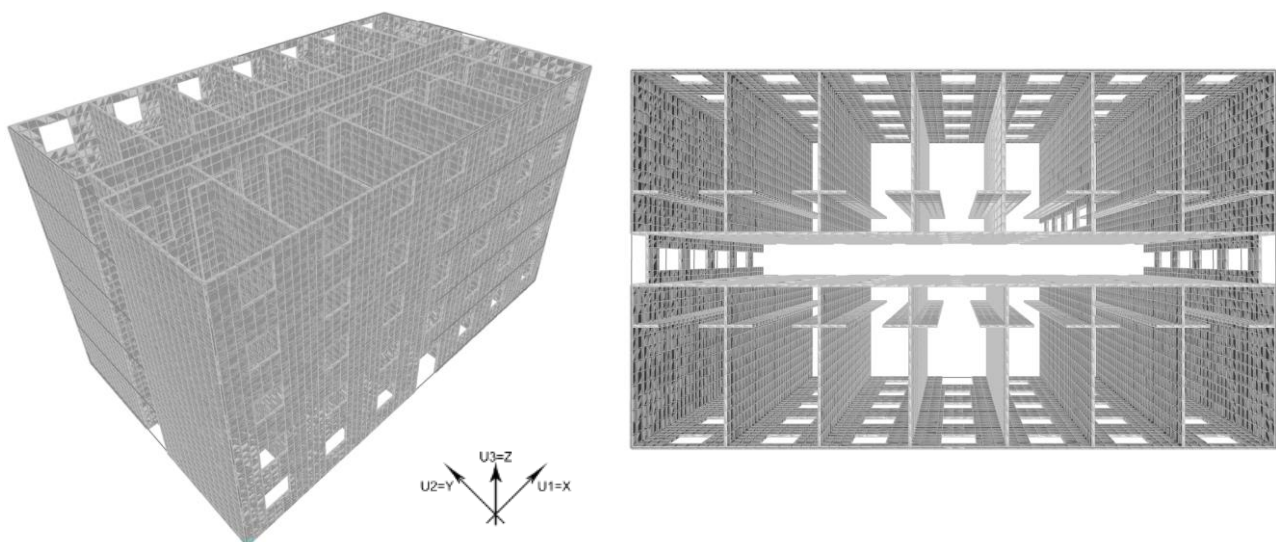

Figure 166 – Panoramic views of the finite element model of the north part of the Athens case study

The capacity curves were obtained from non-linear static analyses performed as in the previous cases, using a uniform load distribution, proportional to the floor masses. The failure of the walls was not explicitly

indicated. However, the global behaviour of the structure was deduced, indicating a strong stiffness and a substantial higher capacity than in the previous cases.

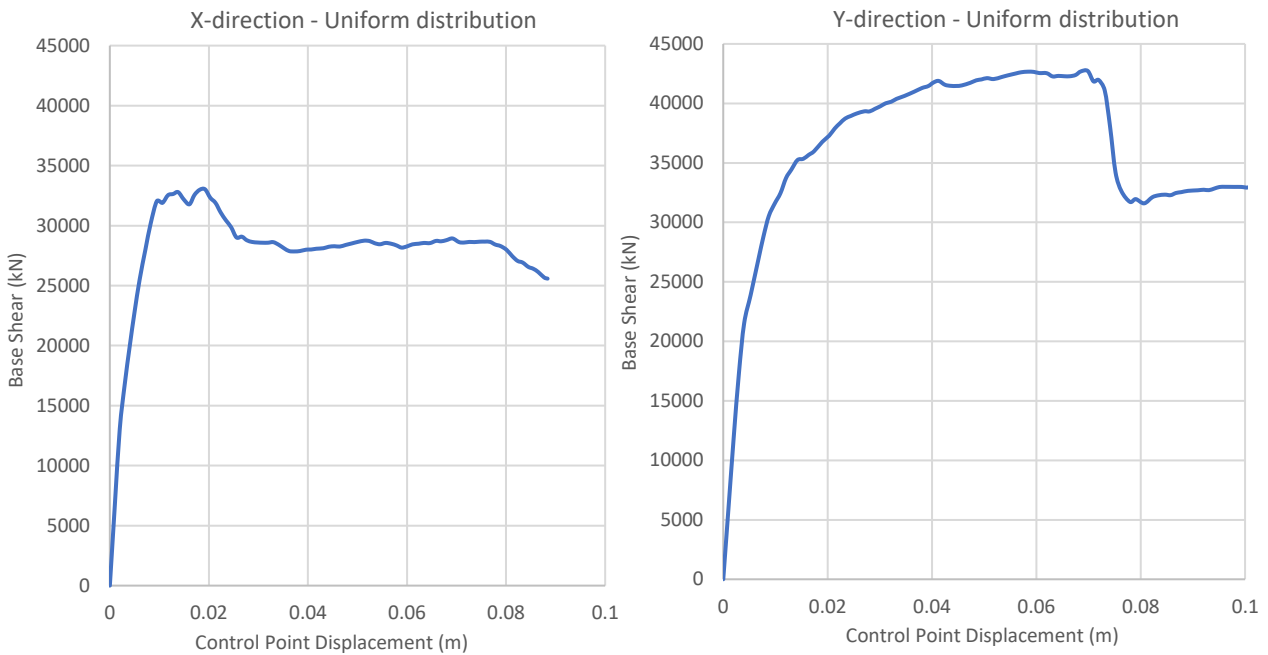

Figure 167 – Capacity curves obtained by pushover analyses with uniform distribution of forces, in both main directions, before and after the application of the steel and aluminium based exoskeletons

As can be seen from the curves, the structure has sufficient capacity to confirm the results of the technical report mentioned above. However, more data should be obtained in order to directly perform a precise assessment on the initial state. Furthermore, the application of a steel exoskeleton on this case study, performed within the Pro-GET-onE [95] research, confirmed the reduced impact of the steel structure due to a significantly lower stiffness compared to the RC precast walls structure [99].

On the other side, a report within Pro-GET-onE [141] highlighted that the energy performance is poor, with reference to winter consumptions and domestic hot water production and that an architectural renovation is required due to the change of use to a social housing block (Table 140).

Table 141 – Estimated annual consumptions from Table 2.5 of the NKUA report – Source: [141]

	Lighting (kWh/y)	Heating (kWh/y)	DHW (kWh/y)	Emissions (kgCO ₂ /y)	Energy label	E_label - Heating	E_label - DWH	E_label- Lighting
Total	13'846.99	99'549.45	91'731.20	43'228.16	C	B	E	A

For this reason, the integrated timber-based system was developed as architectural independent extension for the case study, providing a complete energy renovation of the envelope. A virtual moment-resisting RC structure designed for vertical loads only and with a morphology as close as possible to the Romanian case study (considering some spanning changes due to a different structural system) was then numerically investigated, in combination with the timber-based strengthening system to prove the seismic improvement. All the data related to the RC frames are reported in the next section.

5.3.2 Initial state, a virtual RC moment-resisting frame structure in Brasov

The existing RC moment-resisting frame (MRF) is developed, based on the existing case study of Brasov (presented above), and located in the same area.

5.3.2.1 Materials

Regarding the materials used in the assessment, concrete class C20/25 ($f_{ck,cyl} = 20$ MPa) and steel grade PC52 ($f_{yk} \geq 355$ MPa) were used with reference to the technical assessment report, provided by the municipality of Brasov in the framework of Pro-GET-onE [157].

Table 142 – Mechanical parameters of the concrete class – Source: [157]

Concrete class	Weight ($\frac{kN}{m^3}$)	$f_{ck}(MPa)$	$f_{cd}(MPa) = \frac{0.85 \cdot f_{ck}}{\gamma_c}$	$E(MPa)$	$G(MPa)$	ν
C20/25	25	20	11.33	30'000	12'500	0.2

Table 143 – Mechanical parameters of the steel grade – Source: [157]

Steel grade Rebar	$f_{yk}(MPa)$	$f_u(MPa)$	$f_{yd}(MPa) = \frac{f_{yk}}{\gamma_s}$	$f_{ud}(MPa) = \frac{f_u}{\gamma_s}$	$E(MPa)$	ϵ (%)	ν
PC52	355	355	308.7	308.7	210'000	1	0.3

- f_{ck} - characteristic compressive strength of concrete
- f_{cd} - design compressive strength of concrete
- γ_c - partial factor for concrete, used for the linear dynamic analyses
- E - modulus of elasticity
- G - shear modulus
- ν - Poisson coefficient
- f_{yk} - characteristic value of yield strength of steel
- f_u - characteristic value of ultimate strength of steel
- γ_s - partial factor for reinforcement steel, used for the linear dynamic analyses
- f_{yd} - design value of yield strength of steel
- f_{ud} - design value of ultimate strength of steel

5.3.2.2 Structural scheme and characterisation of the members

The structure consists of five floors, each of 2.6 m height, with a total plan size of 28x15 m, measured from the barycentric axes of the frames. The horizontal structures are made of 120 mm thick concrete slabs that can be considered as diaphragm constraints, transferring the vertical loads in both main directions. The beams have different heights depending on the spans, and a width that corresponds to the side of the columns. These vertical elements are 350x350 mm at the ground floor and 300x300 mm for the remaining storeys. The spans between columns follow the morphology of the reference Brasov structure, but adapt the dimensions to the different structural system. Along the longitudinal direction (X) the frame presents 7 spans of 4 m, while in the transversal direction (Y) two spans of 6 m are interrupted by a single 3 m span (Figure 168). The dimensions of the structural elements and the amount of reinforcement are designed based exclusively on vertical loads, with the stresses deriving from the ultimate limit state combination as defined by the Eurocodes [133, 135]. The cross-sectional dimension of the structural elements together with the reinforcement content are indicated in Table 144. The planimetric distribution of the Brasov case study has been followed, placing high RC beams where the partition walls continue below. A three-dimensional model was created to carry out the seismic analyses (Figures 168a and 168b).

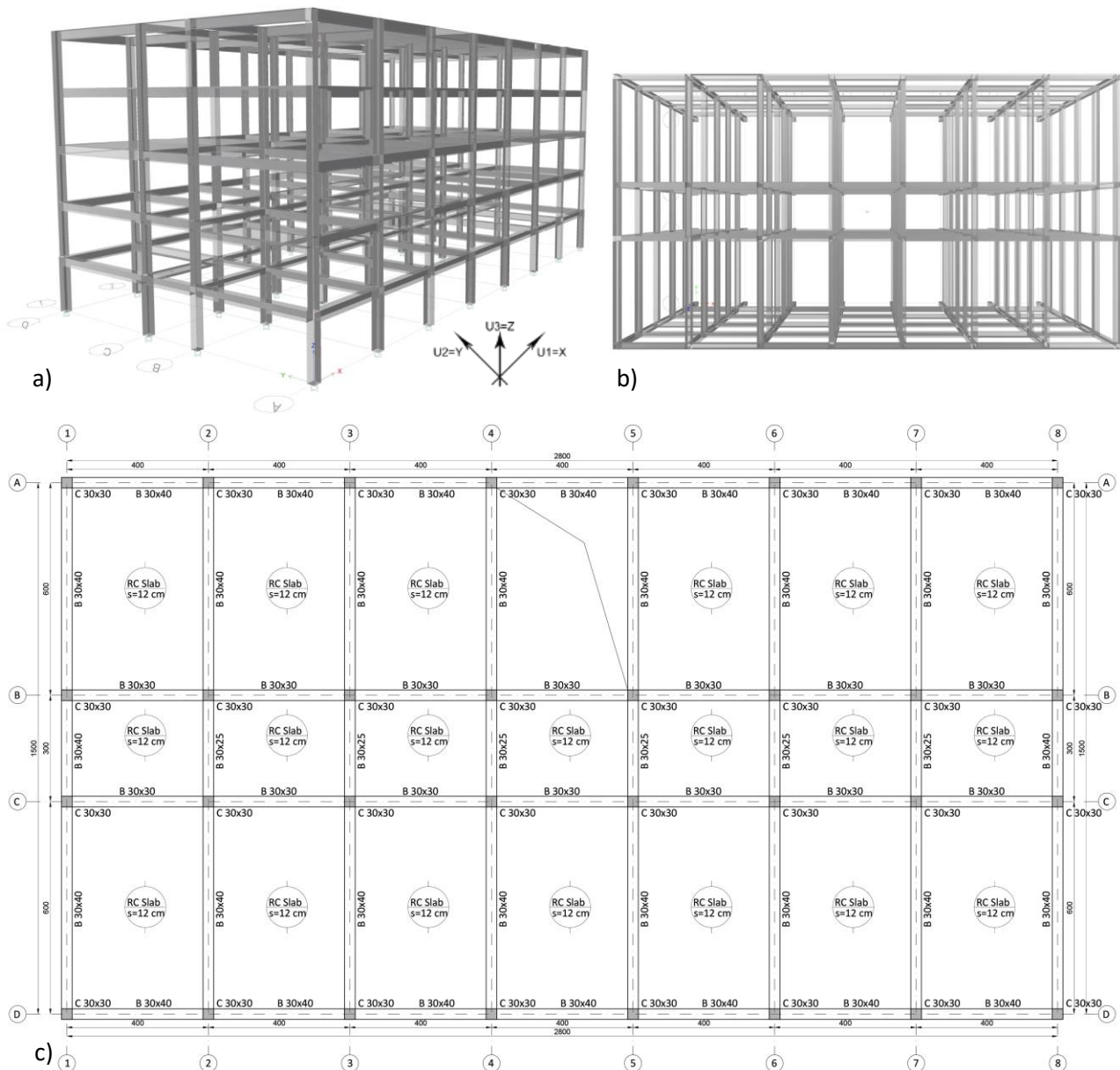

Figure 168 – a) and b) Panoramic views of the finite element model of the initial state of the RC MRF; c) typical horizontal cross section of the MRF. Due to the symmetry of the structure only half of the planimetry is shown. Cross-sectional dimensions of beams (B) and columns (C) are indicated in cm together with spans

Table 144 - Cross-sectional dimensions of beams (B) and columns (C) are indicated in the table together with the relative reinforcement content and spanning lengths

Cross-section	Span	Long. Rebar		Trans. Rebar
		Top	Bottom	Φ/step (mm)
mm	m			
C 350x350	2.6	3Φ18	3Φ18	Φ8/200
C 300x300	2.6	2Φ18	2Φ18	Φ8/200
B 350x400	4	3Φ14	3Φ14	Φ8/200
B 350x400	6	2Φ18 1Φ14	3Φ14	Φ8/200
B 350x250	3	3Φ14	3Φ14	Φ8/200
B 350x300	4	3Φ14	3Φ14	Φ8/200
B 300x400	4	3Φ14	3Φ14	Φ8/200
B 300x400	6	2Φ18 1Φ14	3Φ14	Φ8/200

B 300x250	3	2Φ14	2Φ14	Φ8/200
B 300x300	4	3Φ14	2Φ14	Φ8/200

5.3.2.3 Modelling parameters

A numerical model was developed with the finite element software ETABS [130], for the existing RC structure alone (initial state) and for the combined solution with the CLT external structure (project state). Through linear dynamic (modal response spectrum) and non-linear static (pushover) analyses, it was subsequently possible to assess the seismic improvement.

Load patterns

The stratigraphy of the floors is defined and listed below from intrados to extrados.

- Roof: 15 mm plaster (0.3 kN/m²), 120 mm RC slab (3 kN/m²), an average of 135 mm lightweight screed (1.35 kN/m²), and 5 mm perlite/bitumen membrane (0.045 kN/m²).
- Type floors: 15 mm plaster (0.3 kN/m²), 120 mm RC slab (3 kN/m²), 40 mm lightweight screed (0.4 kN/m²), and 20 mm ceramic pavement (0.23 kN/m²).

The following tables show the loads considered in the model (Tables 145 and 146). The categories selected for imposed and snow loads refer to the Eurocode 1 [134, 135]. *A* indicates the areas for domestic and residential activities, while *H* represents the roof-areas accessible for maintenance.

Table 145 – Load patterns assigned to the floors of the storeys – Source: [134, 135]

	Floors		
	Self-weight	Dead load	Live load
Roof	3 kN/m ²	1.69 kN/m ²	$H = 0.4 \text{ kN/m}^2$; $Snow = 2 \text{ kN/m}^2$
Type floor	3 kN/m ²	0.93 kN/m ²	$A = 2 \text{ kN/m}^2$
Stairwell	3 kN/m ²	0.93 kN/m ²	$A = 4 \text{ kN/m}^2$

Partition walls have been considered all along the perimeter as external walls and within every storey following the subdivision of the Brasov case study and creating single rooms in every sector divided by the RC beams. Linear distributed loads were applied on the beams as specified in Table 146.

Table 146 – Load patterns of the partition-walls

	Walls		
	Self-weight	Dead load	Live load
External partition with openings	–	4.7 kN/m	–
Internal partition	–	2.8 kN/m	–

Definition of the mass source and seismic load combinations

The definition of combination of loads and masses to be used for seismic analysis is based on the Eurocodes 0 [136] and 8 [12] respectively. All used coefficients and combinations factors are reported in Table 30 in Section 5.1.1.3, and (5.1) represent the equation for the definition of the masses.

Following the definition of the model and masses, the natural vibration modes of the structure are determined with an eigenvalue analysis, dynamically characterising the response of the structure. By applying the design response spectra to each vibration mode, the maximum values of stresses and displacements are then determined and finally combined, using the principle of superposition of effects. As linear analyses, the energy dissipation during the earthquake is considered through the introduction of the *q*-factor (behaviour factor) which leads to a reduction of the horizontal actions resulting from the elastic

response spectrum (design response spectrum). A reference elastic response spectrum is determined for the performance level of significant damage (LS SD) as defined in the Eurocode 8 – Part 3 [11]. The q-factor is calculated from the results of the non-linear static analysis (pushover) and represents the progressive damage of the RC elements. Non-linear static analyses are carried out with reference to Eurocode 8 [12], considering two horizontal force distributions: a "uniform" pattern, with lateral forces proportional to the masses regardless of elevation, and a "modal" pattern, proportional to the lateral forces deriving from the vibration modes.

With difference to the previous case studies, the seismic vulnerability will be mainly assessed through a displacement design method with the use of the TDVs. The linear dynamic analysis was performed in order to verify the inter-storey drifts and to verify the timber-based exoskeleton in the next section. Since major importance is given to the non-linear static analysis, more combinations than required by the standards, were performed, considering two lateral force distributions, two directions and two signs of horizontal load application, resulting in eight analyses for each model. Therefore, the following analyses have been performed.

- ULS: Ultimate limit states
- SLS: Serviceability limit states
- QP: Quasi-permanent vertical loads combination
- LS SD [+QP]: SD Response spectrum modal analysis in combination with QP
- GRAV: Non-linear static vertical loads based on the QP combination
- PUSH_X: Non-linear static horizontal loads – uniform pattern acting along the longitudinal direction
- PUSH_Y: Non-linear static horizontal loads – uniform pattern acting along the transverse direction
- -PUSH_X: Non-linear static horizontal loads – uniform pattern acting along the longitudinal direction
- -PUSH_Y: Non-linear static horizontal loads – uniform pattern acting along the transverse direction
- PUSH_X Mode: Non-linear static horizontal loads – modal pattern based on the vibration mode acting in longitudinal direction
- PUSH_Y Mode: Non-linear static horizontal loads – modal pattern based on the vibration mode acting in transverse direction
- -PUSH_X Mode: Non-linear static horizontal loads – modal pattern based on the vibration mode acting in longitudinal direction
- -PUSH_Y Mode: Non-linear static horizontal loads – modal pattern based on the vibration mode acting in transverse direction

Restraints/Constraints/Cracking

Fixed joints, involving all six degrees of freedom, were introduced at the foundation level as external restrains, while diaphragm semi-rigid constraints were introduced for all the joints belonging to the floor levels due to the presence of 120 mm thick RC slabs. The latter were defined as RC membranes of 120 mm.

Cracking phenomena were considered only for the linear dynamic analysis, by introducing reduced effective shear and bending stiffnesses for the structural elements, considering property modifiers reducing beam and column shear and bending stiffnesses of 40%, as indicated in the Eurocodes for RC members [12]. In particular, the bending stiffness (M3) and the shear stiffness (V2) of the beams are multiplied by 0.6, and for RC columns the same reduction is provided to bending (M2 and M3) and shear stiffness (V2 and V3) along both main directions (Table 147).

Table 147 – Effective stiffness values considering cracking only in the linear dynamic analysis – Source: [12]

Component	Bending Stiffness	Shear Stiffness
Beams	$0.6 E_c I_g$	$0.6 E_c A_w$
Columns	$0.6 E_c I_g$	$0.6 E_c A_w$

In non-linear analysis the cracking phenomena was not considered in order to fully represent the non-linear behaviour of the resisting sections.

Response spectrum functions and q-factors

A type 1 elastic response spectrum on ground type A was matched (Figure 169) with the use of the database provided in [13], characterised by a peak ground acceleration of 0.2 g with a return period of 475 years ($P_r = 10\%$ in 50 years), and then increased with respect to the soil factor B as indicated in the available technical report [157].

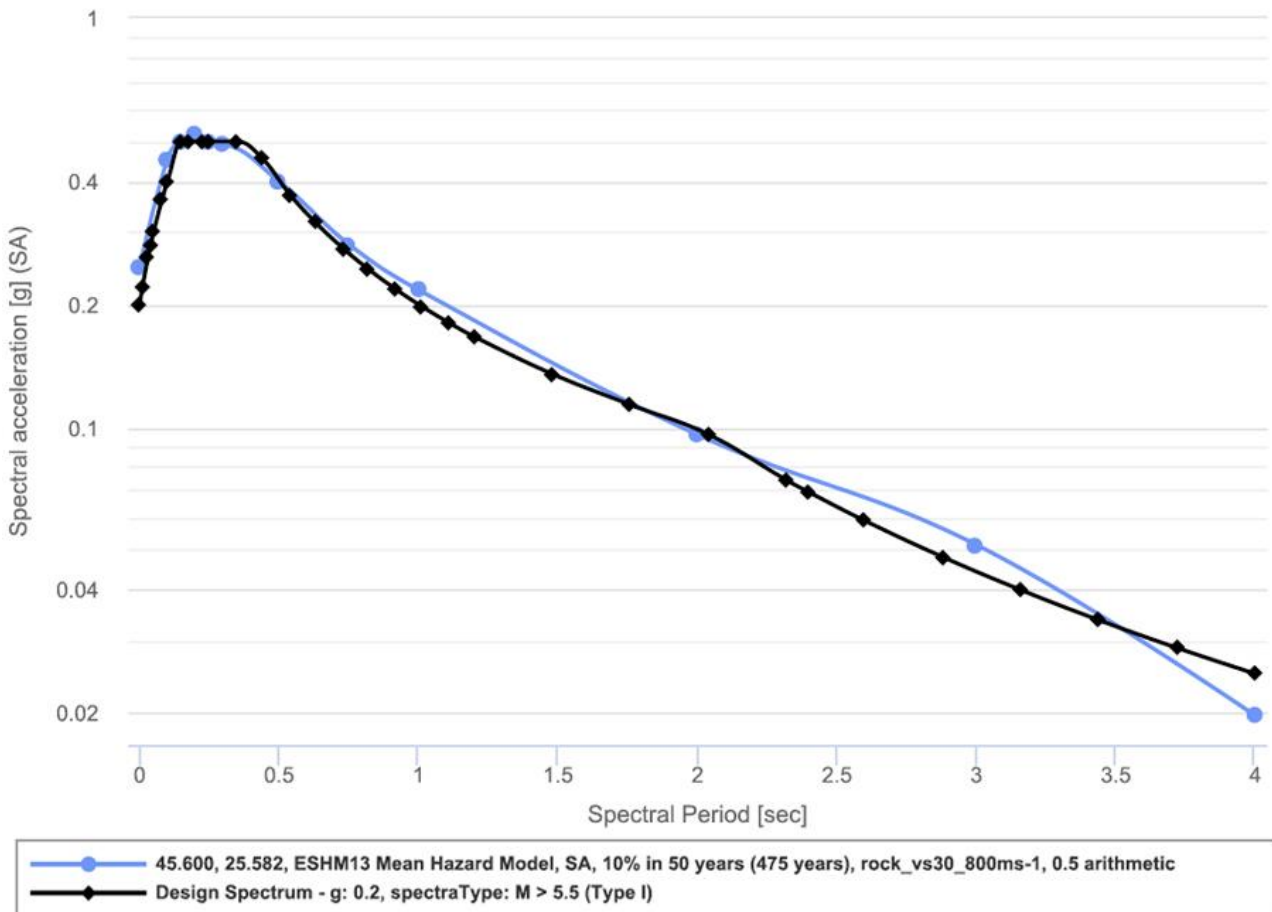

Figure 169 – Registered elastic response spectrum of Brasov (45.600-25.582) with matching EC8 spectrum www.efehr.org/Documentation/licenses-copyright – Source: [12, 13]

Table 148 – Seismic parameters for the definition of the elastic response spectra – Source: [12, 13]

Spectrum type 1 – Ground type B – EC8	$\gamma_I = 1$
LS SD – $P_{VR} = 10\%$; $T_R = 475$ years; $V_R = 50$ years	$a_g \cdot \gamma_I = 0.2 g$

For linear dynamic analyses the design response spectrum for LS SD is calculated by dividing the ordinates of the elastic response spectrum by the q-factor. The latter is defined for this case study, following the approach presented in [52]. With reference to Figure 170, the following values are obtained from the pushover analyses based on the maximum displacement set to the LS SD (formation of the first plastic hinges beyond the limit state of significant damage).

- R_μ - ductility reduction factor, defined as the ratio of the elastic design force (V_e) to the yield strength level (V_y), reflecting the energy dissipation capacity of the system and coinciding with the ductility

(μ) measured as the ratio of the displacement capacity (Δ_{max}) at the LS SD to the displacement linked to the yield point and the idealised elastic-perfectly plastic response curve (Δ_y) [52].

- R_s – the overstrength factor, defined as the idealised structural yield level (V_y) and the first actual significant yield level (V_s), corresponding to the first hinge beyond the LS DL (similar to what defined by standards), representing the reserve strength that exists between the two points [52].

The behaviour factor (q) is finally evaluated as product between the ductility reduction factor (R_μ) and the overstrength factor (R_s) (5.44).

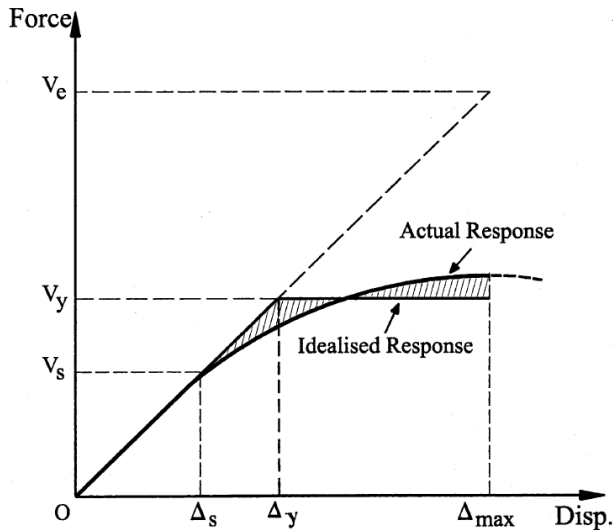

$$q = R_\mu \cdot R_s \quad (5.44)$$

with

- $R_\mu = \frac{V_e}{V_y}$
- $R_s = \frac{V_y}{V_s}$

Figure 170 – Parameters used for the calculation of ductility, overstrength and performance factor – Source: [52]

The minimum q -factors were selected among the analyses performed in both directions. On the basis of the elastic response spectrum different design spectra were defined, differentiated by directions as reported in Table 149.

Table 149 – Ductility reduction factors, overstrength factors and q -factors obtained for all the pushover analyses

LS SD – Initial State	R_μ	R_s	q -factor
PUSH_X	1.86	1.66	3.08
-PUSH_X	1.84	1.74	3.19
PUSH_X M	1.75	1.81	3.17
-PUSH_X M	1.70	1.71	2.90
PUSH_Y	1.67	1.63	2.72
-PUSH_Y	1.63	1.64	2.67
PUSH_Y M	1.61	1.78	2.88
-PUSH_Y M	1.61	1.78	2.88
Pushover analyses in longitudinal direction (X)			2.90
Pushover analyses in transverse direction (Y)			2.67
Verification for brittle failures			1.50

Plastic hinges

In order to perform the static non-linear analysis, the non-linear behaviour of all resistant elements involved in the analyses was defined. RC beams and columns were modelled as nonlinear frame elements with lumped plasticity by defining plastic hinges at both ends of the elements. The hinge properties follow the formulas reported in the Annex A of the Eurocode 8-Part 3 [11] for ductile mechanisms, identifying the performance levels for each step of the non-linear static analysis (5.4), (5.5) and (5.6) in Section 5.1.1.3. The behaviour of these hinges is depending on the cross-section of the element, the material properties, the longitudinal and

transversal steel reinforcements, and the axial loads calculated with a QP-combination of vertical loads. As SAP2000, ETABS [130] provides default-hinge properties. PMM (combined bending and axial loads) hinges for columns and M3 (only bending loads) hinges for beams were assigned. In particular, fibre non-linear hinges were inserted to the ends of the columns. They consider a discretisation of the sections by placing reinforcement and concrete surfaces in the corresponding position and assigning to each fibre the relative stress-strain relationship. During the steps of the non-linear analyses, the hinges record progressive losses of the section as a function of the non-linear behaviour of the materials and ultimately also the limit state transition for structural sections. In order to take into account brittle failures on the same elements, force-controlled hinges were placed in the middle of each column and at the ends of each beam (V2 for beams and V2-V3 for columns). The shear strength, which is the maximum allowable force for these hinges, is calculated with reference to the paragraph 6.2.3 of Eurocode 2 [133] with (5.7), (5.8) and (5.9) from Section 5.1.1.3.

Displacement controlled non-linear hinges were placed at the ends of existing beams and columns.

- M3 for beams – Bending failure condition
- Fibre P-M2-M3 for columns – Combined axial and bending failure condition (axial loads from QP)

Force controlled plastic hinges were placed in the ends of the beams and in the middle of each column

- V2 for beams – Shear force failure
- V2-V3 for columns – Shear force failure

5.3.2.4 Results

Modal analysis

The evaluation of the dynamic behaviour of the building is carried out by means of a modal analysis performed on the structural model. The analysis is carried out considering the first 12 vibration modes (modal masses greater than 5%) and checking that the total mass activated by the modes is greater than 85%. The following are the results of the first four vibration modes (Table 150).

Table 150 – Results of the modal analysis of the initial state of the Brasov MRF; periods are expressed in seconds while participating masses are percentages of the total mass of the building

Mode	Period (s)	Initial State		
		U1	U2	RZ
1	1.138	0	79.1%	0
2	1.061	79.6%	0	≈ 0
3	0.976	≈ 0	0	79.64%
4	0.364	0	11.1%	0

The participating masses (Table 150) and the modal displacements (Figure 171) show that the dynamic behaviour of the structure is substantially regular, the first two vibration modes act along the main two directions, while the third is torsional. The periods of the structure are relatively high due to the stiffness reduction of the structural elements (present only in the linear analyses) and the small dimensions of the column cross-sections.

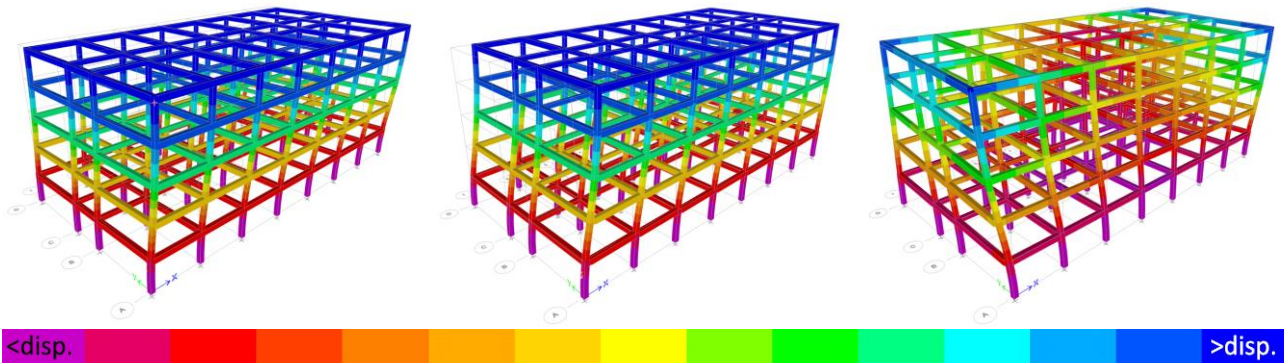

Figure 171 – Representation of the first three main vibration modes in ascending order from left to right; the displacements increase from purple to blue

Linear dynamic analysis

With the displacements obtained through the linear dynamic analysis, it was possible to check the interstorey drift (d_r) before and after the application of the timber strengthening solution for both the main directions, following 4.4.3.2 of [12], using the equation for buildings which consider non-structural elements of brittle materials attached to the structure (5.45) and verifying the horizontal displacement deriving from the LS SD increased by the q-factor as required by the standards (5.46).

$$d_r \nu \leq 0.005h \tag{5.45}$$

with

- d_r - is the design interstorey drift, evaluated as the difference of the average lateral displacement d , at the top and bottom of the storey under consideration and calculated as $d_r = q d_{r,LS SD}$;
- h - is the storey height;
- ν - is the reduction factor which considers the lower return period of the seismic action associated with the damage limitation requirement. It is set to 0.5 for importance classes I and II.

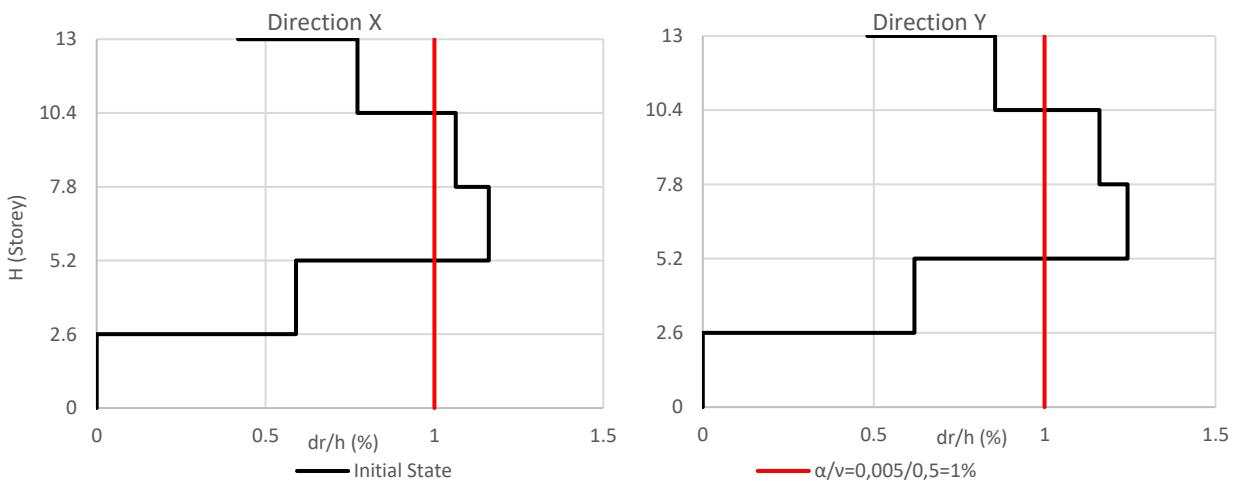

Figure 172 – Interstorey drift verification for the initial state of the Brasov MRF for both main directions as defined in [12]; the displacement of each storey is calculated from the centres of masses (CM)

The assessment shown in Figure 172 is quantified in a seismic vulnerability to frequent earthquakes (LS DL) of 80% considering the transverse direction (Y), and 86% along the longitudinal one (X).

$$E(a_g)_{LS DL} = 80\%$$

Non-linear static analysis (pushover)

A force controlled static non-linear analysis based on the quasi-permanent vertical load combination (GRAV) is starting point for the displacement-control pushover analyses. These were performed, as required by the standards [12], in both directions, with positive and negative signs and using two different lateral load distributions: proportional to mass regardless of elevation and proportional to the lateral forces associated to the main vibration modes. As results, capacity curves associating the total base shear acting at each loading step with the displacement of the control point, situated in the roof, are derived for the multi degree of freedom (MDOF) model.

- By using the target displacement verification (TDV) as defined in Annex B of [12], the displacement capacity is evaluated for which the performance level of significant damage limit state was exceeded for the elements of the existing RC structure. The target displacement is found with the scaled capacity curves representing the equivalent single degree of freedom (SDOF) system and the elastic response spectrum of the site for the LS-SD. Figures 173 to 176 represent the TDVs for the eight pushover analyses performed for the initial state of the Brasov MRF. The displacement capacities were compared to the demand values (C/D in Table 151), identifying the seismic vulnerability at the LS SD.
- Eventually, the stiffness values ($K_{LS DL}$) are obtained as the ratio between horizontal force and displacement corresponding to the step of the analysis which sees the formation of the first plastic hinge beyond the damage limitation performance level (beyond the elastic limit), which represents the slope of the initial part (linear behaviour) of the correlated perfectly plastic elastic system.

$$K_{LS DL} = \frac{F_{LS DL}}{d_{(F_{FS DL})}} \tag{5.46}$$

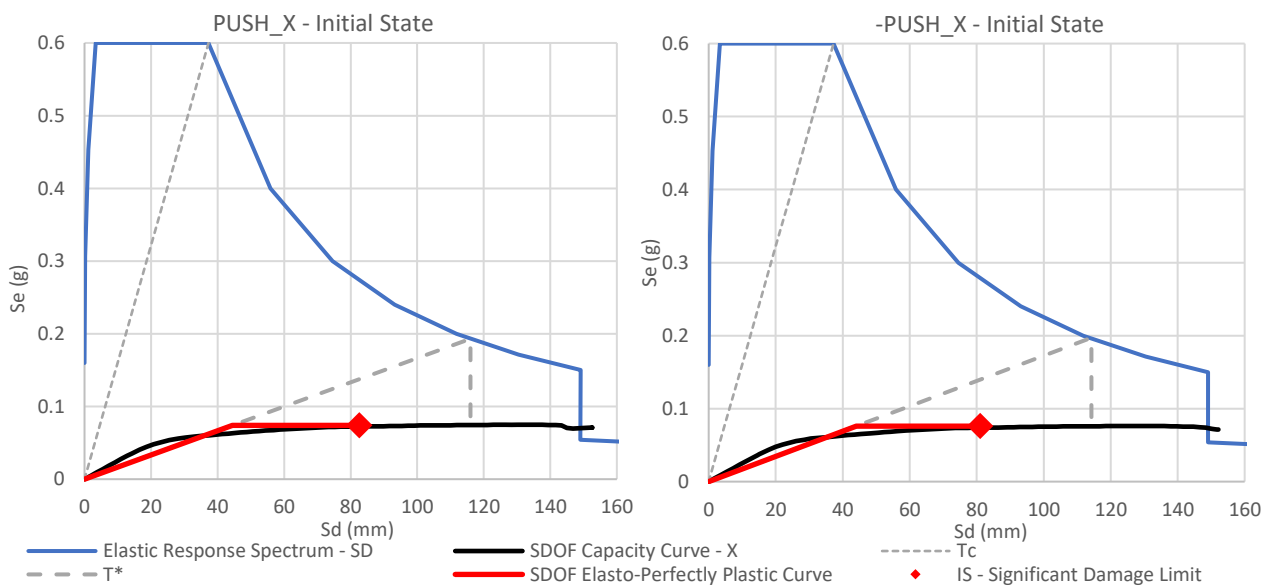

Figure 173 – Pseudo-acceleration and displacement elastic response spectrum (0.2 g), SDOF capacity curves with relative elasto-perfectly plastic curves and indicating displacement capacities; through T^* and the elastic response spectrum the demanded displacements are also graphically identified; uniform distribution along X-direction

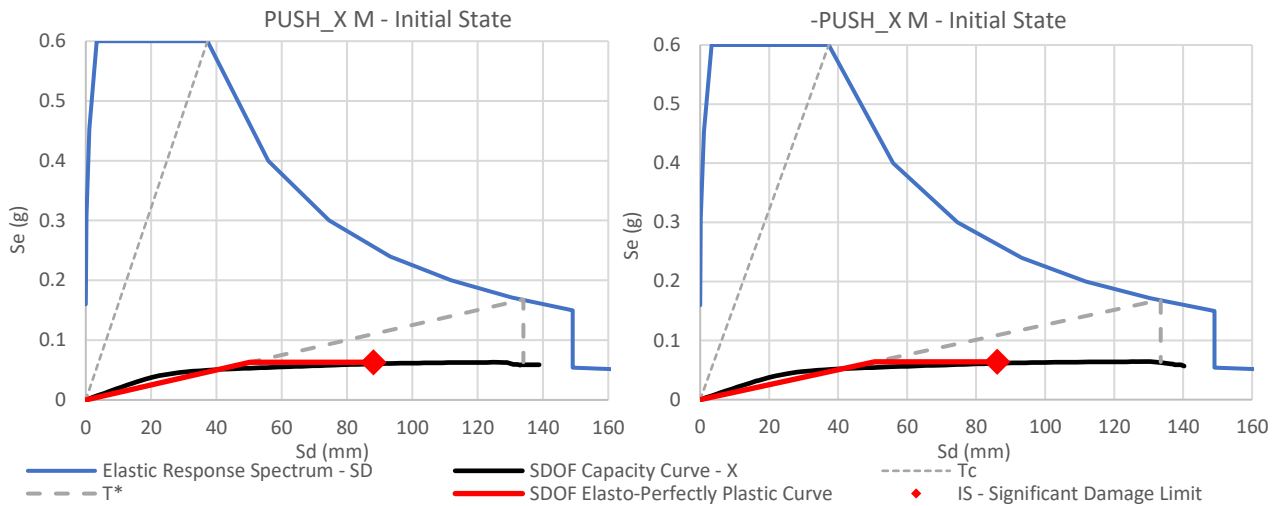

Figure 174 – Pseudo-acceleration and displacement elastic response spectrum (0.2 g), SDOF capacity curves with relative elasto-perfectly plastic curves and indicating displacement capacities; through T^* and the elastic response spectrum the demanded displacements are also graphically identified; modal distribution along X-direction

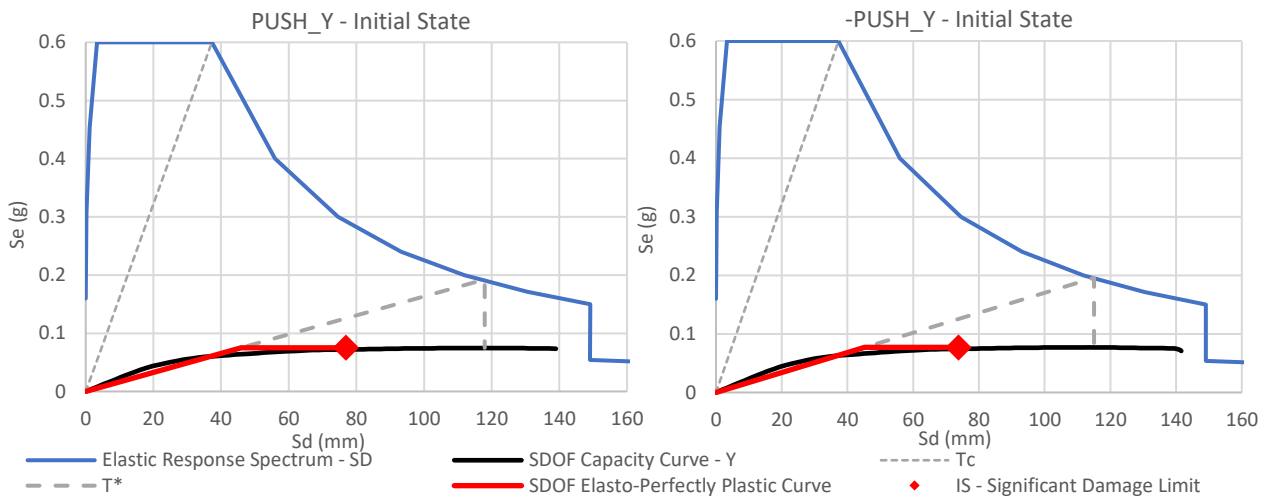

Figure 175 – Pseudo-acceleration and displacement elastic response spectrum (0.2 g), SDOF capacity curves with relative elasto-perfectly plastic curves and indicating displacement capacities; through T^* and the elastic response spectrum the demanded displacements are also graphically identified; uniform distribution along Y-direction

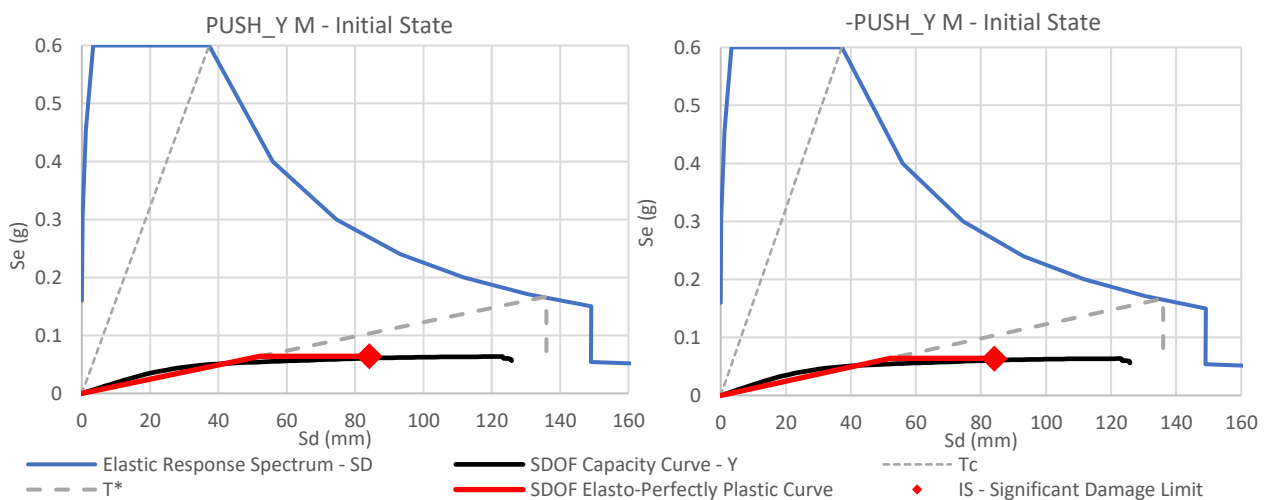

Figure 176 – Pseudo-acceleration and displacement elastic response spectrum (0.2 g), SDOF capacity curves with relative elasto-perfectly plastic curves and indicating displacement capacities; through T^* and the elastic response spectrum the demanded displacements are also graphically identified; modal distribution along Y-direction

Table 151 – Target displacement verification (TDV) for the significant damage performance level (LS SD), $T_R = 475$ years, $PV = 10\%$ in 50 years; capacities and demands are expressed in mm of the control points and related base shear values (kN) for the analyses that regard the initial state; the letter M indicates the analyses done with lateral load distribution proportional to the main vibration modes

Analysis	Capacity Shear (kN)	Demand Shear (kN)	Capacity Displ. (mm)	Demand Displ. (mm)	TDV – C/D (%)	$K_{LS DL}$ (kN/m)
PUSH_X	2'185	2'262	90.1	126.6	71	65'328
-PUSH_X	2'228	2'307	88.4	124.6	71	66'395
PUSH_X M	1'773	1'903	96.7	147.1	66	51'223
-PUSH_X M	1'778	1'894	99.4	146.5	68	50'818
PUSH_Y	2'181	2'275	89.2	136.9	65	54'859
-PUSH_Y	2'255	2'352	85.7	133.5	64	56'469
PUSH_Y M	1'778	2'045	99.4	160.7	62	42'903
-PUSH_Y M	1'774	2'015	98.7	159.3	62	42'904

Considering the elastic response spectrum introduced above, it was possible to evaluate the C/D ratio for all the combinations evaluated (Table 151), obtaining a reference value for seismic vulnerability at the LS SD that correspond to 62% in transverse direction (Y) and to 66% in longitudinal direction (X).

5.3.3 Project state, application of the timber exoskeleton

From the LCA it is calculated that over a 50-year analysis period, out of a total of approximately 700 tonnes of CO_{2e} related to the whole renovation, 35% is due to the external steel structure (Section 4.4). To further address climate change mitigation and minimise the environmental impact, an alternative structural solution is investigated in this section. In accordance with the philosophy of the EU project, it was necessary to develop a timber-based exoskeleton that constitutes an integrated system capable of meeting all the three main objectives (seismic safety, energetic improvement, and additional space). By means of high-performance façades or external extensions, prefabricated timber components can be easily installed with effective practical results (Section 3.3). As introduced in Section 4.3 the engineered wood products such as cross-laminated timber (CLT) panels are produced with a high degree of prefabrication, allowing for efficient and safe on-site installation, and have been applied globally in many low- and mid-rise buildings. Under seismic loads, CLT shear walls with properly designed connection systems are able to provide adequate lateral capacity for multi-storey buildings. The high level of lateral in-plane strength and stiffness, together with the lightness of the material, make it an easily applicable product for extensions or renovations of existing buildings.

The integrated wood-based system presented here to achieve a seismic improvement on the MRF structure is intended to be considered for the Brasov case study as an independent architectural extension, providing a complete energy renovation of the envelope as well as tailored residential units for the inhabitants. Therefore, the system here connected to the existing structure is, in fact, designed and verified also as an independent extension, providing a seismic joint between the structures. The technological solution is presented in Section 7.2 as an alternative to the one foreseen for the steel exoskeleton.

5.3.3.1 Materials

Wood does not behave as a continuous material due to its nature and is therefore dependent on the direction of loads and grain in the structural elements. The mechanical properties of CLT elements depend directly on the material used for the boards. Three elastic moduli, three shear moduli and six transverse deformation coefficients are usually required to describe a volumetric model correctly. However, in practice the analysis concerning the cross-sections of the panels require a reduced amount of information. Considering the XY

plane two elastic moduli and three shear moduli are defined for wooden structural elements (Figure 177) [161].

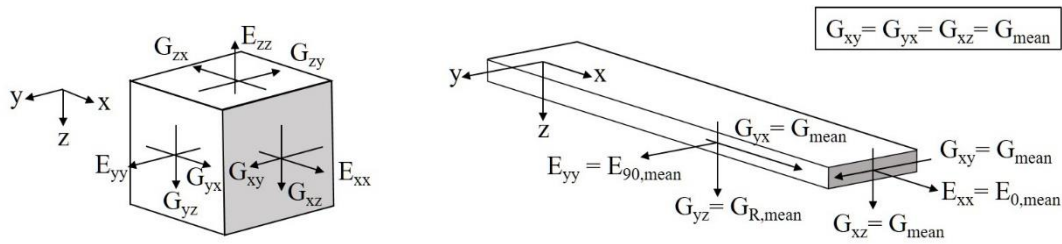

Figure 177 – Young’s moduli and shear moduli for a volume and a board – Source: [161]

Referring to Figure 177, E_{90} and E_0 denote the modulus of elasticity perpendicular and parallel to the grain respectively; G_{xy} , G_{yx} and G_{xz} can be associated with G_{mean} from Table 152, while G_{yz} represents the rolling shear $G_{R,mean}$, usually taken as 10% of the G_{mean} [161].

In order to consider the behaviour of wood and implement CLT panels within the software, a custom orthotropic material was created with mechanical properties directly related to the components considered in the model. The walls and slabs of the exoskeleton are made of CLT panels made out of birch [162] and spruce, respectively. The strength values of the CLT wood used in the model are summarised in Table 152.

Table 152 – Characteristic strength and stiffness properties in MPa for CLT-Spruce (ETA-06/0009, [163]) and CLT-Birch [162], plus relative mean density values in kg/m³

CLT	$f_{m,CLT,k}$ (MPa)	$f_{c,0,CLT,k}$ (MPa)	$f_{c,90,CLT,k}$ (MPa)	$f_{t,0,CLT,k}$ (MPa)	$E_{0,CLT,mean}$ (MPa)	$E_{90,CLT,mean}$ (MPa)	$G_{CLT,mean}$ (MPa)	$\rho_{CLT,mean}$ (kg/m ³)
Spruce (C24)	24	21	2.5	14	12'000	370	690	470
Birch	38	38	5.0	28.5	15'000	650	710	620

- $f_{m,CLT,k}$ - bending strength
- $f_{c,0,CLT,k}$ - compressive strength parallel to grain
- $f_{c,90,CLT,k}$ - compressive strength perpendicular to grain
- $f_{t,0,CLT,k}$ - tensile strength parallel to grain
- $E_{0,CLT,mean}$ - mean modulus of elasticity parallel to grain
- $E_{90,CLT,mean}$ - mean modulus of elasticity perpendicular to grain
- $G_{CLT,mean}$ - mean shear modulus ($G_{R,mean}$ is defined as 10% of this value)
- $\rho_{CLT,mean}$ - mean density

Two orthotropic materials (for spruce and birch) were defined through the insertion of the values E1, E2, G12, G13 and G23 with reference to E_0 , E_{90} , G_{mean} and $G_{R,mean}$ respectively.

Since CLT panels are composed of wooden boards glued perpendicularly to each other in several layers, the structural panels were implemented using shell-layered elements provided by the software [129, 130]. These elements are divided by layers that can be characterised by the different orientation of each layer (crossed layers) and the assignment of the corresponding custom orthotropic materials. Numerical tests to confirm the possibility of using these elements have been performed and exposed in Section 5.3.3.4.

5.3.3.2 Structural scheme and characterisation of the members

CLT walls constitute the structural strengthening system for the existing structure and are externally added in continuity of the RC frames, in the plane perpendicular to the external façades (Figure 178b). They improve the seismic performance by increasing the global stiffness of the system, reduce the displacement demand, and enhance the capacity by avoiding concentration of damages in the lower levels [113].

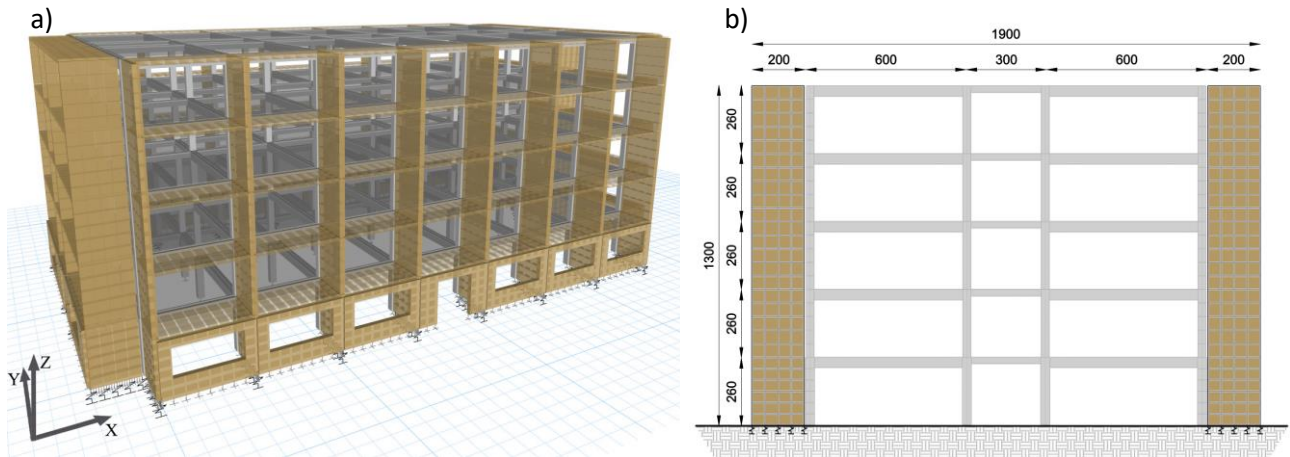

Figure 178 – a) Panoramic view of the finite element model of the application of the timber-based exoskeleton on the Brasov MRF structure; b) elevation scheme of the timber-based exoskeleton applied to a RC MRF (cm as units)

CLT slabs are provided horizontally, creating a “bookshelf” in which the different architectural solutions are provided, guaranteeing the new performing envelopes (Figure 178a).

While the vertical walls are made of 200 mm thick CLT panels composed of five layers of birch (40-40-40-40-40 mm) [162], the slabs are made of 160 mm CLT spruce panels with five layers (40-20-40-20-40 mm) and are connected at each floor by means of a moment-resisting post-tensioned connection that adapts the analytical behaviour presented by F. Wanninger and A. Frangi [164, 165]. Both the connections to the foundations and to the existing structures are made with consolidated and simplified solutions, in order to minimise the uncertainties on the numerical analyses and leaving space for further research development. Every wall has been connected to the foundation level with 12 angular brackets (BMF116) and 16 hold-downs (HTT22), distributed on both side of the 2 m width CLT panels.

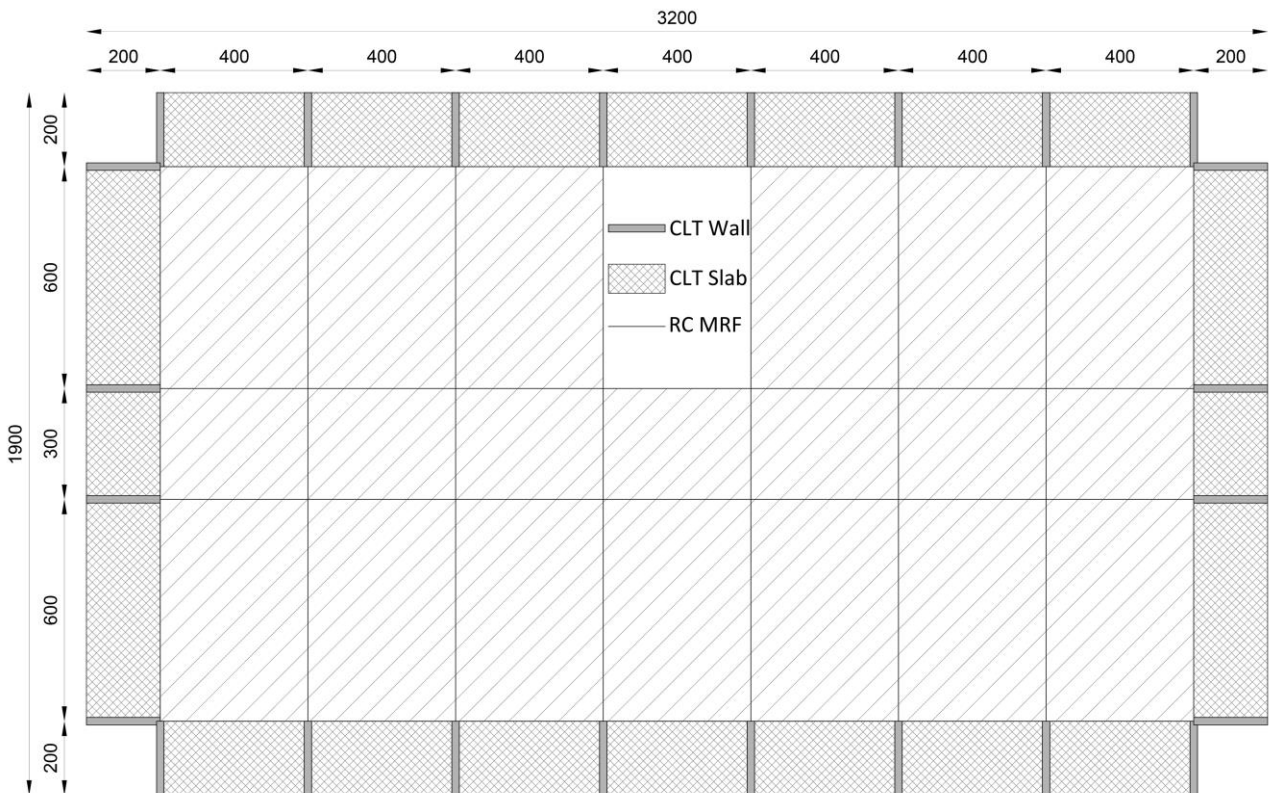

Figure 179 – Planimetric scheme of the timber-based exoskeleton identifying the CLT elements (cm as units)

The connection with the existing structure is designed to transmit only the axial loads acting in direction perpendicular to the existing façade, allowing the interaction between the two structures only for horizontal actions acting in-plane to the CLT walls.

5.3.3.3 PT-CLT Connection and other connectors

PT-CLT Connections

Adapting concepts and principles originally developed for precast concrete constructions [166], post-tensioned (PT) timber systems have been developed and tested since 2005 at the University of Canterbury [167]. The technology takes advantage of unbonded post-tensioned steel tendons, passing through internal cavities in timber beams or walls to create a moment resisting connection. The seismic demand is satisfied through controlled rocking between structural elements and tendon elongation, which also ensures recentering capabilities. Thus, energy-dissipation devices (replaceable mild steel components, viscous or friction dampers) could be provided creating hybrid connections that are characterised by the typical flag-shaped behavioural law (Figure 180). For the sake of brevity a complete state of the art on Pre-Lam technology is not summarised here, but reference is made to [168] and Section 6.1.

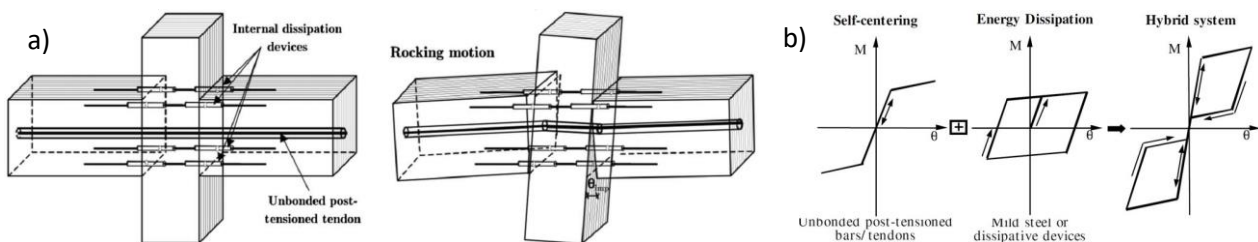

Figure 180 – a) The application of a hybrid concept to LVL frame systems; b) the idealised flag-shape hysteresis loop – Source: [167]

As mentioned in the previous section, direct reference to the analytical method reported in [164, 165] was made for the adaptation of the PT connection to CLT panels. With difference from the New Zealand experience, at the ETH Zurich the PT frames are developed with glulam made from Norway spruce, and present a reinforcement made of European ash where high stresses perpendicular to grain occur (column and bottom side of the beams), avoiding the use of steel reinforcements in the joints. Extensive experimental testing have been performed under both gravity and lateral loads, on single column-beam subassemblies and an entire three-spans frame, ending with the construction of a prototype [169] (Figure 181).

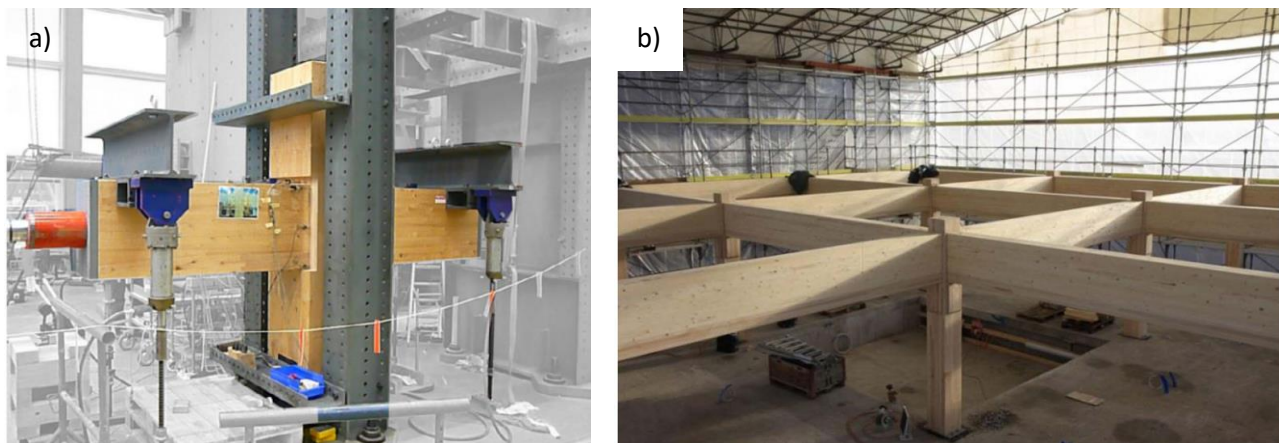

Figure 181 – Glulam column-beam specimen; b) first elevation of the ETH House of Natural Resources [169]

The analytical model is based on springs that represent the softer column and only bear compressive forces. The beam ends at the interface and behaves like a rigid body due to the higher strength and stiffness of the timber components in parallel to grain direction. Hence, the model corresponds to a (stiff) foundation on (soft) ground (Winkler theory) [164]. Since there are no dissipating elements, a gap occurs in the interface as soon as there is no compression at either the top or the bottom edge of the connection. The analytical model describes the behaviour of the connection (moment-rotation) and, based on equilibrium of forces and bending moments at the interface, leads to three stages that depend on the value of the neutral axis x (Figure 183c) [164, 170].

1. Before decompression ($x=h$); the beam is in full contact with the column. Linear behaviour.
2. After decompression ($x<h$); a gap occurs at the edge of the beam. Non-linear behaviour.
3. Tendon elongation ($x<h/2$); when the neutral axis goes below the tendon, the latter gets elongated, resulting in an increase in tendon force and stiffness. Non-linear behaviour with increased slope.

Asymmetrical loads imply shear deformations in the column that depends on the eccentricity of the resultant compressive forces on the two interfaces of the joints. This occurs in the outer joints and more significantly in the inner ones when subjected to horizontal loads as shown in Figure 182.

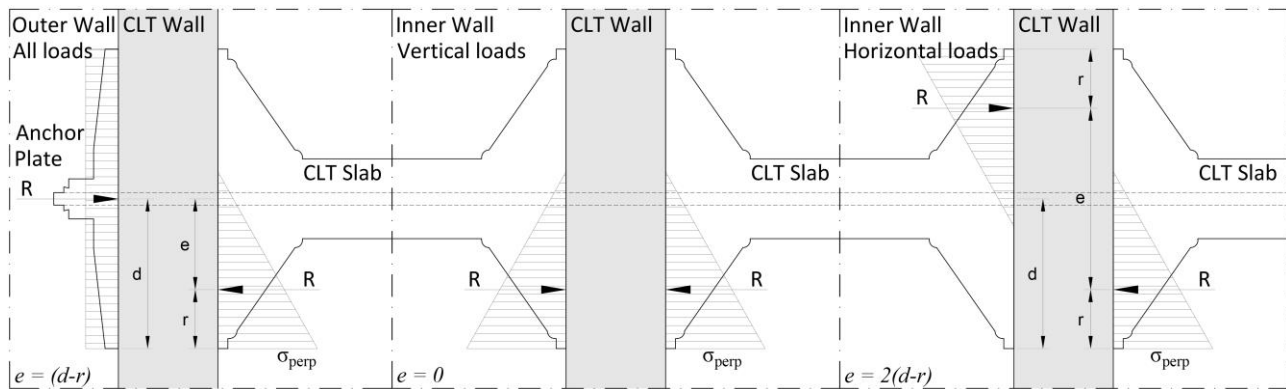

Figure 182 – Distribution of stresses at the connection interfaces of outer and inner walls in the cases of vertical and horizontal loads (VL, HL) for the adaptation to CLT panels

The transition from a beam-column system with linear elements to a system with two-dimensional elements involved the use of a composite steel plate to increase the contact surface between horizontal and vertical elements, maintaining adequate rotational stiffness (depending on the height of the horizontal element, considering the steel plate) without encountering a premature failure of the grain compressed perpendicularly (Figure 183).

This connection steel plate is composed by a large steel plate (600x2000 mm and 20 mm thick), with two angular brackets in L-shape (200x150x18 mm) and four steel pipes (Figures 183a and 183b). The large plate with the L-profiles allows to increase the height of the horizontal element for the evaluation of the rotational behaviour while the steel pipes are inserted in specific holes of the CLT vertical element to transfer the vertical loads. The holes in the CLT provide tolerances, allowing a relative rotation of the plate, and the steel pipes must overlap one another during the assembly of inner joints ($\Phi 48.3 \times 2.6$ mm and $\Phi 60 \times 2.16$ mm). Reinforcing LVL made of hardwood is provided at the contact interface between the horizontal CLT element and the smaller side of the angular steel profile to avoid the crushing of the grain (Figure 185). Alternatively, a stiffer external layer could be already provided, manufacturing the CLT slabs. The steel unbonded tendon passes through the horizontal elements along their development and across the vertical one. It is composed by four wired strands with a cross sectional area about 600 mm², Young's modulus of 197 GPa and a maximal tension strength about 1'770 MPa (ETA-13/0810 in [171]).

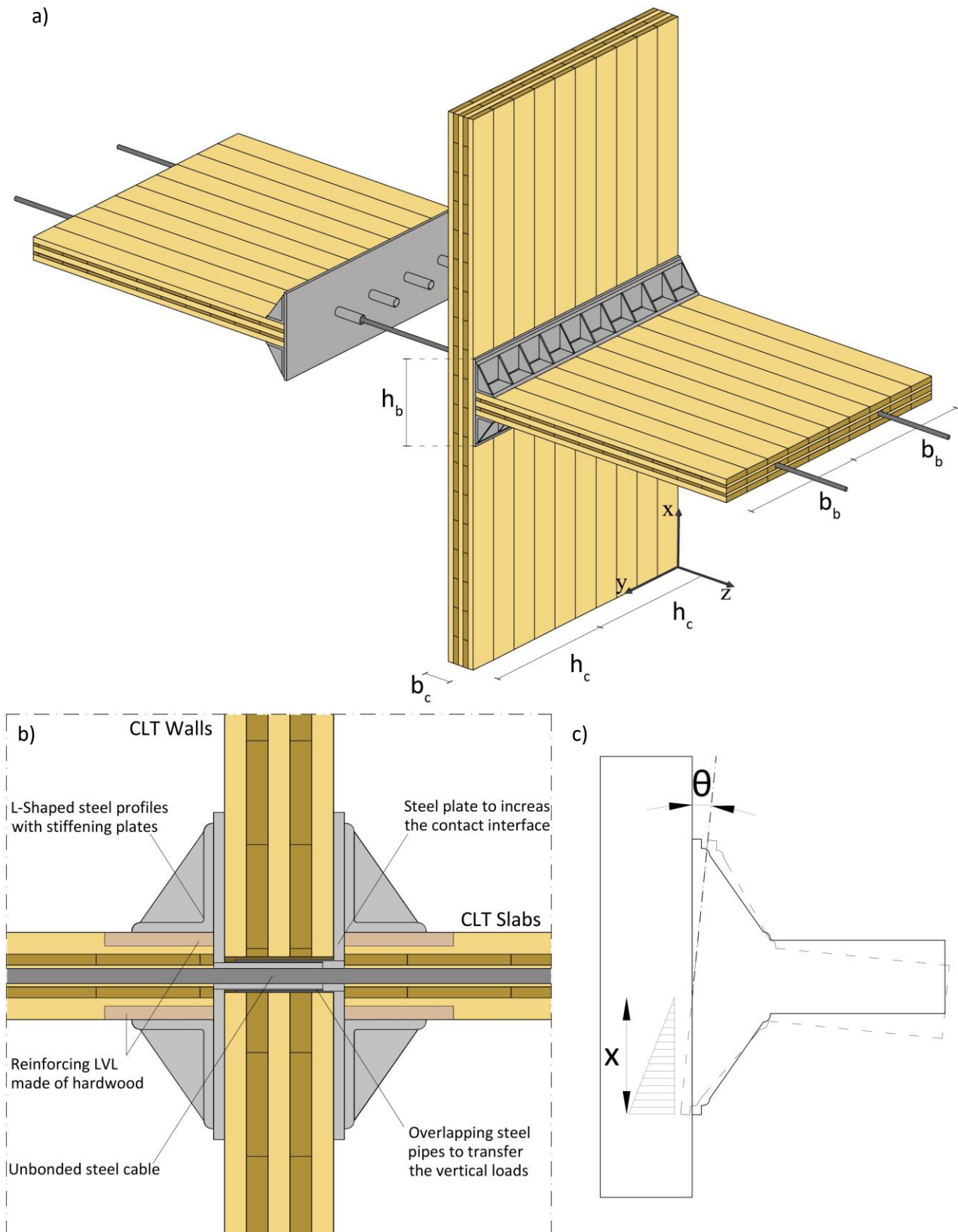

Figure 183 – a) PT-connection between CLT panels by means of steel unbonded cables and steel composed plates; b) detail of the PT-CLT connection with steel composed plates; c) schematic representation of the values resulting from the analytical model (rotation ϑ , stresses perpendicular to grain in the vertical element σ_{perp} and, neutral axis x)

Through this system the analytical model presented in [164, 165] was adapted. In Table 153 a comparison between the input data used for the calculation of the rotational spring is reported with reference to the notations of Figure 183a. S_{xz} represents the shear stiffness of the CLT in the xz -plane as calculated in [161].

Table 153 - Comparison between the values used in [164], referring to a column specimen made of ash, and the CLT vertical element made of birch; inputs used for the calculation of the rotational behaviour (half of the total depth)

	$E_{90,mean}$ (MPa)	$G_{0,mean}$ (MPa)	S_{xz}/b_c (MPa)	$f_{c,90,k}$ (MPa)	b_c (mm)	h_c (mm)	b_b (mm)	h_b (mm)
D40 [164]	860	810	-	8.3	280	600	400	600
CLT-Birch	650	-	246	5	200	1'000	1'000	600

Through the adaptation of the analytical model, it was possible to obtain the laws describing moment, compression perpendicular to grain in the vertical element, neutral axis position and tension in the tendon in relation to the rotation at the interface. With reference to [164, 165] the equations reported in Table 154 are used to determine the rotational behaviour in the three main phases introduced above.

Table 154 Formulations to determine the rotational behaviour of the PT-CLT connection, based on the analytical method presented in [164].

Before decompression ($x = h_b$)	After decompression ($x < h_b$)	Tendon elongation ($x < h_b/2$)
$c = \frac{E_{90} \cdot 2}{b_c}$	$M_{dec} = P_0 \cdot \frac{h_b}{6}$	$M_{t,el} = P_0 \cdot \frac{h_b}{3}$
$\theta = \frac{\sigma_1 - \sigma_2}{c} \cdot \frac{1}{x}$ (5.47)	$x = 3 \cdot \left(\frac{h_b}{2} - \frac{M}{P_0} \right)$ (5.54)	$x = 3 \cdot \left(\frac{h_b}{2} - \frac{M}{P} \right)$ (5.60)
$M = c \cdot \frac{b \cdot h_b^3}{12} \cdot \theta$ (5.48)	$\theta = \frac{\sigma_1}{c} \cdot \frac{1}{x}$ (5.55)	$\theta = \frac{\sigma_1}{c} \cdot \frac{1}{x}$ (5.55)
$\sigma_{1,2} = \frac{P_0}{A} \pm \frac{M}{W} = \frac{P_0}{b \cdot h_b} + \frac{M}{b \cdot h_b^2/6}$ (5.49)	$M = P_0 \cdot \left(\frac{h_b}{2} - \sqrt{\frac{2}{9} \cdot \frac{P_0}{b \cdot c \cdot \theta}} \right)$ (5.56)	$\Delta L_P = \theta \cdot (d - x)$ (5.61)
$r = h_b - \frac{\sigma_2 \cdot \frac{h_b^2}{2} + (\sigma_1 - \sigma_2) \cdot \frac{h_b^2}{3}}{\sigma_2 \cdot h_b + (\sigma_1 - \sigma_2) \cdot \frac{h_b}{2}}$ (5.50)	$\sigma_1 = \frac{2P_0}{3 \cdot b \cdot \left(\frac{h_b}{2} - \frac{M}{P_0} \right)}$ (5.57)	$P = P_0 + A_P \cdot E_P \cdot \frac{\theta \cdot (d-x)}{L_P}$ (5.62)
$\gamma = \frac{R}{S_{xz} \cdot A_c}$ (5.51)	$r = \frac{x}{3}$ (5.58)	$r = \frac{x}{3}$ (5.58)
$\theta_{GA} = \frac{\gamma - e}{h_b} = \frac{R}{S_{xz} \cdot A_c} \cdot \frac{e}{h_b}$ (5.52)	$\theta_{GA} = \frac{R}{S_{xz} \cdot h_c} \cdot \frac{e}{h_b}$ (5.59)	$\theta_{GA} = \frac{R}{S_{xz} \cdot h_c} \cdot \frac{e}{h_b}$ (5.59)
$R = P$ (5.53)		

x	neutral axis depth	R	resultant force
h_b	height horizontal element	A_c	cross sectional area vertical element
c	spring constant	e	eccentricity
b_c	width vertical element	θ_{GA}	rotation due to shear deformation
E_{90}	Young's modulus perpendicular to grain	S_{xz}	shear rigidity of the CLT
θ	rotation	h_c	height vertical element
$\sigma_{1,2}$	stresses at the bottom and top interfaces	ΔL_P	elongation of the tendon
M	moment	d	position of the tendon
b	width horizontal element (b_b)	P	increased tendon force
P_0	initial tendon force	L_P	length tendon
r	position resulting force	A_P	cross sectional area of the tendon
γ	shear angle	E_P	modulus of elasticity of the tendon

Below in Figure 184 the relationships mentioned above are shown, with reference to half of the depth of the system (1 m with one steel cable) and an initial tension (P_0) set to 500 kN. It is evident how relevant the shear deformation of the CLT vertical element on the rotational stiffness is due to the lower value S_{xz}/b_c compared to $G_{0,mean}$ from [164].

Finally, it is important to mention that the analytical model developed in [164] was particularly precise until the phase of tendon elongation. In this phase the analytical model was losing precision, overestimating the stiffness and implying the use of an experimental factor to correct the spring stiffness of the analytical model at the beginning of the tendon elongation [164]. However, for the purpose of this study, the connection between CLT components is meant to stay in the elastic range under the design seismic loads, thus allowing the exploitation of the analytical model without experimental coefficients.

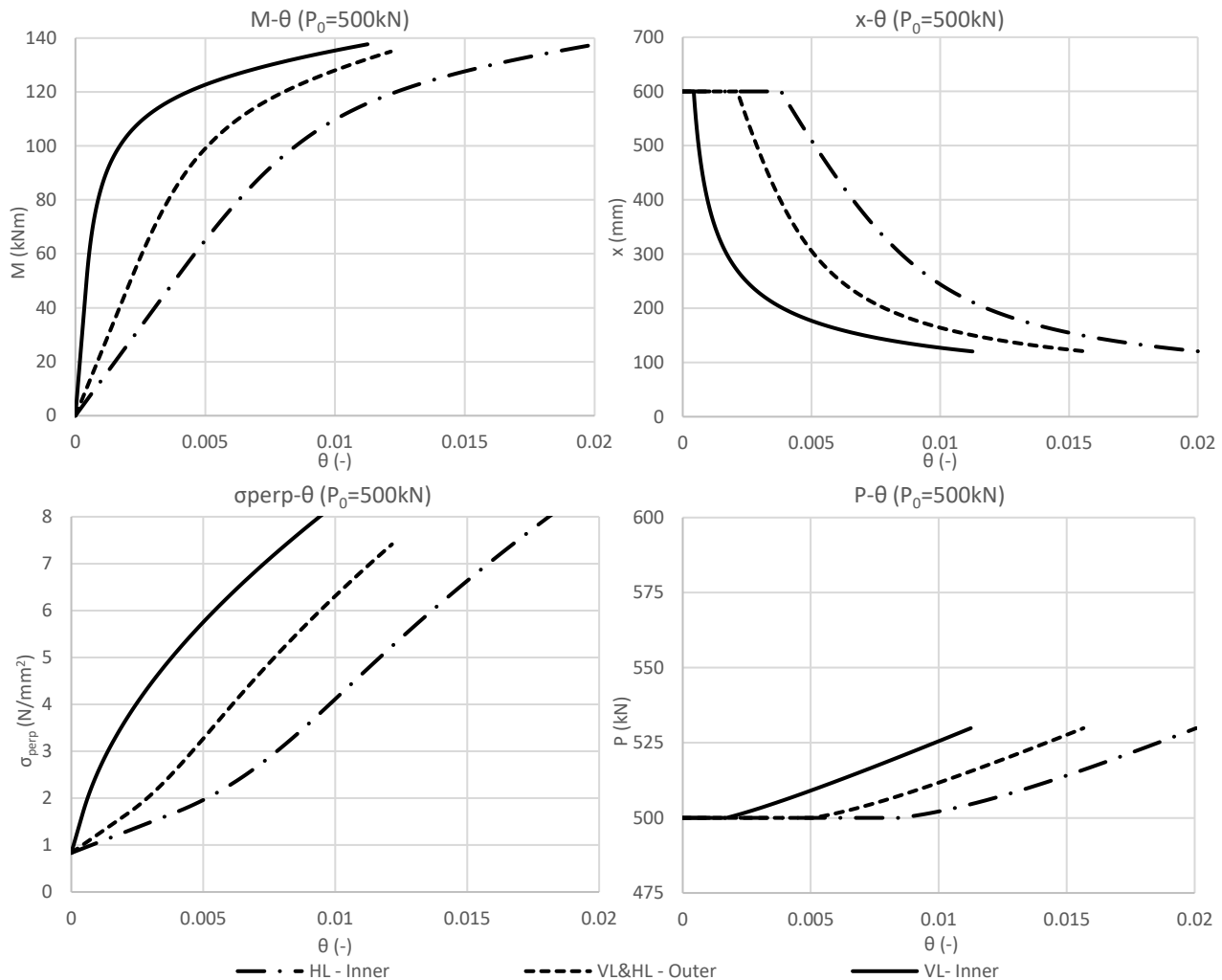
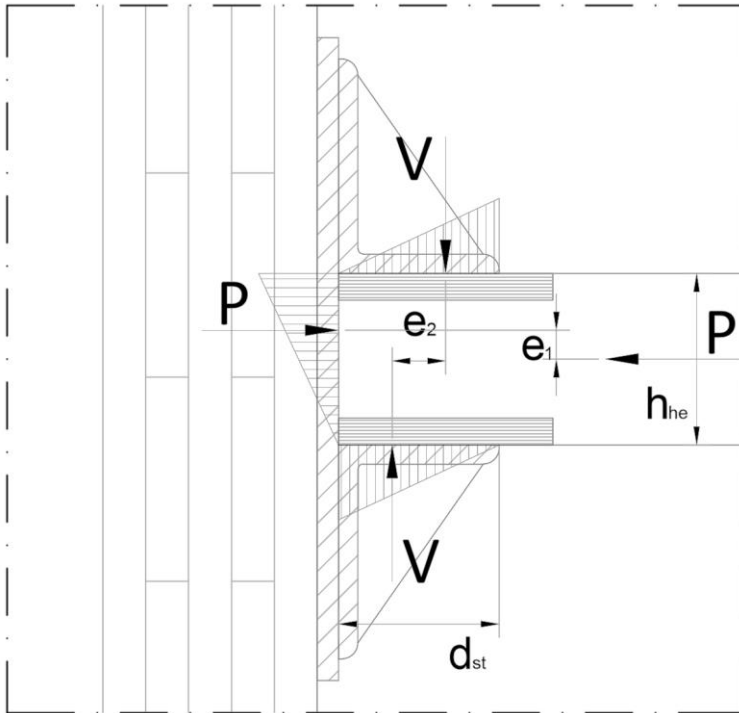

Figure 184 – Moment-rotation behaviour, compression perpendicular to grain, neutral axis position and tension in the tendon in relation to the rotation at the PT-CLT connection interface, calculated for the inner elements with vertical loads (VL) and horizontal loads (HL) and for the outer elements

The failure of the connection is linked to the crushing of the grain, which does not imply the collapse of the structure, but means an irreversible damage of the components. From the graphs in Figure 184 it is possible to identify the rotation which corresponds to a compression perpendicular to the grain of the vertical element, which for birch is fixed at 5 MPa (considering the mean value). Furthermore, with the equilibrium between the moment at the interface and the prestressing force P , the force V can be determined, which defines the stresses at the interface between the steel angle brackets and the pieces of LVL reinforcement, as shown in Figure 185. By estimating the stresses at the interfaces, a verification of the connection was allowed, considering the design loads from the linear dynamic analysis. A mechanical bond of the LVL layers to the horizontal CLT element would also enable the possibility of replacing these elements in case of major events, increasing the durability of the solution (resilience). In addition, calculations have shown that grain

crushing in the horizontal elements occurs before that in the vertical elements, indicating a strength hierarchy (Section 5.3.3.5, verifications of the exoskeleton).



$$M = P \cdot \frac{h_{he}}{6} + V \cdot \frac{d_{st}}{3} \quad (5.63)$$

$$V = \left(M - \frac{P \cdot h_{he}}{6} \right) \frac{3}{d_{st}} \quad (5.64)$$

$$\sigma_{perp,LVL} = \frac{2V}{d_{st} \cdot b_b} \quad (5.65)$$

Figure 185 – Forces and stresses affecting the end of the horizontal CLT panels

A more detailed description of the state of the art, the existing analytical models and the provided adaptation is given in Section 6. Laboratory experiments were carried out to demonstrate the possible application of the PT system as connection system between vertical and horizontal CLT panels.

Connectors at foundation level

The use of hold-downs and angular brackets as connectors for CLT structures is widely spread in construction practice and extensively investigated in research [115, 172-174]. Due to this reason, typical connectors were exploited at the foundation level distributed on both sides of the CLT walls. With specific reference to [172] commercial products already characterised by linear strength properties, secant stiffness and non-linear behavioural laws were provided:

- 12 angular brackets (BMF 90x48x3x116 mm), fastened to the CLT walls with 12 nails (or screws) $\Phi 4/60$ mm and with 2 M12 bolts to the foundation, were provided in the middle of the walls as shear anchors with a contribution also to prevent up-lift loads (see Figure 186);
- 16 hold-downs (HTT22), fastened to the CLT each with 22 nails (or screws) $\Phi 4/60$ mm and with 1 M12 bolt to the foundation, were placed towards the corners of the walls to resist overturning forces (Figure 186).

The friction at the foundation level was calculated, considering the vertical loads deriving from the quasi-permanent load combination. Due to the lightweight of the material and the limited dimensions of the external CLT structure, the axial loads in the walls are limited with a consequent small relevance of the friction at the base. Considering a friction coefficient between wood and concrete of 0.62, the contribution of friction is calculated and exposed below in Table 155.

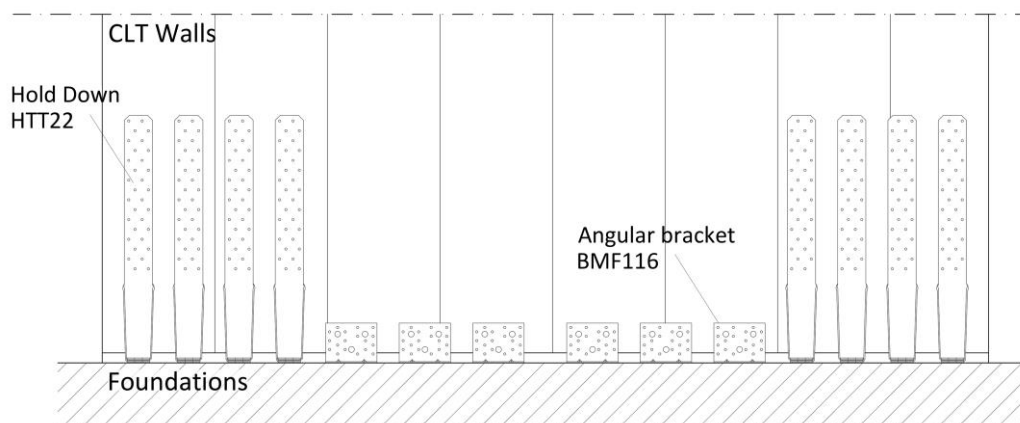

Figure 186 – Multiple connectors at foundation level are represented in the drawing on one side of the CLT wall

Table 155 – Activated friction forces at the bottom of the inner and outer walls considering a friction coefficient between wood and concrete of 0.62

Value	Inner wall (kN)	Outer wall (kN)
N	110.3	68.09
F_{fr}	68.4	42.2

Despite the rapid implementation of the connectors in the numerical model (Figures 191, 192, 194b), their right number was determined iteratively, checking the force-displacement relationship during non-linear static analysis, matching the seismic global safety of the intervention while keeping the connectors (especially the hold-downs located at the edge of the walls) within their maximum allowed displacement.

Connection with the existing structure

As mentioned before, the connection with the existing structure is designed to transmit only axial loads, acting in-plane to the CLT walls. Twenty connectors are distributed along the height of the building, consisting of steel rods ($\varnothing 12/150$ mm) fixed with chemical dowels to the CLT walls and providing steel plates to be anchored at the vertical RC elements (Figure 187). The threaded galvanised rod made of reinforced steel (B450C) is characterised by a bilinear stress-strain relationship as shown in Figure 194b. This steel connector plate must provide specific tolerances that allows relative vertical and horizontal displacements. While the relative vertical displacement results in a maximum of 5 mm (a tolerance of 10 mm is provided), the horizontal displacement is more significant. Considering the roof displacement of the short side (more flexible) under seismic loads and asynchronous vibration modes, it can reach 100 mm. The fixation of the steel plate to the RC elements is hypothesised from the façade plane with bolts chemically anchored to the RC. Particular attention on this connection must be paid for a realistic application. It is in fact important to have a reliable level of knowledge of the structural existing elements and materials in order to rely on chemical fixations. Additionally, a careful evaluation of the extra loads applied on the columns must be done. Depending on the existing elements, the steel plate may be connected to a steel reinforcing jacketing of the external RC columns to avoid local collapses. In order to transfer compressive loads between the RC frames and the CLT walls and so avoiding instability in the bars, hardwood components are provided in-between the steel connectors.

During the installation procedure, the steel bars could be already fixed to the CLT walls and arrive at the construction site with the steel plates in position (hanging from the chemical anchored steel rebars) for the fixation to the RC elements.

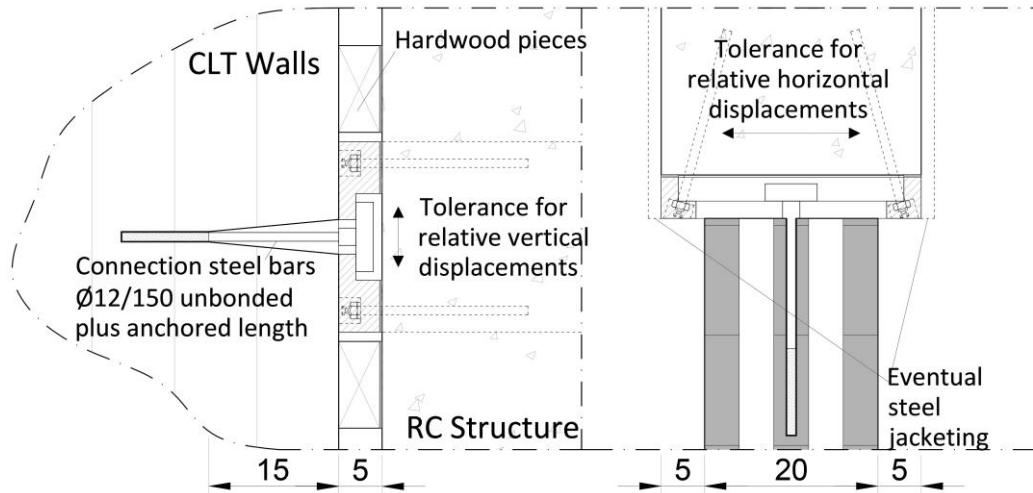

Figure 187 - Sketches of the vertical distributed connection between CLT walls and RC vertical structural elements

5.3.3.4 Modelling parameters

Load patterns

As presented in Chapter 7, the architectural units are divided into three types: balcony, sun space and extra room. The intention of the project is to allow users the freedom to customise their living space by choosing between these types, according to their economic availability or simply aesthetics.

The details of the various partitions (floors and walls) were not defined at the time of the analyses and the following loads were considered based on preliminary assumptions. The categories chosen for the imposed and snow loads refer to the Eurocode 1 [134, 135]. The balcony live load was used for all the external units as the most conservative. Therefore, surface loads were applied on the new areas within the exoskeleton.

Table 156 – Load patterns assigned to the floors of the extensions – Source: [134, 135]

	CLT floors		
	Self-weight	Dead load	Live load
n floor	0.737 kN/m ²	0.5 kN/m ²	Balcony = 4 kN/m ²
Roof floor	0.737 kN/m ²	0.5 kN/m ²	Snow = 2 kN/m ²

The loads resulted conservative, even after the definition of the technological components (Section 7.2). Where the extra-room was adopted, the live load considered was higher than necessary, compensating a lower dead load (neglecting external walls).

Numerical tests on CLT elements

In the numerical model, CLT panels are realised with shell layered elements, providing cross-layers of the implemented orthotropic wood material (CLT made of birch and spruce as defined in Table 152). The correct behaviour of the CLT panels is verified, based on the practical examples presented in [161, 175]. Basic FEM models were created to check the accuracy of the software by comparing the results of the manual calculations with those obtained when using shell layered elements as CLT panels in the FEM.

In this regard, a 7-layers (21-21-21-21-21-21-21 mm) symmetrical CLT panel is considered in [175]. All lamellae are made of spruce (C24) glued on the sides. Figure 188 represents the CLT panel considered in the evaluations.

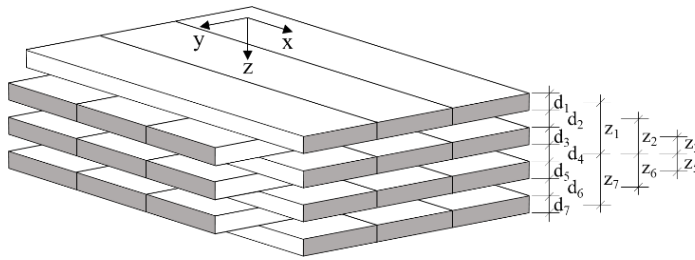

- $E_0 = 11000 \text{ MPa}$
- $E_{90} = 370 \text{ MPa}$
- $G_{mean} = 690 \text{ MPa}$
- $G_{R,mean} = 69 \text{ MPa}$

Figure 188 – CLT panel adopted for the numerical tests and relative mechanical characteristics – Source: [175]

Deformations due to out-of-plane loads

In order to check whether the shear stiffness is correctly recorded by the software, it is necessary to calculate a single span beam under a distributed load. Referring to [175] for the calculations, Table 157 shows the result in terms of beam centreline deflection, together with the associated deviation.

Table 157 – FEM numerical test for out-of-plane deformations – Source: [175]

Hand-calculations	FEM	Δ
<p style="text-align: center;">$w_{x=2,25m} = 13.52 \text{ mm}$</p>	<p style="text-align: center;">$w_{x=2,25m} = 12.9 \text{ mm}$</p>	4.06%
<p style="text-align: center;">After the application of the reduction factor to the modulus of elasticity (E)</p> <p style="text-align: center;">$w_{x=2,25m} = 13.72 \text{ mm}$</p>	<p style="text-align: center;">$w_{x=2,25m} = 13.72 \text{ mm}$</p>	1.06%

The shell layered elements follow a Kirchhoff formulation and as stated in [175] do not consider the shear stiffness S_{xz} with an error that decreases with the length of the element (greater slenderness). Therefore, to take into account the shear deformation, a reduction of the modulus of elasticity is applied to the imputed orthotropic materials for the different layers, depending on the static scheme of each element considered (Table 158) as shown in [175].

$$B_{eff,x} = \frac{B_x}{1 + \frac{B_x \cdot \pi^2}{S_{xz} \cdot l^2}} \rightarrow R_F = \frac{B_{eff,x}}{B_x} - \text{reduction factor} \quad (5.66)$$

Table 158 – Reduction factors imputed on the orthotropic material used in the software to describe the timber layers in the CLT elements. The static schemes used do not take into account the rotational stiffness of the PT-connections in the cases of horizontal slabs and walls in the levels from 1 to 5

Structural element	Static scheme	Reduction factor applied to E of the timber
Horizontal slabs		0.81
Walls at the ground floor		0.89
Walls at the typical floor		0.67

Stability with second order effects

The critical buckling load is evaluated in relation to the shear stiffness and the resulting moment according to 2nd order theory. Referring to [175] for the calculations, the result in terms of 2nd order moment is shown in Table 159, together with its deviation. The force F is applied centrally on the surface of the CLT element. An ideally straight wall element with a buckling length of $S_k = 2.80$ m is assumed.

Table 159 – FEM numerical test for stability and 2nd order theory – Source: [175]

Hand-calculations	FEM	Δ
$M_I = 0.98 \cdot 10^{-3} \text{ MNm/m}$ $M_{II} = 1.08 \cdot 10^{-3} \text{ MNm/m}$	$M_I = 0.97 \cdot 10^{-3} \text{ MNm/m}$ $M_{II} = 1.06 \cdot 10^{-3} \text{ MNm/m}$	1.02% 1.85%

In-plane shear stiffness

Since cross-laminated timber elements are used to strengthen buildings, the D_{xy} stiffness provided by the software must be calculated correctly. It can be verified with the following example (Table 160).

Table 160 – FEM test for in-plane shear stiffness – Source: [175]

Hand-calculations	FEM	Δ
$u_y = 0.28 \text{ mm}$	$u_y = 0.276 \text{ mm}$	1.43%

Torsional stiffness

In order to verify which value of torsional stiffness is decisive for the software used, the CLT panel subjected to torsional stress at the corner (as shown in Table 161) must be considered. The deflection u_z of the corner point of the slab at the coordinates $x = 0$ m and $y = 2$ m is given. The deflection of the corner point is calculated, neglecting the shear deformation (Kirchhoff calculation) [175].

Table 161 – FEM test for in-plane shear stiffness – Source: [175]

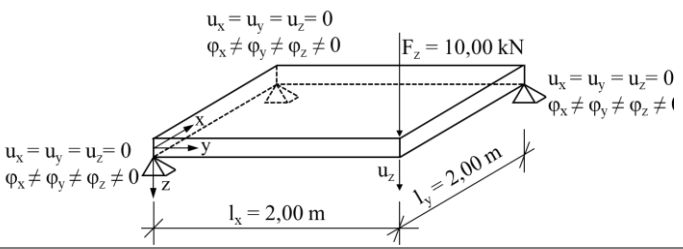
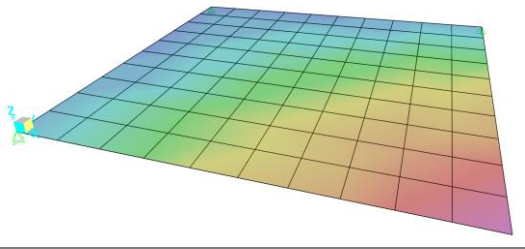
Hand-calculations	FEM	Δ
 <p style="text-align: center;">$u_z = 54.75$ mm</p>	 <p style="text-align: center;">$u_z = 57.03$ mm</p>	<p style="text-align: center;">4%</p>

The numerical tests gave good results with acceptable deviations apart from the deformations due to out-of-plane loads, which were corrected by inserting reduction factors to the elastic moduli of the considered material for each structural element (Table 158).

PT-CLT Connection and numerical tests

Multi-linear springs with linear stiffness and relative linear and non-linear behavioural laws are implemented in the model to represent the various connectors involved (PT-CLT-connections, hold-downs, angular brackets, steel fixing rods) and the activated friction.

The PT-CLT-connection was implemented in the FEM with rotational springs (Figure 189a) characterised by the behavioural law (moment-rotation) and illustrated in Figure 184, as well as a linear stiffness calculated, considering the angular coefficient of the line in the elastic phase (Table 162). Since shear deformations were relevant only for horizontal loads, two models were developed independently with PT-CLT connections, set respectively for vertical (ultimate limit state, ULS and serviceability limit state, SLS) and horizontal loads (significant damage limit state, LS SD and damage limitation limit state, LS DL). The 2 m depth shell-layered elements, representing the CLT structural elements, were regularly divided in four parts, creating five joints at the edges. The stiffness of each spring (five for each PT-CLT-connection) is determined, considering double of the depth of the single 1 m system (multiplying by 2) and then assigning 1/5th to each spring located at the connecting side. In the same way the moment-rotation behaviour is distributed along the rotational springs, as shown in Figure 189b.

Table 162 – Rotational effective elastic stiffness of the PT-CLT connections referred to 1m CLT structure

Value	Inner PT-connection (kNm/rad)	Outer PT-connection (kNm/rad)
<i>K_{vert.loads}</i>	117'000	23'565
<i>K_{horiz.loads}</i>	13'102	23'565

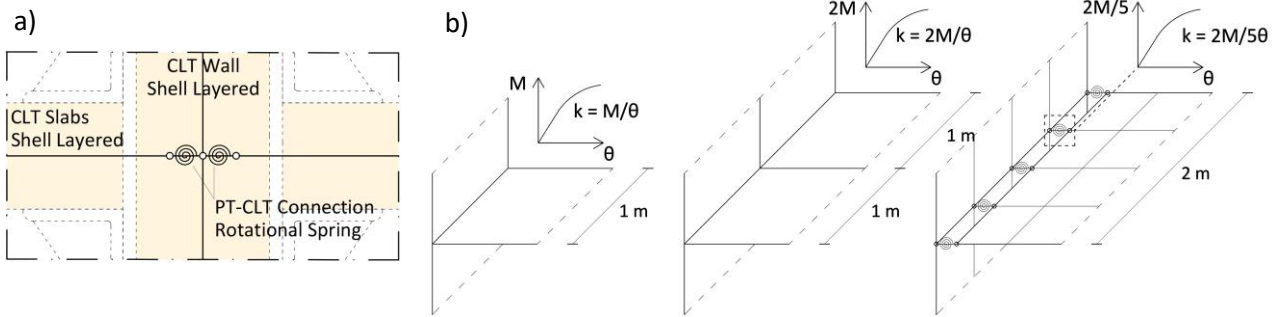

Figure 189 – a) FEM-scheme of the PT-CLT inner connection; b) distribution of the PT-CLT connection in multilinear rotational springs

The modelling strategy was tested prior to perform the full analysis by comparison with manual calculations (5.67), with reference to [165].

First, a single-span frame was tested under a horizontal load of 1500 N (Table 163). Then a seven-bay single-storey frame of the same type was tested under 150 kN (Table 164), with reference to the pushover tests presented in [165].

Table 163 – FEM test of the behaviour of the rotational springs

Hand-calculations	FEM	Δ
$F = 1500 \text{ N}$	-	
$h_c = 2500 \text{ mm}$	-	
$EJ = B_{x(CL T)}$	-	
$GA = S_{xz(CL T)}$	-	
$K = 2k_o = 2 \cdot 53193374919 \text{ Nmm/rad}$	11 Springs with $k_{eff} = k_o/11$	
$\delta_I = \frac{F \cdot h_c^3}{2(3EJ)} + \frac{F \cdot h_c}{2(GA)} + \frac{F \cdot h_c^2}{K} = 0.789 \text{ mm} \quad (5.67)$	$\delta_I = 0.725 \text{ mm}$	8.11%
Applying $R_F = 0.89$ to the modulus of elasticity (E)	$\delta_{II} = 0.8 \text{ mm}$	1.39%

The shell layered elements with a depth of 1 m were divided into 100 mm regular meshes, and a spring was assigned to each edge of the mesh as connecting element between the horizontal and vertical elements. Each spring is characterised by a linear stiffness k_{eff} (rotation R3), obtained by considering the number of springs provided to represent the PT-CLT connection. The portal is then subjected to a horizontal force that determines the displacement verified for the test. The need for the reduction factor (R_F) to consider the out-of-plane shear deformation of the vertical panels is again confirmed.

In a second step, a seven-bay portal was tested in the same way, considering a different stiffness for inner and outer joints, and increasing the horizontal loads. The result of this numerical test is presented in Table 164.

Table 164 – FEM test of the behaviour of the rotational springs

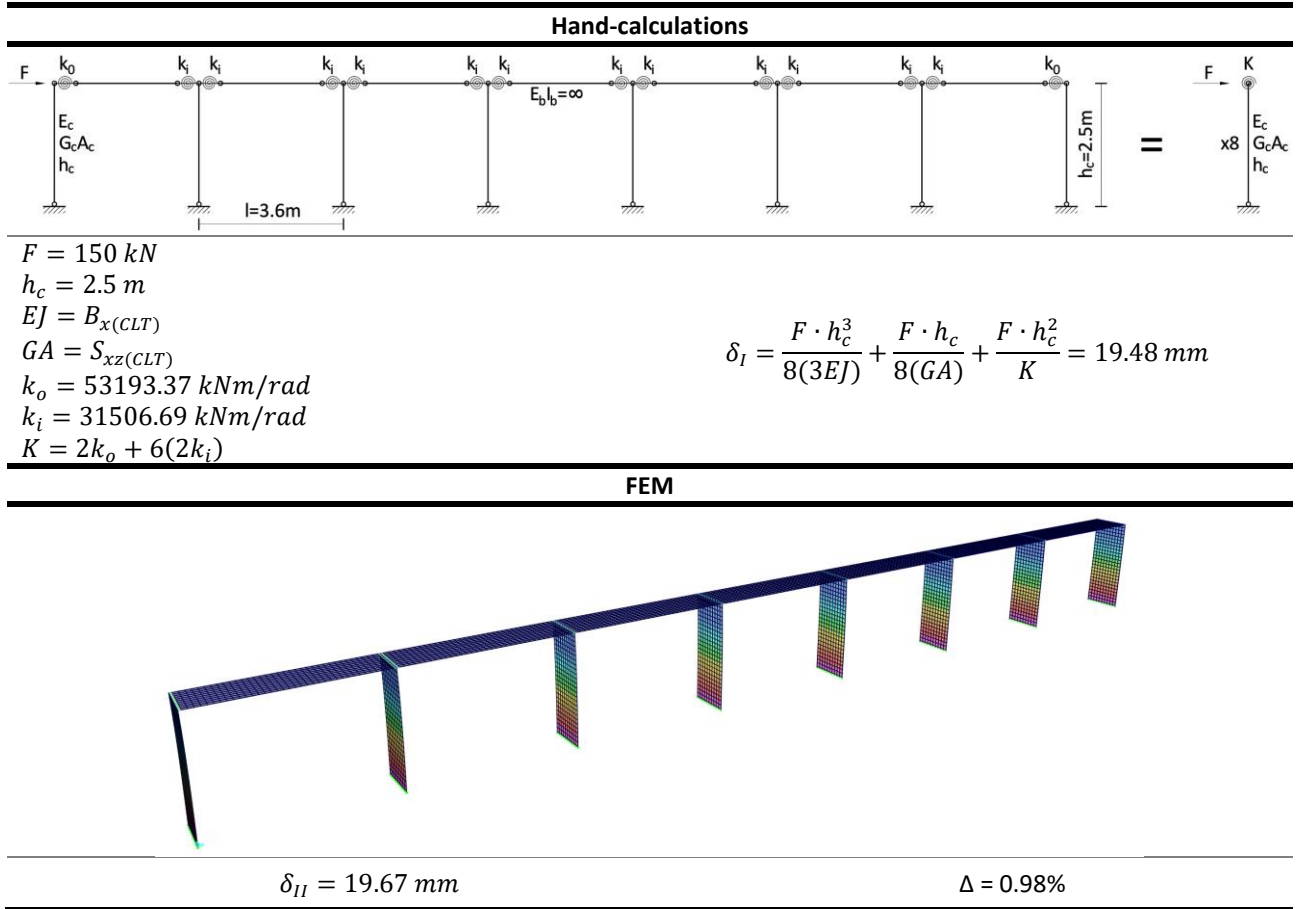

$F = 150 \text{ kN}$
 $h_c = 2.5 \text{ m}$
 $EJ = B_{x(CL T)}$
 $GA = S_{xz(CL T)}$
 $k_o = 53193.37 \text{ kNm/rad}$
 $k_i = 31506.69 \text{ kNm/rad}$
 $K = 2k_o + 6(2k_i)$

$$\delta_I = \frac{F \cdot h_c^3}{8(3EJ)} + \frac{F \cdot h_c}{8(GA)} + \frac{F \cdot h_c^2}{K} = 19.48 \text{ mm}$$

Using the same method, non-linear pushover analyses were performed to verify the application of the behavioural law for the same springs.

Connectors at foundation level and with the existing structure

Regarding the foundation connectors, a series of rigid links is provided at the final side of the shell layered element to adjust the shell subdivisions with the multi-linear springs representing angular brackets, hold-downs, and friction (Figure 190). While angular brackets (BMF116) are characterised by behavioural laws, describing deformations under axial and shear loads, the hold-downs (HTT22) only present the first component. To simplify the model, the springs representing the hold-downs also contain the friction contribution (divided by the number of springs considered along the length). The envelope and load bearing capacity of these connectors are shown in Figures 191 and 192 for single connectors with reference to [172].

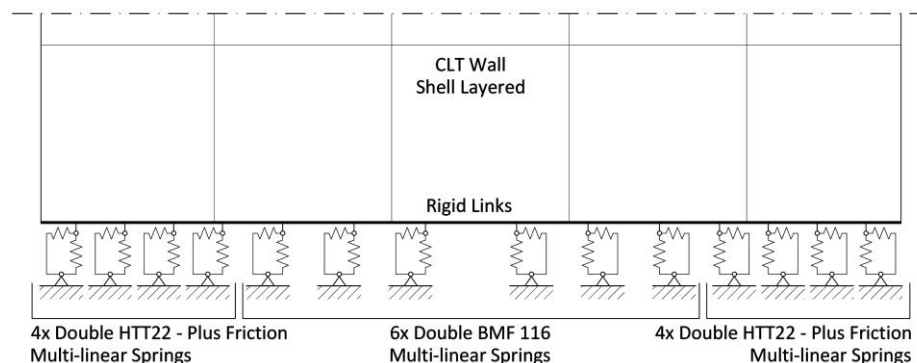

Figure 190 – FEM-scheme of the connectors provided at the base of the shell layered CLT wall on one side

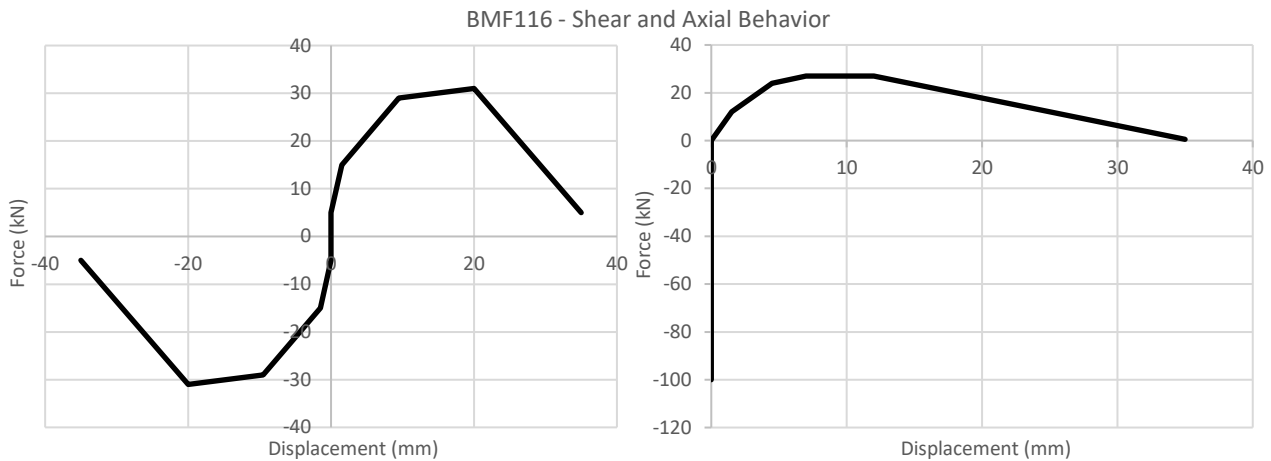

Figure 191 – Envelope and load bearing capacity of the shear anchor with 12 nails of ϕ 4/60 mm, when acting in shear (left graph) and with axial loads (right graph) – Source: [172]

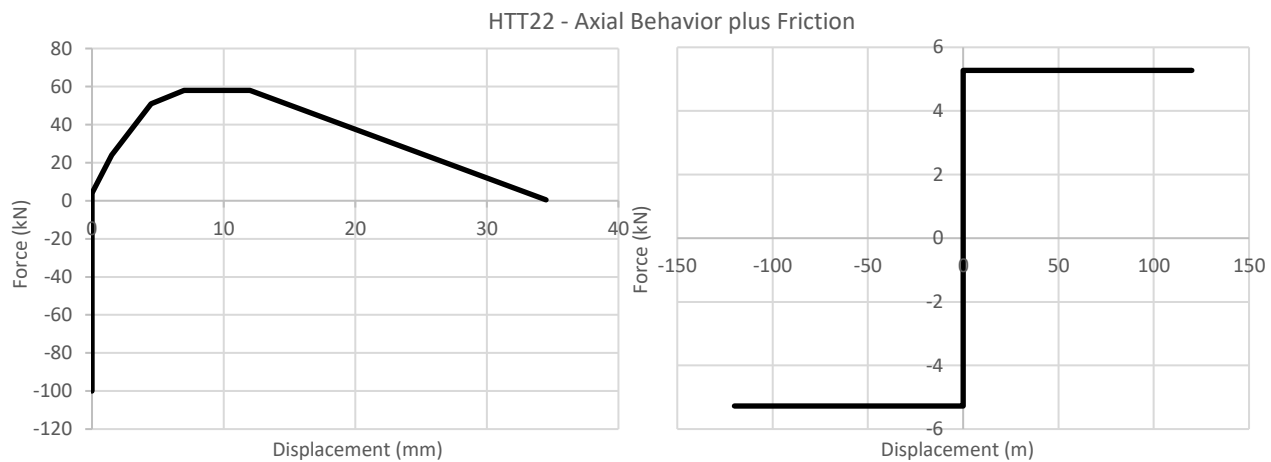

Figure 192 – Envelope and load bearing capacity of the hold-down with 22 nails of ϕ 4/60 mm for preventing up-lifting (left graph) and 1/8 of the friction contribution – Source: [172]

In the FEM, forces and linear stiffnesses of the connectors have been doubled because of a double number of connectors, intended to be applied on both sides of the CLT walls.

Table 165 – Values of the elastic stiffness of the steel connecting rods (ϕ 12), single and double angular brackets (BMF116) and hold downs (HTT22); friction is neglected in linear analyses – Source: [172]

Connector	Single Connector (one side)		Double Connector (two sides)	
	Tensile strain (kN/m)	Shear strain (kN/m)	Tensile strain (kN/m)	Shear strain (kN/m)
$k_{\phi 12}$	158'336	-	-	-
k_{BMF116}	5'000	8'000	10'000	16'000
k_{HTT22}	11'250	-	22'500	-

It is important to mention that in linear analyses the axial behaviour of the connectors cannot be represented correctly due to actual non-linear behaviour from tension to compression. Therefore, since the deformation in the model is twice the one of a real in-plane loaded CLT wall (considered as rigid body, Figure 193), the axial linear stiffness of the connectors has been doubled (5.68) - (5.73).

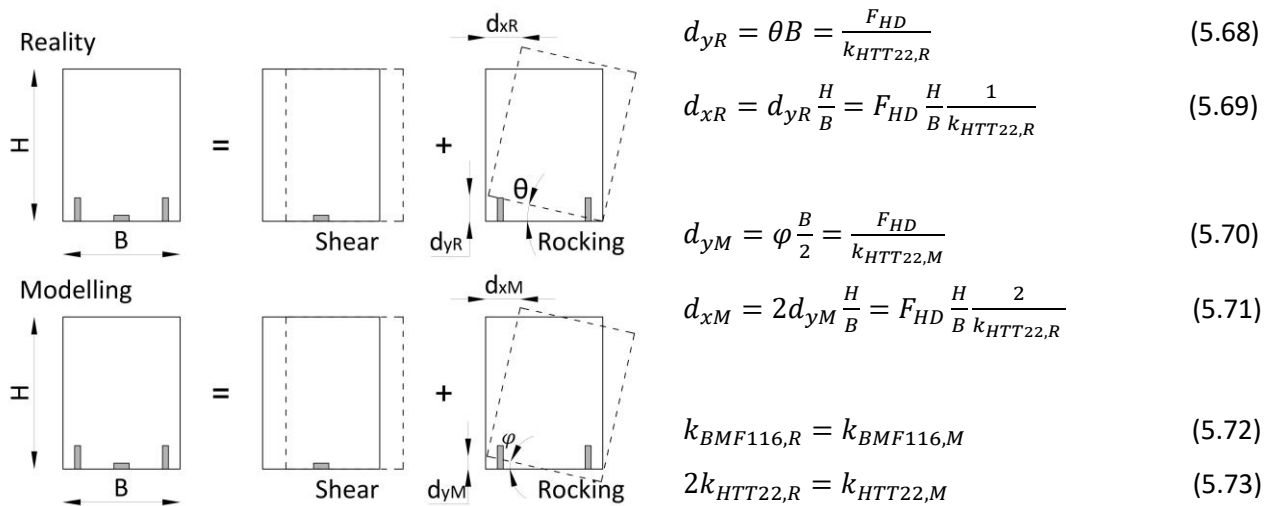

Figure 193 – Connector’s stiffnesses, determination of the axial linear equivalent stiffness to use in the FEM

The connection with the existing structure is realised in FEM with a multi-linear spring of a linear stiffness as reported in Table 8 and an axial linear and non-linear behaviour as represented in Figure 194b. Twenty connectors are provided along the height of the entire structure (four per storey) and connected to the joints of the CLT-shell elements and to rigid links, representing the thickness of the RC columns (Figure 194a).

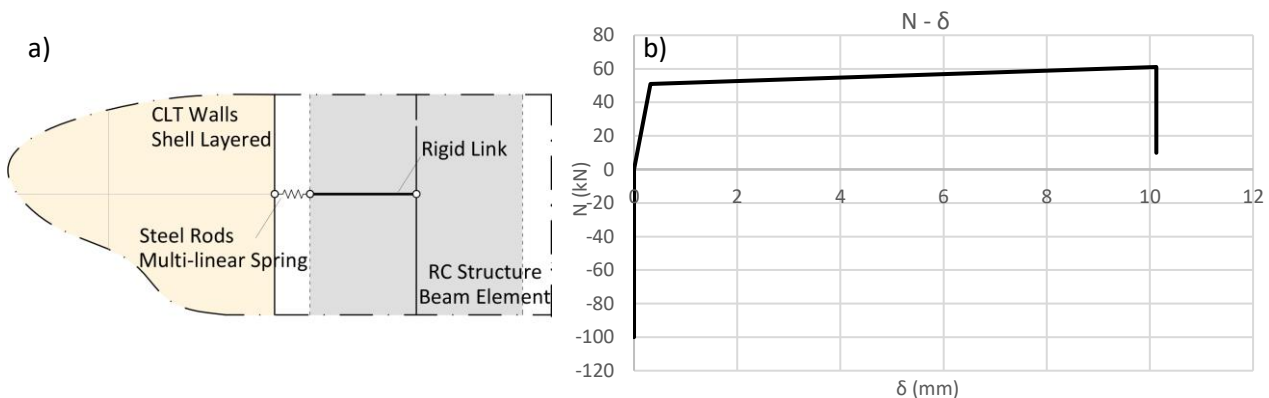

Figure 194 – a) FEM-scheme of the steel fixating rod connection between RC columns and CLT walls; b) envelope and load bearing capacity of the steel rods applied as axial connectors; while the tensile behaviour is characterised by the tensile capacity of the $\phi 12/150$ rods, the compressive transfer is guaranteed by the hardwood pieces

Restraints/Constraints

Given that the connection between the two structures guarantees a collaboration only in transverse direction (in-plane of the shear CLT walls), no diaphragm constraints were applied to the joints belonging to the external structure.

In addition, in line with the choice for the initial state assessment, the foundations were not modelled, and restraints were provided, fixing all six degrees of freedom.

Response spectrum functions and q-factors

The minimum q-factors, calculated as described in Section 5.3.2.3, were selected among the analyses performed in both directions (Table 166). Different design spectra were finally defined, based on the direction and the required stresses.

Table 166 – Ductility reduction factors, overstrength factors and q-factors obtained for all the pushover analyses

LS SD – Project State	R_{μ}	R_s	q-factor
PUSH_X	1.91	1.99	3.81
-PUSH_X	1.89	1.92	3.63
PUSH_X M	1.84	2.07	3.81
-PUSH_X M	1.83	2.07	3.79
PUSH_Y	1.67	1.74	2.90
-PUSH_Y	1.65	1.72	2.84
PUSH_Y M	1.67	1.86	3.11
-PUSH_Y M	1.63	1.95	3.18
Pushover analyses in longitudinal direction (X)			3.63
Pushover analyses in transverse direction (Y)			2.90
Verification for brittle failures			1.50

The application of the exoskeleton makes it possible to increase the q-factors in both directions thanks to a better distribution of the damage along the height of the existing structure. In fact, RC MRF present greater deformations in the lower storeys, implying a collapse that does not allow to exploit the full capacity of the RC structure [9, 113]. As presented in Section 5.3.3.6, through the application of the timber-based exoskeleton, higher displacement capacities can be reached due to a modified deformed shape of the existing structure.

The q-factor values passed from 2.90 to 3.63 for the longitudinal direction (X), and from 2.67 to 2.90 for the transverse direction (Y).

5.3.3.5 Results

Modal analysis

The evaluation of the dynamic behaviour of the building is carried out by means of a modal analysis performed on the structural model.

Table 167 – Results of the modal analysis of the project state of the Brasov MRF; periods are expressed in seconds while participating masses are percentages of the total mass of the building

Mode	Period (s)	Initial State		
		U1	U2	RZ
1	0.942	71.0%	0	≈ 0
2	0.890	0	72.5%	0
3	0.847	0	≈ 0*	4.5%*
4	0.847	0	3.2%*	≈ 0*
5	0.802	≈ 0	0	66.4%
6	0.660	6.72%*	0	≈ 0*
7	0.660	≈ 0*	0	5.5%*

*These percentages are linked to vibration modes involving principally the timber-based exoskeleton in displacements unrelated to the RC MRF

The participating masses (Table 167) and the modal displacements (Figure 195) show that the dynamic behaviour of the structure is substantially regular. The first two vibration modes act along the main two directions and the fifth one represents the torsional global component. The release of the timber-based exoskeleton along the longitudinal direction (in parallel with the existing façades) implies the presence of vibration modes involving the masses of the exoskeleton unrelated in terms of natural frequency to the

modal displacements of the existing RC MRF. Figure 195 represents the vibration modes involving the whole structure (first, second and fifth).

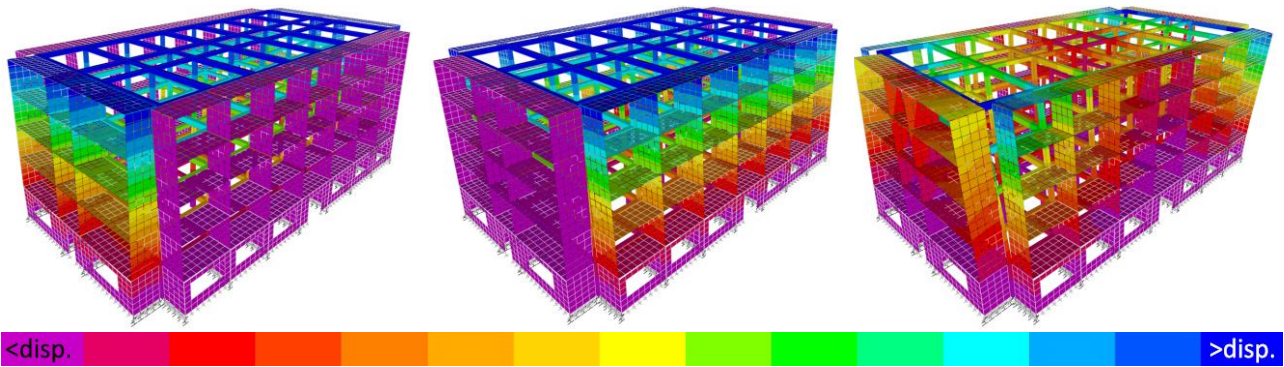

Figure 195 – Representation of the first two vibration modes and the fifth one, in ascending order from left to right; the displacements increase from purple to blue

Linear dynamic analysis

As specified in the previous section (linear dynamic analysis in Section 5.3.2.4), the interstorey drift (d_r) was verified after the application of the timber strengthening solution for both the main directions (Figure 196).

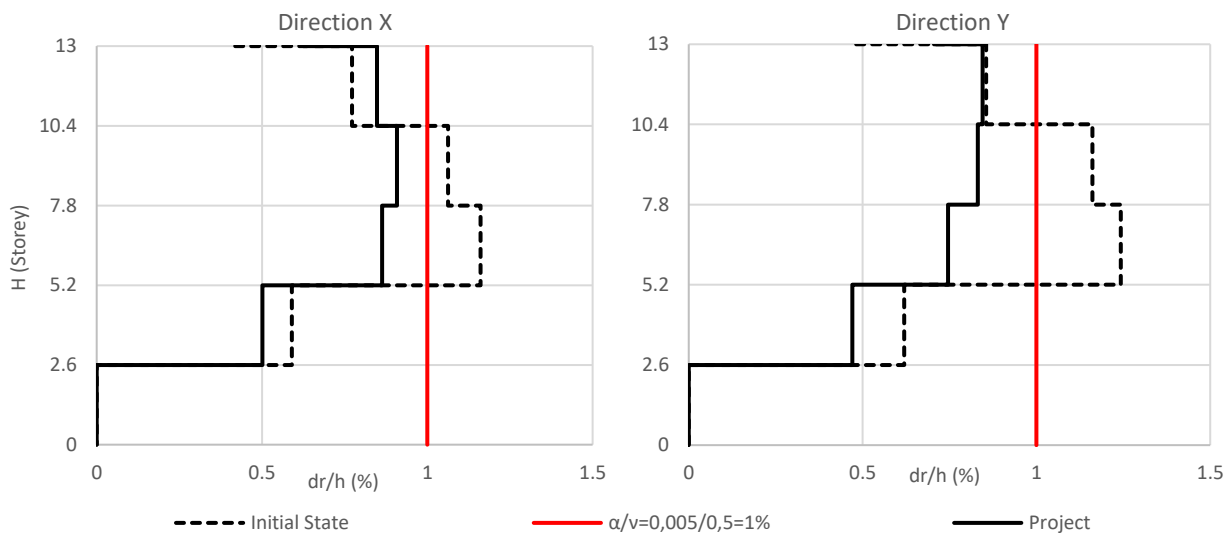

Figure 196 – Interstorey drift verification for the initial and the project states of the Brasov MRF for both main directions as defined in [12]; the displacement of each storey is calculated from the centres of masses (CM)

The assessment shown in Figure 196 quantifies a seismic improvement at the LS DL, from 80% to 118% in the transverse direction (Y) and from 86% to 110%, considering the longitudinal one (X).

$$E(a_g)_{LS DL} = 110\%$$

Verifications of the exoskeleton

The verifications of the external timber structure were carried out for ultimate limit state combinations (ULS and LS SD) and for operational limits (SLS and LS SD). The stresses resulting from the ULS and LS SD combinations were verified for each CLT panel (slabs and walls) by referring to [161] for the determination of the internal stresses and to Eurocodes [12, 132] for the verifications.

As mentioned in previous paragraphs, two different models, differentiated by the linear stiffness assigned to the rotational springs representing the PT-CLT connections, were developed to determine the stresses arising from the vertical (ULS and SLS) and horizontal loads (LS DL and LS SD).

From Eurocode 5 [132], with reference to glued laminated timber elements (CLT members), it is possible to determine:

- the partial factor $\gamma_M = 1.25$;
- the load-duration classes, set as instantaneous for seismic loads and permanent for vertical loads; which implies $k_{mod,HL} = 1.1$ and $k_{mod,VL} = 0.6$ for horizontal and vertical loads respectively;
- the service class, set to 2; which implies $k_{def} = 0.8$;
- the design value of material properties as $X_d = k_{mod} \frac{X_k}{\gamma_M}$, with X_k representing the characteristics values (reference to Table 152);
- the time-dependent wood properties as $E_{mean,fin} = \frac{E_{mean}}{(1+k_{def})}$, considering the influence of load-duration and moisture on deformations.

As conservative measures:

- the behaviour factor, considered to reduce stresses due to horizontal loads, is set at 1.5 for all the verifications concerning CLT elements at LS SD;
- the capacity of the PT-CLT connection, which depends on the amount of tension force provided by the steel strands, was reduced by considering 30% losses in the tendon force due to thermal deformation, tendon relaxation and the anchor slippage, as indicated in [169, 176, 177]; furthermore, the prestress imputed in the CLT-slabs was kept at the maximum value (500 kN/m), in order to not underestimate possible instability of the prestressed slabs.

Verifications of the CLT elements

With reference to [161] the stiffness matrix of the CLT elements for the walls and slabs was obtained (Table 168). From the FEM, section cuts were created for walls and slabs of the long and the short side extensions (Figure 198). Two cross-sections (top and bottom) were considered for CLT walls at each floor, while three cross-sections were provided for the slabs (two ends and in the middle). Considering the symmetry of the model, half of the timber elements were checked on two of the four sides.

The section-cuts created by the software provided resultant forces for all created cross-sections, calculated with respect to the barycentric axis, which affects the shell layered elements in the linear analyses. These forces were then distributed along the section and the timber layers, obtaining the internal stresses to be verified with respect to the design strength values.

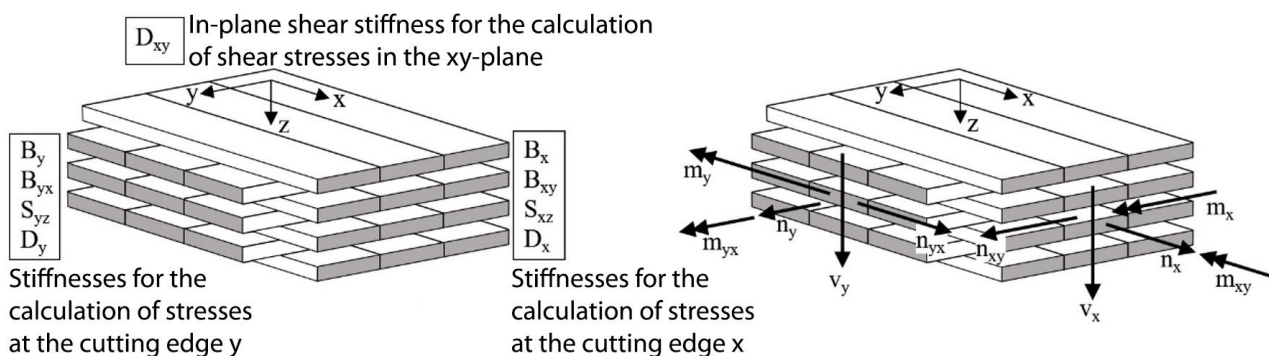

Figure 197 – Definition of stiffnesses and internal forces for CLT elements – Source: [161]

with

- B_x, B_y - bending stiffness in x- and y-direction
- B_{xy} - torsional stiffness
- S_{xz}, S_{yz} - shear stiffness in x- and y-direction
- D_x, D_y - axial stiffness in x-and y-direction
- D_{xy} - shear in-plane stiffness

Table 168 – Stiffness matrix of the CLT elements provided for the timber-based exoskeleton, the values refer to 1 m depth

CLT elements – Wall panels [162]												
CLT – Walls	B_x	=	8.01	0	0	0	0	0	0	0	MNm ² /m	
	B_y		0	2.42	0	0	0	0	0	0	MNm ² /m	
Thickness – 200 mm	B_{xy}		0	0	1.13	0	0	0	0	0	MNm ² /m	
	S_{xz}		0	0	0	49.18	0	0	0	0	MN/m	
Crossed layers – 40-40-40-40-40	S_{yz}		0	0	0	0	28.36	0	0	0	MN/m	
	D_x		0	0	0	0	0	1'852.00	0	0	MN/m	
Wood – Birch (Table 152)	D_y		0	0	0	0	0	0	1'278.00	0	MN/m	
	D_{xy}		0	0	0	0	0	0	0	170.00	MN/m	
CLT elements – Floor panels (ETA-06/0009 – EN 338)												
CLT – Floor slabs	B_x		=	3.66	0	0	0	0	0	0	0	MNm ² /m
	B_y			0	0.57	0	0	0	0	0	0	MNm ² /m
Thickness – 160 mm	B_{xy}	0		0	0.47	0	0	0	0	0	MNm ² /m	
	S_{xz}	0		0	0	2.19	0	0	0	0	MN/m	
Crossed layers – 40-20-40-20-40	S_{yz}	0		0	0	0	7.44	0	0	0	MN/m	
	D_x	0		0	0	0	0	1'456.00	0	0	MN/m	
Wood – Spruce (Table 152)	D_y	0		0	0	0	0	0	528.00	0	MN/m	
	D_{xy}	0		0	0	0	0	0	0	110.40	MN/m	

Based on the forces obtained from the section cuts, the following verifications were carried out (Tables 169-174). For the notations, reference is made to Figure 198 for the forces derived from the FEM, to [161] for the determination of the stresses, and to [132] for the verification formulae.

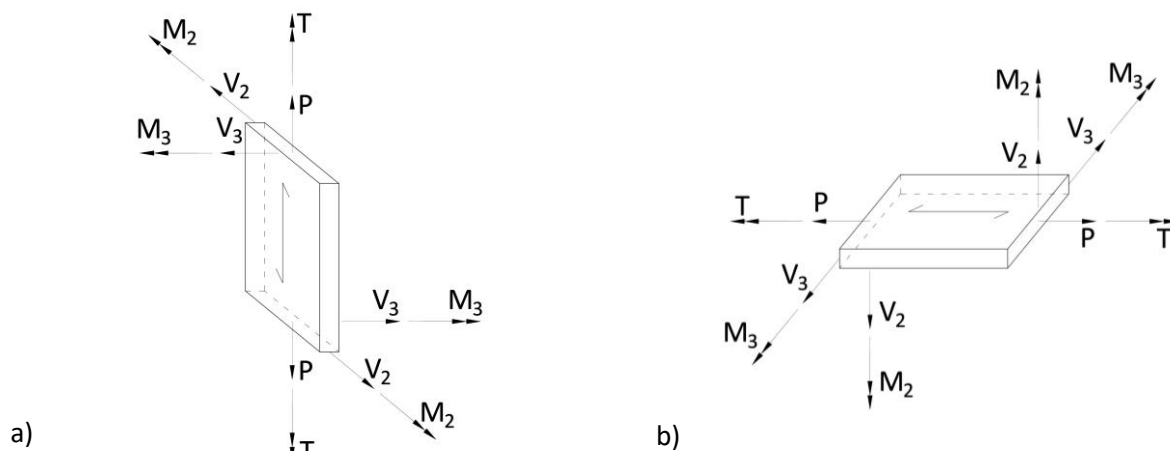

Figure 198 – Representations of the resultant forces from the section cuts of the FEM: a) walls; b) slabs

Table 169 – Formulas for the verification of compression (or tension) parallel to grain; B indicates the depth of the panels (set to 2 m for both, walls, and slabs)

Compression or tension parallel to grain (P)	
Application	Formulas
$E_{xx,i} = E_{0,mean}$ $n_x = \frac{P}{B}$	$\sigma_{x,i} = E_{xx,i} \cdot \frac{n_x}{D_x}$ (5.74)
	$\sigma_{x,i} \leq f_{(c,t),0,d} = \frac{f_{(c,t),0,k} \cdot k_{mod}}{\gamma_M} \cdot k_{sys,x}$ (5.75)
$E_{yy,i+1} = E_{90,mean}$ $n_x = \frac{P}{B}$	$\sigma_{x,i+1} = E_{yy,i+1} \cdot \frac{n_x}{D_x}$ (5.76)
	$\sigma_{x,i+1} \leq f_{(c,t),90,d} = \frac{f_{(c,t),90,k} \cdot k_{mod}}{\gamma_M} \cdot k_{sys,y}$ (5.77)

Table 170 – Formulas for the verification of bending moments without and combined with axial stresses; B indicates the depth of the panels (set to 2 m for both, walls, and slabs)

Bending (M2 for walls and M3 for slabs)	
Application	Formulas
$E_{xx,i} = E_{0,mean}$ $m_x = \frac{M2}{B}$ $z_x = \frac{s}{2}$	$\sigma_{x,i} = E_{xx,i} \cdot \frac{m_x}{B_x} \cdot z_x$ (5.78)
	$\sigma_{x,i} \leq f_{m,d} = \frac{f_{m,k} \cdot k_{mod}}{\gamma_M} \cdot k_{sys,x}$ (5.79)
$E_{yy,i+1} = E_{90,mean}$ $m_x = \frac{M2}{B}$ $z_y = \frac{s - 2d}{2}$	$\sigma_{x,i+1} = E_{yy,i+1} \cdot \frac{m_x}{B_x} \cdot z_y$ (5.80)
	$\sigma_{x,i+1} \leq f_{m,d} = \frac{f_{m,k} \cdot k_{mod}}{\gamma_M} \cdot k_{sys,y}$ (5.81)
Combined bending and axial stresses	
Formula	
	$\frac{\sigma_{(c,t),0,d}}{f_{(c,t),0,d}} + \frac{\sigma_{m,d}}{f_{m,d}} \leq 1$ (5.82)

Table 171 – Formulas for the verification of bending moments; B indicates the depth of the panels (set to 2 m for both, walls, and slabs)

Shear out-of-plane (V3 for walls and V2 for slabs)	
Application	Formulas
$E_{xx} \cdot S_{x,i} = \sum_{j=1}^i E_{xx,j} \cdot d_j \cdot z_j$ $v_x = \frac{V3}{B}$	$\tau_{xz,i} = \frac{E_{xx} \cdot S_{x,i}}{B_x} \cdot v_x$ (5.83)
	$\tau_{xz,i} \leq \min\left(\frac{f_{v,OP,k} \cdot k_{mod}}{\gamma_M}; \frac{f_{R,k} \cdot k_{mod}}{\gamma_M}\right)$ (5.84)

Table 172 – Formulas for the verification of in-plane shear; B indicates the depth of the panels (set to 2 m for both, walls, and slabs)

Shear in-plane (V2 for walls and V3 for slabs)	
Application	Formulas
$G_{xy,i} = G_{mean}$	$\tau_{xy,i} = G_{xy,i} \frac{n_{xy}}{D_{xy}} = \tau_0$ (5.85)
$n_{xy} = \frac{V2}{B}$	$2\tau_0 \leq \frac{f_{v,IP,k} \cdot k_{mod}}{\gamma_M}$ (5.86)
	$\tau_{T,d} = 3\tau_0 \frac{s}{B} \leq \frac{f_{T,k} \cdot k_{mod}}{\gamma_M}$ (5.87)

Table 173 – Formulas for the verification of torsion; B indicates the depth of the panels (set to 2 m for both, walls, and slabs)

Torsion (T)	
Application	Formulas
$G_{xy,i} = G_{mean}$ $m_{xy} = \frac{T}{B}$ $z = \frac{s}{2}$	$\tau_{xy,i} = \tau_{yx,i} = G_{xy,i} \frac{m_{xy}}{B_{xy}} \cdot z$ (5.88)
	$\tau_{xy} \leq \frac{f_{T,node,k} \cdot k_{mod}}{\gamma_M}$ (5.89)

Table 174 – Formulas for the stability verification of the members, considering the compression P and the moment M2 for the walls and M3 for the slabs; B indicates the depth of the panels (set to 2 m for both, walls, and slabs)

Stability	
Application	Formulas
$l_{0,walls} = 2h = 5 \text{ m}$ $l_{0,slabs} = l = 4 \text{ m}$	$\frac{\sigma_{c,0,d}}{k_{crit} \cdot f_{c,0,d}} + \frac{\sigma_{m,y,d}}{f_{m,y,d}} \leq 1$ (5.90)
$\lambda_{rel,c} = \frac{\lambda}{\pi} \sqrt{\frac{f_{c,0,k}}{E_{0.05}}}$ $\lambda = \frac{l_0}{\rho_{min}}$	$k_{crit,c} = \frac{1}{k + \sqrt{k^2 - \lambda_{rel,c}^2}}$ or $k_{crit,c} = 1$ se $\lambda_{rel,c} \leq 0.3$ (5.91)
$\rho_{min} = \sqrt{\frac{I_y}{A}} = \sqrt{\frac{s^2}{12}}$	$k = 0.5(1 + \beta_c(\lambda_{rel,c} - 0.3) + \lambda_{rel,c}^2)$ (5.92)

The verifications carried out on the CLT structural elements were satisfied for each section, except for some over-stressing on the ground floor walls and slabs due to torsional stresses, caused by the presence of the CLT front panels. The 100 mm thick CLT front panels are made of five layers (20-20-20-20-20 mm) of spruce-lamellae with holes for the windows and the main entrance of the building (Figure 199).

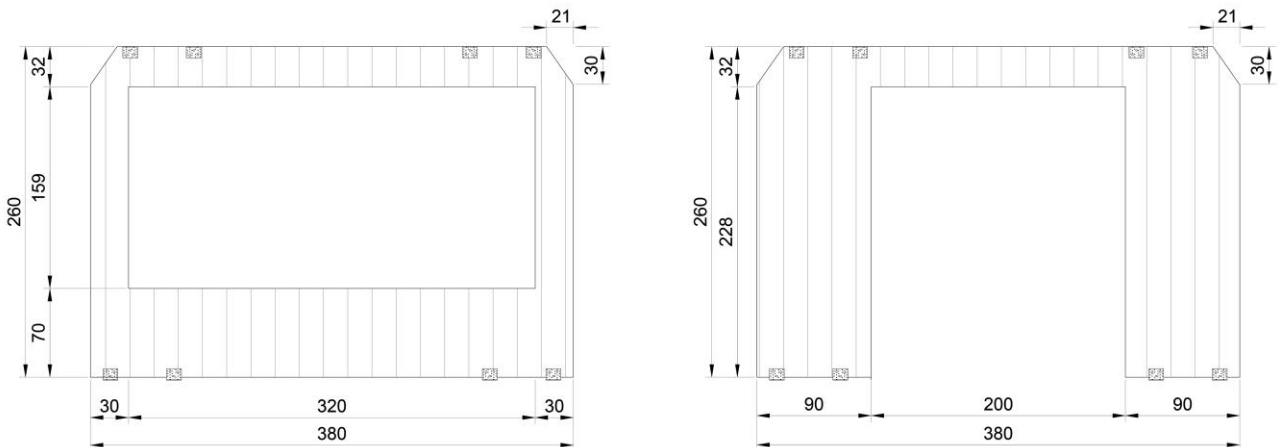

Figure 199 – Frontal CLT panels, provided at the ground floor to reduce longitudinal displacement and to separate the outside from the internal units

These panels were provided to reduce the displacement of the ground floor. In fact, the transversal walls are considered to be hinged at the foundation level, and although the rotation stiffness provided by the PT-connections is sufficient to ensure that the interstorey longitudinal drifts at the upper levels are satisfied, a bracing system was required at the ground floor. The panels provide this bracing for the ground floor and at the same time constitute an optimal architectural solution to delimit the external areas from the extended and renovated units. As a result, some torsional stresses are generated in the CLT transversal walls and slabs of the ground floor. This problem could be related to the prestressing phase of the slabs. The strong

compression affecting the slabs, in fact, implies deformations of the wooden exoskeleton which are counteracted by CLT panels (directly connected to the model) only in the front façades. The presence of these panels only on the external side generates torsional stresses in the timber structure (for walls and slabs of the ground floor) and could be addressed in two ways (the proposed solutions were not investigated):

- insertion of the front panels after the tensioning of the system, leaving tolerances between the panels to avoid torsional behaviour, but keeping their bracing function for larger displacement;
- provision of additional structural elements on the opposite (inner) side of the CLT extension, such as wooden beams to compensate for the presence of the CLT front walls.

These CLT elements have been verified directly in the FEM through visual checks (Figure 200) of the maximum internal stresses, affecting the shell element layers under seismic loading combinations (LS SD).

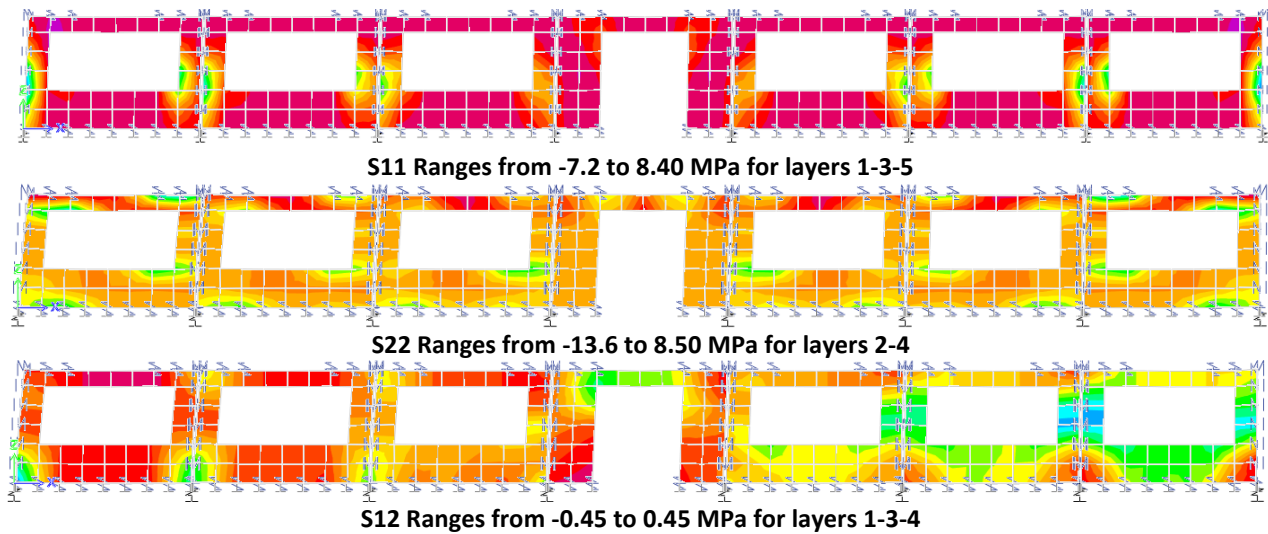

Figure 200 – Visualisation of the stresses affecting the layers of the frontal CLT panels; the pictures show the combination of LS SD, maximum combination in longitudinal direction, while the indicated ranges also consider the minimum combination in the same direction

For the serviceability limit state (SLS), a verification was made in terms of maximum deflection for the CLT slab with the largest span. Considering the first span in transverse direction of 6 m, the verification was made with reference to Eurocode 5 [132], also considering the requirements of a supported beam (Table 175). The maximum deflection was calculated, using FEM software and considering the elastic modulus (E) for the instantaneous deflection (w_{inst}) as well as a reduced modulus (E_{def}) for the creep deflection, taking $k_{def} = 0.8$.

Table 175 – SLS verification for deflection of the 6 m length CLT slabs – Source: [132]

Deflections		Requirements
$w_{inst} = 10.49 \text{ mm}$	$w_{inst} = 10.49 \text{ mm}$	$\frac{l}{500} = \frac{6'000}{500} = 12 \text{ mm}$
$w_{creep} = 7.23 \text{ mm}$	$w_{fin} = 17.72 \text{ mm}$	$\frac{l}{300} = \frac{6'000}{300} = 20 \text{ mm}$

Second order effects

With reference to Eurocode 8 [12], checks were made to determine whether or not second-order effects (P-Δ effects) need to be considered in the analysis. This check was made for the entire existing RC structure with CLT extension (Table 176) and for the CLT extension as an independent structure (Table 177). With reference to LS SD, the total seismic storey shear (V_{tot}), the interstorey drift (d_r) and the total gravity load (P_{tot}) were obtained. Also the inter-storey drift sensitivity coefficient (θ) was calculated and verified under 0.1 (5.93) for each storey.

$$\theta = \frac{P_{tot} \cdot d_r}{V_{tot} \cdot h} \leq 0.10 \quad (5.93)$$

Table 176 – Checks on the influence of second-order effects for the whole system (RC MRF plus CLT extension)

Level	P_{tot} (kN)	V_{tot} (kN)		d_r (CM)/h		θ	
		X	Y	X	Y	X	Y
Roof	3'060.814	961.724	992.823	0.004126	0.005404	0.01313	0.017198
4	6'985.844	1'808.785	2'031.921	0.005934	0.006839	0.022918	0.026415
3	10'910.87	2'385.152	2.78E+03	0.006657	0.006957	0.030452	0.031825
2	14'835.91	2'828.148	3'218.409	0.006535	0.006368	0.034279	0.033407
1	18'496.66	3'024.868	3'374.138	0.003792	0.003948	0.023188	0.024141

Table 177 – Checks on the influence of second-order effects for the independent CLT extension

Level	P_{tot} (kN)	V_{tot} (kN)		d_r (CM)/h		θ	
		X	Y	X	Y	X	Y
Roof	119.7316	37.0078	69.9986	0.001979	0.004097	0.006402	0.013256
4	289.879	80.4212	143.7597	0.003927	0.004037	0.014155	0.014551
3	460.0265	115.4736	1.94E+02	0.006087	0.003738	0.02425	0.014892
2	630.1739	143.3264	225.4198	0.00891	0.003112	0.039175	0.013681
1	800.3213	161.1647	240.7582	0.014461	0.00244	0.071809	0.012118

Connectors at foundation level and with the existing structure

Similarly, all forces affecting the connectors (hold-downs, angular brackets, PT-CLT connections and steel bars) were checked and found to meet the requirements. The only exception was related to some external hold-downs that would have required more nails, resulting in increased stiffness and an additional iteration of the design, not included in this study. Table 178 shows the maximum forces affecting the connectors and the strength capacities (both with 22 and 26 nails for the axial capacity of the hold-downs).

Table 178 – Maximum forces obtained with the linear dynamic analysis at the LS SD for the different components of the connectors: steel connecting rods ($\phi 12$), angular brackets (BMF116) and hold downs (HTT22); the capacities are reported considering k_{mod} of 1.1 and γ_m of 1.3

Value	Maximum design force (kN)	Capacities (kN)
$N_{\phi 12}$	55.00	61.07
V_{BMF116}	9.32	23.44
N_{BMF116}	7.98	21.62
N_{HTT22_22n}	47.11	46.54
N_{HTT22_26n}	-	55.00

The hold-downs located at the edges of the walls were also checked in the step of the pushover analyses corresponding to the LS SD. The implemented behavioural law (Figure 192) recorded the link displacement

for each step, allowing a direct control of the state of each HT22 and showing that none exceeded the displacement corresponding to the decrease in strength.

PT-CLT connection

Finally, the moment in the PT-CLT connection was verified, considering the LS SD and ULS combinations for horizontal (HL) and vertical loading (VL) respectively.

The maximum moment affecting a single rotational spring was obtained and multiplied by the total number of springs present to the edge of a panel (5) to obtain the maximum moment affecting the whole connection and then divided by two, in order to consider 1 m depth with a single steel strand (Figure 184). The verification of the connection also considered a 30% reduction of the tendon forces due to the time-dependent losses (thermal deformations, tendon relaxation and anchor slippage).

The PT connection resulted verified when:

- the maximum moment remained within the maximum capacity of the connection;
- the resultant compression perpendicular to the grain at the edges of the interface between the steel plates and the CLT walls was below the strength limit;
- the resulting compression perpendicular to grain, resulting at the interface between CLT slabs and the steel angular plates, was less than the design limit for the LVL (Figure 185);
- the steel tubes welded to the composed connection plate withstand the shear loads resulting from the horizontal slabs.

Figures 201 and 202 show the verification of moment and compression perpendicular to the grain for the PT-CLT connection with a tendon force loss of 30% (350 kN out of 500 kN). The same verification was done for the full tendon force with similar results.

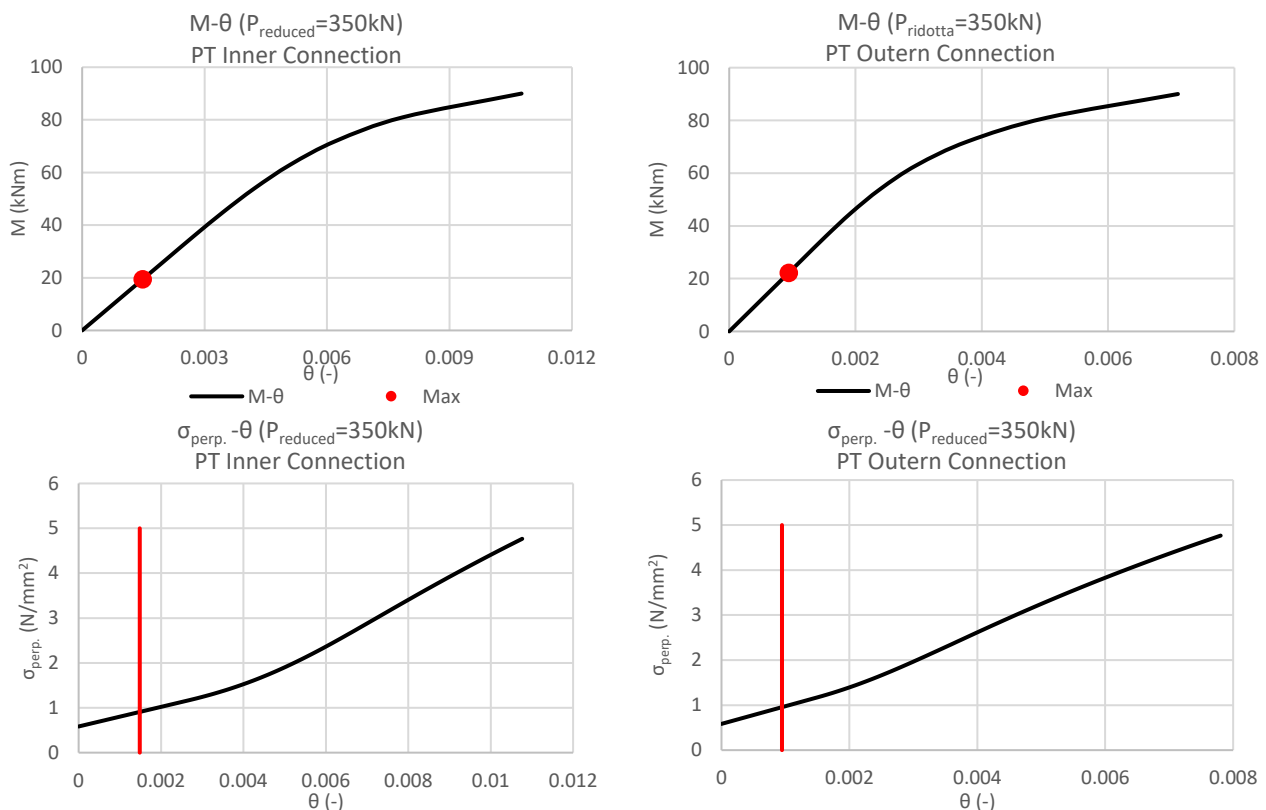

Figure 201 – Verification of the PT-CLT connection for inner and outer joints for the LS SD combination and therefore considering the case for horizontal loads; the maximum moments are represented together with the relative compression perpendicular to the grain at the edge of the interface

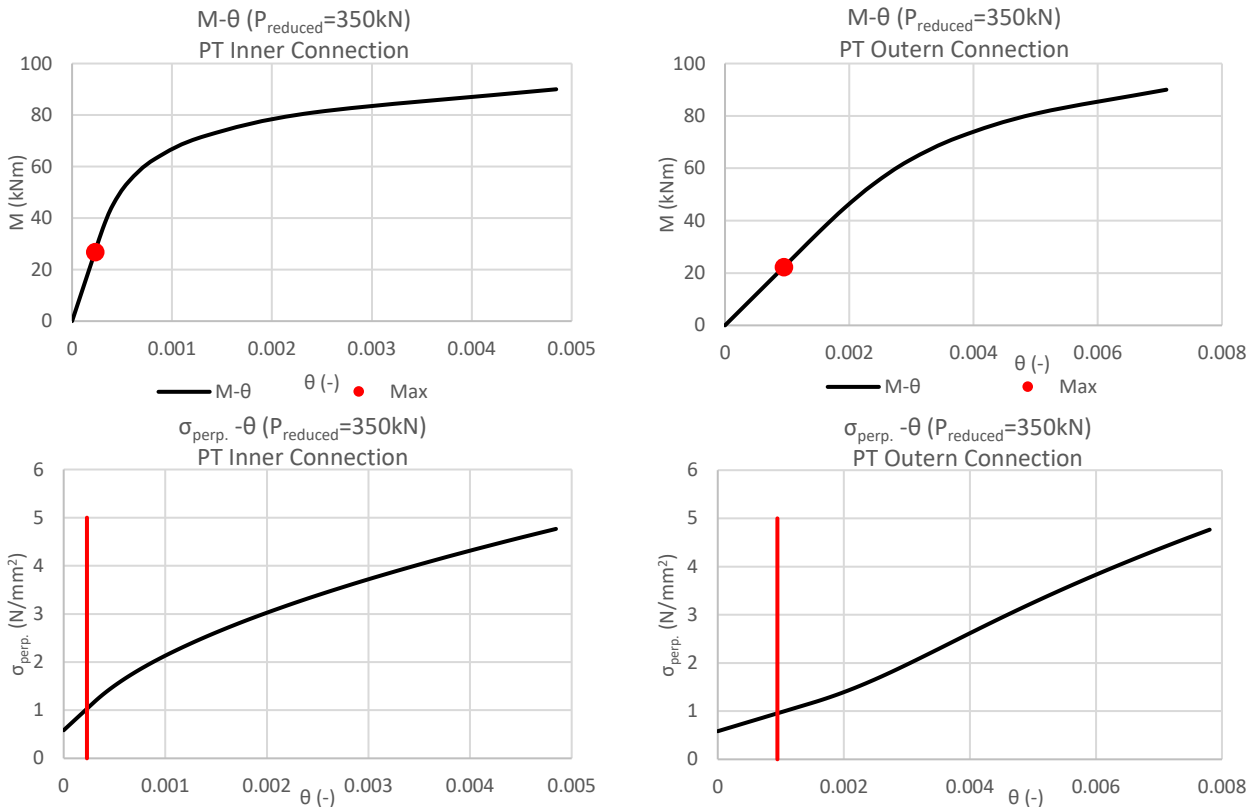

Figure 202 – Verification of the PT-CLT connection for inner and outer joints for the ULS combination and therefore considering the case for vertical loads; the maximum moments are represented together with the relative compression perpendicular to the grain at the edge of the interface

Considering the maximum moment $M = 26.793 \text{ kN}$, with (5.63), (5.64) and (5.65), it was possible to evaluate the maximum compression perpendicular to the grain on the LVL reinforcement (or hardwood lamellae) provided on the horizontal member.

$$\sigma_{perp,LVL} = \frac{2V}{d_{st} \cdot b_b} = 3.812 \text{ MPa} \leq 9.216 \text{ MPa} = f_{c,90,d,LVL} = \frac{f_{c,90,k,LVL} \cdot 0.6}{1.25}$$

Finally, considering the double maximum shear $2T = 93.47 \text{ kN}$, affecting the ends of the CLT slabs for both ULS and LS SD, the four steel tubes provided as shear keys for the steel composed plate were verified. The pipes were designed to fit one into the other, considering two adjacent steel composed plates with different cross-sections. Four identical pipes with the smallest dimensions ($\Phi 48.3 \times 2.6 \text{ mm}$) were considered for the verifications.

Table 179 – Verification of the steel shear keys welded to the composed plates of the PT-CLT connection

Scheme	Formulas
	$\tau_{zy} = \frac{4T}{3A} \frac{(R_e^2 + R_e R_i + R_i^2)}{(R_e^2 + R_i^2)} \tag{5.93}$
	$\frac{\tau_{zy,max} \cdot \sqrt{3} \cdot \gamma_{m,s}}{f_{y,S275}} = \frac{125 \cdot \sqrt{3} \cdot 1.05}{275} = 0.83 \leq 1 \tag{5.94}$

Non-linear static analysis (pushover)

The reference parameters described in Section 5.3.2.4 have been reported also for the project state.

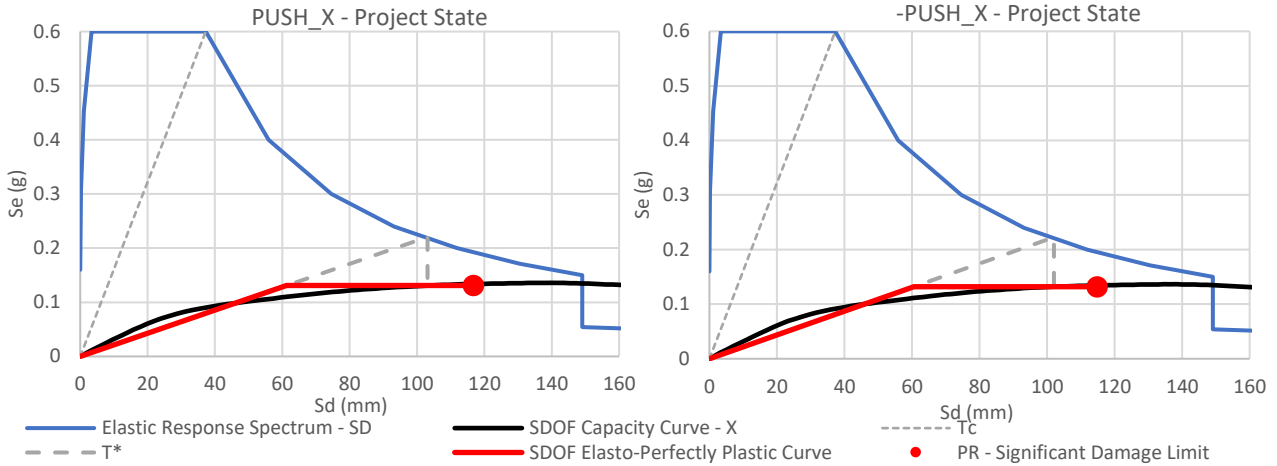

Figure 203 – Pseudo-acceleration and displacement elastic response spectrum (0.2 g), SDOF capacity curves with relative elasto-perfectly plastic curves and indicating displacement capacities; through T^* and the elastic response spectrum the demanded displacements are also graphically identified; uniform distribution along X-direction

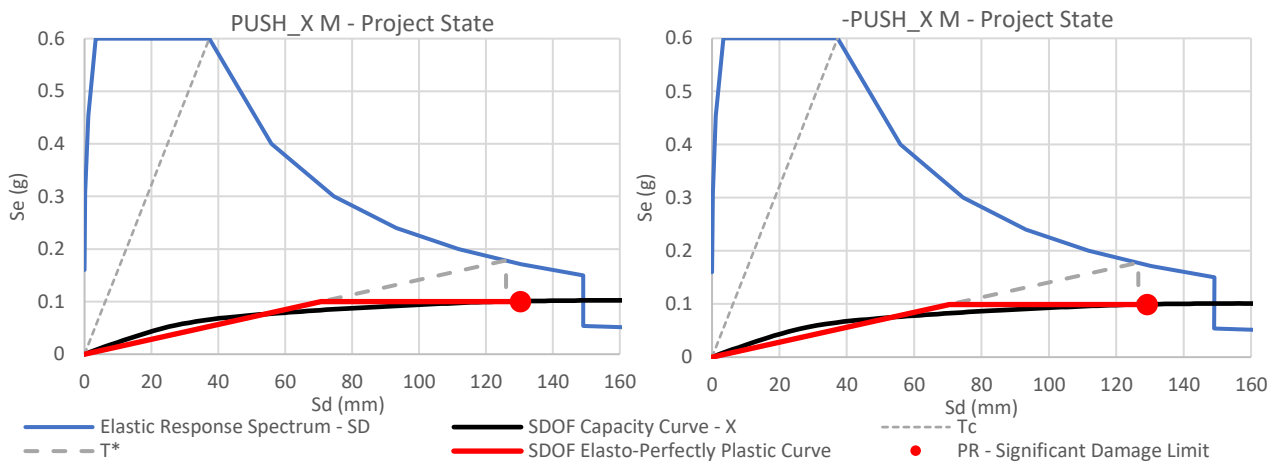

Figure 204 – Pseudo-acceleration and displacement elastic response spectrum (0.2 g), SDOF capacity curves with relative elasto-perfectly plastic curves and indicating displacement capacities; through T^* and the elastic response spectrum the demanded displacements are also graphically identified; modal distribution along X-direction

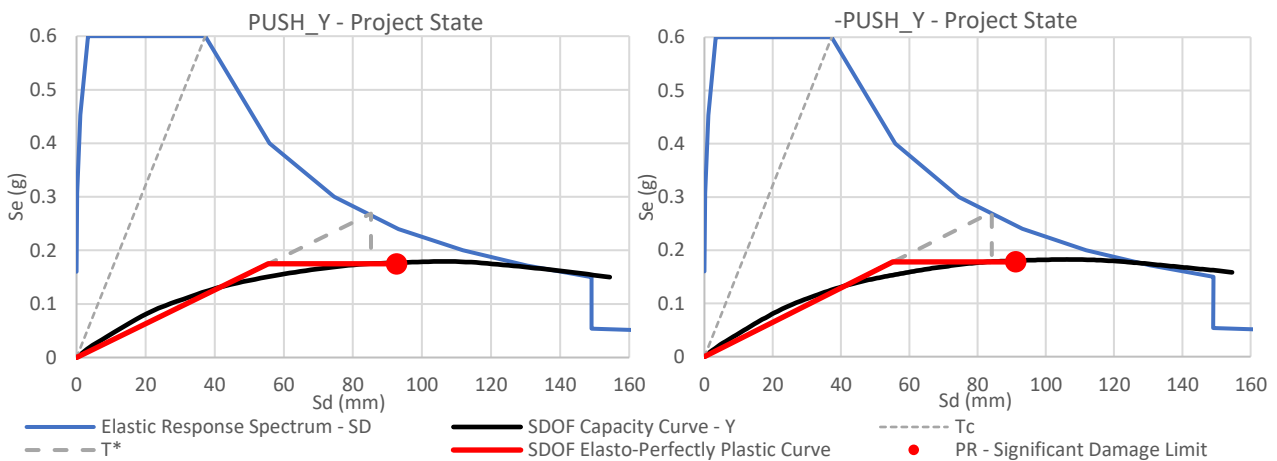

Figure 205 – Pseudo-acceleration and displacement elastic response spectrum (0.2 g), SDOF capacity curves with relative elasto-perfectly plastic curves and indicating displacement capacities; through T^* and the elastic response spectrum the demanded displacements are also graphically identified; uniform distribution along Y-direction

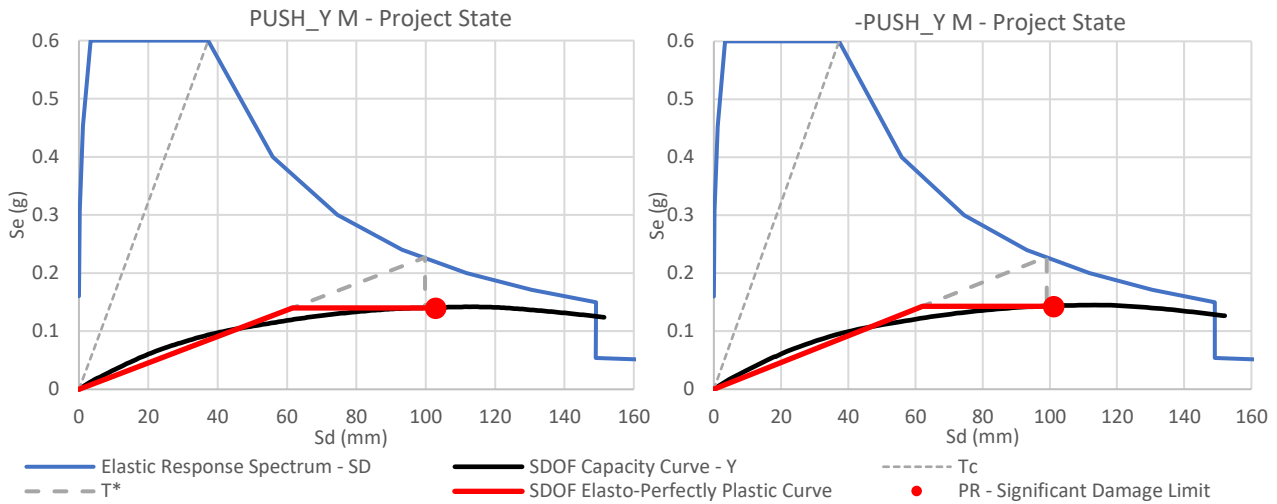

Figure 206 – Pseudo-acceleration and displacement elastic response spectrum (0.2 g), SDOF capacity curves with relative elasto-perfectly plastic curves and indicating displacement capacities; through T^* and the elastic response spectrum the demanded displacements are also graphically identified; modal distribution along Y-direction

Table 180 – Target displacement verification (TDV) for the significant damage performance level (LS SD), $TR = 475$ years, $PV = 10\%$ in 50 years; capacities and demands are expressed in mm of the control points and related base shear values (kN) for the analyses that regard the project state; the letter M indicates the analyses done with lateral load distribution proportional to the main vibration modes

Analysis	Capacity Shear (kN)	Demand Shear (kN)	Capacity Displ. (mm)	Demand Displ. (mm)	TDV – C/D (%)	$K_{LS DL}$ (kN/m)
PUSH_X	4'227	4'142	129.3	114.3	113	87'260
-PUSH_X	4'255	4'184	127.3	113.1	113	86'816
PUSH_X M	3'109	3'091	143.8	139.1	103	60'080
-PUSH_X M	3'053	3'042	142.5	139.7	102	59'894
PUSH_Y	5'337	5'273	119.9	110.4	109	85'569
-PUSH_Y	5'438	5'373	118.1	109.0	108	87'338
PUSH_Y M	4'204	4'186	135.2	131.3	103	63'151
-PUSH_Y M	4'192	4'276	131.7	130.3	101	64'879

Considering the elastic response spectrum introduced in the previous section, it was possible to evaluate the C/D ratio for all the combinations evaluated (Table 180). Fulfilling a verification indicates that the seismic capacity of the strengthened structure complies with the seismic demand deriving from the design horizontal loads.

5.3.3.6 Result comparison

Non-linear static analysis – result comparison

In order to evaluate the strengthening intervention by means of external timber shear walls applied perpendicularly to the existing façades, the set of parameters introduced in Section 5.3.2.4 was compared before and after the application of the exoskeleton.

- As mentioned above, an increase of the q-factors in both directions was recorded due to a better distribution of the damage along the height of the existing structure. While for the longitudinal direction (X) the behaviour factor passed from 2.90 to 3.63, in the transverse direction (Y) the improvement, in terms of possible force reduction, was recorded from 2.67 to 2.90. This fact is particularly evident from Figure 209 where the different deformed shapes of the existing structure before and after the application of the CLT walls can be seen. A better distribution of the damage

along the whole height of the building allows greater displacement capacities, dissipating more energy, and reducing damages concentrated in the lower floors. The increased displacement capacity is also visible from the capacity curves presented in Figures 210 and 211.

- The TDVs were performed with reference to Annex B of [12]. The capacity/demand ratios (C/D) indicate the seismic vulnerability or the capacity to resist design loads, depending on whether the value is less or more than 100% respectively. The application of the wood-based exoskeleton allowed to pass from 62% to 101% in the transverse direction (Y), and from 66% to 102% in the longitudinal direction (X), considering the weakest horizontal load distribution and direction. In Figures 207 and 208 two comparisons between initial and project state are shown, displaying the capacity and demand values for the modal distribution of forces in both directions (positive signs).
- Considering the results of the worst-case configuration (modal), the stiffness of the structure increased from 50'818 kN/m to 59'894 kN/m (Δ_{increase} of 1.18) in the longitudinal direction and from 42'903 kN/m to 63'151 kN/m ($\Delta_{\text{inc.}}$ of 1.47) in the transverse direction for the timber-based project solution. The different increase is due to a greater number of CLT walls, placed along the longitudinal direction with an increase in the seismic response for the transverse direction (Y).

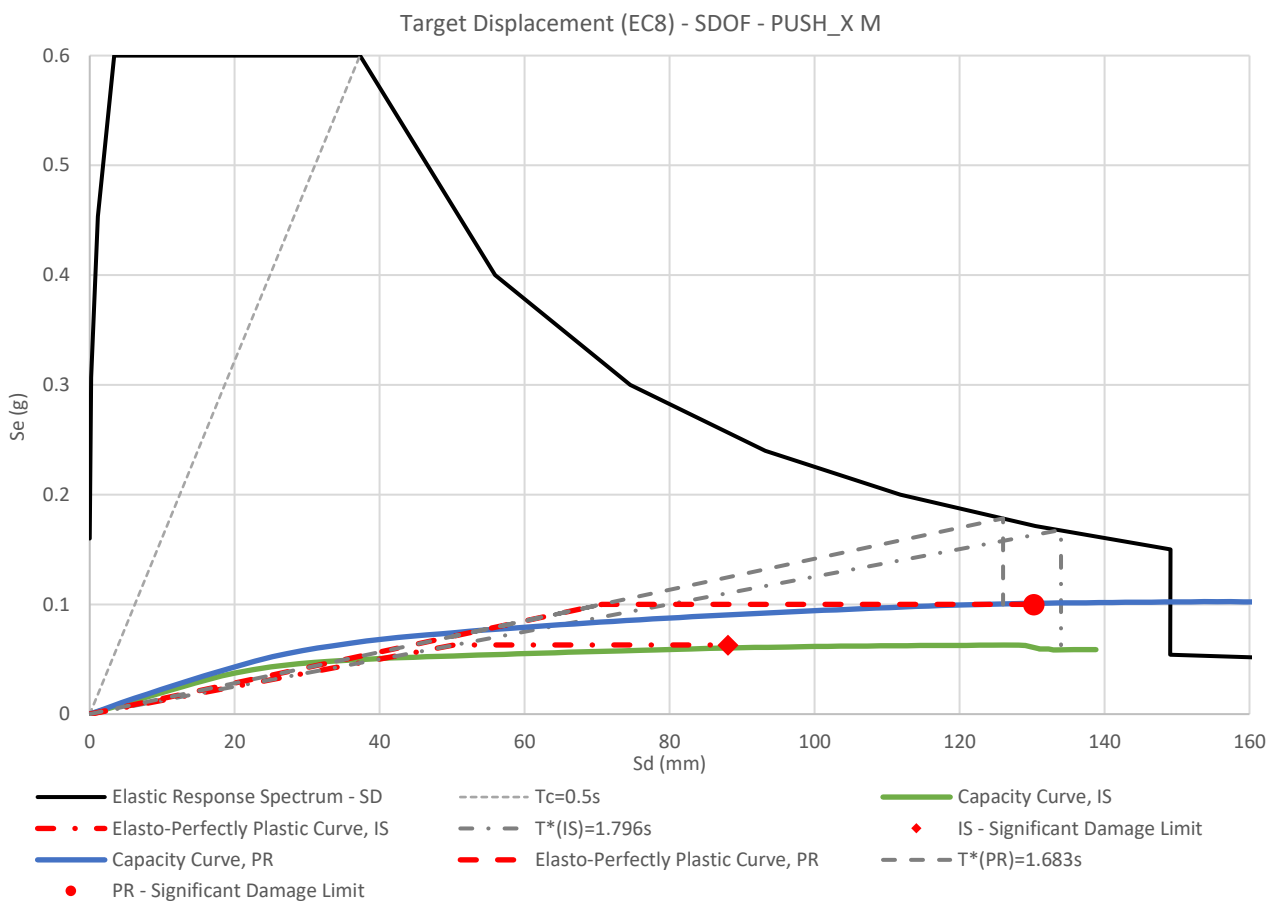

Figure 207 – Pseudo-acceleration and displacement elastic response spectrum (0.2 g), SDOF capacity curves with relative elasto-perfectly plastic curves and indicating displacement capacities, period values; through T^* and the elastic response spectrum the demanded displacements are also defined; comparison between initial and project states

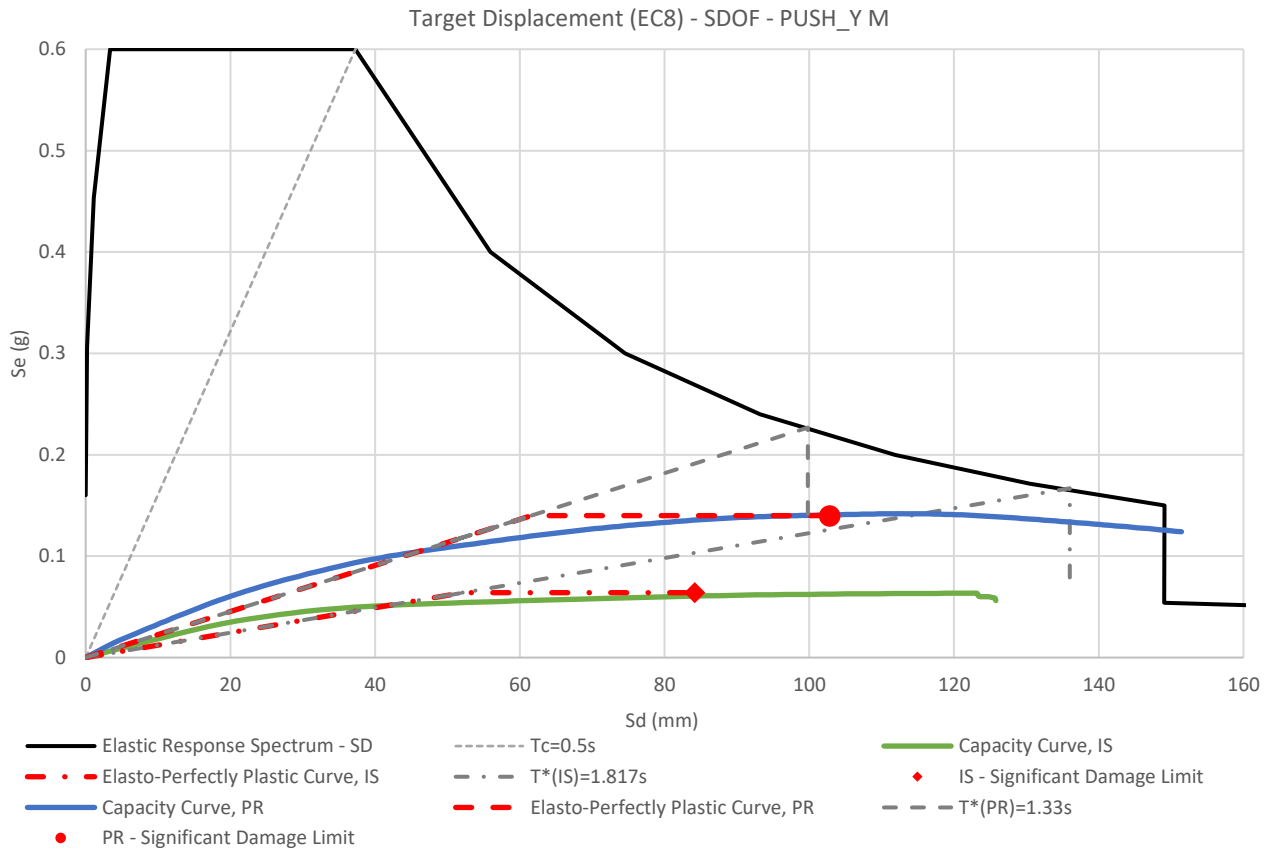

Figure 208 – Pseudo-acceleration and displacement elastic response spectrum (0.2 g), SDOF capacity curves with relative elasto-perfectly plastic curves and indicating displacement capacities, period values; through T^* and the elastic response spectrum the demanded displacements are also defined; comparison between initial and project states



Figure 209 – Deformed shapes at the LS NC obtained from the pushover analyses, performed in transverse direction before and after the project application; the coloured points represent the status of the plastic hinges passing from LS DL to LS NC

Exploitation of the exoskeleton

Finally, in order to measure the exploitation of the external structure, the amounts of horizontal force taken by both RC and CLT structures were registered from the pushover analyses at the LS SD step (Table 181) showing a margin of improvement of the system that could be explored in further steps by varying the base connection system.

Table 181 – Exploitation of the exoskeleton in terms of horizontal forces; calculated at the steps of the pushover analysis corresponding to the LS SD with modal force distribution for the timber-based project solution

Brasov MRF case study – Project solution				
Analysis	Total Shear (kN)	Existing Structure (kN)	Steel Exoskeleton (kN)	Exploitation (%)
PUSH_X	4'145	2'597	1'548	37%
PUSH_X M	3'108	2'573	535	17%
PUSH_Y	5'284	3'292	1'991	38%
PUSH_Y M	4'204	3'253	951	23%

The horizontal forces deriving from the capacity curves at LS SD, indicated that globally the CLT walls take from 17% to 38% from the total amount, showing room for improvement and further steps. To increase the overall stiffness and participation of the timber-based exoskeleton, the insertion of prestressed steel cables within the CLT wall layers (vertically) could be investigated [178, 179]. Increased stiffness at the foundation interface between CLT walls and concrete could be provided by exploiting rocking mechanisms, with a consequent reduction of connectors (hold-downs and angular brackets).

In addition, the insertion of dissipative devices at the level of the connections with the existing structure could decrease the overall seismic demand. The current selection of connectors was, in fact, intended to minimise the variables in the numerical analyses.

Capacity curves comparison

The capacity curves obtained through the non-linear static analyses are shown below for both main directions. For each curve, the coordinates corresponding to the exceedance of the SD limit states are also shown. The capacity curves in Figures 210 and 211 show how the application of the timber-based extension leads to increased strength and stiffness, which results in higher C/D ratios, better performance against frequent earthquakes and increased displacement capacities due to a different deformed shape.

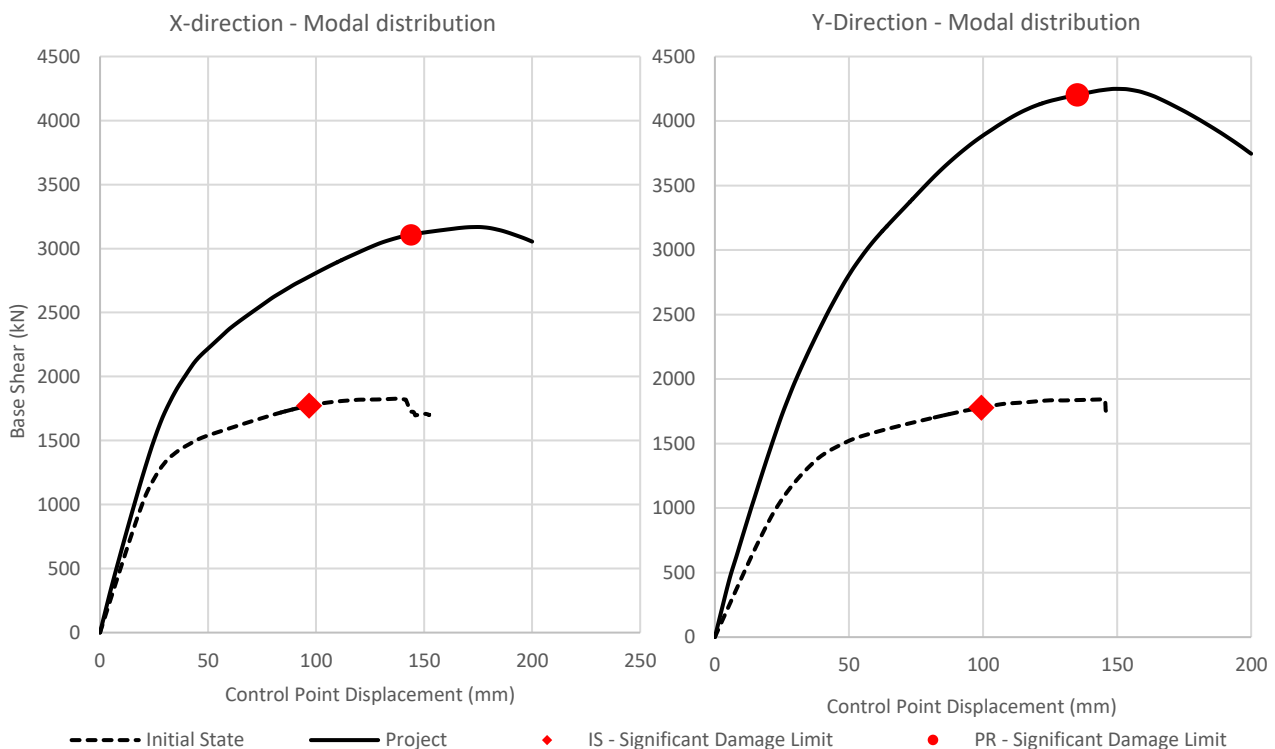

Figure 210 – Capacity curves obtained by pushover analyses with modal distribution of forces, in both main directions (positive signs), before and after the application of the exoskeleton

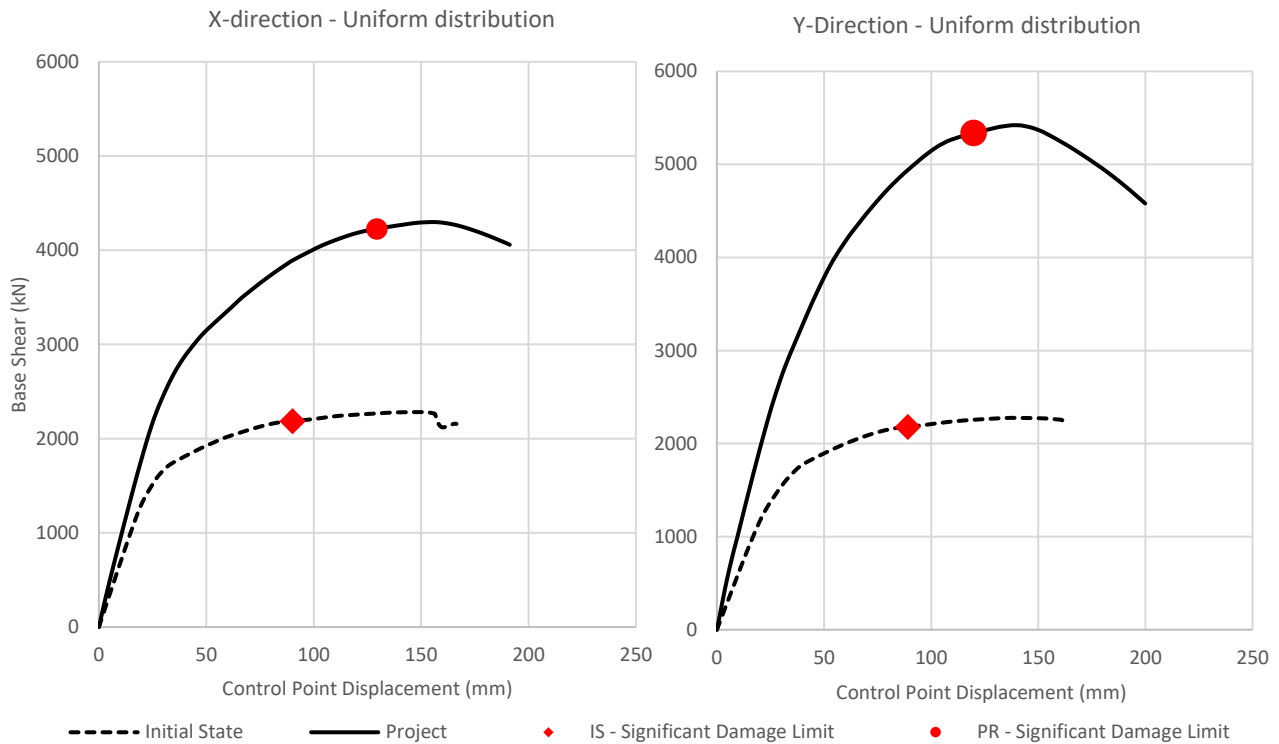

Figure 211 – Capacity curves obtained by pushover analyses with uniform distribution of forces, in both main directions (positive signs), before and after the application of the exoskeleton

The structure in the initial state has a comparable behaviour in both directions, while due to the higher number of CLT walls applied along the longitudinal direction, the design state sees a higher stiffness and strength. In addition, an increased displacement capacity is recorded as result of the reduction of shear loads concentrated in the lower storeys.

The results of the analyses shown that the timber-based external structure could be comparable to a steel exoskeleton [97], satisfying the design requirements associated to the performance level of SD.

Further analysis is required to deepen the understanding on the dynamic behaviour of the strengthened structure due to its partially released connection to the existing RC structure. Further details related to numerical and experimental investigations must be provided to characterise this connection. Finally, further feasibility studies are needed to determine the range of possible applications of the timber-exoskeleton (and its boundaries).

6. Post-tensioned CLT connection

The CLT “bookshelf” introduced in the end of the previous chapter (Section 5.3.3) is composed by CLT vertical continuous panels, connected at each floor with CLT horizontal panels, constituting the floors of the additional system. In order to avoid the necessity of bracings in the longitudinal direction of the portals, and therefore to maintain architectural freedom in the distribution of technical solutions for the residential units, a post-tensioned (PT) connection between the panels is provided.

The analytical method adopted by Wanninger and Frangi [164, 165] for calculating the behaviour of the connection is adapted to the new solution, placing CLT members instead of glulam linear elements (beam/column system). This connection between CLT vertical and horizontal panels has never been used or tested before and could represent an innovative alternative to more consolidated connections for this specific structural system and similar structures.

The behaviour of CLT vertical walls is already present in literature, together with the use of connectors at the foundation level, such as angular brackets and hold-downs [115, 172, 173, 180]. Therefore, the need for validation of the connection with post-tensioning cables between CLT panels is evident.

The connection between the panels is composed by a vertical continuous CLT member (wall) and two horizontal ones (floors). The steel unbonded cable will pass through the horizontal elements along their development and across the vertical one. It is tensioned in order to prestress the system, increasing the rotational stiffness of the moment-resisting connection and providing a recentering behaviour.

In order to adapt the analytical model to this configuration it was necessary to introduce steel plates, enlarging the connecting interface between the bidimensional elements, changing the original setup. The validation of the behaviour of the PT-CLT connection guaranteed the accuracy of the analyses done so far.

6.1 State of the art

6.1.1 From Pres-Lam® to present days

As already introduced in Section 5.3.3.3, post-tensioned (PT) timber systems have been developed and tested since 2005 at the University of Canterbury [167] by adapting concepts and principles originally developed for precast concrete constructions [166]. The “Precast Seismic Structural Systems Research Program” (PRESSS) investigated different types of connections for precast concrete frames. One of these systems involved unbonded tendons and resulted in favourable seismic behaviour due to the ability to avoid residual deformations and minimise damage after earthquakes. A procedure called “monolithic beam analogy” was developed within the program to determine the behaviour of the PT connection [166]. The work of M. Priestley and A. Palermo towards the development of low-damage design of RC structures formed the basis for the adaptation of the method to timber subassemblies [167].

The Pres-Lam® system exploits the idea of accommodating seismic demand through controlled rocking between structural elements and tendon elongation, while ensuring recentering capability and energy dissipation. The latter is provided by introducing energy-dissipation devices (such as viscous or friction dampers) or mild steel components, creating a hybrid connection (Figure 212f). The moment-rotation response is shown qualitatively in Figure 212, where the different contributions of the PT hybrid connection are demonstrated. While M_{pt} , represented by a multilinear elastic diagram, is the post-tensioning contribution, the different hysteretic cycles are associated with the moment M_s , indicating the contribution of the damping devices. The resulting flag-shaped hysteretic response, denoted by $M_{pt} + M_s$, provides energy dissipations together with self-centring behaviour [167]. In this regard, a key design parameter, identified in [168], is the ratio of the moment due to the PT over the total moment (6.1).

$$\beta = \frac{M_{pt}}{M_{pt} + M_s} \tag{6.1}$$

The moment given by the PT must exceed the resistance offered by the damping devices ($\beta > 0.5$) to allow the connection to be recentred. A value of $\beta = 1$ means that no dissipation is provided in the system and typically, the optimal design scenarios provide value of β between 0.6 and 1. The decision whether or not to include dissipation devices in the connection depends on the entity of the seismic actions, since stronger earthquakes require stronger connections or reduced demands due to additional energy dissipation. Thus, dampers or mild steel elements also increase the moment capacity of the connection [168].

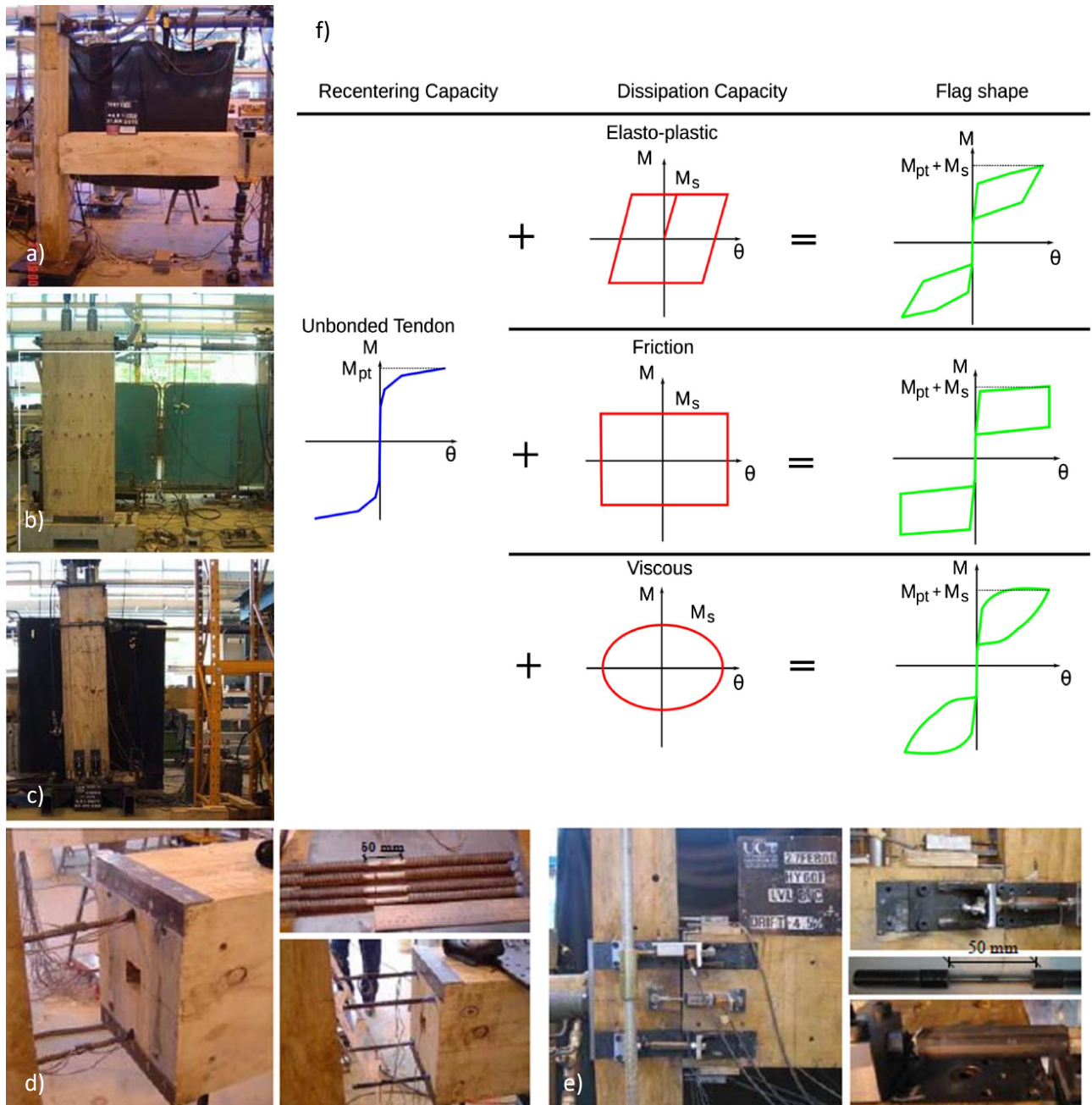

Figure 212 – PT test setup of: a) outer beam-column joint; b) wall-to-foundation connection; c) column-to-foundation connection; d) internal dissipators; e) external dissipators; f) idealised flag-shaped response of a post-tensioned rocking connection – Source: [167, 168]

The first series of tests using LVL (laminated veneer lumber) in beam-to-column or wall-to-foundation connections under vertical and horizontal loads was carried out in New Zealand giving rise to Pres-Lam®, and

aiming to present and disseminate an innovative, practical and more sustainable way to building with timber engineering products [167, 181-183]. A simplified analytical model for seismic analysis based on the monolithic beam analogy was then introduced [184], and a design framework was published (Figures 213a and 213b), investigating the local connections and the global response of the frame under seismic loading [185]. Other studies have focused on PT timber beams consisting of LVL box beams, including straight and draped tendon configuration and increasing the load carrying capacity of the elements, presenting numerical and analytical models [186, 187].

The feasibility study for the development of multi-storey timber PT buildings, considering details, costs and construction procedures, was then investigated [188], and subsequently constructed [189-191]. The three-storeys NMIT Arts & Media Building (Figures 213c and 213d), with its pairs of coupled LVL PT shear walls, represents the first example of prototypes of the technique at building scale. Further tests on the connection stiffness [179, 186], the advanced damping system [192] as well as the development of code provisions [183] and simplified design methods [193] have also been published.



Figure 213 – a) Isotropic view of the test building presented by M. P. Newcombe; b) photo of the test building presented by M. P. Newcombe; c) and d) photos during the construction of the NMIT Arts & Media Building – Source: [190, 194]

While research in the USA is aimed at the realisation of a tall recentering mass timber building called Framework [195], a more recent experience within the NHERI Tallwood project has led to the realisation of the first full-scale two-storey mass timber test building with PT rocking CLT walls on a shake table [196]. The result of the Framework building is still in progress and involves PT rocking CLT coupled walls as lateral load resisting system (Figures 214a and 214b). The development of multi-storey timber buildings has, in fact, become the critical point in the development of PT systems with current research focusing on CLT core

systems for tall buildings [197, 198], exploiting the increased stiffness conferred by the PT wall-to-foundation connection and investigating the variations of different connection diaphragms at floor levels, different CLT wall connection systems, different core shapes and the influence of dissipators. In addition, the advantages of multiple rocking segments for CLT and LVL PT wall systems were investigated [199].

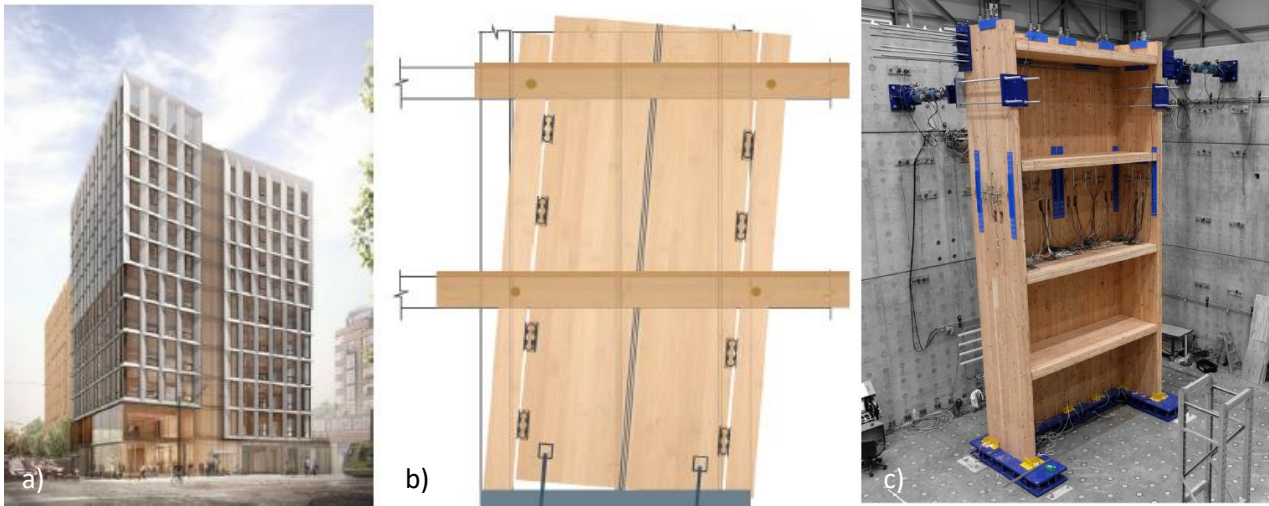

Figure 214 – a) Picture of the Framework building; b) scheme of the coupled PT-CLT walls provided for the Framework building; c) photo of the PT CLT C-shaped core investigated under seismic loading – Source: [195, 198]

Further research areas concerning PT systems address the interaction between PT frames and floor diaphragms [200], long-term behaviour [201, 202], monitoring and maintenance of buildings and fire resistance. While only a part of the available bibliography is mentioned here, reference is again made to [168] for a comprehensive review of research concerning PT timber structures. A specific paragraph is then dedicated to the research of ETH Zürich as a direct reference for the adaptation of the analytical model presented here.

6.1.2 The ETH Zurich experience

The potential of PT-timber structures has also been recognised by European research institutes, such as the ETH Zurich. In [164] a simplified design and modelling approach through applications on glue-laminated timber subassemblies is presented, which is more suited to the European market than LVL elements. Experimental tests were performed under both gravitational and horizontal loads [164, 165, 169], obtaining excellent structural performance and good accuracy of the analytical model. The authors were able to completely remove the steel components from the PT connection thanks to the use of hardwood layers at the beam-column interfaces. It was concluded that PT timber frames provide semi-rigid and moment-resisting structures without the need for additional metal fasteners, with difference from the Press-Lam® system. Consequently, the system has been shown to be particularly suitable for prefabrication, allowing fast and practical assembly processes on site and reducing construction costs [170].

6.1.2.1 Performance under gravity loads

The structural elements of the column-beam subassemblies examined consisted of glue-laminated timber made of spruce (GL24h), reinforced with hardwood lamellae (ash, D40) at the beam-column interfaces. Post-tensioning was provided by a single tendon inserted in the centre of the beams cross-section and crossing the column. Additional hardwood reinforcement was provided also at the lower edge of the beams, as shown in Figure 215.

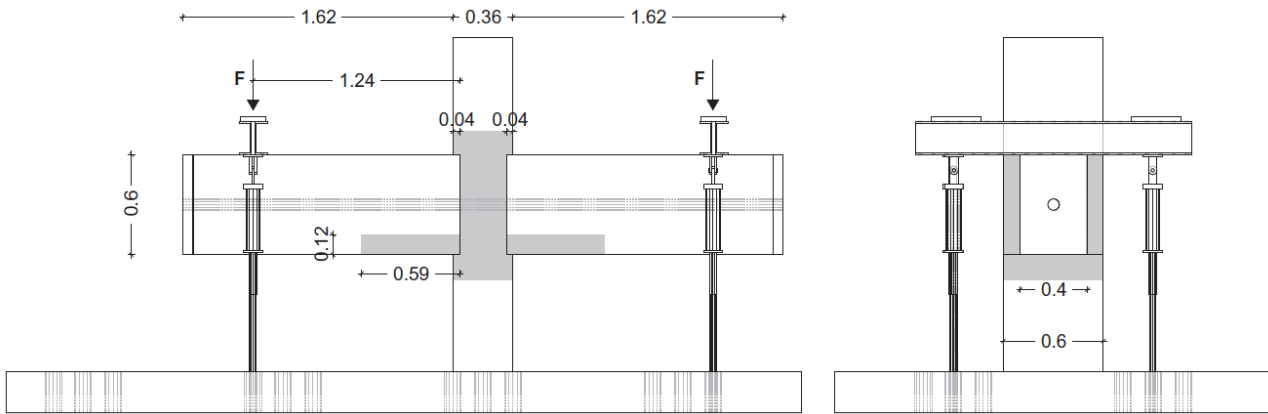

Figure 215 – Test set-up for a post-tensioned connection at ETH Zurich – Source: [164]

The tests were conducted with various forces applied on the beams in a symmetrical and asymmetrical manner, also varying the initial tendon force from 300 kN to 700 kN. Through the application of the forces on the beams, a moment was applied at the interface with the column, which was fixed with an external rigid frame. The prestressing provided by the force of the tendons put the beam-column interface in a state of compression. Through the application of the forces by the cylinders and the rotation of the beams, the interface starts to rotate, leading to a decompression of the connection zone and, ultimately, to a gap opening at the beam-column interface.

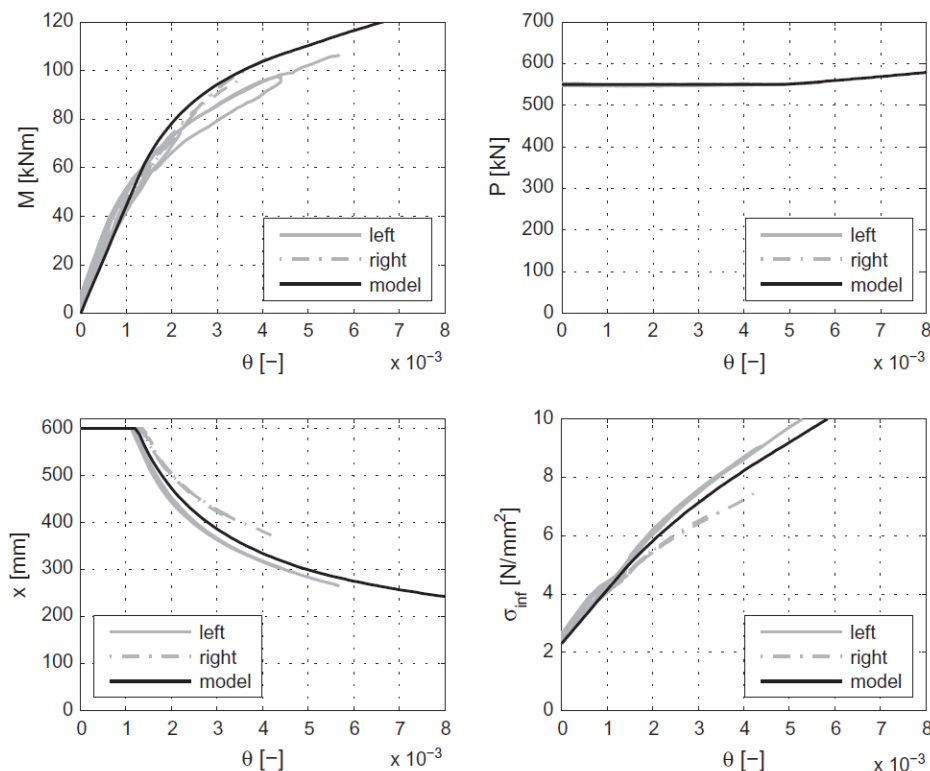

Figure 216 – Test without tendon elongation and comparison with model prediction – Source: [164]

The results of the extensive experimental analysis show that by using this column-beam subassemblies, it was possible to create a semi-rigid PT connection without the use of additional steel elements in the joint. Furthermore, the simplified model approach (presented in Section 6.2), led to good predictions of the connection behaviour for symmetric and asymmetric test results and thus considering the shear deformation in the joint panels.

Eventually, the strength perpendicular to the grain of the timber column was identified as the decisive design criterion for the connection, being the main failure mode that does not lead to brittle failures.

6.1.2.2 Performance under horizontal loads

A three-span post-tensioned timber structure with hardwood reinforcements was analysed with a series of pushover tests, recording the horizontal force in relation to the displacement (Figure 217b). The test results were compared with the calculations obtained using the analytical spring model (Figure 217c) with particular attention to the behaviour of the beam-column joints, where the different displacement contributions were studied (Figure 217a) [165].

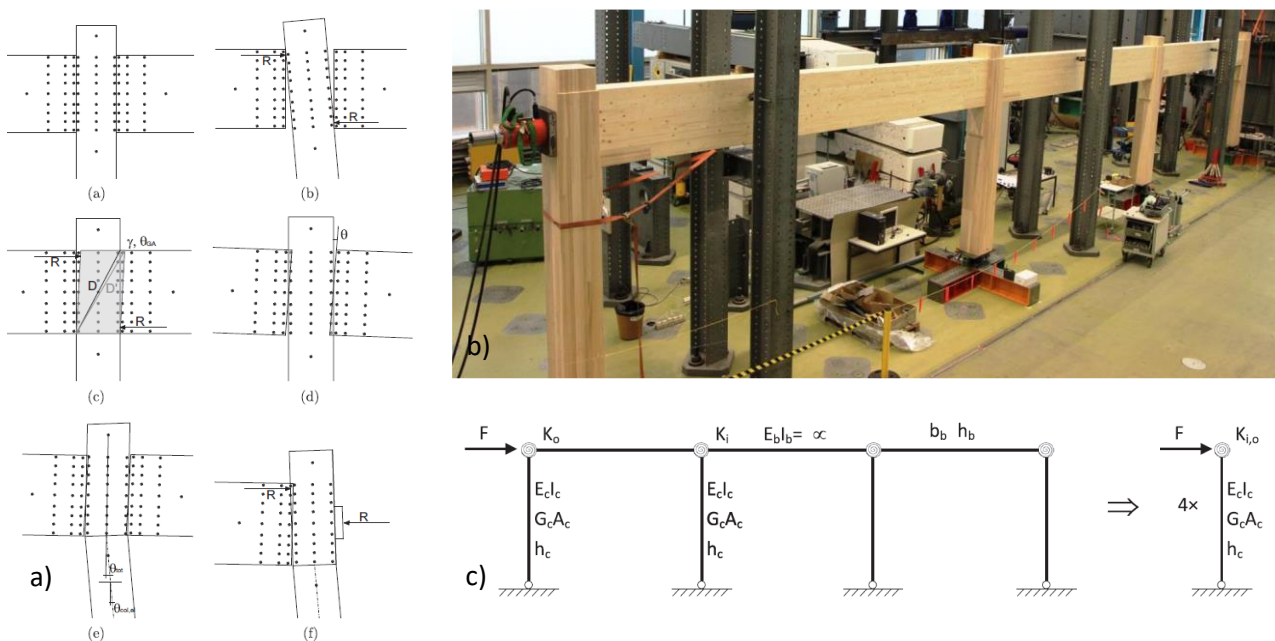

Figure 217 – a) LEDs on the specimen showing rigid motion, shear deformation, moment rotation and total deformation of the inner joint and an example of deformation for the outer node; b) three-bay PT timber frame for the pushover test at the ETH of Zurich; c) simplified system for the analytical calculation of the pushover curve – Source: [165]

The pushover-curves showed stiff behaviour for small deformations up to about 20 mm, decreasing in stiffness with larger displacements. The resulting behaviour is favourable, since the system is stiff for small displacements such as those occurring from wind loads or frequent earthquakes and softer for larger ones. This reduces the vulnerability to damages, ensuring a recentering behaviour, confirmed also for larger subassemblies (the frame was able to return to initial position after the load was removed at a drift level of 2.2%, corresponding to 65 mm). The analytical model was able to accurately predict the behaviour of the experiments under gravity loads, and reasonably well for pushover results with higher tendon force. However, a stiffer behaviour than measured was calculated for lower value of tendon forces.

6.1.2.3 Long-term behaviour

An important topic for the development of post-tensioned timber structures is their long-term behaviour, which is influenced by the time-dependent properties of wood. Deformation of structural components due to shrinkage and swelling, creep, or temperature strain leads to losses in the post-tensioning force which must be considered in the design process. In addition, steel tendon relaxation and anchorage slippage further influence the behaviour over time.

Several specimens of PT-beam and column-beam exposed to controlled and uncontrolled environmental conditions and loaded with axial prestressing force were monitored for more than one year

at ETH Zurich [177]. The prestressing loss was estimated to be in the range of 5-10% over that period, depending on the geometrical properties and the environmental conditions. Further considerations identified that at the end of a 50-year service life, this percentage is likely to increase to 30% [170].

6.1.2.4 Prototype design and final considerations

ETH Zurich PT timber system called Flexframe[®] was firstly implemented in a prototype building in 2015 [170]. The ETH House of Natural Resources is a four-storey building located on the ETH Höggerberg campus site. The basement and the ground floor were conventionally built in RC, while the top two storeys were built with the PT-system introduced above and providing wood-concrete composite floors [170]. The building is currently under monitoring. The frame system allowed a flexible distribution of the floor plans and a fast assembly process (the timber frame was built in a few days); thus, it can be loaded as soon as the tendon force is applied.

The 2-storeys frame has a height of 6 m (2 times 3 m) and consists of 3 spans of 6.5 m in both directions (Figure 218a). The beams have a cross section of 720×280 mm and are made of GL24h glulam, while the hardwood columns have a cross section of 380×380 mm and are of GL48h strength grade. A tendon force of 500 kN was chosen to meet the design requirements of the building, considering an initial tendon force of 700 kN to include approximately 30% losses. The displacement of the first storey was limited by the removal of the unfeasible pinned connection at the foundation level. Glued-in rods within the cross-section of the vertical elements and characterised by a moment-rotation behaviour implemented according to specific test results [170] were provided. These column bases added lateral stiffness to the frame, re-distributing the moments from the connections to the column bases.

Thanks to the lateral deformation capacity, the building can be constructed in seismic areas, since the controlled displacement of the PT frames prevent damage, ensuring a recentring behaviour.



Figure 218 – ETH House of Natural Resources: a) structural scheme of the two storey post-tensioned timber frame; b) photo of the office with post-tensioned timber frame – Source: [170]

6.2 The analytical model and its adaptation to CLT elements

The PT connections aim to provide ductility and energy dissipation by exploiting the rocking mechanism at the beam-column interface. The non-linearity of the structure is defined by the moment-rotation behaviour of the joints and not by the inelastic deformation of the structural members.

The monolithic beam analogy was developed by comparing the plastic deformation of a continuous system to an imposed rotation due to rocking motion of a prestressed system. The purpose of this type of connection is to provide inelastic behaviour during seismic event, keeping the structural members in its elastic range and avoiding residual deformation. The moment-rotation behaviour of the connection

determines the stiffness and strength of the PT structure. Therefore, the global displacements depend on the rotation of the PT connections and must be carefully defined to meet the requirements of the standards.

As described in Section 5.3.3.3, a lumped spring approach is used to implement the properties of the connection into a numerical model and to evaluate the seismic performance of the structure. Non-linear rotational springs are chosen to represent the moment-rotation behaviour of the PT-CLT elements [169, 194]. In the following chapter, the analytical model used to determine the properties of the rotational springs and to evaluate the test results is presented.

6.2.1 Existing analytical model

6.2.1.1 Simplified spring model

The analytical model adopted for the description of the behaviour of the PT-CLT connection is based on research developed at the ETH Zurich by F. Wanninger and A. Frangi [164, 169].

The model is based on a bedded foundation on springs; a concept known as Winkler foundation theory [203]. While the beam, which ends at the interface, behaves as a rigid body due to the higher strength and stiffness of the timber components in the direction parallel to grain, the softer column only withstands compressive forces and can be represented by a series of parallel springs. No dissipating elements are provided, and a gap occurs at the interface as soon as there is no compression at either the upper or lower edge of the connection.

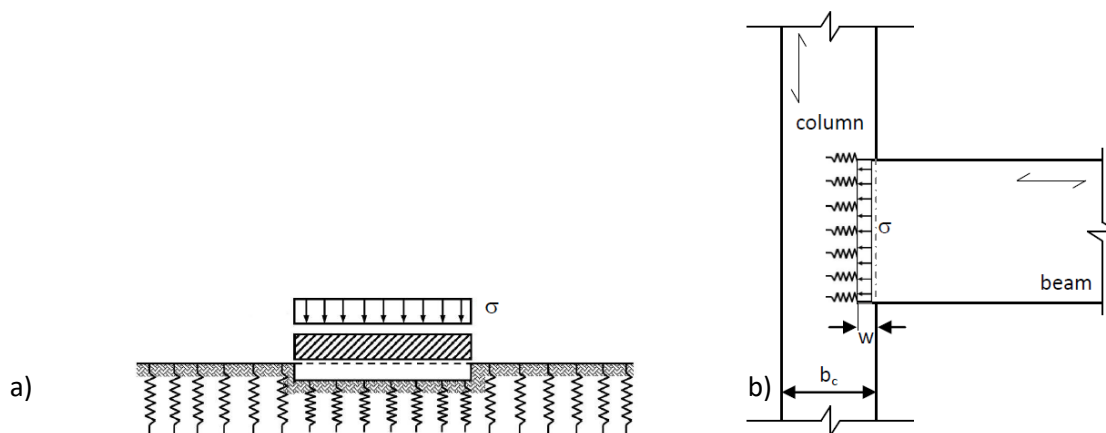

Figure 219 – a) foundation on elastic bedding; b) beam-column connection with simplified spring model – Source: [169]

The analogy, justified by the difference between the higher Young's modulus of wood in the direction parallel to the grain and that in the direction perpendicular to it, leads to the possibility of using a model called the trapezoidal stress method. This model makes it possible to derive the stresses under a foundation from the equilibrium condition, requiring only the modulus of subgrade reaction (c), obtained on the basis of the column properties [169]. Considering the symmetry and the simplified method (more accurate research on the determination of this modulus is presented in [204]), the following expression was used with reference to Figure 219b for notations.

$$c = \frac{\sigma}{w} = \frac{\sigma}{\frac{\sigma \cdot b_c}{2E_{90}}} = \frac{E_{90} \cdot 2}{b_c} \quad (6.2)$$

It is assumed that $E_{90} = E_{c,90}$, as described in [169]. The accuracy of modulus c has been studied in [204], indicating that, considering Young's modulus perpendicular to the grain, according to EN 338 [163] would lead to acceptable results. If values higher than E_{90} were taken for the tests, the above equation could lead

to an overestimation of the modulus c . The latter can be adjusted to obtain more accurate results through a distribution of the stresses in the column (6.3). Considering a linear distribution of stresses within the column depth and introducing Δ to characterise the degree of distribution, the modulus of subgrade reaction for this case can be calculated as follows [169].

$$c = \frac{\sigma_m}{w} = \frac{h_b}{h_b + \Delta \cdot \frac{b_c}{2}} = \frac{E_{90} \cdot 2}{b_c} \quad (6.3)$$

with

- h_b - beam height;
- b_c - column thickness;
- Δ - coefficient of distribution of stresses (set to 1 to consider 45°).

6.2.1.2 Equilibrium at the interface and determination of the rotational behaviour

The analytical model simply calculates the equilibrium between the forces acting at the interface between the horizontal and the vertical elements. The force of the tendon presses the beam against the column and as soon as the beam is loaded, a rotation begins that brings the edge to decompression and concentrates the stresses in the opposite one. As soon as the bending moment stresses reach the decompression limit, a gap opens, leading to the non-linear behaviour of the connection. The increase of loads in the horizontal elements implies an increase in the rotation, measurable by the depth of the neutral axis (x), which is progressively reduced. As soon as the neutral axis reaches the position of the tendon (centre of the beam), the opening leads to the elongation of the tendon and a consequent increase of the tendon force which results in an increase of the rotational stiffness of the connection. As introduced in Section 5.3.3.3, to calculate the behaviour of the PT-connection, three stages are defined, depending on the value of the neutral axis x [164, 169, 170].

The first stage (identified in Table 182 as before decompression) has the entire cross-section under compression ($x = h_b$). The equilibrium between the tendon force and the moment affecting the interface leads to the equations (6.4) to (6.6). As the value of the moment increases, the rotation increases linearly until the decompression moment (6.11) is reached and the stresses on the upper edge of the interface are zero.

From this moment on, the increase in rotation implies the opening of a gap, reducing depth of the neutral axis ($x < h_b$) and causing a reduction in stiffness (non-linear behaviour). Once again, thanks to the equilibrium of the forces at the interface, it is possible to determine the behaviour of the connection during this phase, obtaining the equations (6.12) to (6.15).

The third phase involves the elongation of the tendon ($x < h_b/2$) and occurs when the neutral axis goes below the position of the tendon. This elongation causes an increase in strength and stiffness. Within this stage, the equations (6.12) and (6.13) remain valid while the tendon force varies for each value of rotation (6.18). With the new value of P , determined with (6.19), an iterative process using the equations (6.12), (6.13) and (6.18) is done to determine the solution corresponding to each value of θ and consequently the final part of the connection behaviour.

When both horizontal elements are symmetrically loaded, the resultant force R has the same height at the interface (central Figure 222 referring to the CLT adaptation) and the behaviour of the column (compressed on both sides in the same way) is described by the modulus of elasticity perpendicular to the grain E_{90} . However, when the loads are asymmetrical, the structural behaviour is slightly different, since shear deformations occur in the vertical element due to the eccentricity of the resulting compressive forces affecting the two interfaces of the joint panel. This occurs in the outer joints, where only one beam is loaded on one side, resulting in an eccentricity $e = d - r$; and more significantly for the inner elements, where the horizontal loads could determine a doubled value of eccentricity $e = 2(d - r)$ as shown in Figure 222.

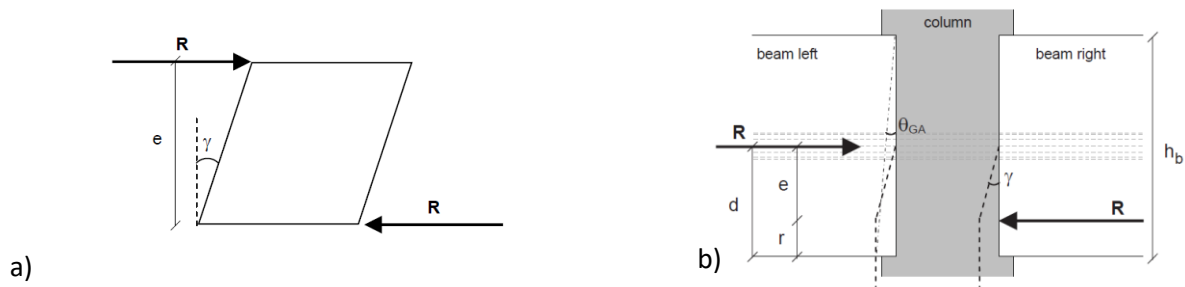

Figure 220 – a) Definition of the shear angle γ ; b) shear deformation of the column – Source: [164, 169]

A critical parameter for the definition of the PT connection is the compression perpendicular to the grain of the column. This critical value controls the possible rotation at the interface and can be used to identify the maximum applicable rotation (θ_{max}) and maximum moment (M_{max}) for the specimen, studied with (6.20) and (6.21) [164, 169].

$$\theta_{max} = \frac{f_{c,90,k}^2 \cdot b}{2 \cdot P_0 \cdot c} \tag{6.20}$$

$$M_{max} = P_0 \cdot \left(\frac{h_b}{2} - \sqrt{\frac{2}{9} \cdot \frac{P_0}{b \cdot c \cdot \vartheta_{max}}} \right) \tag{6.21}$$

Higher values of the tendon force increase the moment capacity of the connection while reducing the deformation available to failure of the grain. If the compressive strength perpendicular to the timber grain is exceeded, the failure of the connection consists in crushing of the timber, resulting in residual plastic deformation of the structural elements. Within LS DL, plastic deformations should be avoided to limit repair costs. However, in the case of LS SD or NC, plastic deformation of the timber may lead to energy dissipation, providing ductile mechanisms that do not compromise the stability of the system.

6.2.1 Adaptation of the analytical model to CLT panels

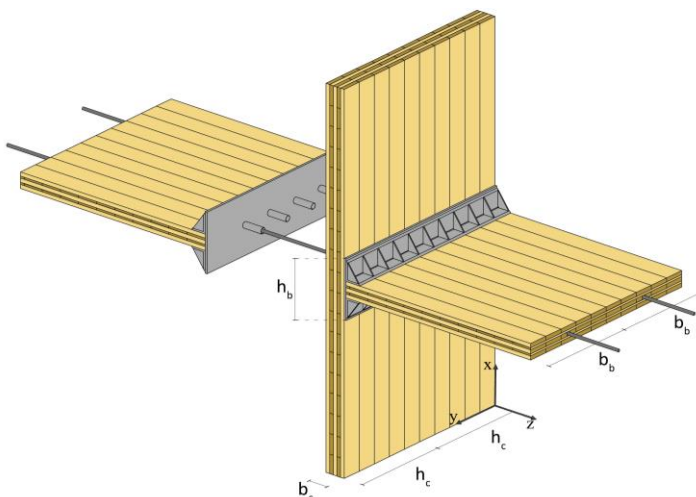

Table 183 – Comparison between the values used in [164] and the CLT vertical element made of birch; inputs used for the calculation of the rotational behaviour (half of the total depth)

	D40 [164]	CLT-Birch
$E_{90,mean}$ (MPa)	860	650
$G_{0,mean}$ (MPa)	810	-
S_{xz}/b_c (MPa)	-	246
$f_{c,90,k}$ (MPa)	8.3	5
b_c (mm)	280	200
h_c (mm)	600	1'000
b_b (mm)	400	1'000
h_b (mm)	600	600

Figure 221 – Axonometric view of the PT-connection between CLT panels by means of steel unbonded cables and steel composed plates; the parameters identified in Table 183 are visualised

The adaptation of the analytical model has been described in Section 5.3.3.3 for the implementation of the rotational behaviour of the PT-CLT connection in the seismic analyses of the main structure.

The transition from a beam-column system with linear elements to a system with two-dimensional elements involved the use of a composite steel plate to increase the contact surface between horizontal and vertical elements, maintaining an adequate rotational stiffness (as a function of the height of the horizontal element, considering the steel plate) without incurring a premature failure of the grain compressed perpendicularly (Figure 221).

The analytical model presented in the previous section, with reference to [164, 169], is then used for the determination of the rotational behaviour of the PT-CLT connection using the corresponding mechanical and geometrical properties and considering:

- the height of the horizontal element equal to the height of the steel plate fixed to the CLT walls (h_b) in Figure 221;
- the shear stiffness per meter of CLT divided by the walls thickness S_{xz}/b_c instead of the shear modulus (G_c).

Table 183 reports the comparison between the input considered for the application on glulam column-beam subassemblies and CLT panels, while Figure 222 reports the stress distribution at the connection interface for the different cases evaluated for the main design.

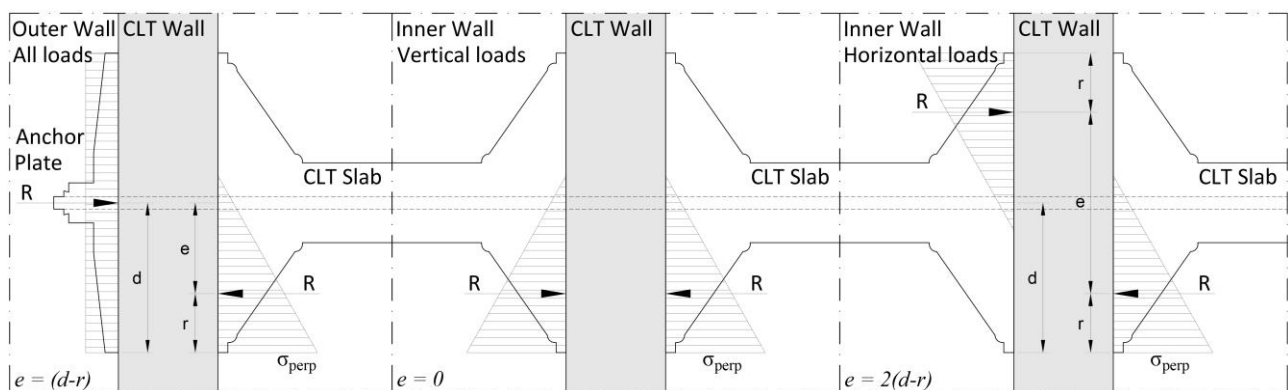

Figure 222 – Distribution of stresses at the connection interfaces of outer and inner walls in the cases of vertical and horizontal loads (VL, HL) for the adaptation to CLT panels

The adaptation of the analytical model to the system allowed the determination of the behavioural laws describing the moment, the compression perpendicular to the grain, the position of the neutral axis and the tendon force in relation to the rotation at the interface. Figure 184 in Section 5.3.3.3 shows these relationships with reference to the CLT strengthening system provided for the main project.

6.3 Connection tests

The experimental tests were carried out at the material testing laboratory (MPA-BAU) of the Technical University of Munich. Compared to the connection designed for the main strengthening system (Section 5.3.3.3), the validation tests were downsized in order to minimise the amount of material required, while maintaining the objective of testing the specimens on a 1:1 scale. Only a part of the connection was analysed by considering elements of the same thickness as those foreseen for the main structure, but reducing the width, the length, and the forces involved. The use of steel plates to enlarge the contact area between the horizontal and vertical elements was foreseen in order to demonstrate the possibility of adopting the above-mentioned analytical system, also for the CLT post tensioned panels. Therefore, in order to prove the effectiveness of the steel plates for the system and the accuracy of the analytical model to describe the rotational behaviour, different test configurations were investigated, varying the material used for the vertical elements (walls), with and without the provision of the composed steel plates (Figure 223).

The specimens are composed of three wooden elements (two representing the floors and one representing the walls), prestressed together by means of an unbonded steel threaded rod passing through

the elements. Due to budget limitations, safety constraints, and suppliers' availability, four configurations were tested (Figure 223).

- PTT2 – PT connection test between two horizontal CLT pieces (spruce, C24), connected to a vertical CLT element (spruce, C24) by means of a threaded steel PT rod.
- PTT3 – PT connection test between two horizontal CLT pieces (spruce, C24), connected to a vertical LVL element by means of a threaded steel PT rod.
- PTT4 – PT connection test between two horizontal CLT pieces (spruce, C24), connected to a vertical CLT element (spruce, C24) by means of a threaded steel PT rod and providing an intermediate steel plate to extend the contact interface.
- PTT5 – PT connection test between two horizontal CLT pieces (spruce, C24), connected to a vertical LVL element by means of a threaded steel PT rod and providing an intermediate steel plate to extend the contact interface.

The use of LVL elements as vertical walls was done to provide a more rigid variant to the use of CLT elements in spruce in vertical position. The values of $E_{c,90}$ and $f_{c,90,k}$ of the LVL specimens used for the experimental investigations, in fact, allowed to obtain results comparable to the use of birch CLT elements (solution provided for the main project solution). However, as also specified by the suppliers, the use of LVL elements for an application such as the one proposed for the main project would not be feasible due to higher costs and problems related to creep and swelling of a full-scale wall element.

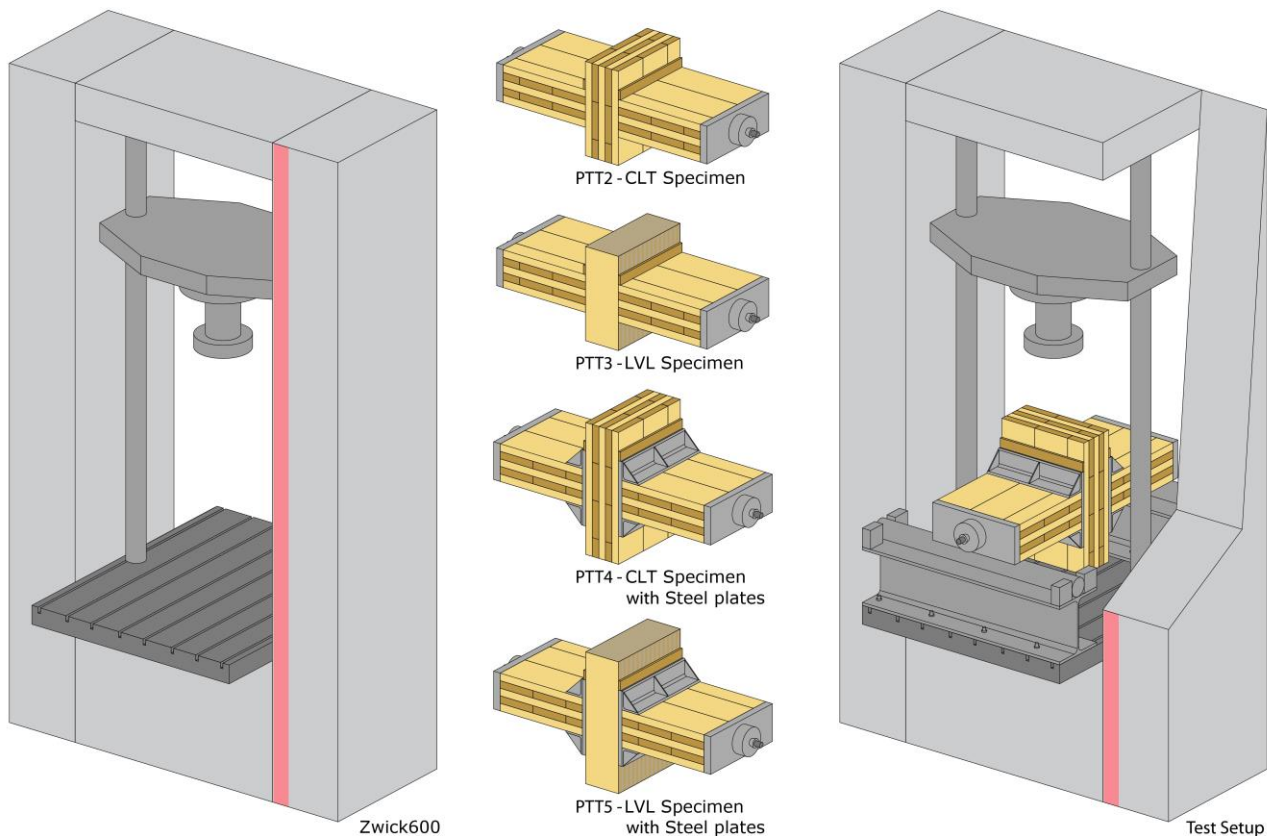

Figure 223 – Axonometric sketches of the Zwick600 hydraulic drive used for applying the vertical loads, of the different specimens provided and of the test setup

6.3.1 Mechanical and physical properties of the timber specimens

In order to better characterise the analytical model during the comparison with the test results, basic mechanical tests were carried out on the material used for the vertical element (wall). The mechanical tests

were conducted according to EN 408 [205], while moisture content and density were determined according to EN 13183-1 [206].

Five samples of CLT and six of LVL, both in spruce (C24) were tested to obtain the modulus of elasticity in compression perpendicular to the grain (CLT: $E_{c,90,mean}$ /LVL: $E_{c,90,edge,mean}$) and the compression strength perpendicular to the grain (CLT: $f_{c,90,mean}$ /LVL: $f_{c,90,edge,mean}$).

The samples were then cut, measured, and dried to determine the density and moisture content.

6.3.1.1 Material and dimensions

The materials tested were five-layer (40-40-40-40-40 mm) CLT specimens made in spruce (C24), manufactured by the Austrian brand *KLH* (and supplied with the support of *ABA Holz*), and a 19-layers LVL-R in spruce (C24) manufactured by the German brand *STEICO*. Table 184 shows the mechanical values given in the technical sheets as a basis for comparison with the tests results. The values were obtained from ETA-06/0138 [163] for CLT and from declaration of performance 03-0008-03 [207] for LVL pieces. Regarding the modulus of elasticity given for LVL, many manufacturers do not indicate the value investigated. Since it is used in an unusual configuration for these tests, the value specified in Table 184 for $E_{c,90,edge,mean}$ must be considered as not strictly referential.

Table 184 – Material properties for the CLT (ETA-06/0138) and the LVL-R (DOP 03-0008-03)

Description	Symbol [unit]	KLH CLT-Spruce	STEICO LVL-R-Spruce
Modulus of elasticity parallel to grain	$E_{c,0,mean}$ [MPa]	12'000	14'000
Modulus of elasticity perpendicular to grain	$E_{c,90,mean}$ [MPa]	370	-
Modulus of elasticity, edgewise perpendicular to grain	$E_{c,90,edge,mean}$ [MPa]	-	430
Compressive strength perpendicular to grain	$f_{c,90,k}$ [MPa]	2.7	-
Compressive strength, edgewise perpendicular to grain	$f_{c,90,edge,k}$ [MPa]	-	7.5
Density	ρ_{mean} [kg /m ³]	420	550

The dimensions of the test specimens were determined on the basis of EN 408 [205] and depending on the available material. While for the CLT elements it was possible to perfectly comply to the dimension requirements, the LVL-R specimens were kept with a width (b) of 75 mm instead of 100 mm, due to the size of the available raw material boards. Figure 224 shows the parts used for the compression tests.

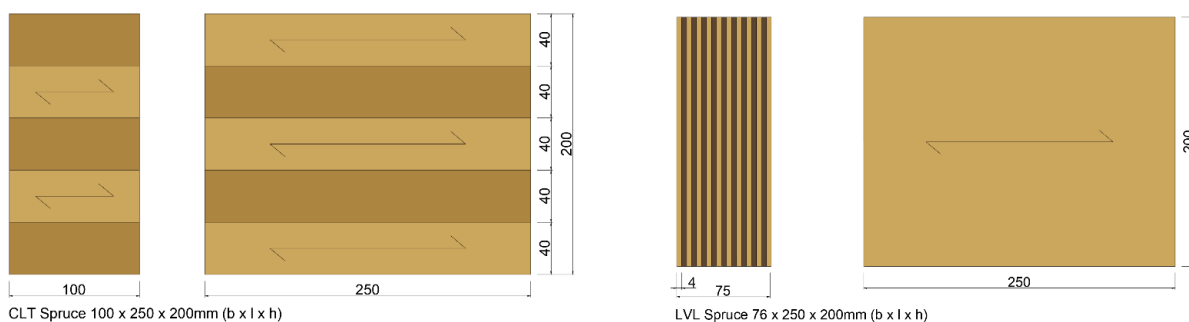

Figure 224 – Cut specimens of CLT and LVL-R for the compression tests – Source: [208]

6.3.1.2 Instrumentation and test setup

The hydraulic drive (Zwick600) was used to apply the compressive loads. This, along with the two transducers used to measure deformation and a load cell (force transducer) to accurately measure vertical force, was connected to the computer and monitored during each test. The Zwick600 was not precisely calibrated and required an additional measuring device to accurately record the vertical force used for the calculations. Section 6.3.2 contains all the instrumentation data.

Each specimen was loaded with a steadily increasing load (F_{max}) distributed on the top-surface by steel plates. The transducers were positioned to measure the displacement withing 2/3rds of the specimen height. Figures 225a 225b show the setups of the CLT and the LVL-R specimens, respectively.

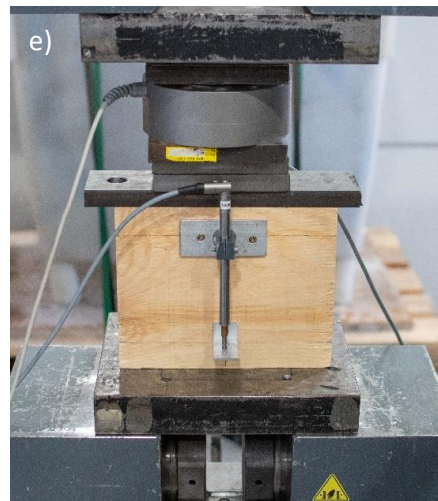
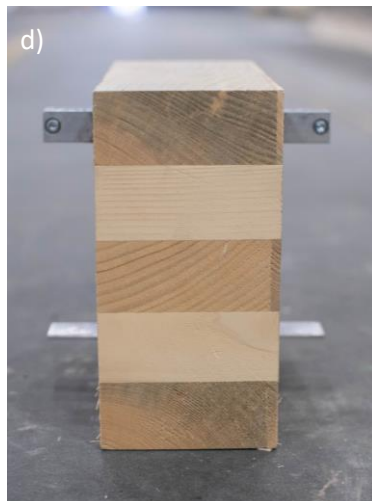
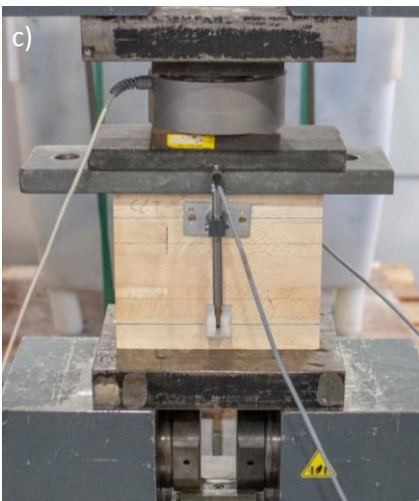
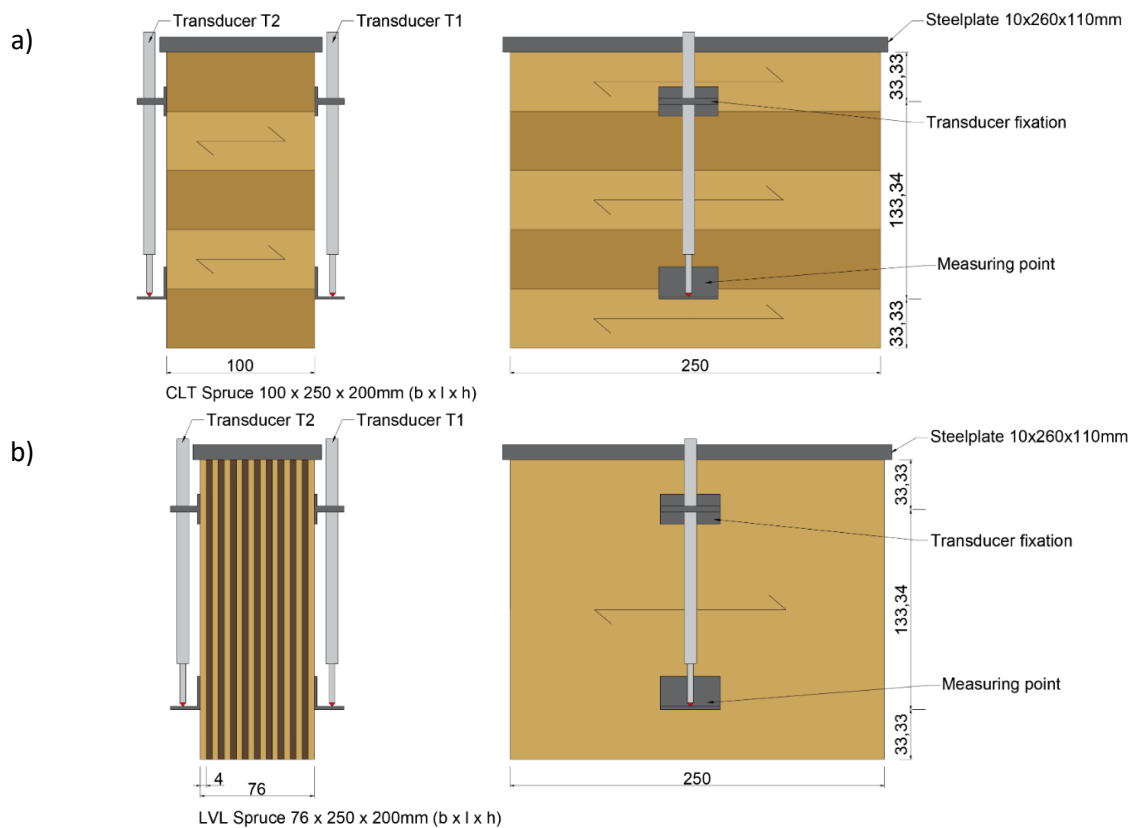

Figure 225 – Setup for the compression tests of CLT and LVL-R specimens; a) drawings of the CLT-setup; b) drawings of the LVL-R setup; c) and d) photos of the CLT setup; e) photo of the LVL-R setup – Source: [208]

6.3.1.3 Test procedure and data evaluation

The five CLT tests (CLT-1 to CLT-5) and six LVL tests (LVL-1 to LVL-6) were performed according to EN 408 [205]. During the tests, the force applied by the hydraulic drive increased and the compressive loads and vertical displacements were constantly recorded. The experiment was stopped as soon as the maximum load capacity of the specimen was reached, or the failure of the test specimen compromised the transducer measurement. Figure 226 shows an example of large deformation of a CLT specimen. The expansion and crushing of the grain involved displacement of the measuring supports.



Figure 226 – Highly deformed CLT-piece without transducers – Source: [208]

For each step, loads and displacements were recorded. As a consequence, two force-displacement curves resulted from each compression test.

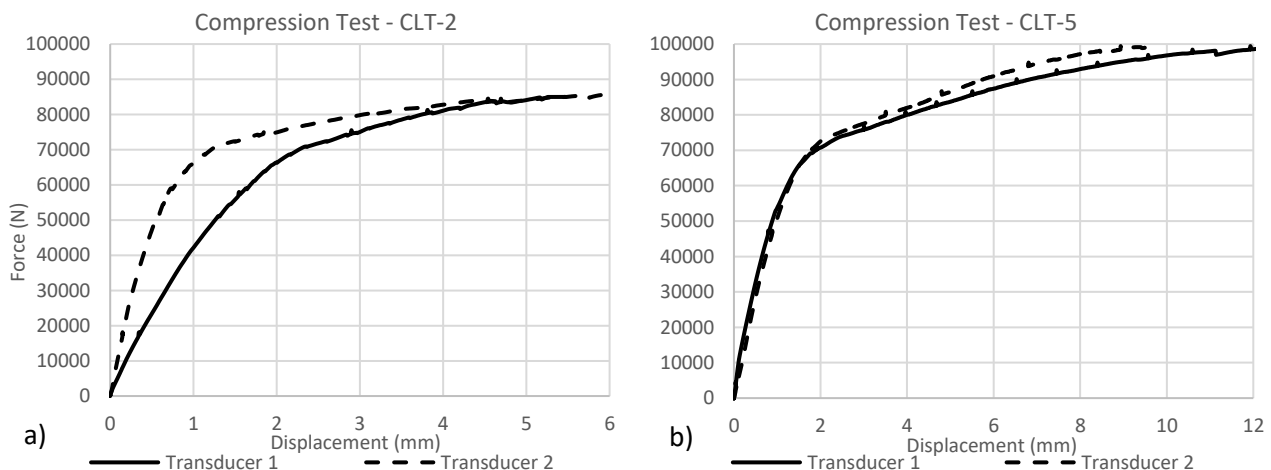

Figure 227 – a) Force-displacement curves presenting deviation from the two sides of the CLT-2 sample; b) force-displacement curves for the homogeneous CLT-5 sample

The presence of crossed layers in the CLT specimens hindered the possibility of reaching the maximum force. Having layers in both directions, the expansion of the layer in one direction was always counteracted by the bonding with the adjacent layers, having the grain in longitudinal direction. Therefore, a decline of the strength curve could not be found and the CLT specimens were compressed slowly, showing the grain crushing on different sides. The non-homogeneous grain distribution in the lamellae led to different deformations on the two measured sides, as shown in Figure 227a.

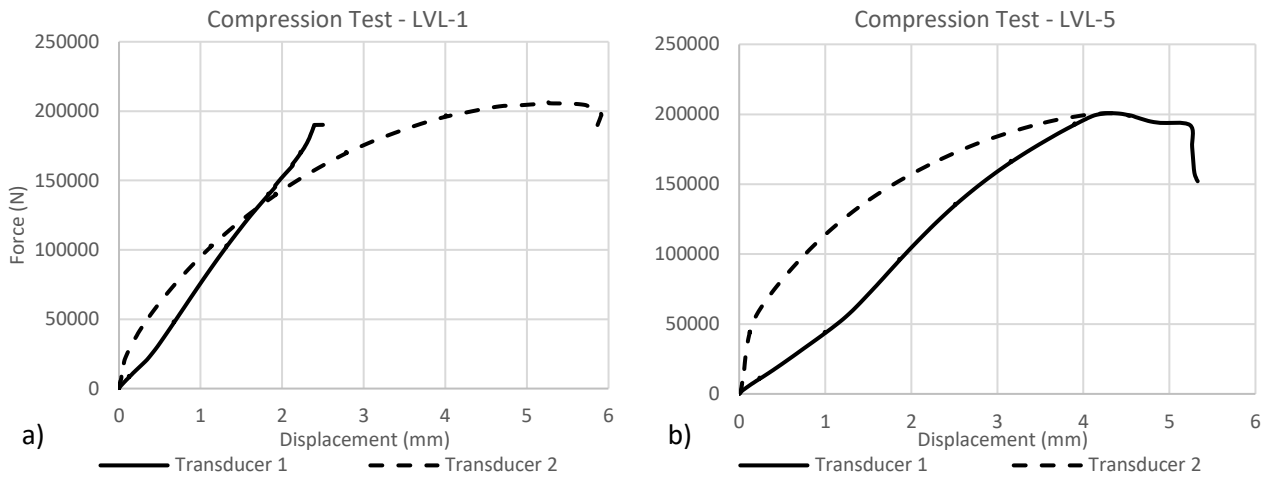

Figure 228 – a) Force-displacement curves presenting the compromising local failure on one side of the LVL-1 sample; b) force-displacement curves for the LVL-5 sample

For LVL, it can be noticed that the crushing of the grain occurred irregularly on one of the two sides and led to the lifting of the grain locally around the transducers support, often compromising the result on that side (Figure 228a). However, all test data (both sides) were considered to evaluate the strength and modulus of elasticity in compression perpendicular to the grain.

$E_{c,90}$ and $f_{c,90}$ were calculated for each curve obtained, following the guidelines presented in EN 408 [205], and using the equations (6.22) and (6.23).

$$f_{c,90} = \frac{F_{c,90,max}}{bl} \tag{6.22}$$

$$E_{c,90} = \frac{(F_{40}-F_{10})h_0}{(w_{40}-w_{10})bl} \tag{6.23}$$

with

- h_0 - measuring distance
- b - width of the specimen
- l - length of the specimen
- $w_{40} - w_{10}$ - increment of deformation corresponding to $F_{40} - F_{10}$ (mm)
- $F_{40} - F_{10}$ - increment of load on the straight-line part of the curve (10% and 40% of $F_{c,90,max}$)

$F_{c,90,max,est}$ was first estimated, then $0.1F_{c,90,max,est}$ and $0.4F_{c,90,max,est}$ were determined and a straight line was drawn, connecting these two points. Parallel to the first line, a second line (line 2) was drawn at a distance from it, equivalent to a deformation of $0.01h_0$, as shown in Figure 229. Where line 2 intersects the curve of the test results is $F_{c,90,max}$. The procedure was repeated until the difference within $F_{c,90,max,est}$ and $F_{c,90,max}$ was within 5%.

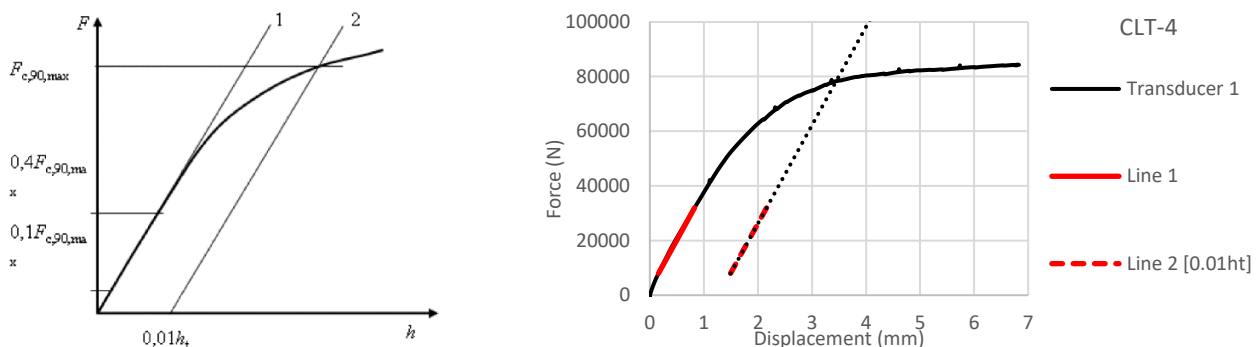

Figure 229 – Load-deformation graph from standard representing the procedure to determine $F_{c,90,max}$ and application to CLT-4 sample – Source: [205]

After each test, a slice of each sample was cut and measured in volume and weight to determine the density and moisture content according to EN 13183-1 [206]. The slices were measured, weighed, dried in the oven, and weighed again (Figure 230). The moisture content ω , as a mass percentage, is reported together with the result of the mechanical tests in Tables 185 and 186.



Figure 230 – Photo of all the tested specimen during the drying phase – Source: [208]

6.3.1.4 Results of the mechanical tests

For each sample examined, a mean value was calculated between the results of the two transducers (CLT-1 to CLT-5 and LVL-1 to LVL6). The mean values $E_{c,90,mean}$ and $f_{c,90,mean}$ were then calculated by considering all samples and reporting the relative standard deviation (SD).

Table 185 – Results of mechanical and physical tests for the CLT samples

	CLT-1	CLT-2	CLT-3	CLT-4	CLT-5	Mean value	SD
$f_{c,90}$ [MPa]	3.37	3.03	3.00	3.16	3.04	3.12	0.04
$E_{c,90}$ [MPa]	362.46	400.99	279.19	970.32	315.56	465.70	0.55
ρ [kg /m ³]	415.73	455.48	408.22	457.17	441.34	435.59	0.05
ω [%]	10.6	11.1	10.2	11.1	10.2	10.64	-

Due to the inhomogeneity of the material and the small amount of the tested specimens, a large deviation could be observed for the modulus of elasticity in compression perpendicular to the grain. More consistent results were found for LVL pieces (Table 186).

Table 186 – Results of mechanical and physical tests for the LVL samples

	LVL-1	LVL-2	LVL-3	LVL-4	LVL-5	LVL-6	Mean value	SD
$f_{c,90,edge}$ [MPa]	9.86	9.37	9.26	10.20	9.23	9.33	9.58	0.04
$E_{c,90,edge}$ [MPa]	625.62	637.93	561.61	623.76	930.36	656.23	675.86	0.18
ρ [kg /m ³]	637.21	653.05	650.78	638.84	661.37	641.49	647.12	0.01
ω [%]	8.8	9.6	9.5	9.1	9.5	8.6	9.18	-

The moisture content ω was measured within the expected ranges of $12\pm 2\%$ for the CLT samples and 9% for the LVL samples. The density ρ was slightly higher than the mean value specified by the manufacturer for the CLT samples and substantially higher for the LVL elements. The variability of the results in terms of

compression strength and elastic modulus, dependent on the intrinsic heterogeneity of the wood material, is visually shown in the graphs below (Figures 231 and 232).

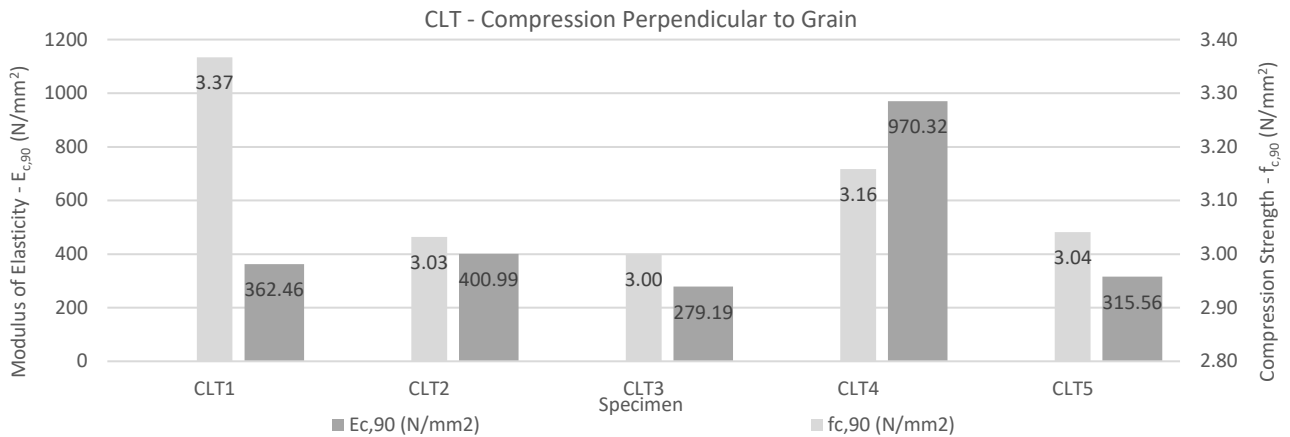

Figure 231 – Bar-graphs visualising the results of the compression test on the CLT specimens (C24)

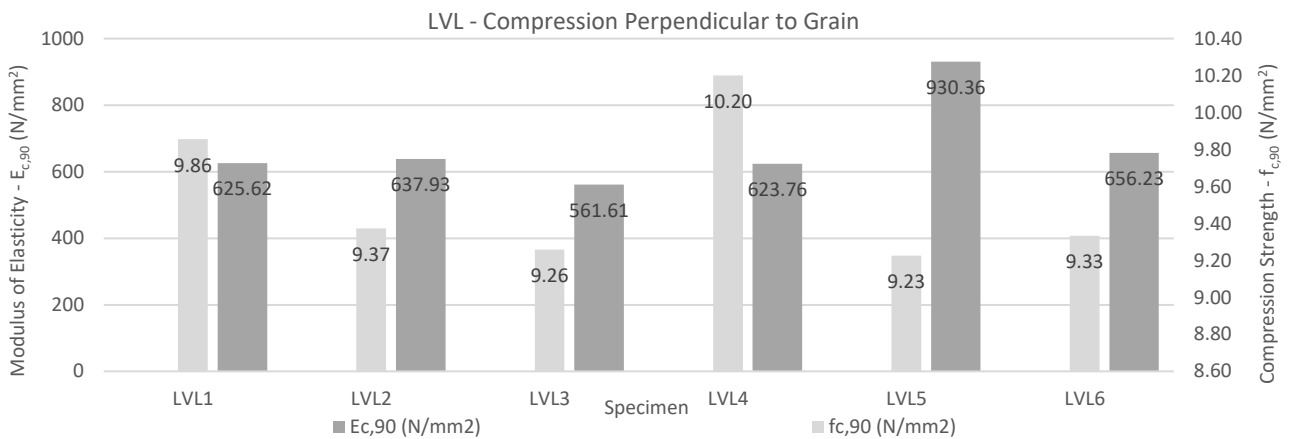

Figure 232 – Bar-graphs visualising the results of the compression test on the LVL-R specimens

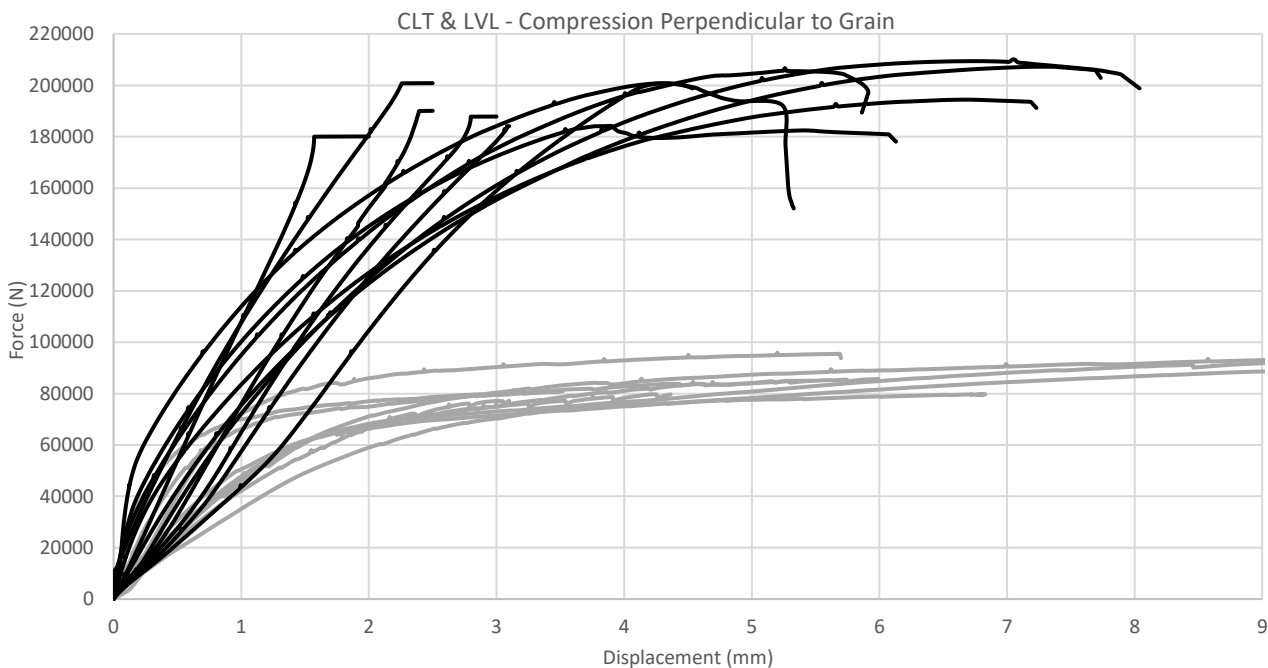

Figure 233 – Force-displacement curves of all the recorded values, considering both transducers for every sample; the black and grey curves represent the results from LVL and CLT specimens, respectively

The more tests are carried out, the better would be the mean value representing the material behaviour determined by the manufactures.

However, the results obtained were used in the main PT tests in order to verify the accuracy of the analytical model with the experimental results since they constitute a part of the same load of material.

Finally, Figure 233 is shown to picture the behaviour comparison between the two types of specimens and to highlight the small deviation of initial stiffness for low compressive forces with difference to the calculated values in Tables 185 and 186.

6.3.2 PT-CLT connection, specimens, instrumentation, and setup

6.3.2.1 Materials and specimens

The specimen consists of two horizontal CLT elements (representing the slabs) and one vertical element representing the wooden walls. The CLT slabs are made of five layers (5L) of spruce (40-40-40-40-40 mm). For the specimens with steel composed plates, 40 mm thick LVL layers of beech (“Baubuche” boards from Pollmeier) are provided as reinforcement (Figure236b). The vertical elements consist of 200 mm CLT-5L spruce panels (Figures 234b and 235a) or LVL-R panels made from 75 mm thick Steico LVL-R boards (Figures 234c and 235b). The strength and stiffness values of the materials are summarised in Table 187.

An unbonded threaded steel rod running through a hole, drilled longitudinally in the horizontal CLT elements (middle layer) and through the vertical element, is fixed at both ends of the specimen with washers and nuts (Table 188). The thick steel plates manufactured with S235 were supplied by the German company Hundegger.

Table 187 – Material properties for the CLT (ETA-06/0138) and the LVL-R (DOP 03-0008-03); the mean values from the mechanical tests are reported next to the data available from technical sheets (TS-Data)

Symbol [unit]	KLH CLT-Spruce		STEICO LVL-R-Spruce		POLLMEIR BauBuche Q
	TS-Data	Measured mean	TS-Data	Measured mean	TS-Data (th≤24)
$E_{c,0,mean}$ [MPa]	12'000	-	14'000	-	11'800
$E_{c,90,mean}$ [MPa]	370	465.7	-	-	3500
$E_{c,90,edge,mean}$ [MPa]	-	-	430	675.86	-
$f_{c,90,k}$ [MPa]	2.7	3.12	-	-	16
$f_{c,90,edge,k}$ [MPa]	-	-	7.5	9.18	40
ρ_{mean} [kg /m ³]	420	435.59	550	647.12	770

Table 188 – Properties of the threaded rod used as tendon for the PT-CLT connection tests

Description	Symbol [unit]	Steel threaded rod – M30
Steel grade	-	8.8
Nominal minimum tensile strength	f_y [MPa]	640
Ultimate tensile strength	f_u [MPa]	800
Modulus of elasticity	E_p [MPa]	210'000
Cross-section area	A_p [mm ²]	707
Nominal stress area	$A_{p,res}$ [mm ²]	561
Threaded rod length	L_p [mm]	1'300
Proof load	F_p [kN]	337
Minimum ultimate tensile load	$F_{m,min}$ [kN]	466

Table 189 reports the combination of components provided for each main test (from PTT2 to PTT5) and the reference figures describing their geometries, layering and characteristics.

Table 189 – Combinations of elements used in the performed tests

Test	Vertical element	Horizontal element	Anchor plates	Steel composed plates
PTT2	CLT Spruce Figure 234b	2 CLT Spruce Figure 234a	2 Anchor plates Figure 236a	-
PTT3	LVL-R Spruce Figure 234c	2 CLT Spruce Figure 234a	2 Anchor plates Figure 236a	-
PTT4	CLT Spruce Figure 235a	2 CLT Spruce Figure 236b	2 Anchor plates Figure 236a	2 Composed plates Figure 237
PTT5	LVL-R Spruce Figure 235b	2 CLT Spruce Figure 236b	2 Anchor plates Figure 236a	2 Composed plates Figure 237

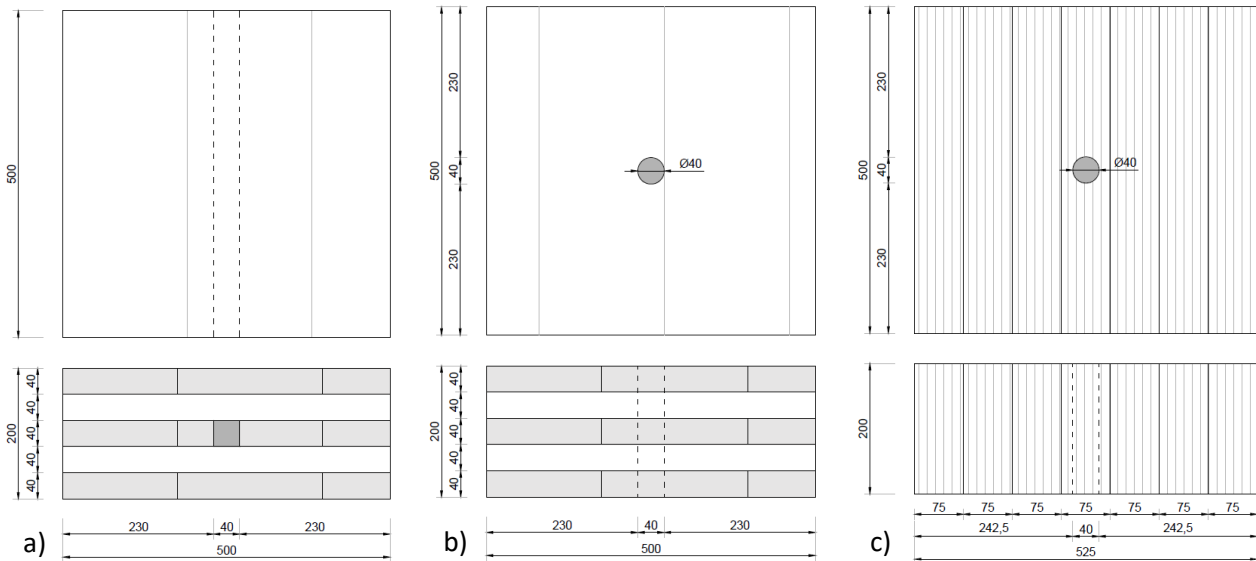

Figure 234 – a) CLT horizontal element; b) CLT vertical element; c) LVL-R vertical element

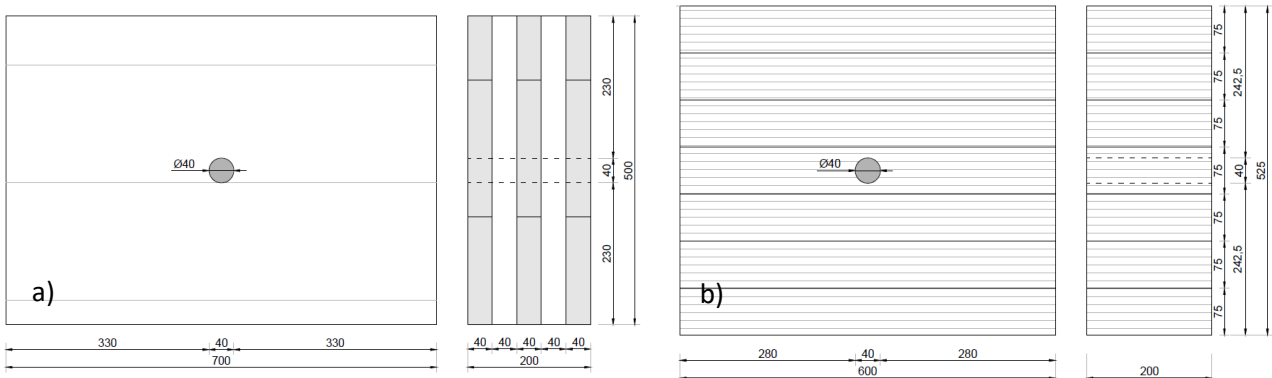

Figure 235 – a) CLT vertical element for the PTT4; b) LVL-R vertical element for the PTT5

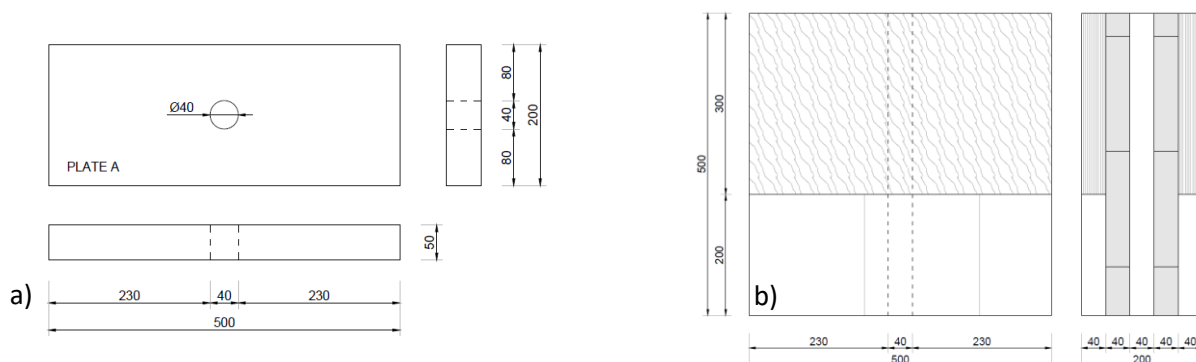

Figure 236 – a) Steel anchor plate; b) CLT horizontal element reinforced with LVL made of beech

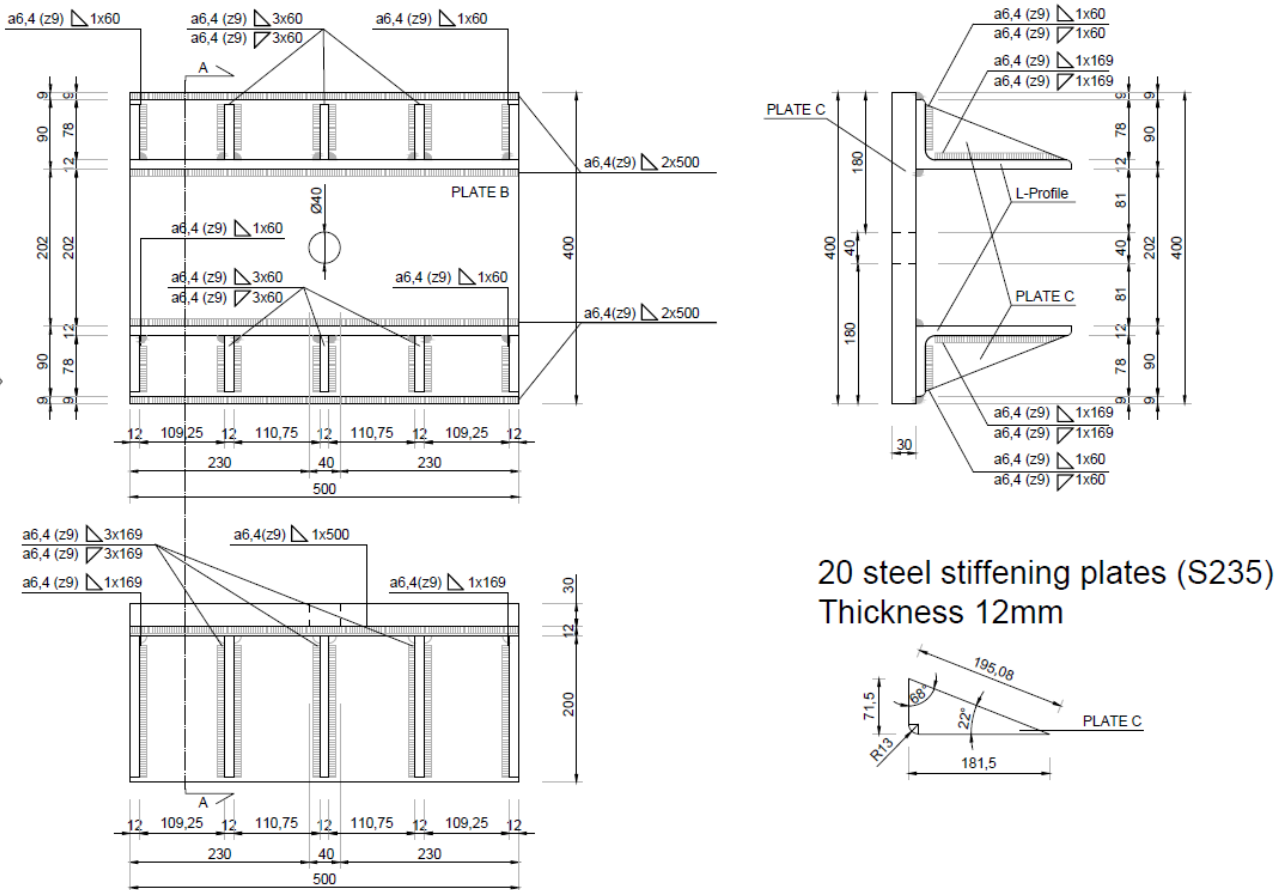

Figure 237 – Steel composed plate for enlarging the interface of the PT connection

Figure 236a shows the steel plate used to anchor the tendon at the end of the beam and to transfer the loads from the tendon to the horizontal members, while Figure 237 shows the composed steel plate, designed to widen the contact interface between horizontal and vertical members and to rigidly transfer the rotation at the interface. The plates were oversized in order to repeatedly use the same components for all tests without any residual deformations.

6.3.2.2 Setup

The tests only investigated the behaviour under vertical loads of the PT connection and the whole setup was designed to minimise the size of the specimens in order to fit the hydraulic drive worktable (Zwick600). Instead of pushing down the horizontal elements [164, 169], the setup provides two supports at the ends of the horizontal elements and the vertical element suspended through the prestressing of the tendon (Figures 238 and 239). The behaviour of the connection is then measured at the two interfaces of the vertical element while the hydraulic drive pushes it downwards.

Therefore, the setup was built on the Zwick600 and consists of two metal supports, bolted to the working table, which allow the specimen to be raised to a level that allows the vertical element to be moved downwards. Two hinges (cylindrical steel element with welded plate) were provided under the CLT horizontal elements to allow the rotation during the tests.

In order to prestress the specimen, temporary supports were provided for all the elements until the force was applied to the threaded rod. The tensioning process was repeatedly done manually with a hand pump connected to a hydraulic cylinder on the left side of the specimen (Figure 241). The setup drawings for PTT2 and PTT4 are shown in Figures 238 and 239. The scaled technical drawings are also shown in the Appendix of the manuscript. Figures 240 and 241, on the other hand, show photos of the setup for all the four main tests performed.

PTT2 - CLT Spruce

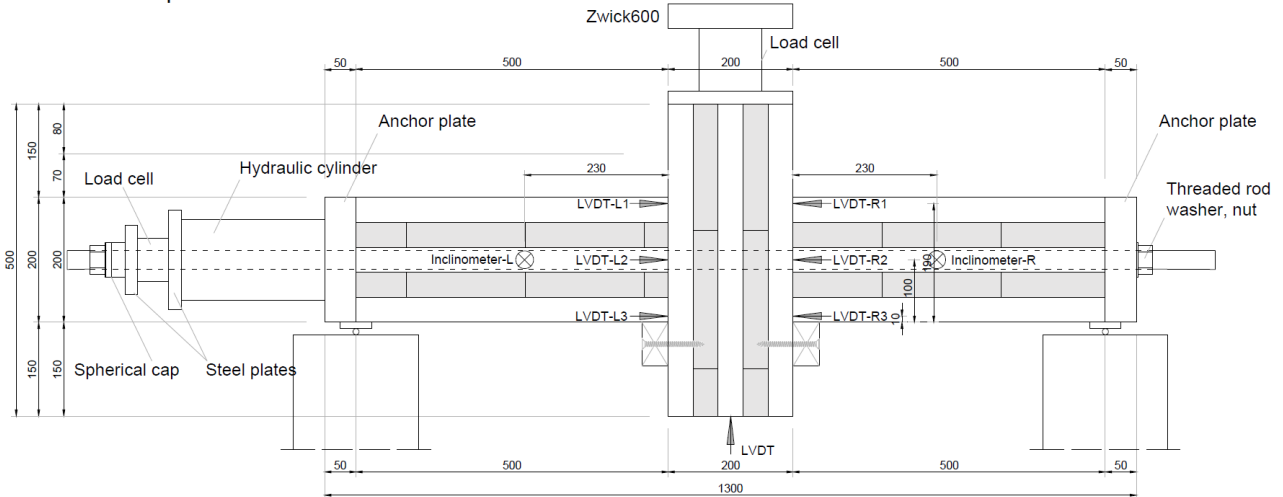

Figure 238 – Test setup for the specimen with the CLT vertical element (PTT2); the instrumentation consisting of linear variable differential transducers (LVDTs), inclinometers and load cells are indicated with reference to left and right slabs

PTT4 - CLT Spruce with steel plates

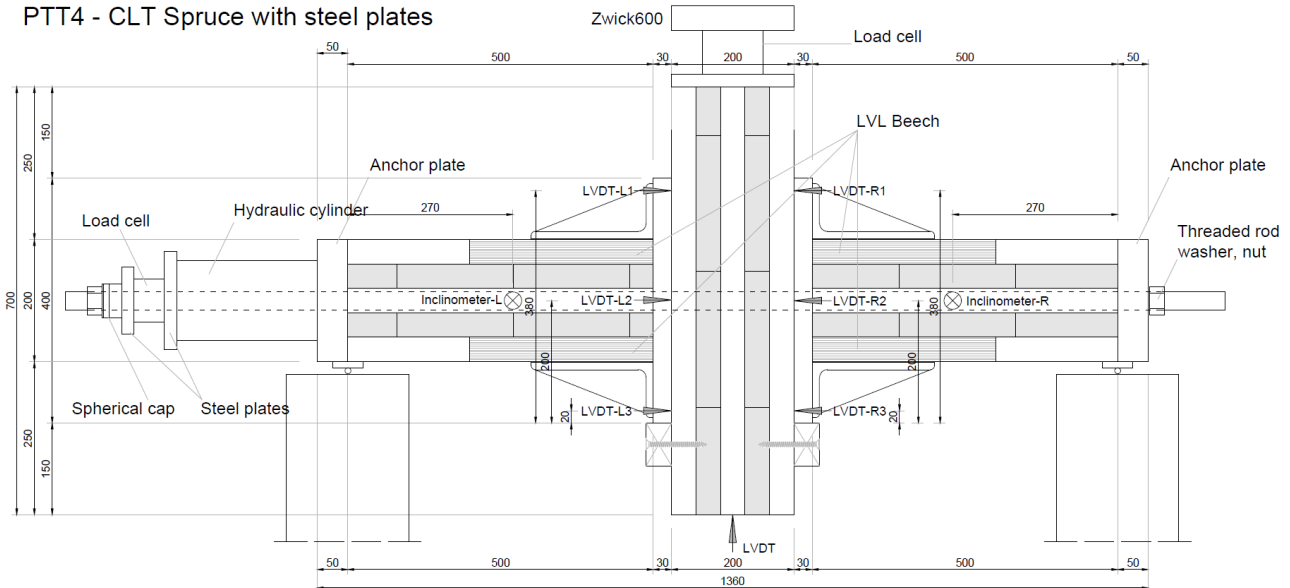

Figure 239 – Test setup for the specimen with the CLT wall and the steel plates (PTT4); the instrumentation consisting of LVDTs, inclinometers and load cells are indicated with reference to left and right slabs

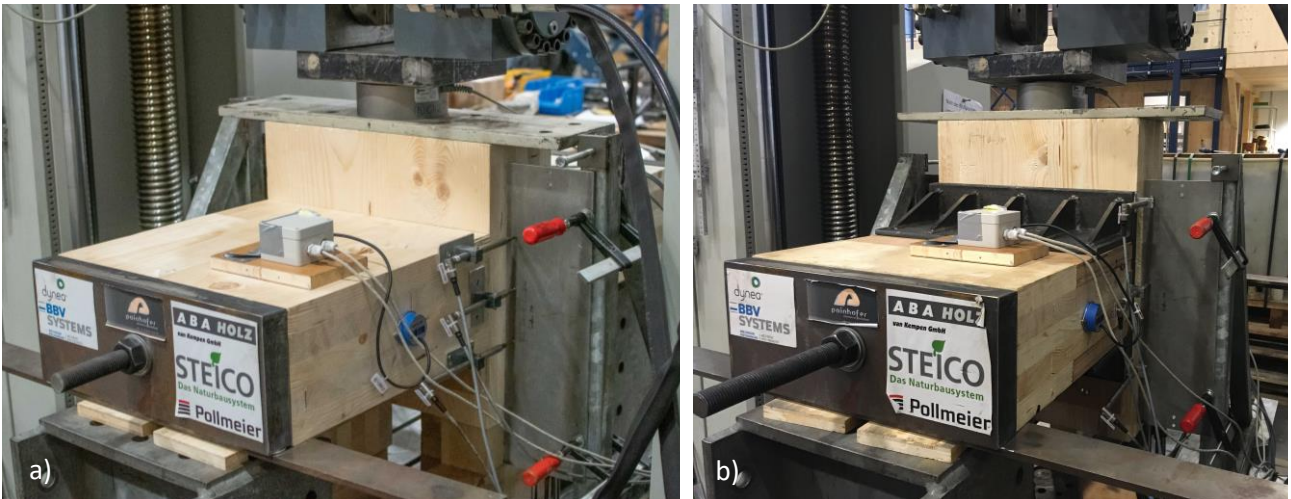

Figure 240 – a) Photo of the right side of the PTT2; b) photo of the right side of the PTT4

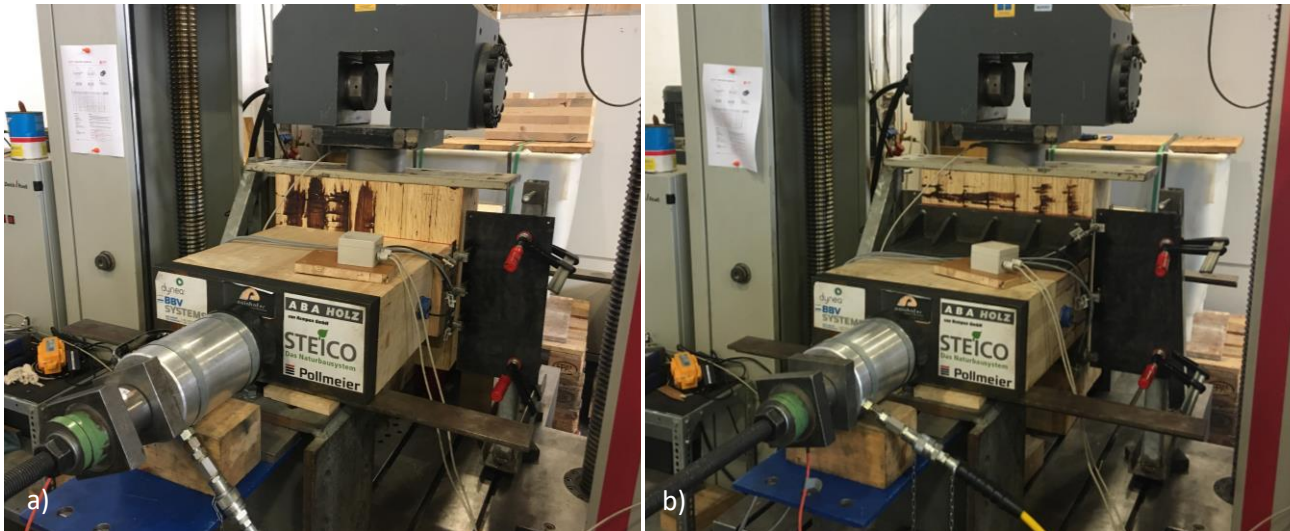

Figure 241 – a) Photo of the left side of the PTT3; b) photo of the left side of the PTT5

6.3.2.3 Instrumentation

In order to determine the behaviour of the PT-CLT connection, various measuring devices were kept with reference to the tests carried out by F. Wanninger [169, 209].

Table 190 – Measuring equipment with relative range of application

N°	Instrument	Range
5	LVDT – WA20	0...20 ± 0.01 mm
2	LVDT – WA50	0...50 ± 0.01 mm
2	Inclinometers – NG2	± 4 degrees ± 0.004
2	1-C6B Load cells (force transducers)	500 kN
1	Hydraulic drive Zwick600 (Roell)	600 kN

Linear variable differential transducers (LVDTs)

The linear variable differential transducers measured the displacement at the interface between the horizontal and vertical elements. Using the measurements obtained from the transducers, the initial compression in the vertical element was calculated, as well as the rotation at the connection interface. Six transducers were attached to the sides of the two horizontal elements in an alternating position in order to have results for both the left and the right samples. They were distributed along the height of the horizontal elements as shown in Figure 238 for the PTT2 and PTT3 and in Figure 239 for PTT4 and PTT5. In particular, for PTT2 and PTT3, starting from the lower edge of the CLT horizontal element, the transducers were positioned at 10 mm, 100 mm and 190 mm (Figure 242a). Similarly, starting from the lower edge of the steel composed plate for PTT4 and PTT5, the transducers were positioned at 20 mm, 200 mm, and 380 mm (Figure 242b). Finally, a transducer was placed under the vertical element to record the total vertical displacement of the specimen during the test cycles. All the transducers were pointed to steel plates attached to rigid frames mounted on the working table of the Zwick600.

Inclinometers

Inclinometers were used as an additional measurement instrument to record the rotation at the connection interface. Two devices were mounted at the side of the horizontal CLT elements at a distance of 230 mm from the edge of the CLT panel towards the connection interface (Figure 242c). The same position was foreseen for the specimen with the steel composed profile. The rotation at the connection interface was

calculated from the output of the inclinometers and adjusted, considering the influence of the elastic deformation of the CLT panel. By having two types of measuring systems to record the rotation, it was possible to compare and control the calculated rotation and thus have more reliable results.

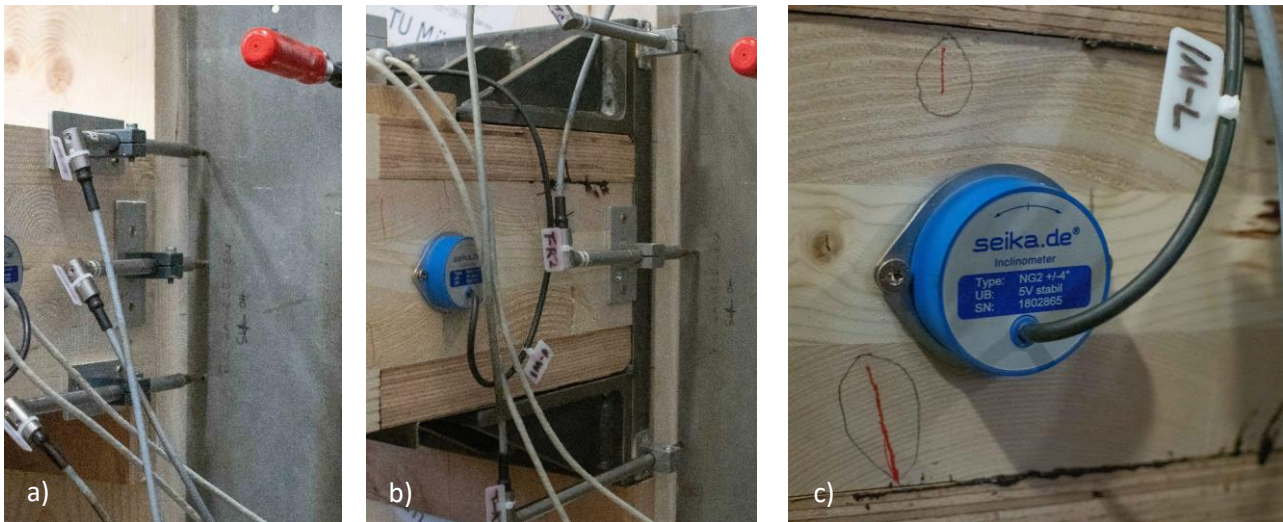

Figure 242 – a) Positioning of the transducers at the interface of PTT2; b) positioning of the transducers at the enlarged interface of PTT4; c) photo of the inclinometer fixed on the side of a reinforced CLT horizontal element

Load cells and hydraulic pump

Two load cells were positioned to measure and monitor the post-tensioning force and the compression force of the Zwick600. As the post-tensioning forces increase during the test, it was essential to constantly monitor the force in the threaded rod in order to be able to intervene in case of emergencies, such as the steel threaded rod reaching critical tensile values or sudden failures of other components. Figures 238 and 239 show the positioning of the load cells. Figure 243a shows the load cell positioned between the specimen and the steel plate of the Zwick600, due to the inaccuracy of the measuring device inside the main machine.

The hydraulic hand pump (Figure 243b) was used to apply and adjust the tension force in the threaded rod. Through the combined use of the load cell and the hand pump, it was possible to reload the pre-stressing force between the load cycles, also allowing a sudden removal of pressure in the tendon in case of danger. The pressure cylinder was fixed on the left side of the specimen directly behind the load cell.

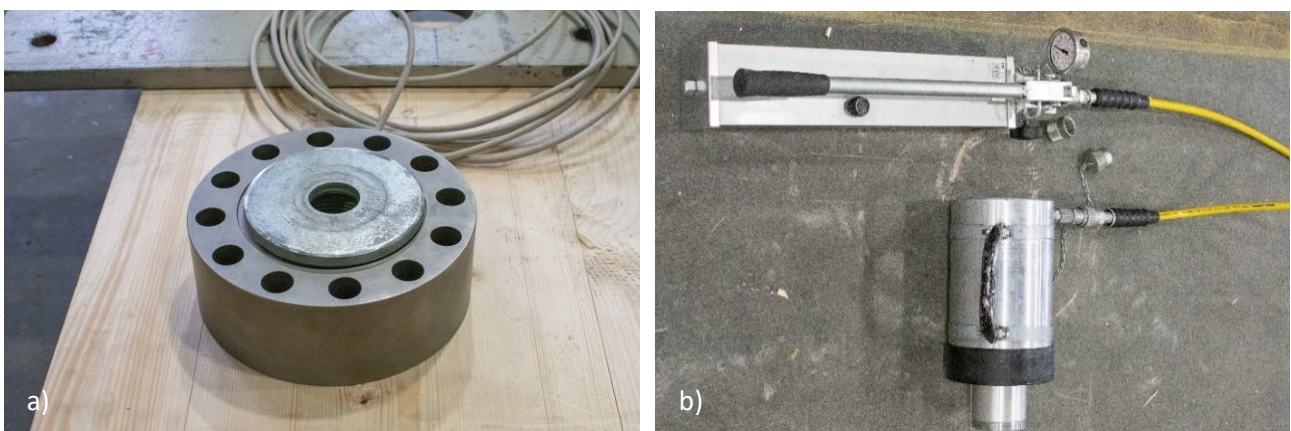

Figure 243 – a) Load cell positioned between the Zwick600 and the vertical element of the specimens; b) hand-pump and hydraulic cylinder provided for the application of the tension to the threaded rod

6.3.2.4 Test boundaries and issues

As mentioned in the previous paragraphs, the tests were designed and carried out with the aim of minimising costs, as a consequence of the fact that they were not initially foreseen in the research programme. The presented setup is the result of this containment process. The main limitations, together with the main problems encountered during the evaluation of the results, are listed here.

- The setup allowed to test the connection only under vertical loads. Therefore, it was not possible to apply asymmetrical loads which would have made it possible to check the deformation due to shear.
- Some tests initially planned were not carried out in order to limit the use of laboratory machines. PTT1 is an example; it was providing the test on the ideal connection in which the vertical element was considered infinitely rigid (steel plate). In addition, further mechanical tests to characterise the materials used were initially planned, but were not performed.
- The steel tendon was planned as a steel strand and anchored at the ends with special anchors (wedges and wedge casings). The material, which was available and supplied by BBV systems, had to be abandoned for reasons of laboratory safety before the beginning of the tests. The influence of the tendon on the connection system, as explained below, is significant.
- A major problem during the tests was the relative displacement of the specimen. During both the prestress and push-down phases, the hinged supports allowed the element to be displaced horizontally, partially compromising the results obtained from the transducers that were attached to the horizontal elements and pointed against rigid plates attached to frames mounted on the Zwick600 worktable. These relative displacements were recorded in the transducers compromising parts of their output data.
- The load cell of the Zwick600 was not calibrated correctly, presenting a force deviation of around 6%. Due to time constraints, the tests had to be carried out anyway and in a short time, which implied the use of the hydraulic drive with the deviation. Through the use of an additional load cell between the test specimen and the steel plate of the press, it was possible to take the correct value of the force while limiting the consequences to the determination of the protocols. These were defined by cycles entered in the machine and applied according to the force recorded by the Zwick600 load cell, always implying a discrepancy between the value imputed to the machine and actual value registered by the external load cell.

6.3.3 Testing program and protocols

Four types of tests were performed, varying the vertical element (CLT or LVL-R), the presence or absence of the steel widening plates, and the tension force provided by the steel threaded rod. For each type of test, at least three different samples of a similar vertical element were tested. The wall specimens loaded in combination with the steel composed plates (PTT4 and PTT5) were also tested repeatedly with all cycles, due to the absence of relevant failure in the perpendicularly compressed grain. A total of 29 tests were therefore realised in the testing hall of the TUM. An overview of all tests performed (excluding the test carried out to calibrate the measuring equipment) is given in Table 191, including the tendon force applied, the number of vertical load cycles and the maximum force applied, showing the deviation between the values imputed in the Zwick600 and the actual load, recorded by the external load cell.

Table 191 – Overview of the performed tests on the PT-CLT connection

Test type sample	Identification	Tendon force (kN)	N° cycles	Maximum load from Zwick600 (kN)	Effective maximum load (kN)
PTT2	PTT2-1	150	5	55	59.53
	PTT2-2	150	5	55	58.91
	PTT2-3	150	5	55	59.71

PTT3	PTT3-1	220	4	80	85.20
	PTT3-1	220	4	80	84.16
	PTT3-1	220	5	100	92.91 (manual stop)
PTT4-1	PTT4-1-1	220	5	150	161.55
	PTT4-1-2	220	5	150	161.88
	PTT4-1-3	220	5	150	160.96
	PTT4-1-4	220	5	150	160.97
PTT4-2	PTT4-2-1	220	5	150	160.71
	PTT4-2-2	220	5	150	160.38
	PTT4-2-3	220	5	150	160.01
	PTT4-2-4	220	5	150	160.15
PTT4-3	PTT4-3-1	220	5	150	160.31
	PTT4-3-2	220	5	150	159.87
	PTT4-3-3	220	5	150	157.06
PTT4-4	PTT4-4-1	220	5	150	160.99
	PTT4-4-2	220	5	150	159.38
	PTT4-4-3	220	5	150	160.71
PTT5-1	PTT5-1-1	300	6	200	213.90
	PTT5-1-2	300	6	200	212.27
	PTT5-1-3	300	6	200	212.36
PTT5-2	PTT5-2-1	300	6	200	210.43
	PTT5-2-2	300	6	200	210.41
	PTT5-2-3	300	6	200	210.04
PTT5-3	PTT5-3-1	300	6	200	211.99
	PTT5-3-2	300	6	200	211.44
	PTT5-3-3	300	7	250	258.66

All the components required to perform the test were prepared on the Zwick600 working table on temporary supports to maintain them in place. The test procedure then consisted of the following steps.

1. Preparation of the specimen parts on temporary supports.
2. Insertion of the threaded steel rod in the cavity. With the use of some small temporary supports, the rod was adjusted to the centre of the hole.
3. Insertion of the cylinder connected to the manual hydraulic pump and the load cell to constantly monitor the applied prestressing forces.
4. Start-up of the computer and measuring equipment. The specimen was still temporarily supported and the tendon force in the threaded rod was increased to 5-10 kN.
5. Application of the tendon force up to 100 kN to stabilise the specimen and remove the temporary supports.
6. Application of the prestressing loads expected, depending on the specimen type (PTT2: 150 kN; PTT3: 220 kN; PTT4: 220 kN; PTT5: 300 kN).
7. The press of the Zwick600 was driven on the upper surface of the vertical element.
8. The test is performed by pushing the vertical element down with the Zwick600 hydraulic drive following the load cycles indicated in the load protocol and recording the data.
9. Drive back upwards of the Zwick600 press.
10. Reduction of the tendon force to 100 kN to position the supports under the specimens.
11. Reduction and removal of forces in the tendon.

The loads are applied symmetrically on both sides of the test specimen as a reaction to the vertical displacement imposed by the hydraulic drive. While Table 192 shows the protocols defined for the first test of all types, Figure 244 shows their load-time diagrams with reference to the external load cell.

Table 192 – Loading protocols for the first test carried out for each type of specimen; the loads refer to the values imputed in the Zwick600 and have usually been deviated (increased) by about 6%, as also reported in Table 191 with reference to the load of the last cycles

Cycle	Type	Loads (kN)			
		PTT2-1	PTT3-1	PTT4-1-1	PTT5-1-1
0	Prestressing	150	220	220	300
1	Loading	15	30	40	70
	Unloading	0	0	0	0
2	Loading	20	50	70	100
	Unloading	0	0	0	0
3	Loading	25	70	100	130
	Unloading	0	0	0	0
4	Loading	40	80	130	150
	Unloading	0	0	0	0
5	Loading	55	-	150	180
	Unloading	0	-	0	0
6	Loading	-	-	-	200
	Unloading	-	-	-	0

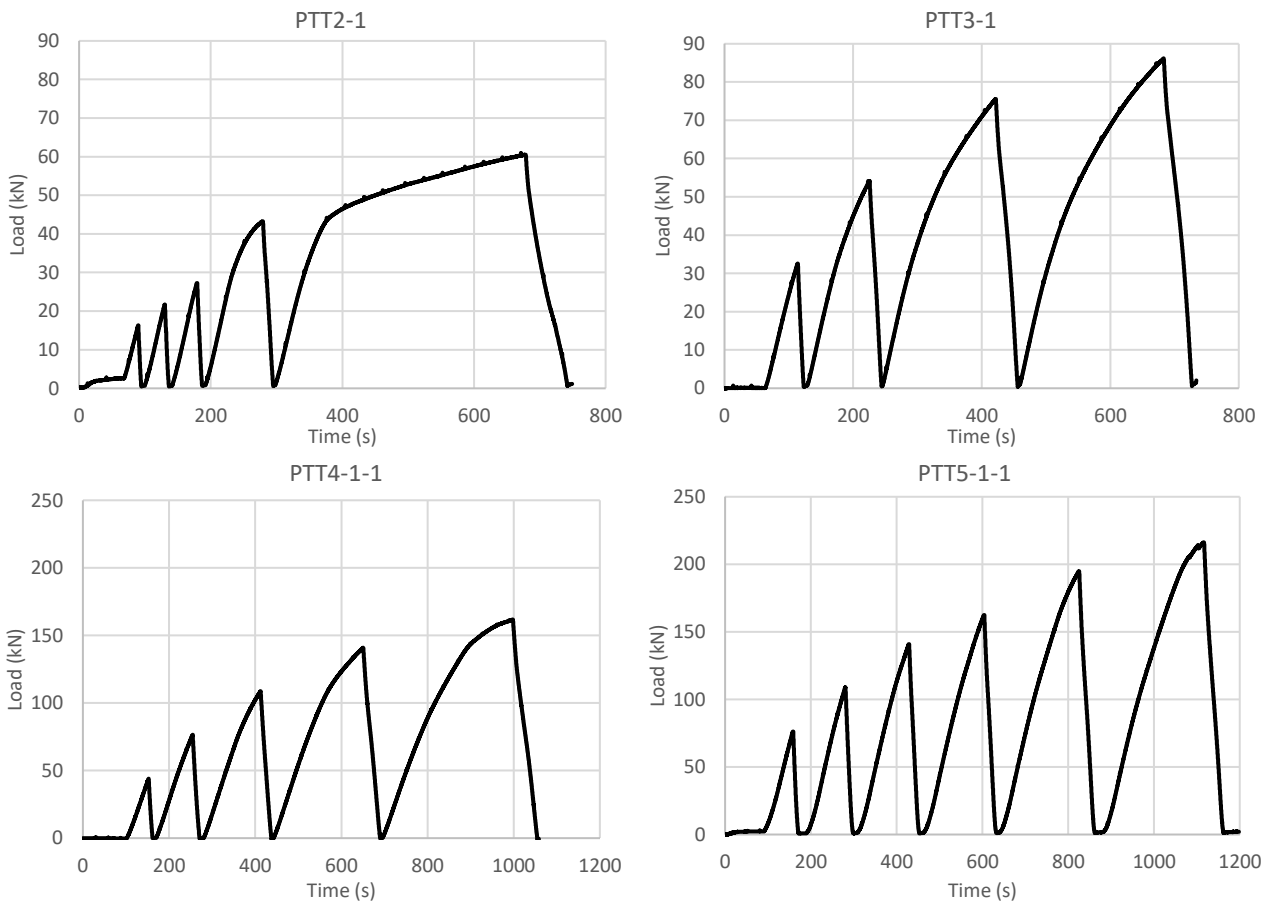

Figure 244 – Load-time diagrams for the first test carried out for each type of specimen; the loads refer to the effective values imputed by the external load cell installed between the vertical element and the Zwick600 press

After the description of the analytical evaluation of the experiments (Section 6.3.4), the presentation of the results is given for one case for each specimen type. A complete report on all the test results would in fact be too extensive. As illustrated in Section 6.4.1, a comparison between the tests performed on different samples resulted substantially consistent across all specimens of the same typology.

6.3.4 Analysis of the experiments

During the application of the tendon force, the horizontal elements were compressed against the vertical ones. This resulted in an initial compression value that was recorded at the connection interface through the displacement of the LVDTs. As soon as the vertical load was applied to the central element, a rotation, measured through the outputs of the LVDTs and inclinometers, began at the interface. This rotation led to the opening of a gap in the lower edge of the connection (the central element is pushed downward) and the subsequent concentration of stresses in the upper edges of the connection. This behaviour was recorded and described for the cases with and without the steel plates, with the formulation exposed in this section.

6.3.4.1 Application of the tendon force and initial compression

Before applying the vertical loads with the Zwick600, pre-compression is applied manually with the hydraulic pump (Figure 245a) and the resulting displacements are recorded on the two opposite surfaces of the two sides (Figures 245a and 245b) with the LVDTs. As mentioned in Section 6.3.2.4, unexpected relative displacements of the whole specimen were recorded during this phase and the application of the vertical load, which had to be taken into account for the calculation of the average deformation due to the initial compression.

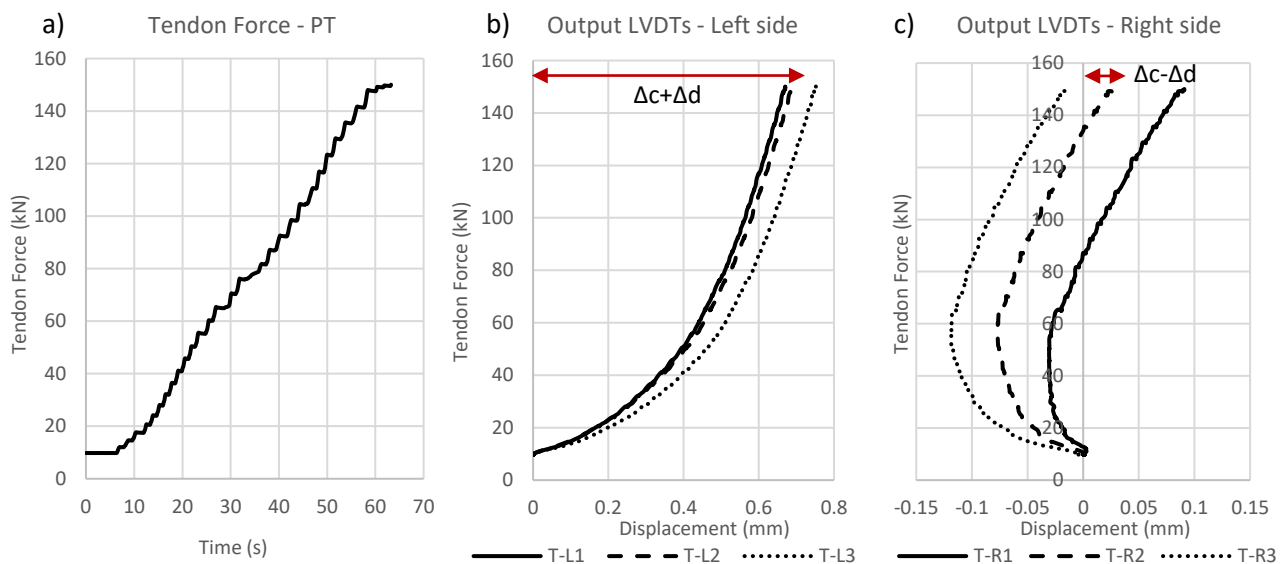

Figure 245 – a) Application of tendon force over time for PTT2-1; b) output of the transducers (displacement) on the left side of the vertical element for PTT2-1; T-L1, T-L2 and T-L3 represent the three transducers placed from top to bottom respectively; c) output of the transducers on the right side of the vertical element for PTT2-1; T-R1, T-R2 and T-R3 represent the LVDTs placed from top to bottom respectively

As shown in Figure 245, it is evident the problem occurred, as the transducers on the right side (Figure 245c) recorded displacements in two directions during the prestressing phase. A rigid sliding of the specimen, simple supported on the two sides, occurred during the procedure. In order to evaluate the actual initial compression on the vertical element, the contribution of the rigid displacement was calculated and subtracted from the final average values obtained for the two sides (left and right).

$$\begin{cases} \Delta c + \Delta d = T_{LM} \\ \Delta c - \Delta d = T_{RM} \end{cases} ; \quad w_{mean} = \frac{\Delta c}{2} \quad (6.24)$$

with

- Δc - effective compression investigated

- Δd - rigid displacement of the specimen during the prestressing phase
- T_{LM} - average value of the measurements taken by the transducers from the left side
- T_{RM} - average value of the measurements taken by the transducers from the right side

With (6.24) the initial compression in the vertical elements (Δc) was evaluated and divided by the two surfaces encountering deformation due to the tensioning. In the same way, the value is calculated for all the specimen types, paying attention to the direction in which the whole specimen was moving, and the influence of the steel widening plates for PTT4 and PTT5.

6.3.4.2 Rotation

To determine the curves describing the behaviour of the PT connection, the rotation at the interface was estimated with the output data. Three different methods to calculate the rotation were used to compare and corroborate the results and to increase the traceability of the behaviour.

Rotation calculated with transducers

The rotation is calculated using the displacements recorded by the transducers y_{T2} and y_{T3} on the respective side (Figure 246). The surface of the horizontal element is, in fact, assumed to remain plain during the rotation on the softer vertical element [169]. Therefore, the rotation can be calculated as indicated by (6.25) for the right (R) and the left (L) side.

$$\theta_{Tr} = \frac{y_{T3} - y_{T2}}{d} \quad (6.25)$$

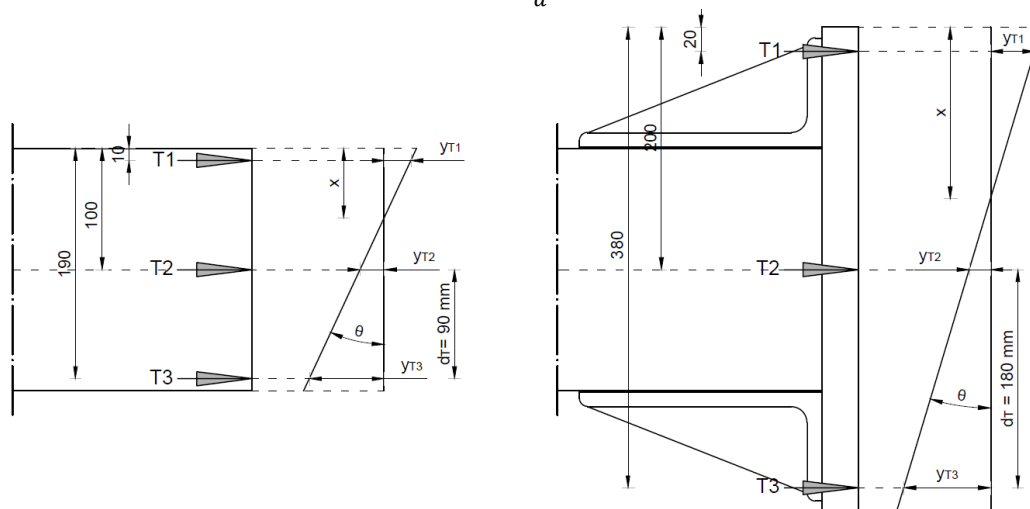

Figure 246 – Scheme representing the positioning of the transducers and the key variables for the determination of rotation (ϑ) and neutral axis (x) (mm as units)

Rotation calculated with inclinometers

The second way to calculate the rotation was to use inclinometers placed on the side of the horizontal element as described in the previous sections. The inclinometers directly gave a value for the rotation (θ_{tot}). However, they also measured the elastic deformation of the horizontal element (θ_{el}), which was then removed from the total value (6.26) to obtain the rotation at the interface (θ_{IM}).

The elastic rotation was calculated by considering the static scheme shown in Figure 247 and deriving the elastic line equation calculated for a value of x equal to 270 mm (indicating the position of the inclinometer) (6.26) and (6.27).

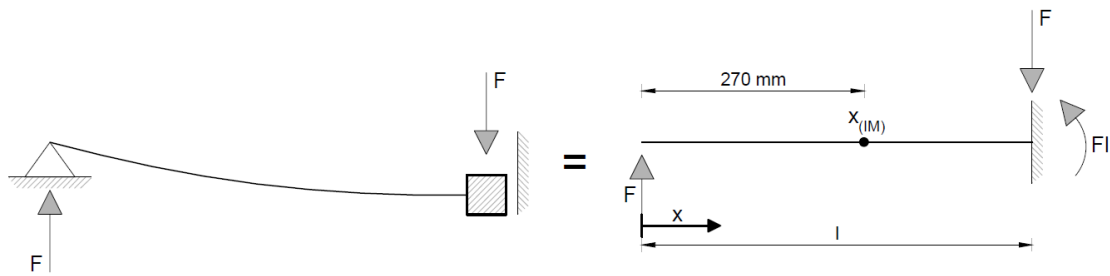

Figure 247 – Static schemes considered for the calculation of the elastic rotation (θ_{el}) to be removed from the input of the inclinometers

$$y(x) = \frac{F}{6EJ} (x^3 - 3l^2x + 2l^3) \tag{6.26}$$

$$\theta(x) = \frac{dy}{dx} = \frac{F}{2EJ} (x^2 - l^2) \tag{6.27}$$

$$\theta_{(x=270)} = \theta_{el} \tag{6.28}$$

Considering the modulus of inertia given by the three longitudinal layers (neglecting the contribution of the transverse layers), the elastic rotation was calculated for each step measured and subtracted from the total value recorded by the inclinometers (6.29).

$$\theta_{IM} = \theta_{tot} - \theta_{el} \tag{6.29}$$

Figure 248 shows a comparison between the direct output from the inclinometers θ_{tot} and the actual rotation θ_{IM} obtained by subtracting the elastic component θ_{el} .

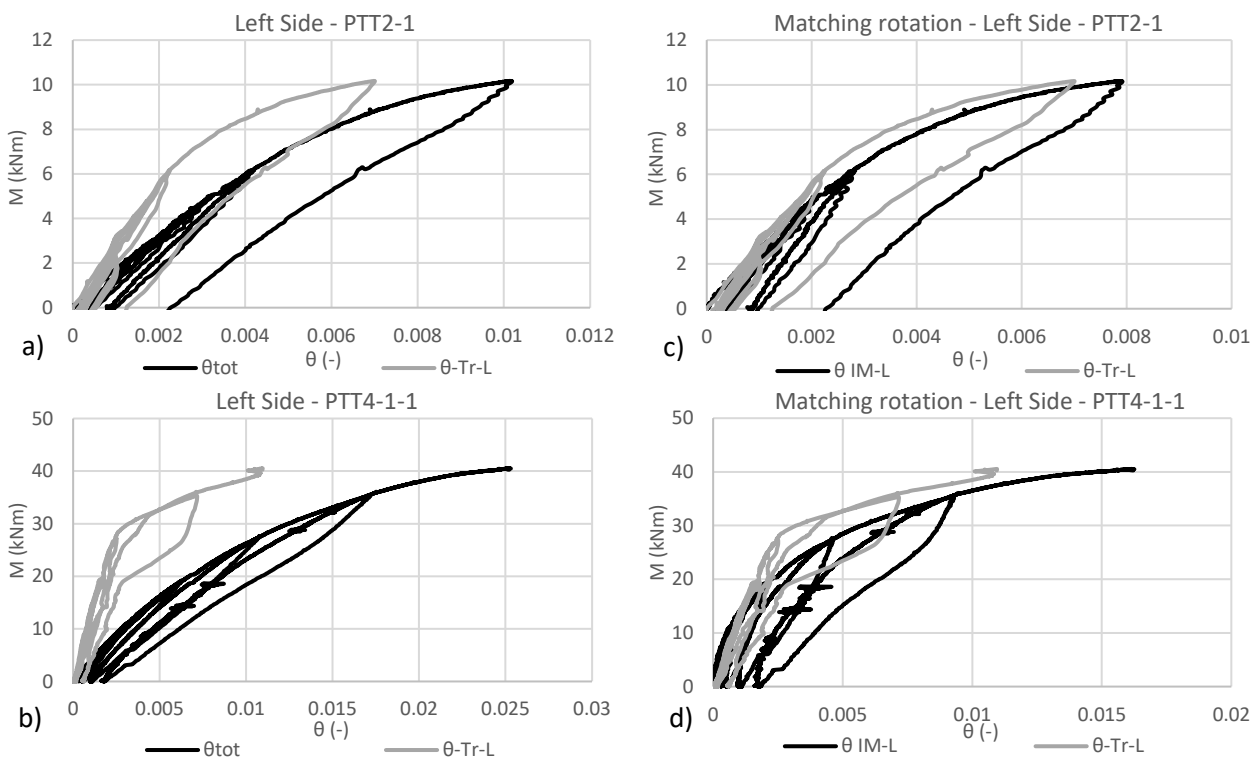

Figure 248 – a) and b) Comparisons between the rotations calculated with the transducers (θ_{Tr-L}) and the rotations obtained from the inclinometers (θ_{tot}), for the left sample of PTT2-1 and PTT4-1-1; c) and d) comparison between the rotations calculated with the transducers and the effective rotations (θ_{IM}) calculated, removing the elastic contribution from the same specimens

As shown in Figure 248, removing the elastic contribution from the rotation recorded by the inclinometers led to a matching of the rotations. For the specimens with steel widening plates (PTT4 and PTT5) the rotation from the transducers was often less than the actual rotation calculated with (6.28). It is in fact plausible that the rotation of the horizontal element was not fully transferred to the contact interface due to a deformation of the timber member within the angle plates. This event is further discussed in Sections 6.3.5.3 and 6.3.5.4.

Rotation calculated from the displacement of the vertical element

Finally, the rotation was estimated by dividing the vertical displacement measured by the transducers, placed under the vertical element (T_B) and the length of the horizontal element (L_b) considered between the support and the connection interface.

$$\theta_{TB,tot} = \frac{T_B}{L_b} \quad (6.30)$$

The values obtained from (6.30) have also been reduced by the elastic contribution calculated in (6.28) and affecting $\theta_{TB,tot}$.

After the evaluation of the initial compression, the rotations calculated by these three methods are compared for all the specimens analysed (Section 6.3.5).

6.3.4.3 Key variables

Tendon force

The tendon force is measured with the load cell placed between the anchor plate and the hydraulic cylinder (Figure 241). It was recorded during the entire test and manually restored before the start of each cycle to compensate for losses.

Moment

The moment affecting the connection was calculated as a function of the geometry of the specimen and the value of the force provided by the Zwick600 (6.31) and measured with the external load cell. The static scheme is simply represented by a supported beam with a concentrated load in the centre (Figure 249).

$$M = \frac{FL_b}{2} \quad (6.31)$$

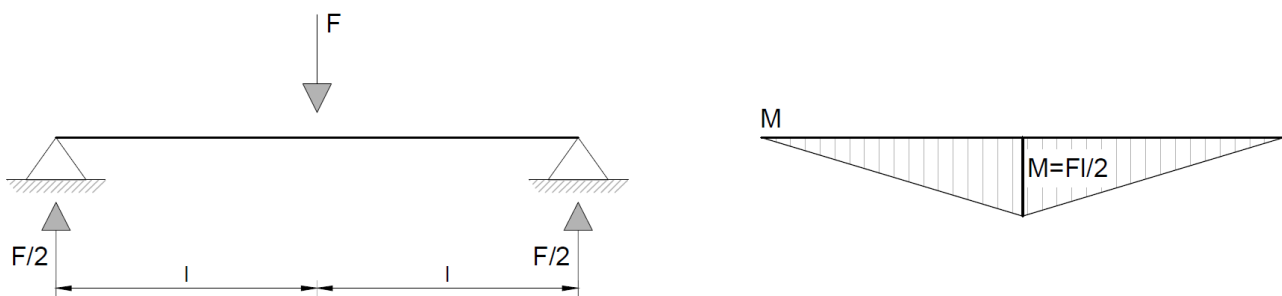

Figure 249 – Static scheme and moment diagram considered for the calculation of the moment at the interface of the PT-CLT connection test

Neutral axis depth

The depth of the neutral axis indicates the area of the interface in compression. With reference to [169] and Figure 246 the neutral axis (x) can be estimated using the slope of the interpolation function between the individual transducers with (6.32) for the specimen without steel widening plates (PTT2 and PTT3) and (6.33) for the others (PTT4 and PTT5). The best output between the values calculated from T1, T2 and T3 were used for this evaluation, although the values of the transducer located in the compression zone (T1) should not be considered acceptable due to the nonlinear behaviour of the material in high compressive forces [169].

$$\theta = \frac{y_{T1}}{(x-10)} = \frac{y_{T2}}{(100-x)} = \frac{y_{T3}}{(190-x)} \rightarrow x = 10 + \frac{y_{T1}}{\theta} = 100 - \frac{y_{T2}}{\theta} = 190 - \frac{y_{T3}}{\theta} \quad (6.32)$$

$$\theta = \frac{y_{T1}}{(x-20)} = \frac{y_{T2}}{(200-x)} = \frac{y_{T3}}{(380-x)} \rightarrow x = 20 + \frac{y_{T1}}{\theta} = 200 - \frac{y_{T2}}{\theta} = 380 - \frac{y_{T3}}{\theta} \quad (6.33)$$

The transducers outputs were imposed at the beginning of each cycle at the calculated initial compression values (Section 6.3.4.1) and the progressive variation was evaluated at each measured step to determine the position of the neutral axis. This procedure was carried out because the rigid displacement of the component during the prestressing phase would have compromised the analysis of the decompression moment.

Nonetheless, it was not possible to identify and “purify” the measurements from the rigid displacements that occurred during the rotation phase. The basic asymmetry imposed by the first compression phase, as well as the intrinsic asymmetry of the material and the geometries involved, compromised the evaluation of the transducers in the rotational phase leading to results such as those shown in Figure 250a.

For this reason, the neutral axis was calculated using formula (6.12) with the moment and post-tension data from the experiments’ measurements (respectively M_{meas} and P_{meas}).

$$x = 3 \cdot \left(\frac{h_b}{2} - \frac{M_{meas.}}{P_{meas.}} \right) \quad (6.34)$$

The results are given for both calculation methods in Section 6.3.5.

Maximum stresses in the vertical element

The compressive stresses perpendicular to the grain of the vertical timber element are the main design criterion and have been estimated on the basis of the experimental data as a function of the neutral axis exposed before. The compressive value ($\sigma_{perp.}$) is calculated at each step measured with (6.35) before decompression and with (6.36) after decompression [169].

$$\sigma_{perp} = \frac{P}{A_b} \pm \frac{M}{W_b} \quad (6.35)$$

$$\sigma_{perp} = \frac{2 \cdot P}{x \cdot b_b} \quad (6.36)$$

Since the stress values perpendicular to the grain depend on the depth of the neutral axis, it follows that the most accurate evaluation is made using the neutral axis values obtained with (6.34), as shown in Figures 250a and 250b. It was, in fact, possible to check the condition of the wood samples after the tests and to demonstrate that the values obtained, using the neutral axis calculated with (6.32) and (6.33), were inaccurate, presenting compressive values that would have certainly crushed the grain of the specimen at the edge of the interfaces of some specimens.

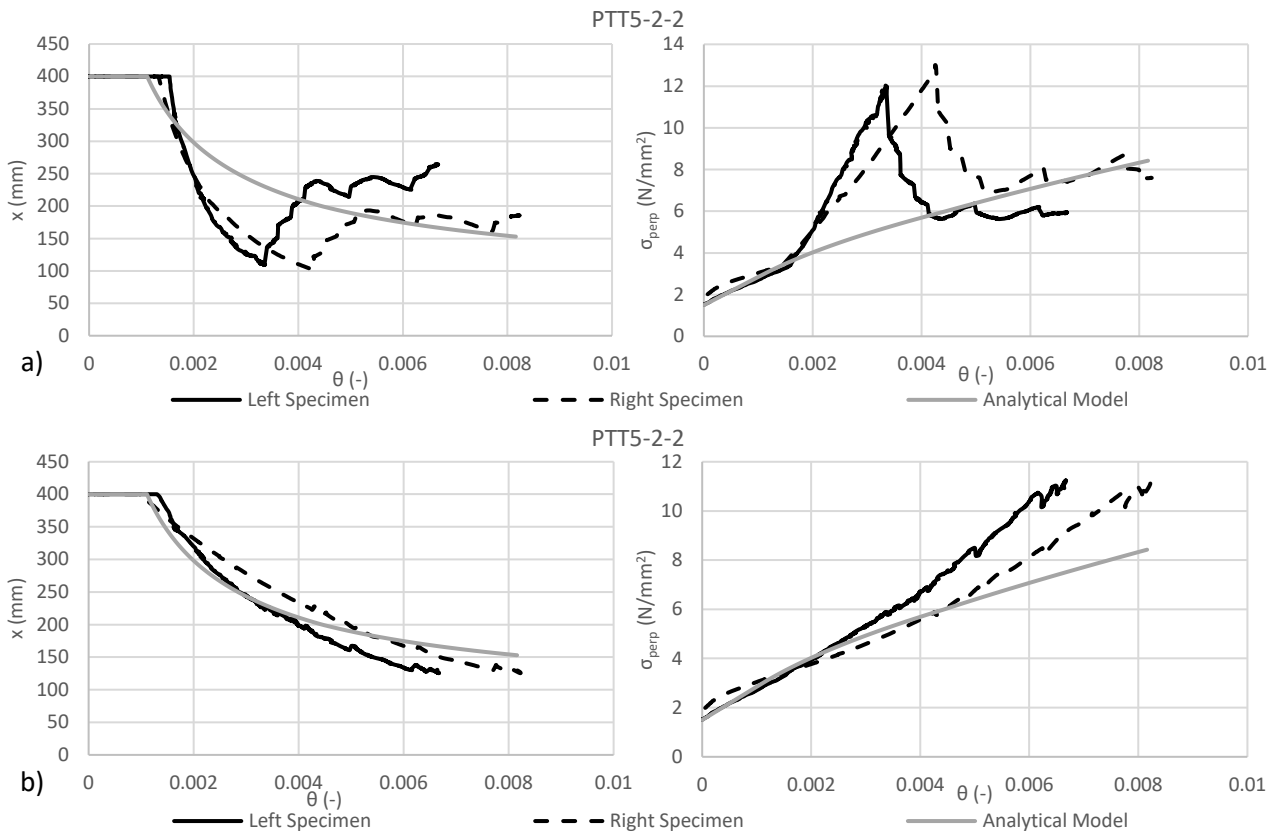

Figure 250 – a) Graphs showing the neutral axis and the stresses perpendicular to the vertical element for the sixth cycle of the PTT5-2-2, calculated with (6.33), (6.35) and (6.36); b) graphs showing the same values of the same test calculated with (6.34), (6.35) and (6.36)

Influence of the tendon elongation after decompression moment

As mentioned in Section 6.3.2.4, a threaded steel rod was used instead of a steel strand, resulting in a stronger connection behaviour due to an increase in the resisting area which allowed an increased tendon force in the specimens with steel widening plates (not limited by the initial compression perpendicular to the grain).

The use of the threaded rod on this specimen led to an unexpected behaviour that was taken into account when evaluating the accuracy of the analytical model. Looking at (6.37), it is evident that the elongation of the tendon is dependent on area and length of the tendon. In the tests described in the next section, the tendon is particularly short in relation to the cross-area, which has a relevant impact on the tendon elongation. Furthermore, the significance of ΔP becomes greater with lower values of the initial tendon force (P_0).

$$P = P_0 + \Delta P = P_0 + \frac{A_p \cdot E_p \cdot \Delta L}{L_p} \quad (6.37)$$

In order to investigate the accuracy of the analytical model, the influence of tendon elongation due to the vertical displacement of the wall element (T_B) has been considered. The elongation due to rotation at the interface could in fact be covered by the elongation due to greater vertical displacements than a relatively short L_p .

Considering the vertical displacement values given by the transducers placed under the wall element (T_B) and also taking into account the length of the horizontal elements (L_b), it was possible to obtain the elongation of the tendon due to the vertical displacement (ΔL_{VD}).

$$\Delta L_{VD} = L_{b'} - L_b = \sqrt{L_b^2 + T_B^2} - L_b \quad (6.38)$$

ΔL_{VD} , was then used to evaluate the contribution on the tendon force due to the vertical displacement ΔP_{VD} (6.39) and subtracted from the measured value of the prestressing force (6.40) to better match the results of the analytical model.

$$\Delta P_{VD} = \frac{A_P \cdot E_P \cdot \Delta L_{VD}}{L_P} \quad (6.39)$$

$$P_{eff} = P - \Delta P_{VD} \quad (6.40)$$

Through the use of (6.41), it was finally possible to verify the results of the moments obtained from the tests against the analytical model after the moment of decompression.

$$M = P_{eff} \cdot \left(\frac{h_b}{2} - \sqrt{\frac{2}{9} \cdot \frac{P_{eff}}{b \cdot c \cdot \vartheta}} \right) \quad (6.41)$$

This procedure led the results of the experiments to coincide with the analytical model and is reported for each cycle exposed in Section 6.3.5.

Lower values of the tendon force imply a higher sensitivity to rotation that easily reaches the decompression moment without implying plastic deformation of the compressed zone (lower values of the tendon force were intentionally avoided for weaker wood samples). In this case, another approach could be to change the analytical model to include tendon elongation immediately after the decompression moment. This theory could be confirmed by the fact that tendon elongation starts after decompression and not when the neutral axis reaches the position of the tendon. To adapt the analytical model to this case, the iterative procedure provided to determine the behaviour of the connection with tendon elongation should be anticipated to the second phase and evaluate the tendon elongation, as proposed in (6.38), until the neutral axis reaches the tendon position and as (6.42) when it exceeds it ($\Delta P_{3rd\ phase}$).

$$\Delta P_{3rd\ phase} = A_P \cdot E_P \cdot \left(\frac{\theta \cdot (d-x) + \Delta L_{VD}}{L_P} \right) \quad (6.42)$$

This alternative analytical approach is evaluated indirectly by considering the first approach and matching the results of the experiments with the existing analytical model and therefore, considering the contribution of the additional tendon elongation as subtracted by the test results.

Another contribution that influenced the tendon behaviour is the small space available in the cavities of the wooden pieces. Considering a rod diameter of 30 mm and the holes of 40 mm, only 5 mm were provided above and below the tendon. This fact was considered for the stress safety calculation in the threaded rod, leading to additional variables in the evaluation of tendon elongation in the experiments.

Further analysis would be required on this topic, considering the influence of the threaded rod with respect to the strands and the use of different and higher tendon force values on the same specimens.

6.3.5 Evaluation of the experimental tests and comparison with the analytical model

The experimental campaign counted 29 tests varying the central element, the prestressing force, the presence of the steel widening plates and the load cycles. One test for each type (PTT2, PTT3, PTT4 and PTT5) is presented in this chapter, analysing them in the following order:

- initial compression
- rotation at the interface
- most relevant cycle and comparison with the analytical model
- additional typology considerations, including similar tests

At the beginning of each section, the value of modulus of elasticity perpendicular to the grain (E_{90}) is reported. The value assigned was always the average value obtained from the mechanical tests presented in Section 6.3.1, except for a few cases shown below.

6.3.5.1 PTT2-1

Figure 251 – Frontal photo showing the setup of the PTT2

Table 193 – Load cycles for the PTT2-1 test; the effective vertical loads are reported together with the maximum moment at the interface and the decompression moment measured; moisture content and density values are also reported in relation to the central wall element (CLT)

Cycle	Type	Load (kN)	Eff. Load (kN)	M_{max} (kNm)	M_{dec} (kNm)
0	Prestr.	150	150	-	-
1	Load.	15	13.72	3.43	-
2	Load.	20	21.04	5.26	5.01
3	Load.	25	26.64	6.66	5.03
4	Load.	40	42.44	10.61	5.04
5	Load.	55	59.52	14.88	5.03
6	Load.	-	-	-	-
Moisture content (%)				$\omega = 10.7$	
Density (kg/m³)				$\rho = 436.03$	

The value of modulus of elasticity perpendicular to the grain (E_{90}) considered to match the analytical model is taken as the maximum value obtained from the mechanical tests (Section 6.3.1), implying the following modulus of subgrade reaction (c).

$$E_{90} = 970 \text{ MPa}; \quad c = \frac{E_{90} \cdot 2}{b_c} = 9.7$$

Initial compression

With reference to Section 6.3.4.1, the transducer outputs at the left and right interfaces can be plotted as shown in Figure 245. The average values of the outputs from the left and right interfaces (T-LM and T-RM, respectively) can be plotted along with the mean deformation of both samples as a visual representation of the Δc (T-M in Figure 252).

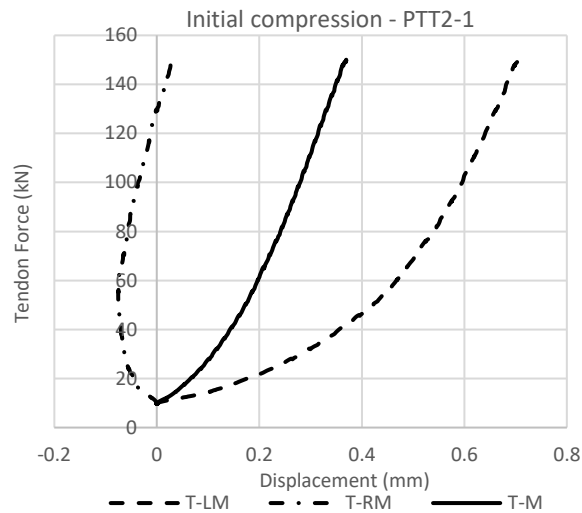

Figure 252 – Mean value of the transducer outputs of the left (T-LM) and right (T-RM) sides of the vertical element for PTT2-1 during the prestressing phase; T-M represents the average between the values obtained from the two sides, coinciding with Δc

With (6.43) the mean deformation at the single interface is then evaluated and compared with the value obtained using the simplified spring model (6.44) [169].

$$w_{mean} = \frac{\Delta c}{2} = 0.19 \text{ mm} \tag{6.43}$$

$$\Delta l = \frac{N \cdot l}{E \cdot A} = \frac{P_0}{A_b \cdot E_{90}} \cdot \frac{b_c}{2} = \frac{150 \cdot 000}{100 \cdot 000 \cdot 970} \cdot \frac{200}{2} = 0.16 \text{ mm} \tag{6.44}$$

The measured value is slightly higher than the calculated one with the simplified spring model.

Due to the rigid displacement of the entire specimen during the prestressing phase, it was only possible to extrapolate an average value from the transducer results without having the possibility of characterising the contribution of the individual sides of the specimen.

Rotation at the interface

The rotation values obtained from the measurement are compared with each other, using the three methods exposed in Section 6.3.4.2 (Figure 253).

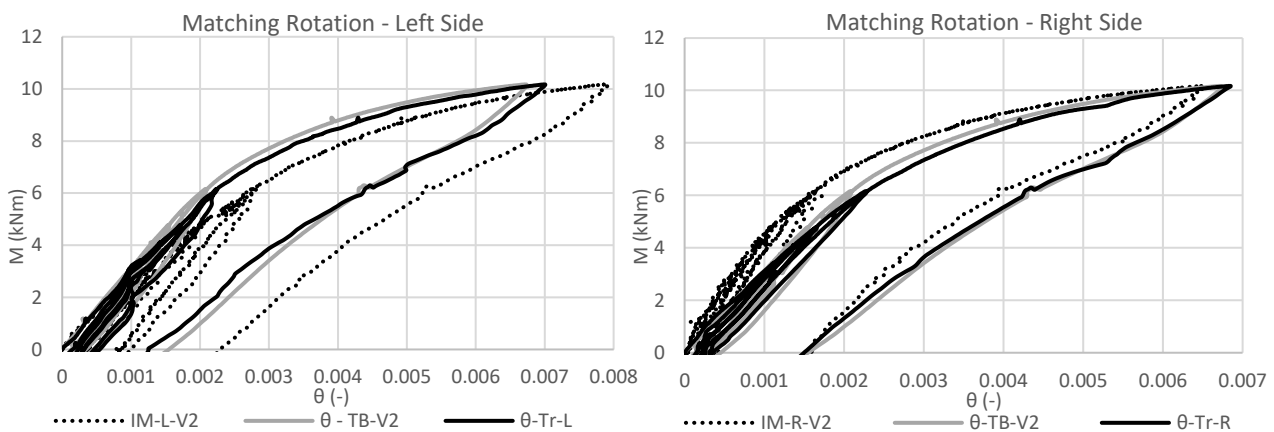

Figure 253 – PTT2-1 moment-rotation curves for the left and right sides; comparison is made for the values obtained from the lateral transducers (ϑ -Tr) the lower transducer (ϑ -TB), and the inclinometers (IM)

The rotation calculated with the output of the inclinometers (IM-V2) resulted larger for the left horizontal piece and smaller for the right one when compared to the rotation (θ -TB). Considering the rigid displacement of the specimen in one direction (to the right when looking at the initial compression plots (Figure 245), it is likely that the left horizontal piece had a larger span than the right and was found to have greater rotations. The rotation measured by the lateral transducers (θ -Tr), on the other hand, was aligned at both interfaces and matched the single rotation calculated from the measured vertical displacement (θ -TB).

Cycle 4

The fourth cycle was isolated in the loading phase, and the evaluations introduced in Section 6.3.4.3 led to the determination of the moment, tendon force, neutral axis, and stress perpendicular to the grain in relation to the rotation obtained from the lateral transducers (θ -Tr). In all graphs shown, the results of the analytical model are plotted together with the output of the left and right sides.

While Figure 254 shows the results considering the neutral axis (x) calculated by the lateral transducers (6.32), Figure 255 gives the results obtained, using (6.34) with the measured values of moment and tendon force. It also shows the influence of tendon elongation for the phase after decompression.

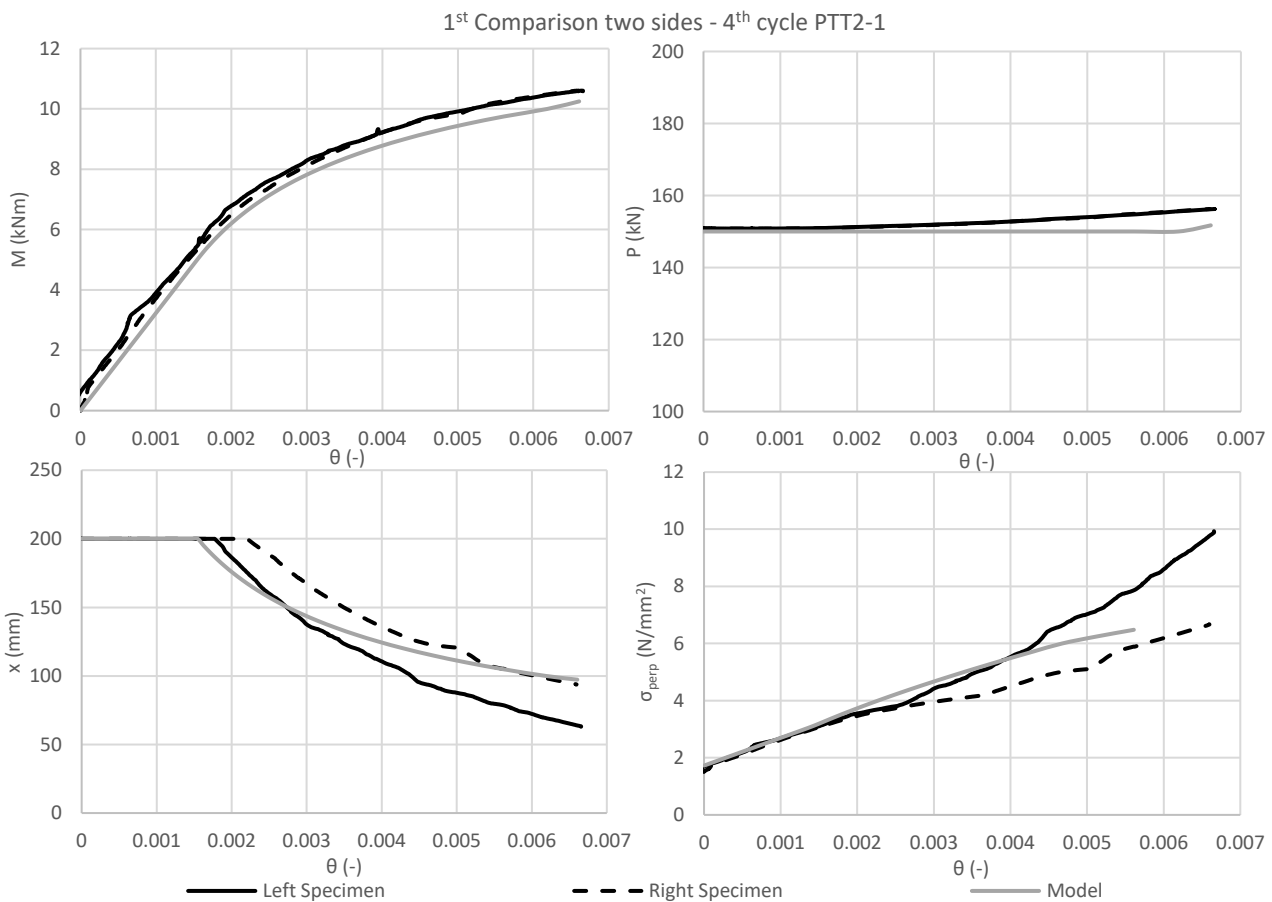

Figure 254 – Evaluation of PTT2-1 showing the moment-rotation behaviour, tendon force, stresses at the interface and neutral axis depth proceeding from the left corner in clockwise direction; the neutral axis is calculated with (6.32); the grey curves represent the prediction of the analytical model

For PTT2-1, the evaluation, made with the neutral axis (x) and calculated with (6.32), gave acceptable results, which corresponded to the behaviour obtained from the analytical model which considers an increased modulus of elasticity in the direction perpendicular to the grain (σ_{perp}).

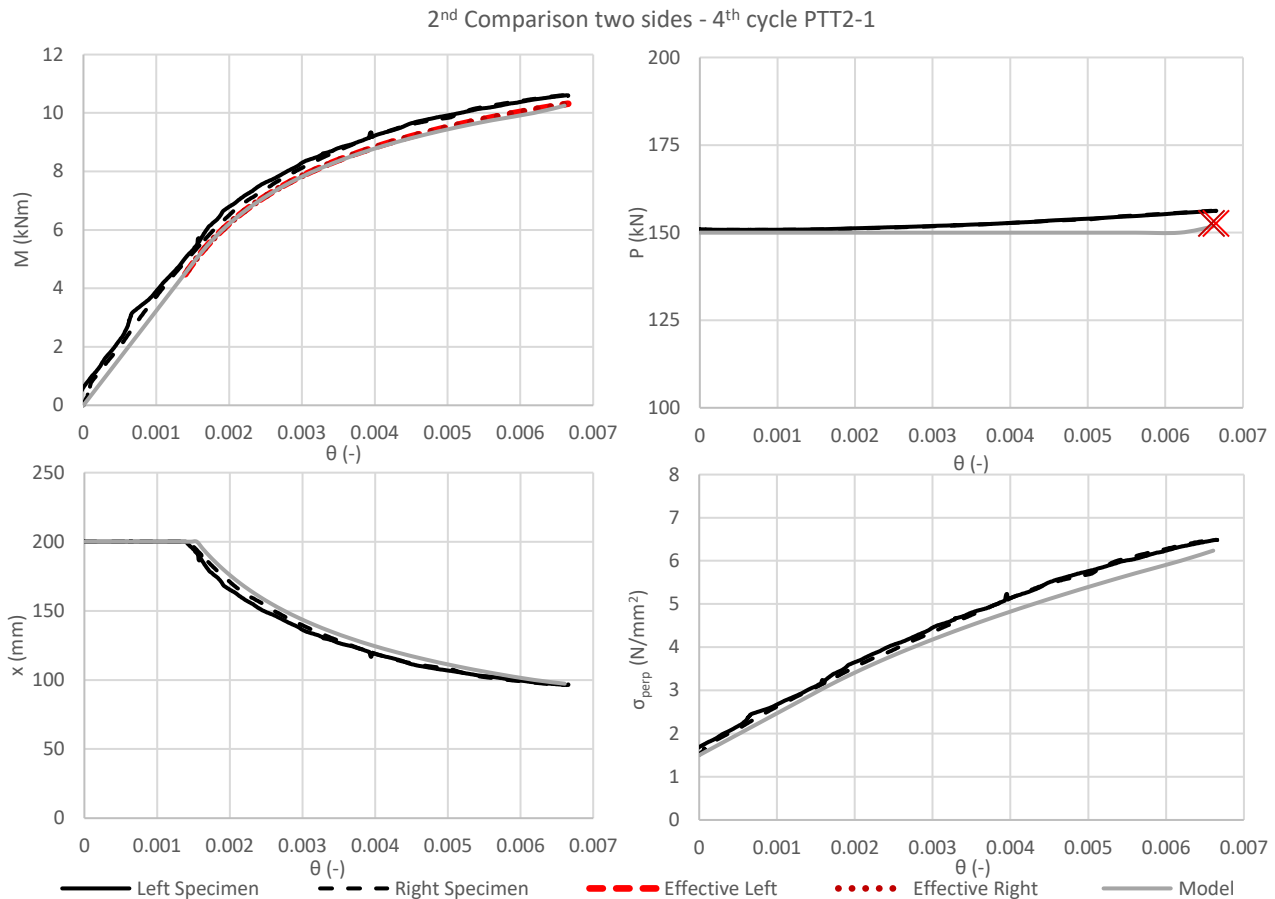

Figure 255 – Evaluation of PTT2-1 showing the moment-rotation behaviour, tendon force, stresses at the interface and neutral axis depth proceeding from the left corner in clockwise direction; the neutral axis is calculated with (6.34); the grey curves represent the prediction of the analytical model, while the red curves and crosses indicate the influence of the tendon elongation for the right (Effective Right) and left (Effective Left) samples

Figure 255 shows that the results of the analytical model are comparable with the measured values. Furthermore, the influence of tendon elongation due to the use of the threaded steel rod is confirmed to correlate the deviation of the tendon force increase to the deviation on the behaviour. This fact is evident in the moment-rotation curve for the decompression phase (dashed red lines) and for the tendon force, shown by the red crosses indicating the value of P without the contribution calculated with (6.39).

Additional notes on PTT2

The high modulus of elasticity used in PTT2-1 was also used for PTT2-2 and PTT2-3 because for all three cases the measured values were stiffer than the behaviour given by the analytical model with the mean modulus calculated with the mechanical tests. Figure 256 compares the moment-rotation behavioural law of the fourth cycle of PTT2-2 with the analytical model calculated with the mean value ($E_{90,mean}$) and the maximum value ($E_{90,max}$) of the stiffness perpendicular to the grain, compared to the results of the mechanical tests. A possible explanation could be the low prestressing force applied to the specimens with a consequent value of stiffness depending on the initial part of the material behavioural law. It is in fact evident from Figure 233 that the initial stiffness of the material in compression is comparable to that measured by the LVL-R samples, especially when low compression is applied symmetrically on both sides of the element. The choice of this value of initial tendon force was dictated by the intention to avoid crushing of the grain before the start of rotation and the consequent application of the moment.

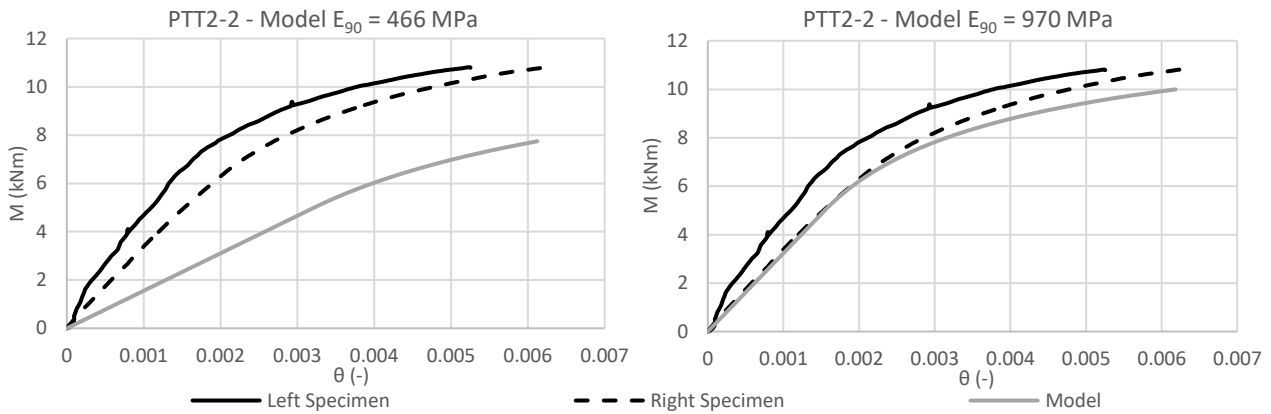

Figure 256 – Moment-rotation curves of the fourth cycle of the PTT2-2 showing the comparison with analytical model providing $E_{90,mean}$ (left) and $E_{90,max}$ (right)

Observing Figure 253, it can be noticed that the connection guarantees a re-centring behaviour for the first three cycles, with low or no residual deformation, and a confirmed stiffness for the loading phases. As shown in Figures 257a and b, the re-centring behaviour is guaranteed at each cycle, even if the crushing of the grain and the consequent plastic deformation at the interface do not allow a complete return to the initial position. However, it is worth mentioning that even considering a plastic deformation after the fourth cycle, which indicates the failure and the crushing of the grain at the interface (Figures 257c and d), the PT connection maintains the same stiffness during the fifth loading phase, ensuring a good performance after the failure.

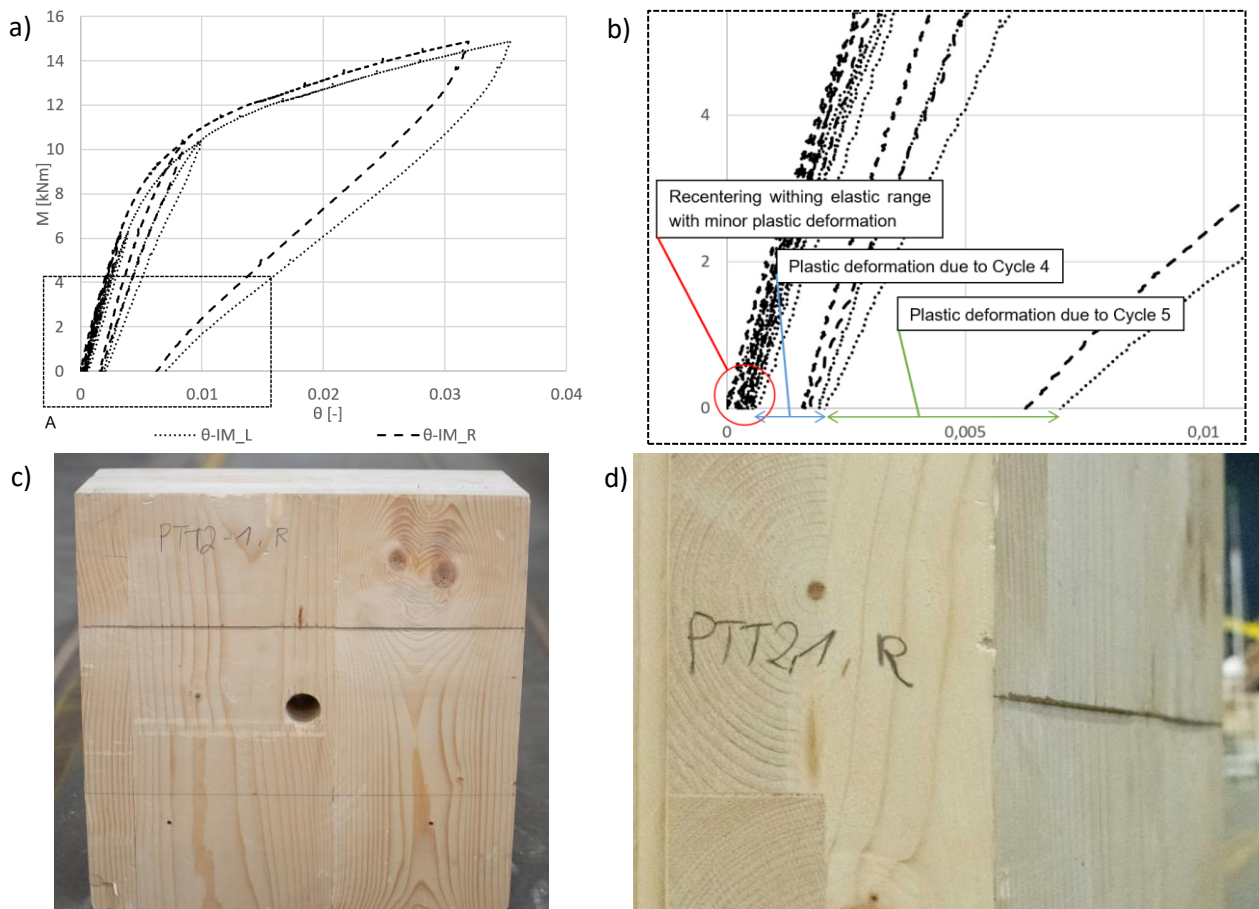

Figure 257 – a) Measured moment-rotation curves of the left and right side of the PTT2-3, considering the output of the inclinometers, not compromised by the rigid deformation; b) focus A of the residual deformation shown in Figure 257a; c) and d) photos of the wall sample of PTT2-1 after the test, showing crushed grain on both the upper left and right sides – Source: [208]

6.3.5.2 PTT3-1



Figure 258 – Frontal photo showing the setup of the PTT3

Table 194 – Load cycles for the PTT3-1 test; the effective vertical loads are reported together with the maximum moment at the interface and the decompression moment measured; moisture content and density values are also reported in relation to the central wall element (LVL-R)

Cycle	Type	Load (kN)	Eff. Load (kN)	M_{max} (kNm)	M_{dec} (kNm)
0	Prestr.	220	220	-	-
1	Load.	30	32.36	8.09	7.35
2	Load.	50	53.12	13.28	7.32
3	Load.	70	74.84	18.71	7.37
4	Load.	80	85.20	21.30	7.37
5	Load.	-	-	-	-
6	Load.	-	-	-	-
Moisture content (%)				$\omega = 10$	
Density (kg/m³)				$\rho = 653.98$	

The value of modulus of elasticity perpendicular to the grain (E_{90}) considered to match the analytical model is taken as the mean value obtained from the mechanical tests (Section 6.3.1), implying the following modulus of subgrade reaction (c).

$$E_{90} = 675 \text{ MPa}; \quad c = \frac{E_{90} \cdot 2}{b_c} = 6.75$$

Initial compression

With reference to Section 6.3.4.1, the transducer outputs at the left and right interfaces can be plotted as shown in Figures 259. The average values of these outputs (T-LM and T-RM) can be plotted along with the mean deformation of both samples as a visual representation of the Δc (T-M in Figure 259c).

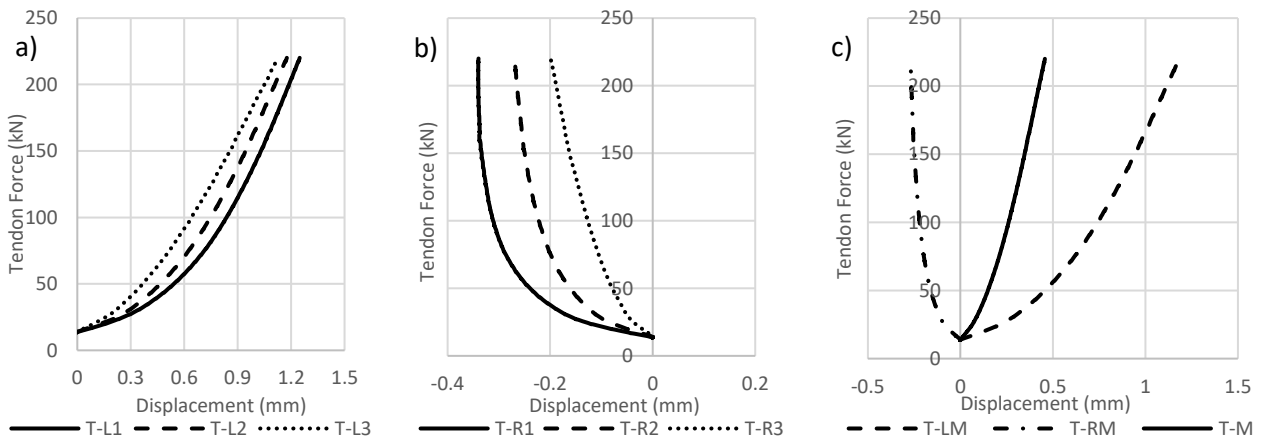

Figure 259 – a) output of the transducers on the left side of the vertical element for PTT3-1; T-L1, T-L2 and T-L3 represent the three transducers placed from top to bottom respectively; b) output of the transducers on the right side of the vertical element for PTT3-1; c) mean value of the transducer outputs of the left (T-LM) and right (T-RM) sides, together with their average (T-M), coinciding with Δc for the vertical element of PTT3-1

With (6.45) the mean deformation at the single interface is then evaluated and compared with the value obtained, using the simplified spring model (6.46) [169].

$$w_{mean} = \frac{\Delta c}{2} = 0.23 \text{ mm} \quad (6.45)$$

$$\Delta l = \frac{N \cdot l}{E \cdot A} = \frac{P_0}{A_b \cdot E_{90}} \cdot \frac{b_c}{2} = \frac{220 \cdot 1000}{100 \cdot 1000 \cdot 675} \cdot \frac{200}{2} = 0.33 \text{ mm} \quad (6.46)$$

The measured value is lower than that calculated with the simplified spring model. However, more accurate results were recorded for the second (PTT3-2) and third sample (PTT3-3) with prestressing deformation of 0.30 and 0.29, respectively.

Due to the rigid displacement of the entire specimen during the prestressing phase, it was only possible to extrapolate an average value from the transducer results without having the possibility of characterising the contribution of the individual sides of the specimen.

Rotation at the interface

The rotation values obtained from the measurement are compared with each other, using the three methods exposed in Section 6.3.4.2 (Figure 260).

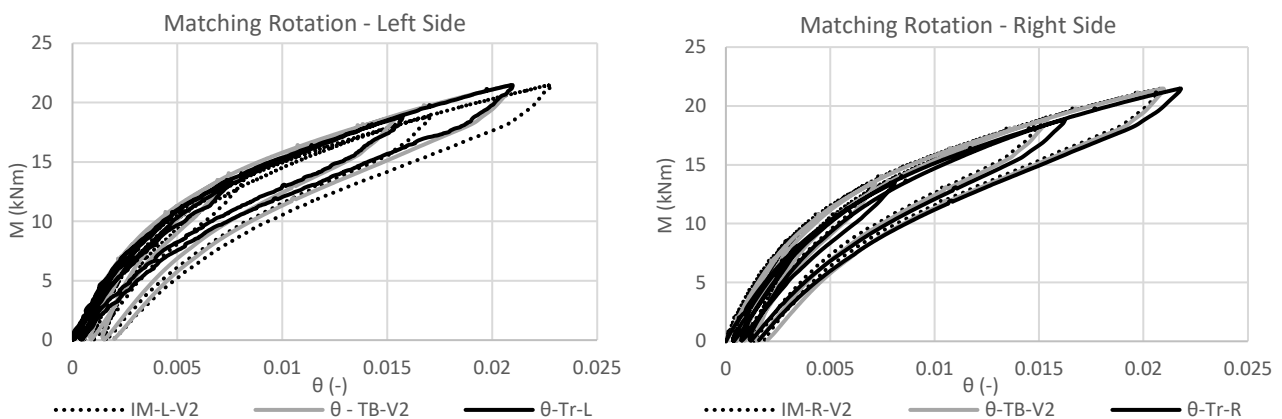

Figure 260 – PTT3-1 moment-rotation curves for the left and right sides; comparison is made for the values obtained from the lateral transducers (θ -Tr), the lower transducer (θ -TB), and the inclinometers (IM)

The rotation calculated with the output of the inclinometers (IM-V2) resulted aligned at both interfaces with the values obtained from the lateral transducers (θ -Tr), and from the measured vertical displacement (θ -TB).

Cycle 3

The third cycle was isolated in the loading phase, and the evaluations introduced in Section 6.3.4.3 led to the determination of the moment, tendon force, neutral axis, and stress perpendicular to the grain in relation to the rotation obtained from the lateral transducers (θ -Tr). In all graphs shown, the results of the analytical model are plotted together with the output of the left and right sides.

While Figure 261 shows the results, considering the neutral axis (x) and calculated by the lateral transducers (6.32), Figure 262 gives the results obtained, using (6.34) with the measured values of moment and tendon force. Figure 262 also shows the influence of tendon elongation for the phase after decompression.

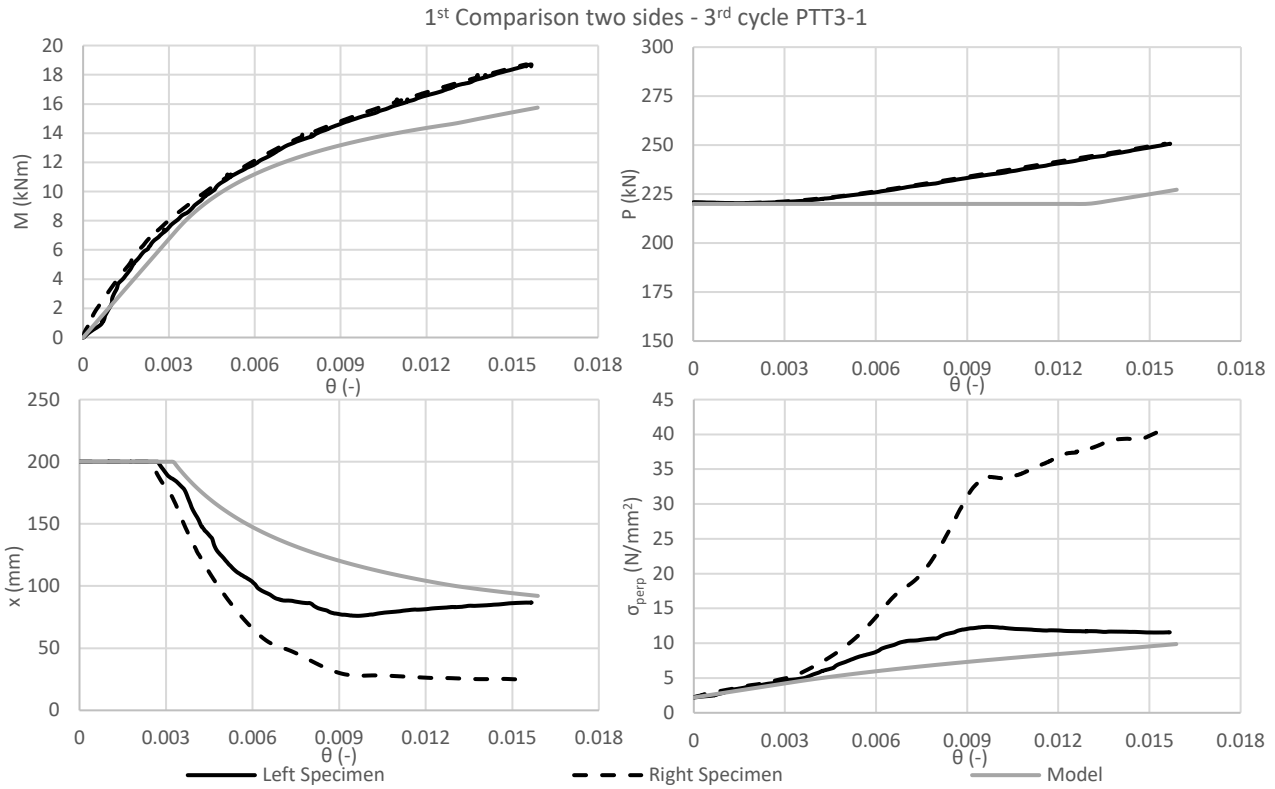

Figure 261 – Evaluation of PTT3-1 showing the moment-rotation behaviour, tendon force, stresses at the interface and neutral axis depth proceeding from the left corner in clockwise direction; the neutral axis is calculated with (6.32); the grey curves represent the prediction of the analytical model

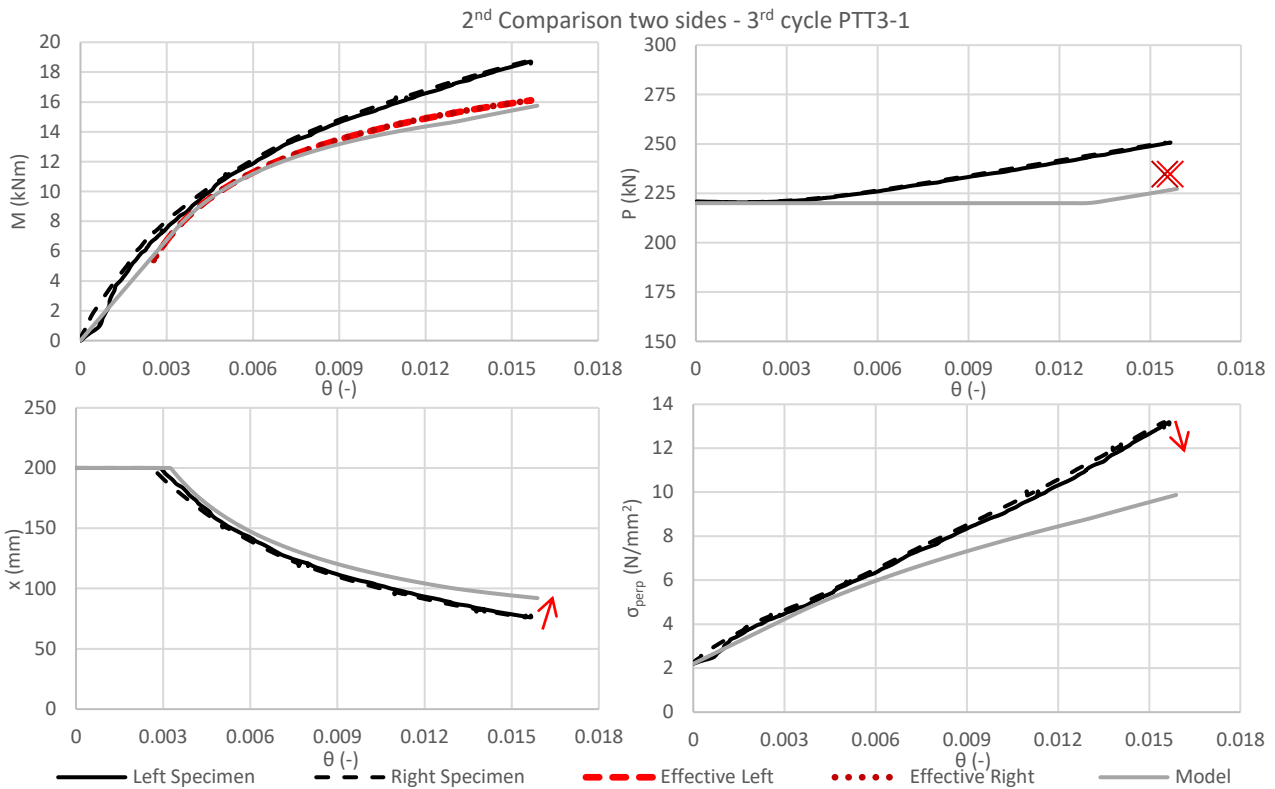

Figure 262 – Evaluation of PTT3-1 showing the moment-rotation behaviour, tendon force, stresses at the interface and neutral axis depth proceeding from the left corner in clockwise direction; the neutral axis is calculated with (6.34); the grey curves represent the prediction of the analytical model, while the red curves and crosses indicate the influence of the tendon elongation for the right and left samples

Figure 261 shows that the neutral axis (x) calculated with the lateral transducer displacements, although close to the determination of the rotation corresponding to decompression, does not provide accurate results as the rotation values increase, especially for the right-hand sample. This is confirmed by the resulting unrealistic values of the stresses perpendicular to the grain (σ_{perp}), which would have led to visible crushing on the wall samples. On the other hand, the values calculated with (6.34) in Figure 262 are more reliable and in accordance with the analytical model, until the deviation of the tendon force becomes too significant. In fact, Figure 262 shows the influence of the tendon elongation due to the use of the short-threaded rod. The removal of this contribution from the measured values enabled the correspondence with the expected values with regard to the determination of the moment-rotation curve. Calculating the contribution of the elongation on the tendon force (P) at the maximum rotation also resulted in values close to those expected.

As consequence of a smaller increase in tendon force, the moment capacity was shown to decrease, the depth of the neutral axis would decrease less when implying lower values of stress perpendicular to the grain (arrows in Figure 262), confirming that no failure was occurring after this type of test.

Additional notes on PTT3

While for sample PTT3-1 the use of the mean value of the modulus of elasticity in compression perpendicular to the grain ($E_{90,mean} = 675 \text{ MPa}$) corresponded to the stiffness of the connection for the analytical model, for PTT3-2 and PTT3-3 it was necessary to use values between the mean and the maximum values ($E_{90,PTT3-2} = 800 \text{ MPa}$ and $E_{90,PTT3-3} = 930 \text{ MPa}$). Therefore, also for PTT3, the prediction of the analytical model using the mean values of the manufacturers would have led to conservative results. As described for the PTT2 specimens, the reason could be found in the low value of the applied initial prestressing force.

Looking at Figure 260, it can be noticed that the connection provides a re-centring behaviour at all cycles, with low or no residual deformation, and a confirmed stiffness for the loading phases. As shown in Figure 263, apart from a slightly visible indentation, no crushing of the perpendicularly compressed grain was visible in the sample after the test.



Figure 263 – Photos of the PTT3-3 wall sample after the test, no significant damage was observed (as for all similar samples)

6.3.5.3 PTT4-2-1

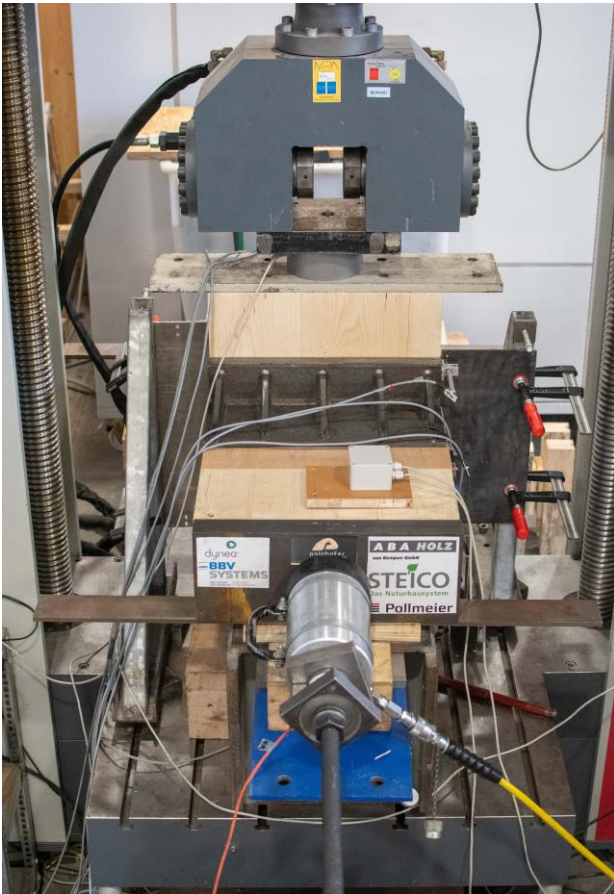

Table 195 – Load cycles for the PTT4-2-1 test; the effective vertical loads are reported together with the maximum moment at the interface and the decompression moment measured; moisture content and density values are also reported in relation to the central wall element (CLT)

Cycle	Type	Load (kN)	Eff. Load (kN)	M_{max} (kNm)	M_{dec} (kNm)
0	Prestr.	220	220	-	-
1	Load.	40	38.98	10.33	-
2	Load.	70	74.6	19.68	14.89
3	Load.	100	106.0	28.09	14.83
4	Load.	130	139.17	36.88	14.96
5	Load.	150	160.72	42.59	14.90
6	Load.	-	-	-	-
Moisture content (%)				$\omega = 10.9$	
Density (kg/m³)				$\rho = 422.25$	

Value of the modulus of elasticity perpendicular to the grain (E_{90}) considered to match the analytical model is taken as the mean value obtained from the mechanical tests (Section 6.3.1), implying the following modulus of subgrade reaction (c).

$$E_{90} = 466 \text{ MPa}; \quad c = \frac{E_{90} \cdot 2}{b_c} = 4.7$$

Figure 264 – Frontal photo showing the setup of the PTT4

Initial compression

With reference to Section 6.3.4.1, the transducer outputs at the left and right interfaces can be plotted as shown in Figures 265. The average values of these outputs (T-LM and T-RM) can be plotted along with the mean deformation of both samples as a visual representation of the Δc (T-M in Figure 265c).

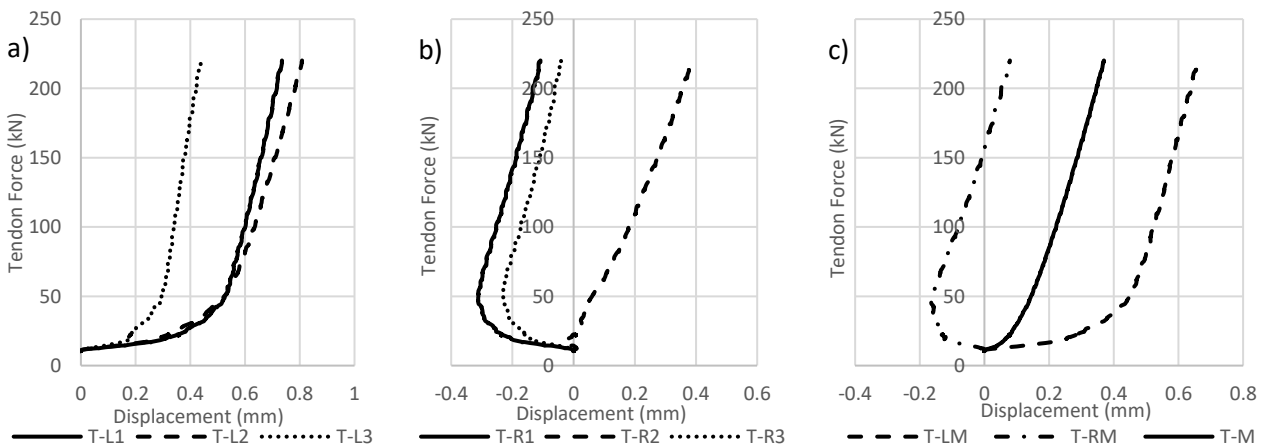

Figure 265 – a) output of the transducers on the left side of the vertical element for PTT4-2-1; T-L1, T-L2 and T-L3 represent the three transducers placed from top to bottom respectively; b) output of the transducers on the right side of the vertical element for PTT4-1-1; c) mean value of the transducer outputs of the left (T-LM) and right (T-RM) sides, together with their average (T-M), coinciding with Δc for the vertical element of PTT4-2-1

With (6.47) the mean deformation at the single interface is then evaluated and compared with the value obtained using the simplified spring model (6.48) [169].

$$w_{mean} = \frac{\Delta c}{2} = 0.19 \text{ mm} \quad (6.47)$$

$$\Delta l = \frac{N \cdot l}{E \cdot A} = \frac{P_0}{A_b \cdot E_{90}} \cdot \frac{b_c}{2} = \frac{220 \cdot 000}{200 \cdot 000 \cdot 466} \cdot \frac{200}{2} = 0.24 \text{ mm} \quad (6.48)$$

The measured value is slightly lower than the one calculated with the simplified spring model.

Due to the rigid displacement of the entire specimen during the prestressing phase, it was only possible to extrapolate an average value from the transducer results without having the possibility of characterising the contribution of the individual sides of the specimen.

Rotation at the interface

Also here, the rotation values obtained from the measurement are compared with each other, using the three methods exposed in Section 6.3.4.2 (Figure 266).

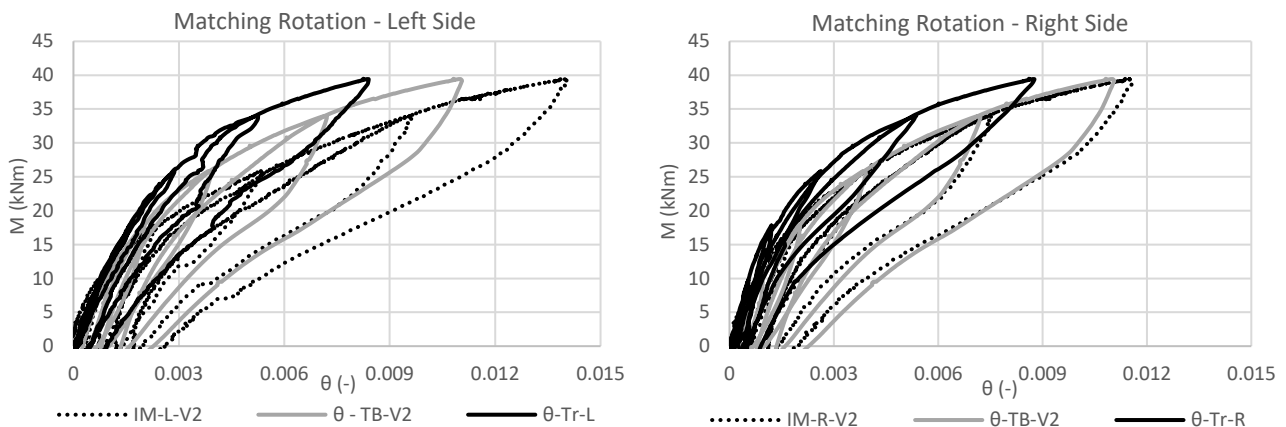

Figure 266 – PTT4-2-1 moment-rotation curves for the left and right sides; comparison is made for the values obtained from the lateral transducers (ϑ -Tr), the lower transducer (ϑ -TB), and the inclinometers (IM)

The rotation calculated with the output of the inclinometers (IM-V2) result larger for the left horizontal piece than for the right one. Considering the rigid displacement of the specimen in one direction (to the right when looking at the initial compression plots in Figure 265), it is likely that the left horizontal piece had a larger span than the right piece and was found to have greater rotations. The rotation measured by the lateral transducers (ϑ -Tr), on the other hand, was aligned at both interfaces and matched the single rotation, calculated from the measured vertical displacement (ϑ -TB) for the first elastic part of the rotation, only to be slightly lower on both sides of the specimen at later stages, certainly due to the rotation of the horizontal CLT pieces within the steel angle profiles. The latter were designed to provide only one millimetre per side in order to allow precise insertion of the timber element (Figure 237). However, the delivered parts had deformations on the long side of the L due to the welded connection of the stiffening plates on the other sides which slightly bent the plates. This, plus the elastic rotation of the wooden element, which is not fully transferred to the contact interface, caused the measurement difference.

This behaviour was recurrent during all tests with the steel widening plates, sometimes more noticeable than on others.

Cycle 5

The fifth cycle was isolated in the loading phase, and the evaluations introduced in Section 6.3.4.3 led to the determination of the moment, tendon force, neutral axis, and stress perpendicular to the grain in relation to the rotation obtained from the lateral transducers (θ -Tr). In all graphs shown, the results of the analytical model are plotted together with the output of the left and right sides.

While Figure 267 shows the results considering the neutral axis (x) calculated by the lateral transducers (6.33), Figure 268 gives the results obtained, using (6.34) with the measured values of moment and tendon force. Figure 268 also shows the influence of tendon elongation for the phase after decompression.

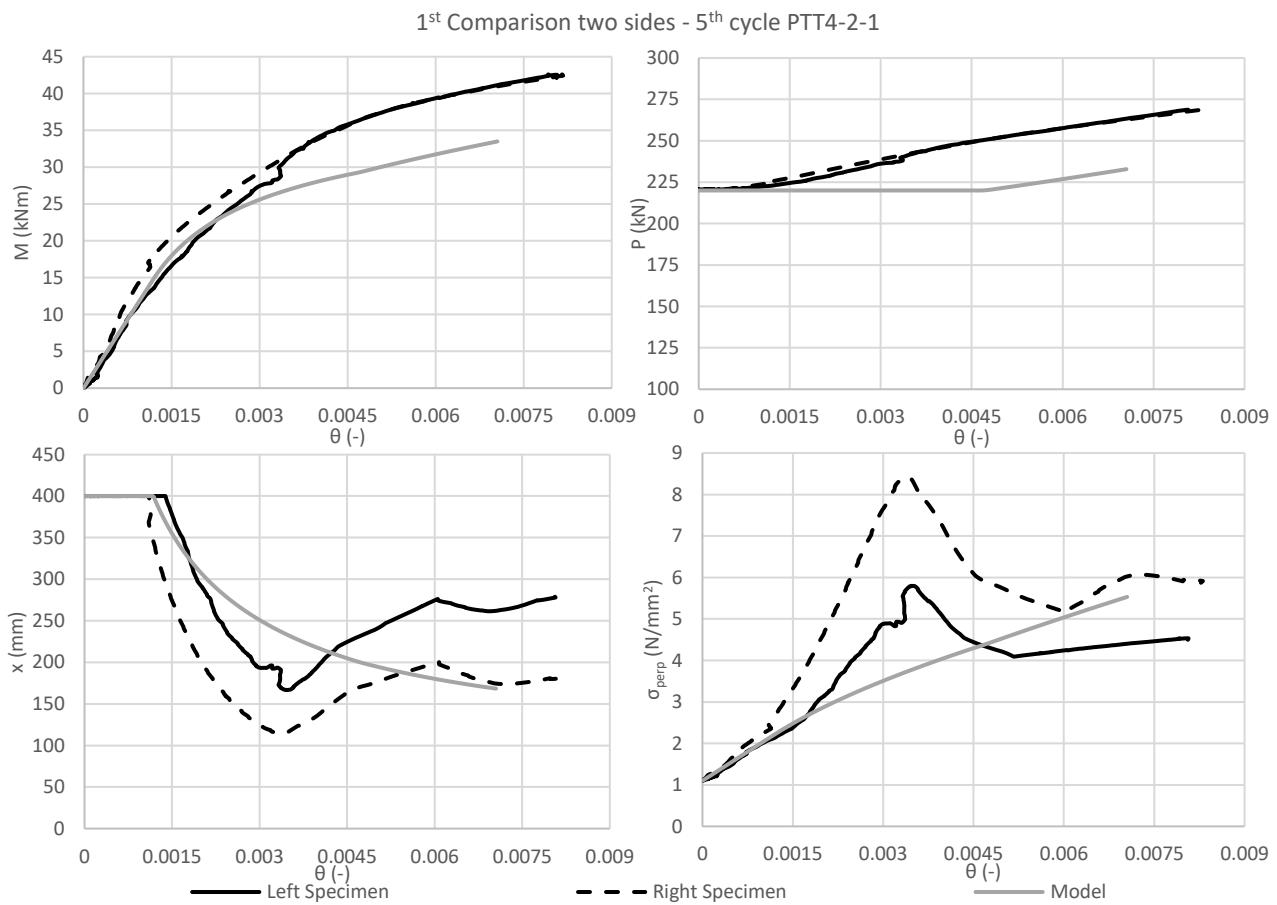

Figure 267 – Evaluation of PTT4-2-1 showing the moment-rotation behaviour, tendon force, stresses at the interface and neutral axis depth proceeding from the left corner in clockwise direction; the neutral axis is calculated with (6.33); the grey curves represent the prediction of the analytical model

The moment-rotation behaviour is well predicted until the influence of the tendon force increase becomes too significant and leads to an underestimation of the connection capacity. This contribution has been considered in Figure 268.

The neutral axis (x) calculated with the lateral transducer displacements (Figure 267), although close to the determination of the rotation corresponding to decompression (M_{dec}), does not provide accurate results as the rotation values increase. This is confirmed by the resulting unrealistic values of the stresses perpendicular to the grain (σ_{perp}), which would have led to visible crushing on the wall samples.

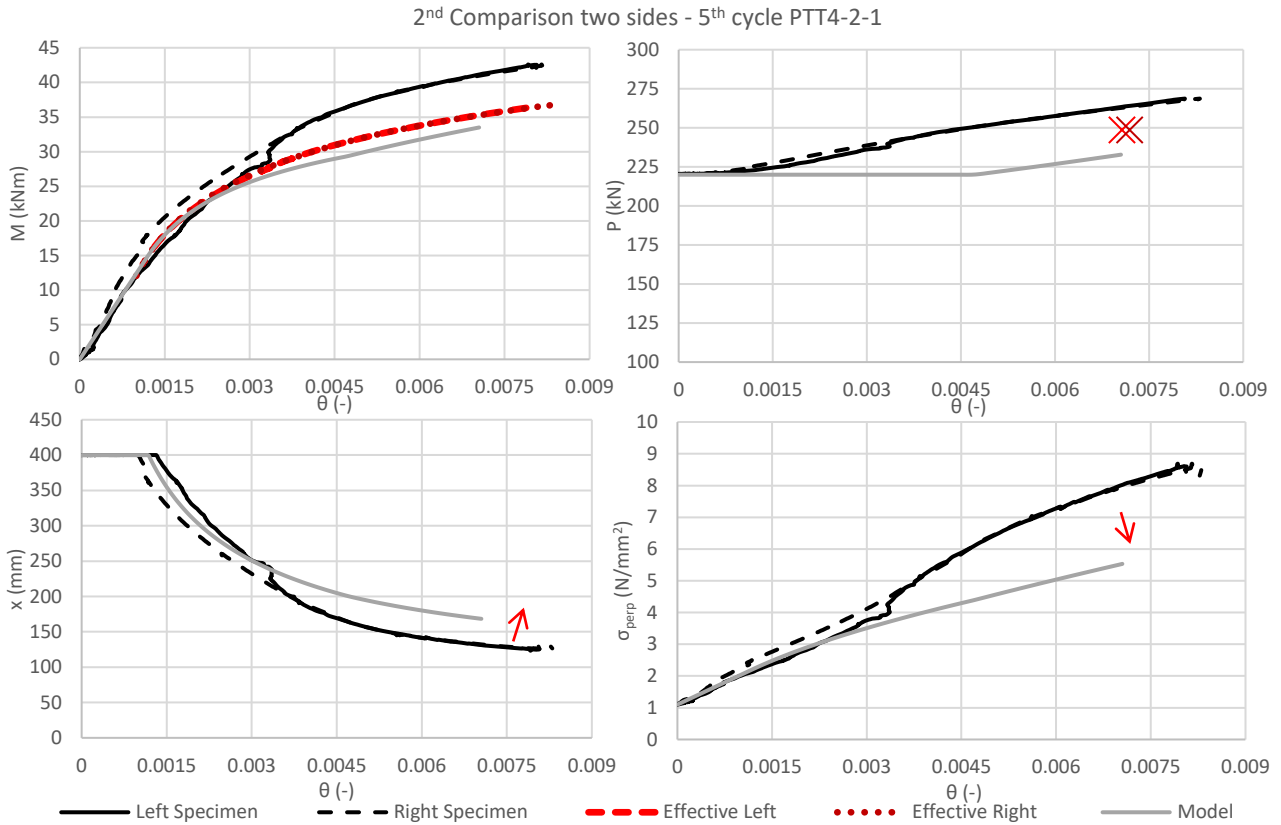

Figure 268 – Evaluation of PTT4-2-1 showing the moment-rotation behaviour, tendon force, stresses at the interface and neutral axis depth proceeding from the left corner in clockwise direction; the neutral axis is calculated with (6.34); the grey curves represent the prediction of the analytical model, while the red curves and crosses indicate the influence of the tendon elongation for the right and left samples

Figure 268 shows the influence of tendon elongation due to the use of the short-threaded rod. The removal of this contribution from the measured values enabled correspondence with the expected values with regard to the determination of the moment-rotation curve. The calculation of the contribution of the elongation on the tendon force (P) at the maximum rotation also resulted in values closer to the expected ones (red cross).

With regard to the neutral axis (x), the values calculated with (6.34) in Figure 268 are more reliable and in agreement with the analytical model until the deviation of the tendon force becomes too significant. A smaller increase in tendon force would decrease the moment capacity (as shown by the left and right effective curves), thus slightly raising the curve representing the depth of the neutral axis (x) and implying lower values of stress perpendicular to the grain (σ_{perp} , arrows in Figure 268) confirmed that no failure occurred after this type of test.

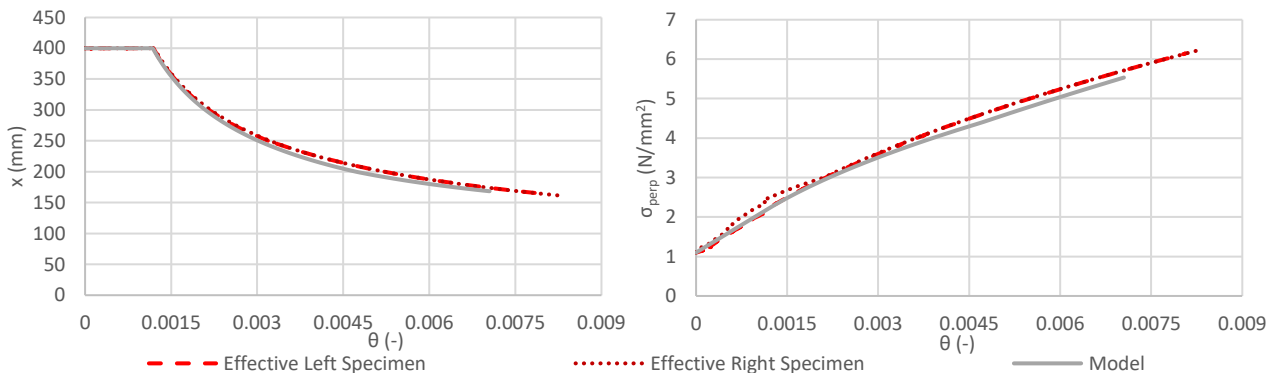

Figure 269 – Neutral axis (x) and stresses perpendicular to grain (σ_{perp}), calculated with (6.34) and considering values of moment and tendon force reduced by the contribution of the excessive tendon elongation

Figure 269 shows x and σ_{perp} calculated using (6.34), (6.35) and (6.36), and considering the effective tendon force as well as moments as reduced by the contribution of the tendon elongation (M and P as shown in Figure 268).

Additional notes on PTT4

In contrast to the LVL-R specimen, the vertical spruce samples repeatedly showed plastic deformation of the surface perpendicular to the grain. This was noticed by observation of the samples after testing, presenting a slight compression of the surface, hardly visible, but tangible. No complete crushing of the grain occurred as for the specimen without steel widening plates. The vertical wall samples were tested repeatedly allowing multiple similar results, confirming the recentring behaviour of the system, the functioning of the steel plates in avoiding unrecoverable crushing of the grain and increasing the stiffness and capacity of the PT-CLT connection.

The slight flattening of the surface of the vertical element was traceable in the moment-rotation curves (Figure 270) and in the amplitude of the raw inclinometer measurements when comparing the first test with the second one, carried out on the same vertical CLT sample (Figure 271).

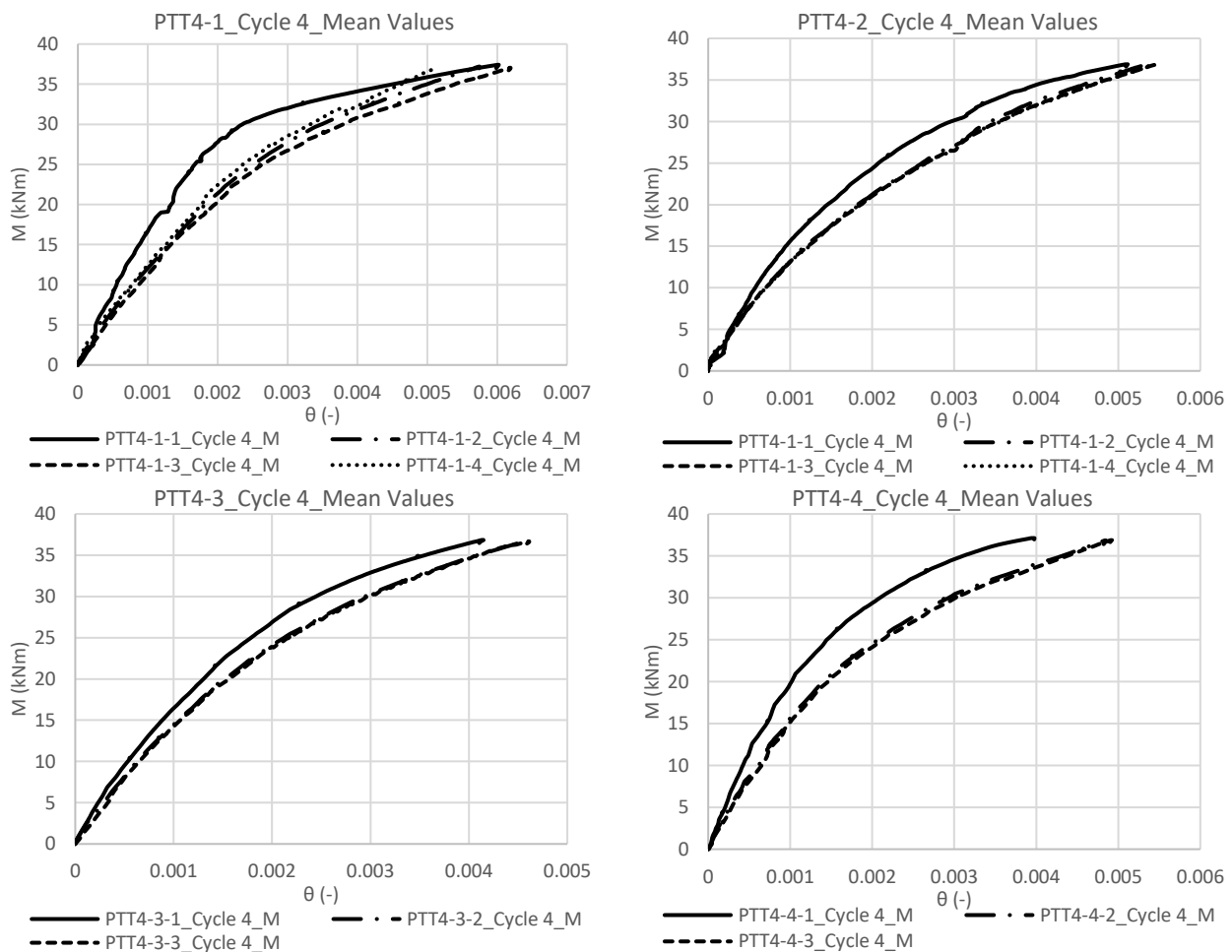

Figure 270 – Graphs of the moment-rotation behaviour for the PTT4 tests showing PTT4-1, PTT4-2, PTT4-4, and PTT4-3 tested samples proceeding from the left corner in clockwise direction; the value of the moment is related to the mean value of the rotations measured at the left and right interfaces with the lateral transducers at the fourth cycle of each test

Figure 270 shows that for all the tested samples the first load cycles (first test) led to a more rigid behaviour, while from the second test onwards the behavioural law of the connection remains unchanged. This confirms that after a first compression occurring at the interface of the connection which implies a plastic deformation,

the subsequent cycles maintain a remarkable stiffness without noteworthy variations, even when considering the fourth test (involving 5 cycles each) of the PTT4-1 or PTT4-2.

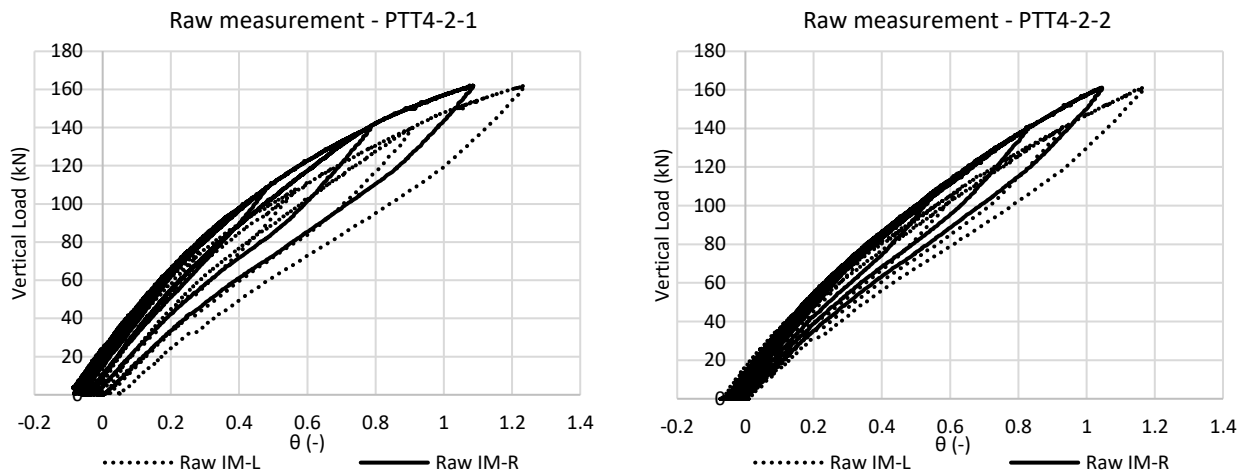

Figure 271 – Graphs representing the direct measurement from inclinometers right (IM-R) and left (IM-L) in relation to the applied vertical loads (effective measurement from external load cell) for the first and second tests on the sample PTT4-2

The same consideration can be seen in Figure 271, where plotting the output of the inclinometers for both tests PTT4-2-1 and PTT4-2-2 reveals that the first test has larger rotation cycles, considering loading and unloading phases.

Finally, Figure 272 shows the top of the PTT4-2 interfaces after all tests have been performed and show no complete or visible crushing of the grain.



Figure 272 – Photos of the wall sample of PTT4-2 after the tests, showing no crushed grain on both the upper left and right sides

6.3.5.4 PTT5-1-1



Figure 273 – Frontal photo showing the setup of the PTT5

Table 196 – Load cycles for the PTT5-1-1 test; the effective vertical loads are reported together with the maximum moment at the interface and the decompression moment measured; moisture content and density values are also reported in relation to the central wall element (CLT)

Cycle	Type	Load (kN)	Eff. Load (kN)	M_{max} (kNm)	M_{dec} (kNm)
0	Prestr.	300	300	-	-
1	Load.	70	73.77	19.55	-
2	Load.	100	107.59	28.51	20.18
3	Load.	130	138.79	36.78	20.23
4	Load.	150	159.92	42.38	20.28
5	Load.	180	192.87	51.11	20.19
6	Load.	200	213.89	56.68	20.24
Moisture content (%)				$\omega = 9.9$	
Density (kg/m³)				$\rho = 647.79$	

Value of the modulus of elasticity perpendicular to the grain (E_{90}) considered to match the analytical model is taken as the mean value obtained from the mechanical tests (Section 6.3.1), implying the following modulus of subgrade reaction (c).

$$E_{90} = 675 \text{ MPa}; \quad c = \frac{E_{90} \cdot 2}{b_c} = 6.75$$

Initial compression

With reference to Section 6.3.4.1, the transducer outputs at the left and right interfaces can be plotted as shown in Figures 274. The average values of these outputs (T-LM and T-RM) can be plotted along with the mean deformation of both samples as a visual representation of the Δc (T-M in Figure 274c).

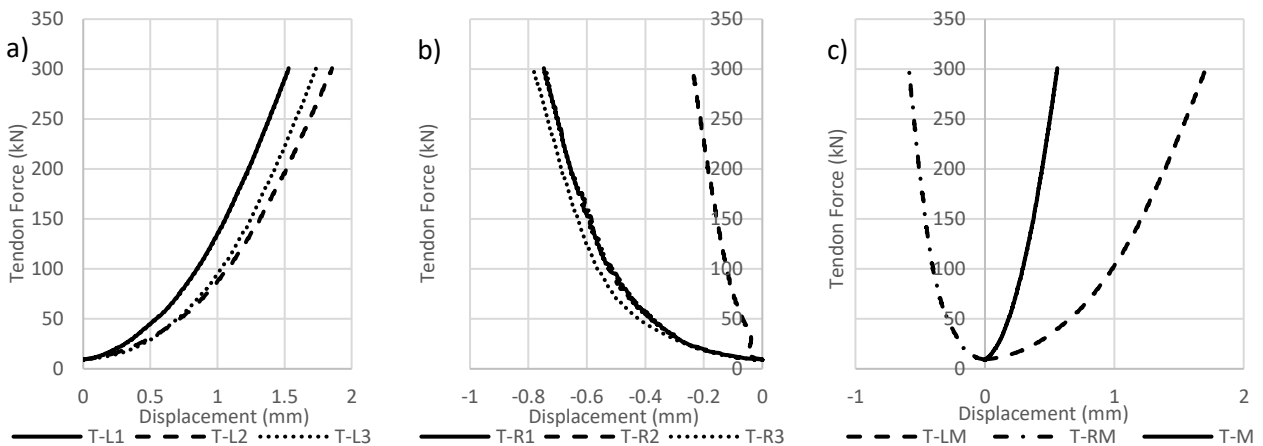

Figure 274 – a) output of the transducers on the left side of the vertical element for PTT5-1-1; T-L1, T-L2 and T-L3 represent the three transducers placed from top to bottom respectively; b) output of the transducers on the right side of the vertical element for PTT5-1-1; c) mean value of the transducer outputs of the left (T-LM) and right (T-RM) sides, together with their average (T-M), coinciding with Δc for the vertical element of PTT5-1-1

With (6.49) the mean deformation at the single interface is then evaluated and compared with the value obtained, using the simplified spring model (6.50) [169].

$$w_{mean} = \frac{\Delta c}{2} = 0.28 \text{ mm} \quad (6.49)$$

$$\Delta l = \frac{N \cdot l}{E \cdot A} = \frac{P_0}{A_b \cdot E_{90}} \cdot \frac{b_c}{2} = \frac{300 \cdot 000}{200 \cdot 000 \cdot 675} \cdot \frac{200}{2} = 0.22 \text{ mm} \quad (6.50)$$

The measured value is slightly higher than the one calculated with the simplified spring model. However, more accurate results were recorded for the second (PTT5-1-2) and third test (PTT5-1-3) on the same sample, with prestressing deformation of 0.22 and 0.23, respectively. Similarly for the second and the third samples, the first application of the prestressing force resulted in a higher deformation due to a non-perfectly uniform surface of application of the compressive loads. The LVL-R samples were, in fact, composed by seven LVL-R boards glued in the laboratory for this purpose and showed slight irregularities near the glue lines.

Due to the rigid displacement of the entire specimen during the prestressing phase, it was only possible to extrapolate an average value from the transducer results without having the possibility of characterising the contribution of the individual sides of the specimen.

Rotation at the interface

The rotation values obtained from the measurement are compared with each other, using the three methods exposed in Section 6.3.4.2 (Figure 275).

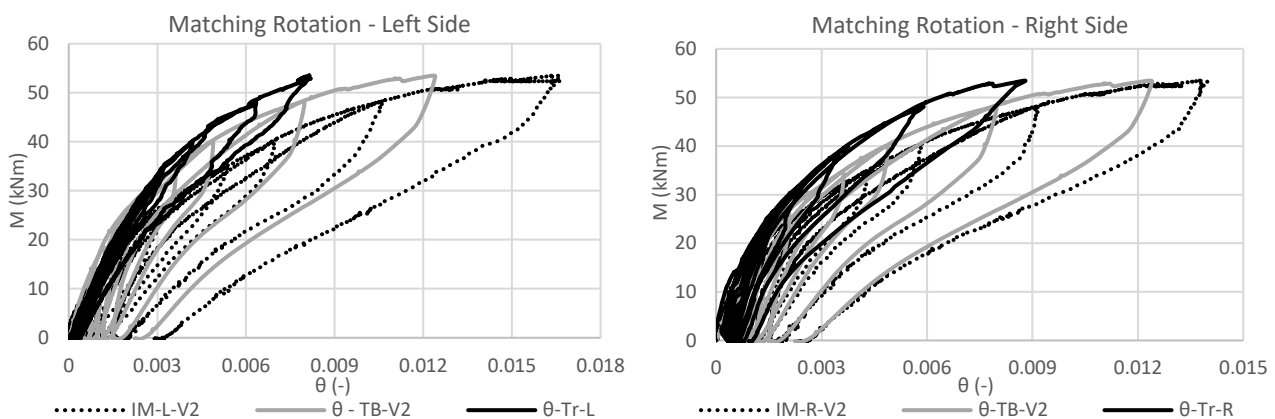

Figure 275 – PTT5-1-1 moment-rotation curves for the left and right sides; comparison is made for the values obtained from the lateral transducers (θ -Tr), the lower transducer (θ -TB), and the inclinometers (IM)

The rotation calculated with the output of the inclinometers (IM-V2) resulted larger for the left horizontal piece than for the right one. Considering the rigid displacement of the specimen in one direction (to the right when looking at the initial compression plots in Figure 274), it is likely that the left horizontal piece had a larger span than the right piece and was found to have greater rotations. The rotation measured by the lateral transducers (θ -Tr), on the other hand, was aligned at both interfaces and matched the single rotation calculated from the measured vertical displacement (θ -TB) for the first elastic part of the rotation, only to be slightly lower on both sides of the specimen at later stages, certainly due to the rotation of the horizontal CLT pieces within the steel angle profiles.

This behaviour was recurrent during all tests with the steel widening plates, sometimes more noticeable.

Cycle 6

The sixth cycle was isolated in the loading phase, and the evaluations introduced in Section 6.3.4.3 led to the determination of the moment, tendon force, neutral axis, and stress perpendicular to the grain in relation to the rotation obtained from the lateral transducers (θ -Tr). In all graphs shown, the results of the analytical model are plotted together with the output of the left and right sides.

While Figure 276 shows the results considering the neutral axis (x), calculated by the lateral transducers (6.33), Figure 277 gives the results obtained, using (6.34) with the measured values of moment and tendon force. Figure 277 also shows the influence of tendon elongation for the phase after decompression.

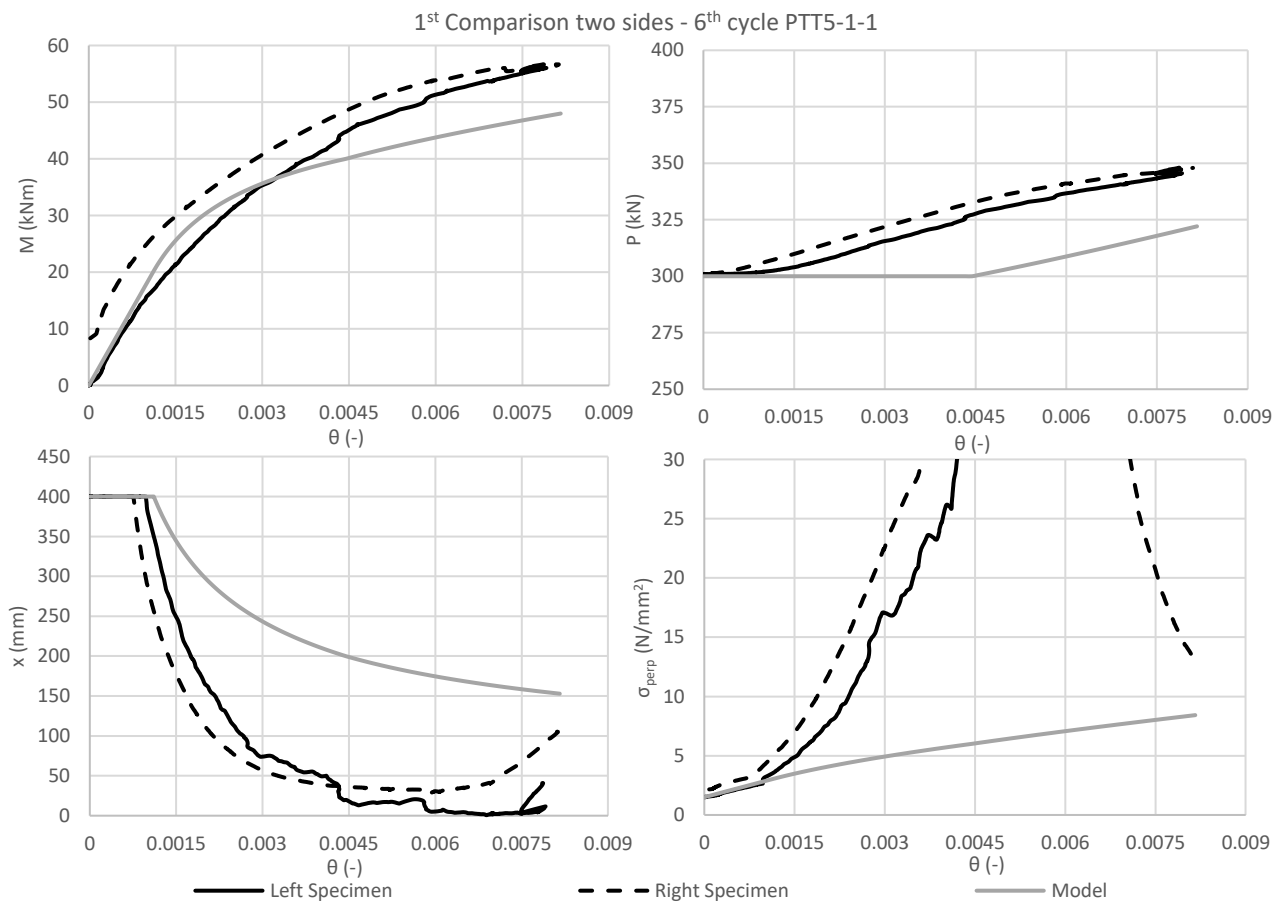

Figure 276 – Evaluation of PTT5-1-1 showing the moment-rotation behaviour, tendon force, stresses at the interface and neutral axis depth proceeding from the left corner in clockwise direction; the neutral axis is calculated with (6.33); the grey curves represent the prediction of the analytical model

The moment-rotation behaviour is well predicted until the influence of the tendon force increase becomes too significant and leads to an underestimation of the connection capacity. This contribution has been considered in Figure 277.

The neutral axis (x) calculated with the lateral transducer displacements (Figure 276), although close to the determination of the rotation corresponding to decompression (M_{dec}), does not provide accurate results as the rotation values increase. This is confirmed by receiving unrealistic values of the stresses perpendicular to the grain (σ_{perp}), which would have led to visible crushing on the wall samples.

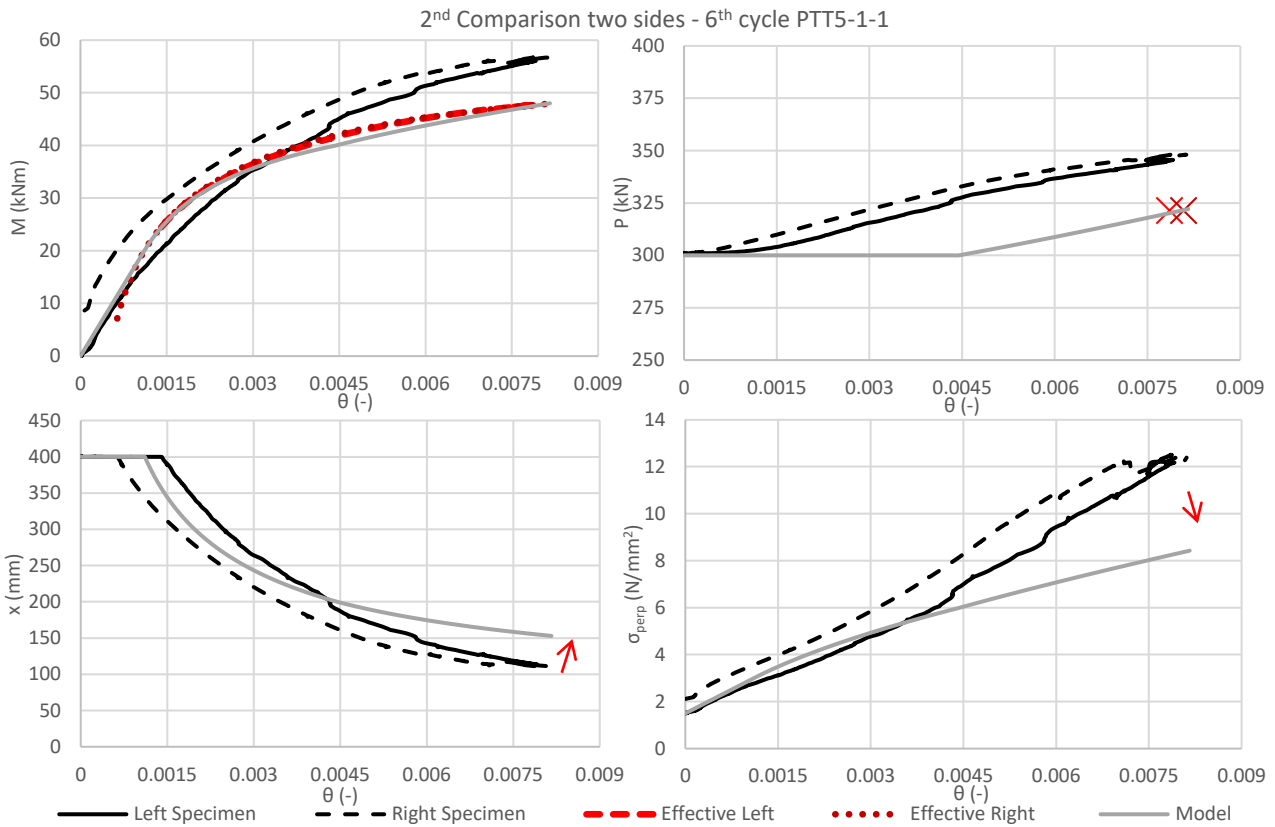

Figure 277 – Evaluation of PTT5-1-1 showing the moment-rotation behaviour, tendon force, stresses at the interface and neutral axis depth proceeding from the left corner in clockwise direction; the neutral axis is calculated with (6.34); the grey curves represent the prediction of the analytical model, while the red curves and crosses indicate the influence of the tendon elongation for the right and left samples

Figure 277 shows the influence of tendon elongation due to the use of the short-threaded rod. The removal of this contribution from the measured values enabled correspondence with the expected values, with regard to the determination of the moment-rotation curve. The calculation of the contribution of the elongation on the tendon force (P) at the maximum rotation also resulted in values closer to the expected ones (red cross).

With regard to the neutral axis (x), the values calculated with (6.34) in Figure 277 are more reliable and consistent with the analytical model until the deviation of the tendon force becomes too significant. A smaller increase in tendon force would decrease the moment capacity (as shown by the left and right effective curves), thus slightly raising the curve representing the depth of the neutral axis (x) and implying lower values of stress perpendicular to the grain (σ_{perp} , arrows in Figure 277), confirming that no failure occurred after this type of test.

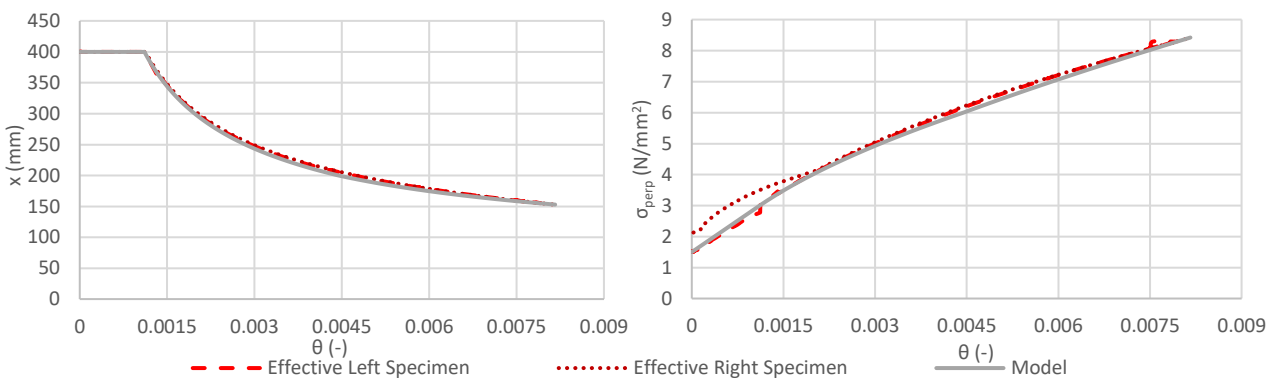

Figure 278 – Neutral axis (x) and stresses perpendicular to grain (σ_{perp}), calculated with (6.34) and considering values of moment and tendon force reduced by the contribution of the excessive tendon elongation

Figure 278 shows x and σ_{perp} calculated, using (6.34), (6.35) and (6.36), and considering the effective tendon force and moments as reduced by the contribution of the tendon elongation (M and P as shown in Figure 277).

Additional notes on PTT5

No minimal plastic deformation occurred in all the specimens (PTT5-1, PTT5-2, and PTT5-3). Therefore, in contrast with the results of the specimens with vertical CLT elements, the LVL-R specimens providing steel widening plates were characterised by identical behaviour for all tests carried out on the same specimen. This results in identical behaviour between the three tests performed on the same samples, without loss of stiffness and residual deformation (Figure 279).

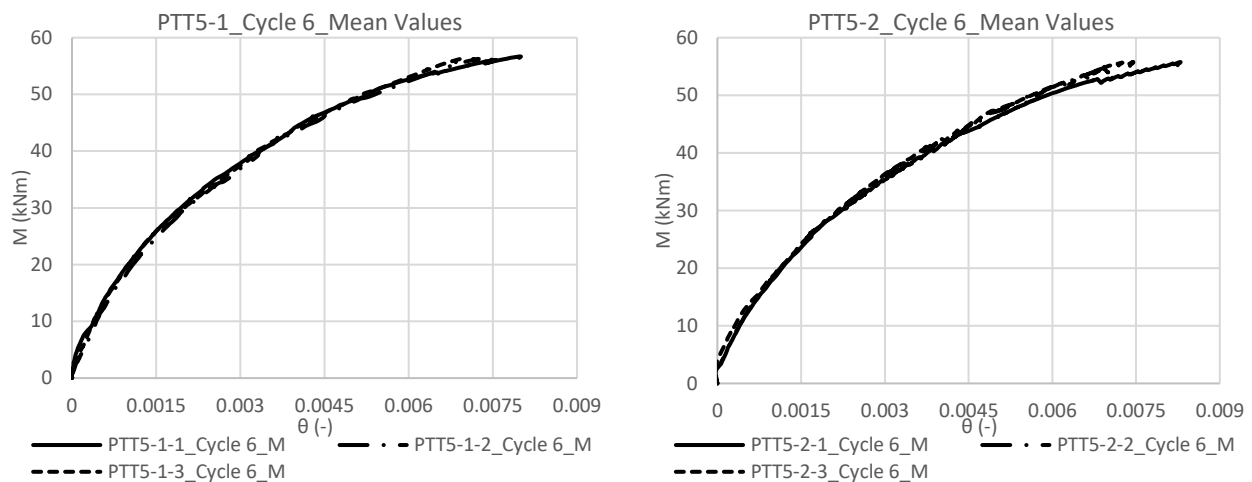

Figure 279 – Graphs of the moment-rotation behaviour for the PTT5 tests showing PTT5-1 and PTT5-2 tested samples; the value of the moment is related to the mean value of the rotations measured at the left and right interfaces with the lateral transducers at the sixth cycle of each test

Finally, Figure 280 shows the top of the PTT5-1 interfaces after all tests have been performed and show no visible or tangible deformation perpendicular to the grain.



Figure 280 – Photos of the wall sample of PTT5-1 after the tests, showing no crushed grain on both the upper left and right sides

The beech LVL (Baubuche) has been shown to withstand compression perpendicular to the grain affecting the edge of the steel angle plates during rotation. Figure 281 shows the rotation of the right sample of PTT5-3-3 during the final cycle. As a final scheduled test, an additional cycle (7°) was included in the protocol to reach a vertical load of 250 kN (effective 258.66 kN) and resulting in a moment at the interfaces of 68.55 kNm. Although the threaded rod deformed critically and plastically, compromising its function, the LVL beech

reinforcement of the outer layers of the horizontal elements did not present any damage or residual compression, proving to be effective in protecting the outer surfaces from plastic and irreversible crushing.



Figure 281 – Rotation of the right horizontal sample during the final cycle of PTT5-3-3, showing the elastic deformation of the horizontal element inside the composed steel plates and the effectiveness of the LVL beech layers in protecting the surface of the horizontal elements during rotation

Figure 281 also shows that the CLT transverse layers in the horizontal elements were, in cases of higher loads, encountering cracks as first evidence of rolling shear in the CLT elements (Figure 282a) or local weaknesses in correspondence of the bonded LVL elements (Figure 282b). However, failures of the transverse layers and of the entire horizontal element never occurred during the entire experimental campaign.

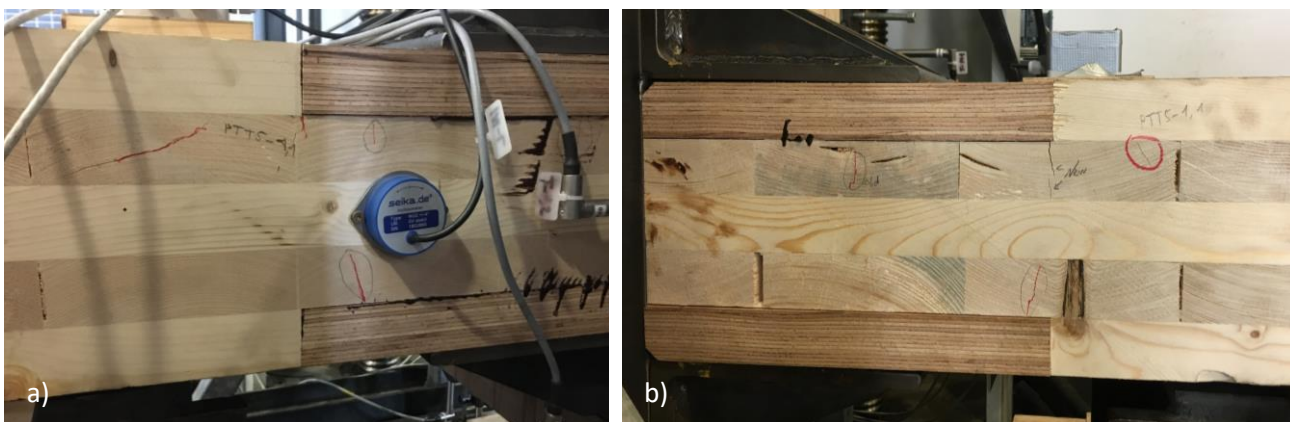

Figure 282 – a) and b) cracks occurred during the rotation phases due to rolling shear and local stresses, concentrated in proximity of the junction between LVL and CLT

6.4 Final considerations

Finally, a series of comparisons were made, using the results of all the tested specimens with respect to moment-rotation behaviour, initial stiffness, and failure considerations as the most relevant information to be considered for a structural application.

In order to characterise the comparison, Table 197 shows the density and moisture content values of all the vertical elements tested (except for PTT4-1, initially considered for the calibration tests and then included in the evaluations).

Table 197 – Results of the physical tests for the CLT and LVL-R wall samples

CLT samples	ρ (kg/m ³)	ω (%)	LVL-R samples	ρ (kg/m ³)	ω (%)
PTT2-1	436.03	10.7	PTT3-1	653.98	10.0
PTT2-2	431.35	10.9	PTT3-2	663.59	10.2
PTT2-3	421.66	10.8	PTT3-3	656.44	10.0
PTT4-2	422.25	10.9	PTT5-1	647.79	9.9
PTT4-3	420.21	11.4	PTT5-2	643.95	9.9
PTT4-4	455.00	10.6	PTT5-3	643.66	10.2

The moisture content ω was measured within the expected ranges of 12±2% for the CLT samples and 9±2% for the LVL samples.

6.4.1 Comparisons

6.4.1.1 Between cycles

The moment-rotation curves were compared for each cycle of the tests performed in order to evaluate the behaviour of the post-tensioned connection when subjected to several load cycles.

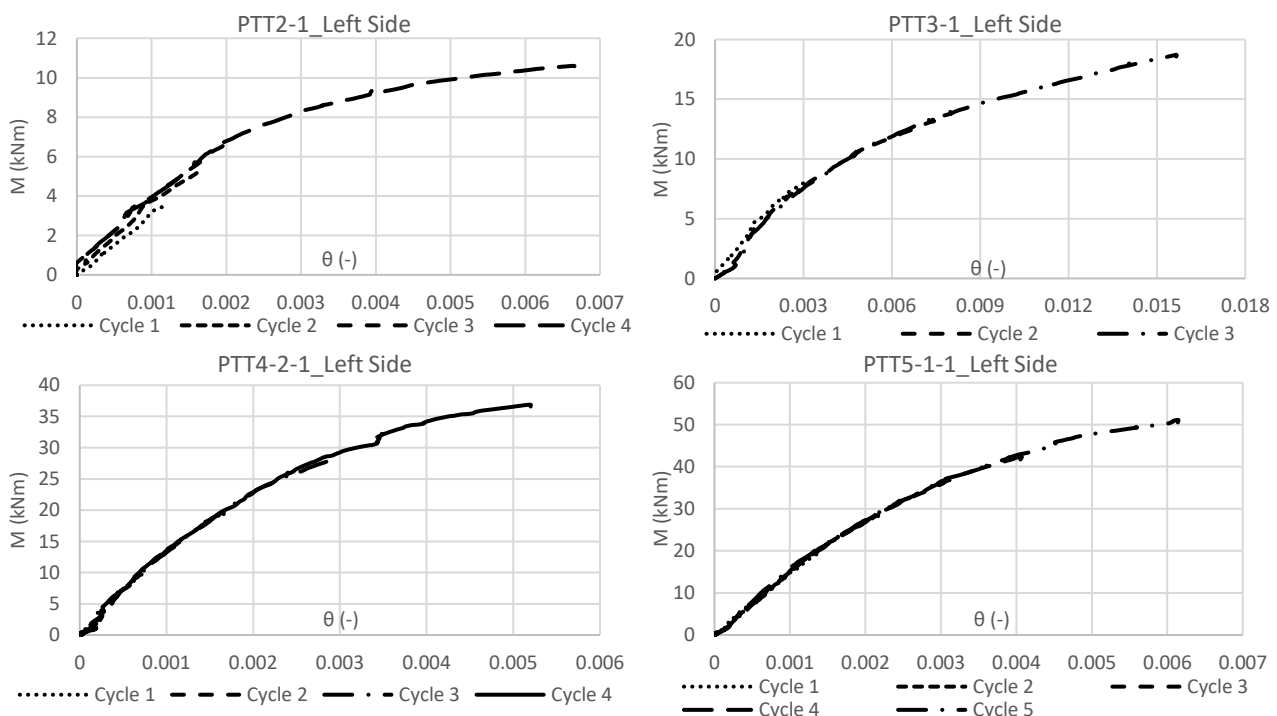

Figure 283 – Moment-rotation of the different overlapping cycles considering the left interface for a test of each type

Figure 283 shows an example for each test type carried out in the experimental campaign. For each test the load cycles in terms of moment-rotation behaviour affecting the left interface have been superimposed to verify the behaviour of the connection under cyclic loading.

The result is a correspondence of the behaviour under all cycles for each test type, confirming the ability of the PT-connections to guarantee a constant and consolidated moment-resisting behaviour with re-centring capabilities.

6.4.1.2 Between left and right horizontal elements

The moment-rotation behaviour of the left and right specimens was always compared for the most representative cycle in order to prove the consistency of the results on the different interfaces. Figure 284 shows the results where the deviation between the moment-rotation curves of the left and right interfaces is the greatest.

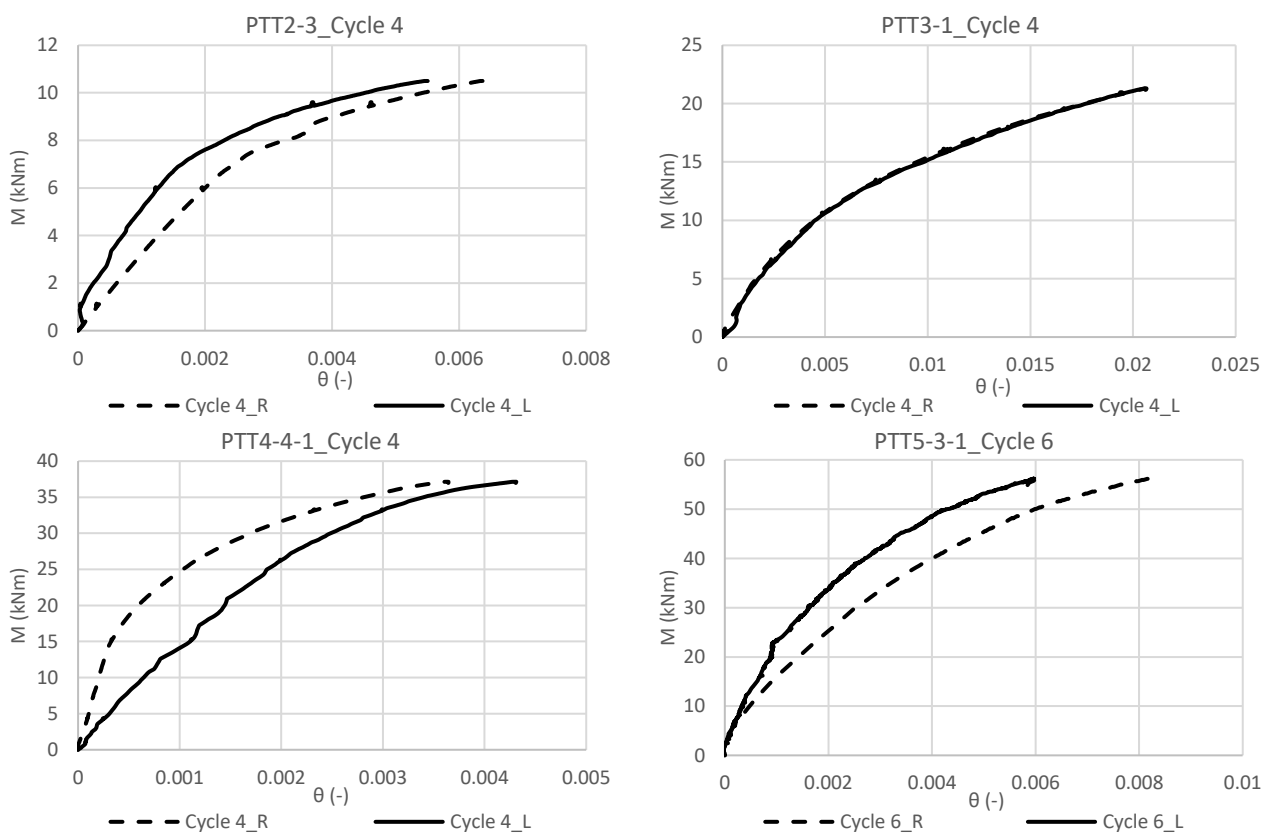

Figure 284 – Comparisons of moment-rotation behaviour recorded on the same cycle from the left and right interfaces; comparisons presenting the greatest deviation are shown for each test type (from PTT2 to PTT5)

Figure 284 shows that the tests involving CLT samples as vertical wall elements were also affected by a greater deviation between the results of the two interfaces, confirming a greater variability in the material performance than the LVL-R samples. Furthermore, the presence of the steel widening plates is also reason for deviation between the two sides of the experiments.

The deviations could be due to the rigid displacement of the specimen within the test supports or because of irregularities affecting the steel widening plates. As mentioned in previous sections and shown in Figure 281, one of the two steel widening plates was affected by deformations of the angle profiles, implying different responses from the left and right samples.

However, the deviation that occurred for these examples (Figure 284) is the maximum recorded for all the samples tested, indicating a consistent result between the different sides of the same specimens. In

order to compare the different tests together (Section 6.4.1.3) the mean values of the rotation between the left and right recordings were found and related to the recorded moment.

6.4.1.3 Between test typologies

The most representative cycles, not affected by plastic deformation of the grain (PTT2) and more suitable for comparison between specimens, are compared by considering the average values of rotation between the left and right interfaces and the moment recorded for the different types of test.

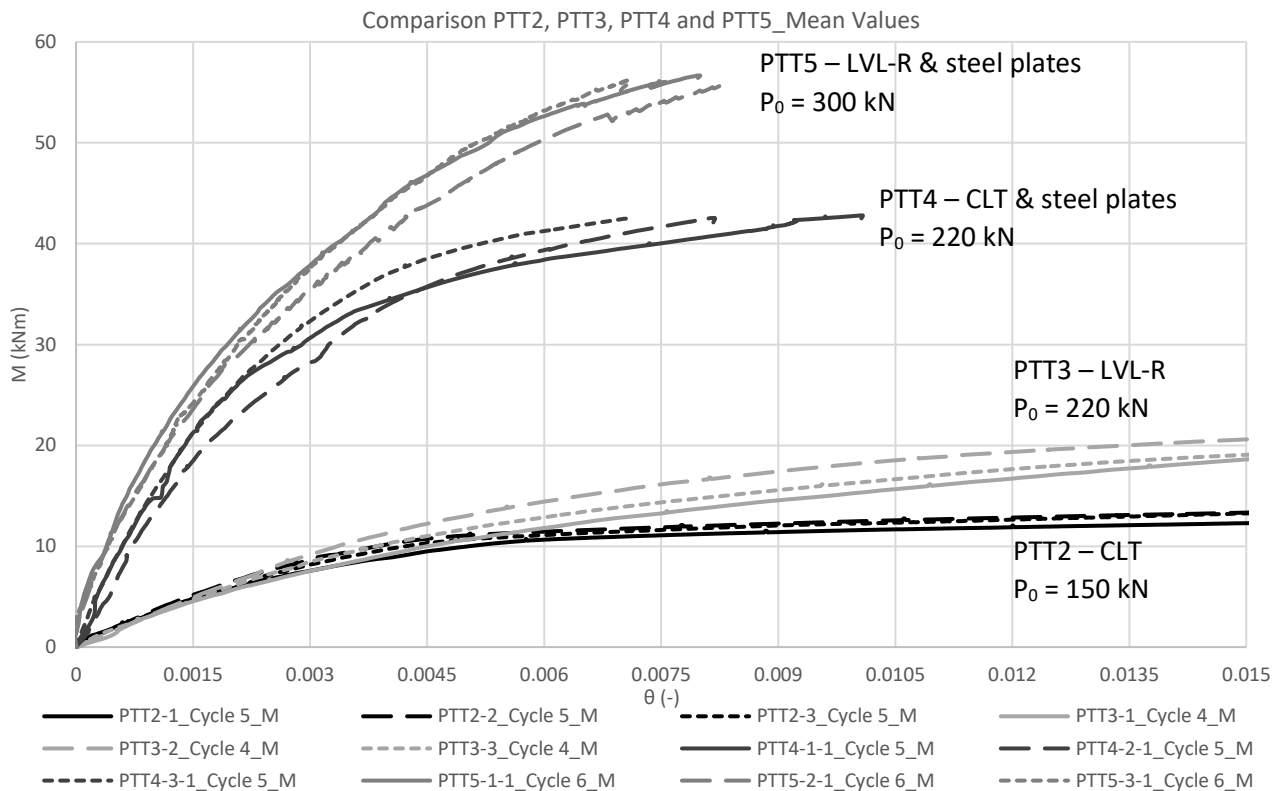

Figure 285 – Average moment-rotation behaviour (mean rotation value considering left and right interfaces) of all the specimens considering the last and most loaded cycle

Figure 285 shows the last cycle of all the samples tested together. The variables that determine the different results are as follows:

- initial tendon force (P_0) – as reported in [164, 169, 210], the initial tendon force determines the moment capacity of the connection; with reference to (6.21), the greater the tendon force, the greater the maximum moment of the connection. This is evident in Figure 285, which compares the results of PTT2 with PTT3 (Figure 286a) and PTT4 with PTT5 (Figure 286b);
- composed steel plates – the presence of the widening plates allows a greater height to be considered for the horizontal members leading to a substantial increase in the stiffness and capacity of the connection, as shown in Figure 287 which compares the behaviour of the connection with and without steel widening plates (different tendon forces are also assigned);
- material of the vertical specimens – the mechanical characteristics of the vertical element should determine the initial stiffness of the PT-connection; in particular the value of E_{90} determines the subgrade reaction modulus, which characterises the simplified spring model used for the determination of the behaviour and was of minor relevance to distinguish the results between CLT and LVL-R elements; indicating a behaviour, especially for the CLT elements, stiffer than expected in the initial loading phase. This is evident in Figures 285 and 286, as well as in the results of the mechanical tests (Figure 233), where the use of LVL-R samples as vertical walls implied only a slight

increase in initial stiffness for the cases with steel widening plates (Figure 286b) and equal results for the cases without steel plates (Figure 286a).

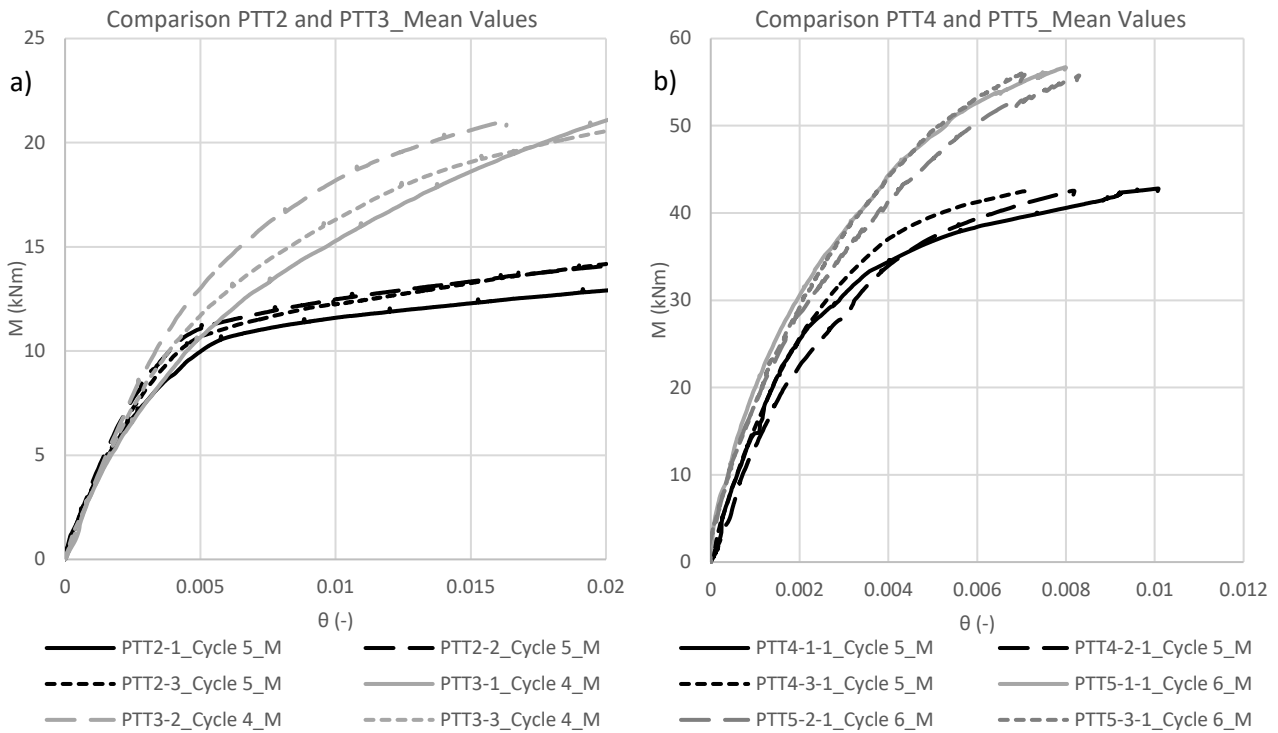

Figure 286 – Average moment-rotation behaviour (mean rotation value considering left and right interfaces) of the tested specimens considering the last and most loaded cycle: a) comparison between specimens PTT2 and PTT3; b) comparison between specimens PTT4 and PTT5

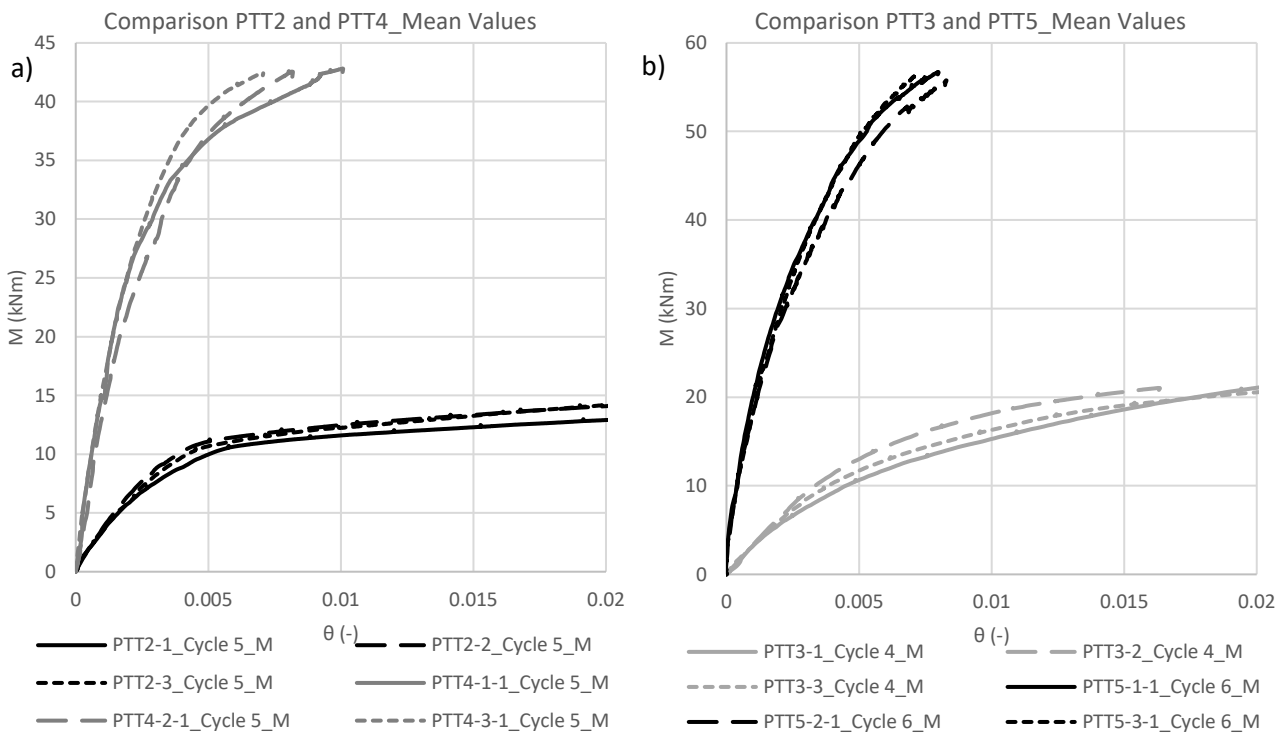

Figure 287 – Average moment-rotation behaviour (mean rotation value considering left and right interfaces) of the tested specimens considering the last and most loaded cycle: a) comparison between specimens PTT2 and PTT4; b) comparison between specimens PTT3 and PTT5

Although the initial stiffness is comparable, it is assured that the use of LVL-R contributed positively to the compression strength perpendicular to the grain, presenting no failures with or without the steel plates and ensuring repeatable behaviour during multiple cycles.

6.4.1.4 Regarding the initial stiffness

The initial stiffness K_I is defined with reference to [169] as the stiffness up to the moment when decompression begins, and can be calculated with a secant between a moment of 1 kNm and the moment of decompression for all the load cycles in which the moment of decompression has reached (6.51) [169]. For the other cases (mostly the first cycles) the maximum moment recorded was used for the calculation.

$$K_I = \frac{M_{dec} - 1 \text{ kNm}}{\theta_{M_{dec}} - \theta_{M=1 \text{ kNm}}} \quad (6.51)$$

Table 198 – Initial stiffness for PTT2 test specimens, the decompression moment (or maximum moment for the first cycles) is reported together with the initial stiffness calculated for both left and right specimens; mean values considering the left and right specimen are then calculated for each cycle and finally for the whole specimen

Cycle	PTT2-1				PTT2-2				PTT2-3			
	M_{dec} kNm	$K_{I,left}$	$K_{I,right}$ kNm/rad	$K_{I,mean}$	M_{dec} kNm	$K_{I,l}$	$K_{I,r}$ kNm/rad	$K_{I,m}$	M_{dec} kNm	$K_{I,l}$	$K_{I,r}$ kNm/rad	$K_{I,m}$
1	3.4	3029.7	2793.5	2911.6	4.2	3942.8	2887.7	3415.2	3.6	4851.1	2604.9	3728.0
2	5.0	3058.2	3101.5	3079.8	5.0	4338.1	3071.7	3704.9	5.0	4688.3	2846.9	3767.6
3	5.0	3149.7	3191.0	3170.3	5.0	4319.3	3188.8	3754.0	5.0	4666.9	3013.9	3840.4
4	5.0	3146.0	3185.3	3165.6	5.0	4267.8	3191.3	3729.6	5.0	4317.9	3029.0	3673.4
5	5.0	2733.8	2838.3	2786.1	5.1	3904.8	2889.1	3396.9	5.0	3457.6	2702.6	3080.1
Mean	-	-	-	3022.7	-	-	-	3600.1	-	-	-	3617.9

Table 199 – Initial stiffness for PTT3 test specimens, the decompression moment (or maximum moment for the first cycles) is reported together with the initial stiffness calculated for both left and right specimens; mean values considering left and right specimen are then calculated for each cycle and finally for the whole specimen

Cycle	PTT3-1				PTT3-2				PTT3-3			
	M_{dec} kNm	$K_{I,left}$	$K_{I,right}$ kNm/rad	$K_{I,mean}$	M_{dec} kNm	$K_{I,l}$	$K_{I,r}$ kNm/rad	$K_{I,m}$	M_{dec} kNm	$K_{I,l}$	$K_{I,r}$ kNm/rad	$K_{I,m}$
1	7.4	2667.1	2333.2	2500.2	7.3	3234.7	2818.6	3026.6	7.3	2617.1	2481.7	2549.4
2	7.3	2812.3	2555.5	2683.9	7.4	3439.2	3533.2	3486.2	7.3	2890.7	2854.3	2872.5
3	7.4	2831.6	2688.0	2759.8	7.3	3381.6	3841.3	3611.4	7.4	2853.2	2901.6	2877.4
4	7.4	2654.1	2455.3	2554.7	7.4	3155.3	3074.5	3114.9	7.4	2842.6	2703.4	2773.0
5	-	-	-	-	-	-	-	-	7.4	2598.6	2398.3	2498.4
Mean	-	-	-	2624.6	-	-	-	3309.8	-	-	-	2714.1

Tables 198 and 199 show the initial stiffness for the specimens without the steel widening plates. As mentioned in the previous sections and visible in Figure 286, the influence of the material on the initial stiffness in the experimental investigation carried out is not evident, and the use of CLT elements instead of LVL-R did not lead to a reduction in stiffness, but to equal or even higher values. A possible explanation could be the low prestressing force applied to the specimens with a consequent stiffness value dependent on the initial part of the material behavioural law.

On the other hand, these initial stiffness values together with the graphs in Figure 286 confirm that the prestressing force applied to the specimens is not decisive for the results obtained. The PTT2 specimens provide, in fact, an initial prestressing force of about 150 kN against the 220 kN for the PTT3 specimens. As indicated in [169], the spring constant is a function of the moment of inertia of the horizontal element and

adopted in comparison with previous studies [169]. The iterative procedure provided by the analytical method for the third phase could be anticipated for the phases following decompression (second phase) by progressively increasing the tendon force and the resulting equilibrium moment in relation to a measured vertical displacement that enhances a rigid rotation of the horizontal element at the interface and the resulting tendon elongation.

In conclusion, the analytical model is shown to be able to predict the behaviour of the PT-CLT connection and to allow the implementation of the moment-rotation behaviour in FEM model. Thus, resulting in a conservative response in terms of moment capacity and initial stiffness, when considering the mean moduli provided by the manufacturers and lower values of tendon forces. The use of strands and higher values of tendon forces, as foreseen by the main design solution, guarantees the accuracy of the analytical model especially regarding to the first linear phase of the moment-rotation behaviour which is the most relevant part for the seismic analysis, as shown in Section 5.3.3.

The use of reinforcing layers such as beech LVL (Figure 281), or the use of LVL-R specimens (corresponding to any vertical element providing a higher value of compressive strength perpendicular to the grain) has been shown to be effective in avoiding the crushing of the grain and maintain a constant response of the PT-CLT connection during multiple cycles. It is the author's opinion that considering only a stiffer outer layer, e. g. made of hardwood, applied to a spruce CLT wall would be a good and resilience solution, without considering whole CLT hardwood elements (less common, more expensive, and still under investigation). It was, in fact, evident that the stiffness of the connection is strongly dependent on the geometry of the horizontal elements considering the widening plates, more than on the modulus of subgrade reaction. For the main project solution (Section 5.3.3), a steel widening plate with a height of 600 mm was proposed in order to guarantee sufficient stiffness to the whole structure (the widening plates foreseen for the tests had plates with a height of 400 mm), although the capacity and the stresses perpendicular to the grain were too conservative.

In order to optimise the production and effectiveness of wood elements, horizontal elements, as well as vertical elements (when a complete hardwood CLT element is avoidable), could be characterised by an outer hardwood layer in the production stages, as it is already an established strategy of manufacturers to change the outer layers of CLT products to improve structural performance or aesthetics.

Finally, further tests should be foreseen to verify the behaviour under horizontal loads and thus considering the shear deformation that could strongly influence the stiffness and the capacity of the PT-CLT connection, as shown for previous considerations involving the adaptation of the analytical model (Section 5.3.3).

7. Synergic integration of the technologies

As already mentioned in the previous chapters, the strengthening structure was always developed in direct connection with the architectural technology of the units of extension. The research work was not only aiming at the evaluation of the seismic improvement, but also at the direct integration and design of the prefabricated components that constitute the new envelope of the existing building and the new housing units for the inhabitants.

This section describes the technological solutions developed for the steel and timber exoskeletons, introducing the retrofitted conductivity values after renovation and the assembly procedures towards the finalisation of the design solutions. Additional integrated aspects of the projects, such as the HVAC system and the adopted RES were indirectly considered during the design process, but not investigated in depth by the author, as they are outside his competence.

7.1 The Athens definitive design – on the steel exoskeleton

The main technological solution was designed on the Athens case study due to the future implementation on the prototype. The principal efforts of the whole Pro-GET-onE consortium were therefore to develop and characterise this application, while at the same time aiming at generalised technological solutions that could have been translated to different realities/case studies in larger stages.

The work presented in this section is therefore strongly dependent on the input of the Pro-GET-onE consortium and represents the design solution developed up to the involvement of the construction company, the suppliers and the professional studio that subsequently developed the executive design of the prototype (currently under construction). In particular, the distribution of the units, the technical installations, and the dialogue with the existing building were developed by the whole consortium, based on the specific experience of its members. Concerning the technological details, while sun-space and extra-room solutions were mainly developed by the researchers of the Technical University of Munich (TUM), the balcony alternatives, as well as the development of the architectural drawings (Appendix C) with their detailed solutions, were mainly developed by the author under the supervision of TUM (WP leader).

7.1.1 Overview of the renovation project

The building introduced in Section 5.1 has never been renovated since its construction and has accumulated several criticalities during its lifetime [142].

- The envelope is totally lacking in thermal insulation on all surfaces in contact with unheated areas or the outside and presents visible problems of rising damp (Figure 288). The single glazed windows and doors have no thermal break and therefore need to be replaced.
- The building has an obsolete system complex as it has central heating with radiators, hot water is produced by a boiler and an oil burner located in the basement of the building. There is no mechanical ventilation, only natural ventilation through openings. This, together with the poor insulation conditions mentioned above and the fact that there is no use of renewable energy sources, makes it necessary to completely redo the internal pipes distribution.
- The student rooms of only 9 m² are considered unsuitable to accommodate students by today's standard. The rooms are only equipped internally with a shower that is separated from the rest of the room by a light panel which creates problems of water leakage, risking not only the integrity of the structure but also the safety of the users (Figure 288). The toilets are in common use for each floor, causing discomfort to users, not being a standard compatible with today's living habits. In

addition, there is no air conditioning, making it very uncomfortable during the hottest months of the year.

These issues led to the identification of the main needs to be met in the renovation project as follows [142]:

- additional space: through a redistribution of the internal spaces, already determined by an architectural project commissioned and provided by the National and Kapodistrian University of Athens (NKUA), and the addition of the new housing units foreseen by the extension through the exoskeleton (focus of this section);
- thermal comfort: through an adequate HVAC system that includes the renovation of the systems both inside and outside the building envelope (aspect not covered by this research);
- safety: through an adequate strengthening structure to improve the seismic performance of the existing building (section 5.1).



Figure 288 – Photos of the Athens case study showing the current situation of degradation and lack of space

The existing internal distribution shown in Figure 289a is planned to be renewed independently of the application of the Pro-GET-onE strategy by providing a new distribution that reduces the common space of the corridors and allocates more space (including private toilets in every room). At the same time, some of the rooms have been designated to become double rooms in order to better exploit the application of Pro-GET-onE, with its additional space, new integrated technical systems (ELFOPack) and allowing better monitoring of impacts after the renovation (Figure 289b).

The design provides extensions for each room by combining the exoskeleton structure with the existing one, creating new spaces with different uses (Figure 290). The extension will have a depth of approximately 2 m (considering the overhang on the steel frame span of 1.5 m) and is divided into three main uses: balcony, sun-space, and extra-room. The technological components that create these units represent the main challenge for the architectural design and are described in the next sections.

The arrangement of the new units on the façade has been kept variable but reduced to a minimum in order to reduce the total cost of the renovation. As an initial configuration, sun-spaces and extra-rooms were provided in the first span in correspondence of the double rooms (north side), while balconies were assigned to all the other extensions around the building.



Figure 289 – a) Existing internal distribution with related use; b) new internal distribution provided by the renovation project independently commissioned from the NKUA and constituting the base for the application of the Pro-GET-one strategy – Source: [142]

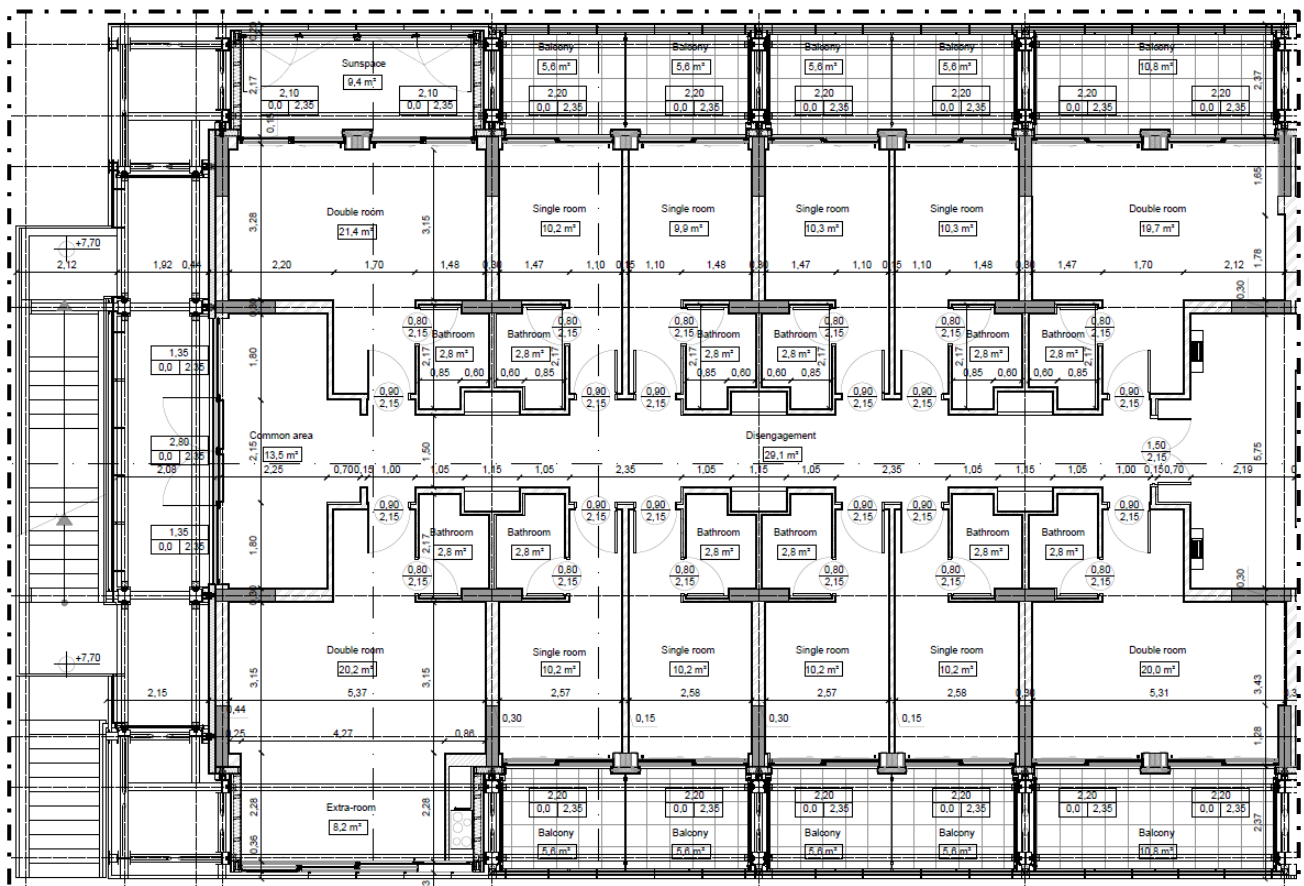

Figure 290 – Technical drawing of the plan of the third floor of the north part of the Athens student house, showing the architectural extensions of the existing rooms

A decisive concept in the development of pre-assembled architectural solutions was the need to maintain the possibility for the owners of the units to change (improve) the solution adopted. Theoretically, in fact, the exoskeleton could be applied as a base and, depending on the economic feasibility of the users, the most suitable solution could be provided, with increasing intervention costs, linked to the single unit, according to the choice of no volumetric increase (steel skeleton), balcony, sun-space and extra-room.

In order to present the project and with a view to obtaining building permits for the construction of the prototype, the author developed a series of technical drawings based on the technological solutions developed within the Pro-GET-onE consortium.

- Layouts 1 to 6 – Architectonic plans of the various floors of the project state: they represent the planimetric development, with notations, areas, and dimensions after the application of the Pro-GET-onE steel-based solution (e.g., Figure 291b).
- Layouts 7 to 9 – Architectonic elevations of the project state: they represent the façades after the application of the Pro-GET-onE steel-based solution (e.g., Figure 291a).
- Layouts 10 and 11 – Vertical cross-sections of the project state: they represent the vertical cross-sections of the Pro-GET-onE steel-based solution.
- Layouts 12 to 15 – Technical details of the balcony solutions: they represent the horizontal and vertical cross-sections of the different technological solutions for the construction of the balcony slabs using composite steel/RC, aluminium and CLT respectively.
- Layouts 16 and 17 – Technical details of the extra-room and sun-space solutions: they represent the horizontal and vertical cross-sections of the other two solutions, developed within the consortium, by the Technical University of Munich (TUM).

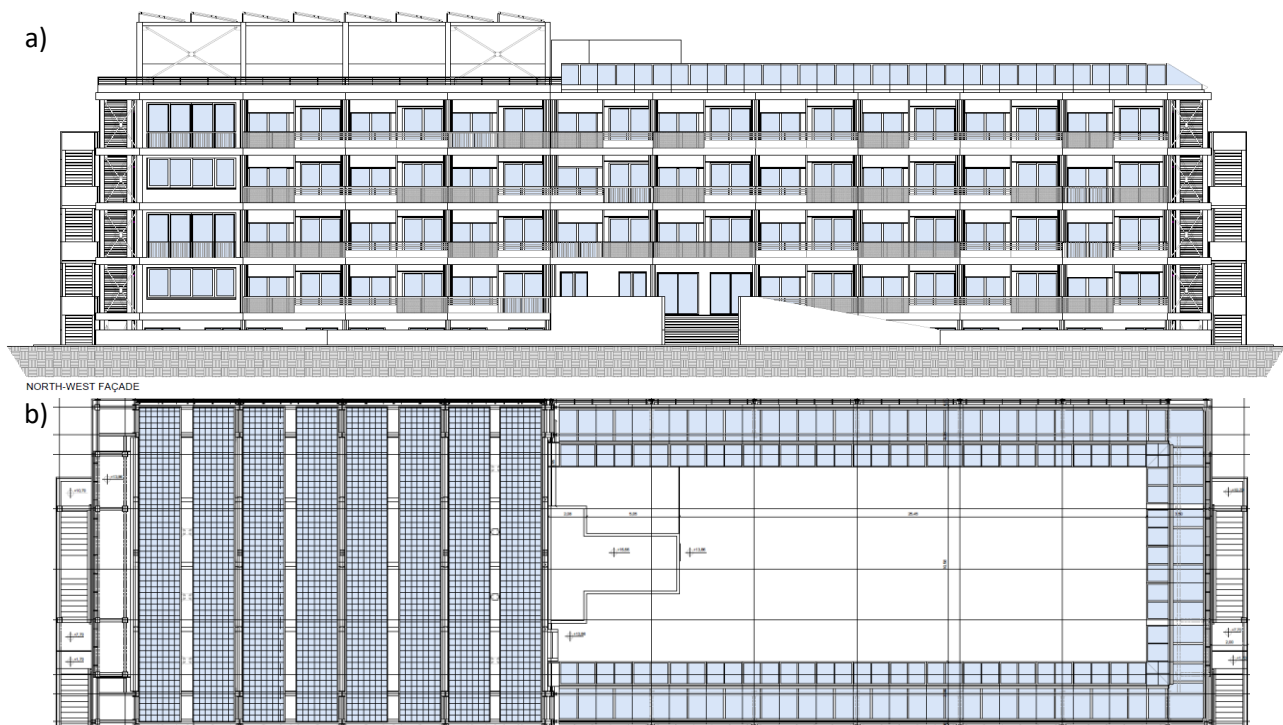

Figure 291 – a) North-west façade; b) plan view of the rooftop floor

As shown by Figure 291, within the design solution presented in Section 5.1, the exoskeleton with the Vierendeel roof extension was proposed for the northern part of the building, while the solution without roof-extension was foreseen for the remaining part in the preliminary architectural design presented here. A series of semi-transparent photovoltaic panels was provided on top of the Vierendeel beams while the Anergdy photovoltaic system (partner of the EU project) was placed on the roof of the outer exoskeleton as a railing system for the remaining roof area.

Figure 292 shows an axonometric vertical cross-section of the building after renovation on the first span taken from the work, done by a master student at the University of Bologna during the transfer of the Pro-GET-onE strategy in the building information modelling (BIM) process. The presence of alternating extra-rooms and sun-spaces on the west and east side for each floor is visible.



Figure 292 – Axonometric vertical cross-section at the first span of the Athens case study after the application of the Pro-GET-onE strategy – Source: [142]



Figure 293 – External representative view of the Pro-GET-onE application on the north part of the Athens case study – developed on the basis of a three-dimensional view taken from [142]

7.1.2 Design challenges and inputs from the consortium

The research focus concerns the technological details of the prefabricated components that make up the new architectural units, as these are the actual living spaces of the project.

During the development of these technical solutions, many challenges were faced in order to achieve the goals set by Pro-GET-onE.

Considering the continuity of the external steel structure, it is indeed of great complexity to accommodate user-oriented solutions, which are independent from each other, efficient, durable and at the same time being composed of prefabricated dry components. Each unit has its own intervention strategy, and the final technological solution aims at solving these variables.

- Balcony and sun-space solutions should provide insulation only to the existing walls, leaving railings and windows to the external side of the structure.
- The extra-room solution, on the other hand, should provide complete insulation around the entire single cell extension.

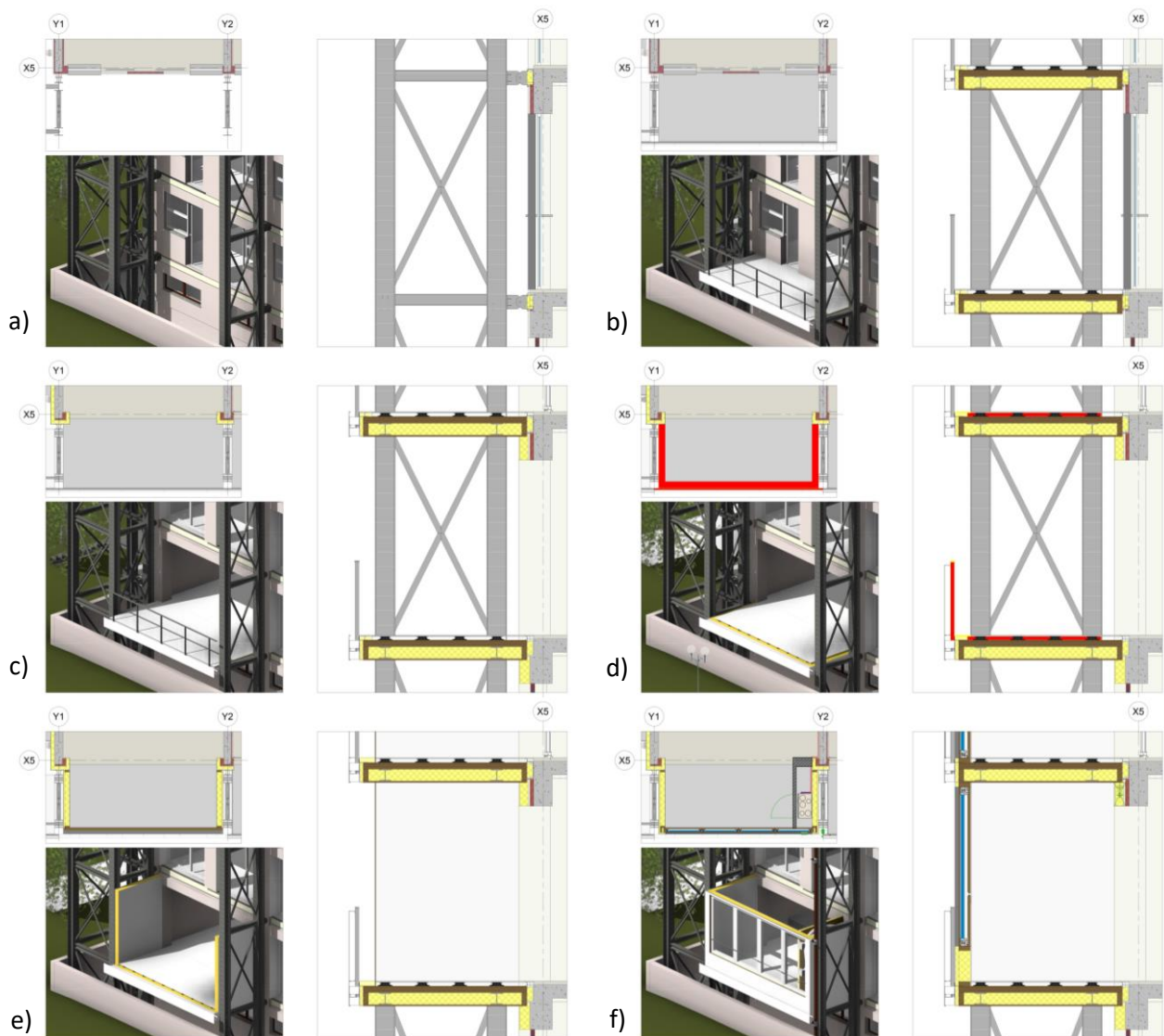

Figure 294 – Assembly procedure of the composed box-solution consisting of: a) positioning of the steel frames; b) positioning of the CLT slabs already mounted on the longitudinal beams, horizontally inserted within the transversal steel frames; c) using the external floor (protected), demolition of the existing façade and installation of the insulating layers on the existing walls (where necessary); d) removal of the railing and of the temporary floor finishing (in case of an extra-room); e) position of the external side walls; f) positioning of the front prefabricated walls – Source: [142]

Maintaining this variability and potentially allowing customers to upgrade their units over time meant that side walls and floor components had to be designed to progressively create architectural units according to user needs/demands.

The first hypothesis developed by the Pro-GET-onE consortium under the guidance of the Chair of Timber Structures and Building Construction of the TUM (task leader for the development of the technical solutions of Pro-GET-onE [95]) involved the creation of the extension units through the composition of individual prefabricated panels, forming the floor, side walls and ceilings of each respective unit. The side walls were placed inside the frames of the steel exoskeleton, already providing the insulation and supported by the floor slabs, the latter being fixed above the longitudinal beam of the exoskeleton, while any layers of insulation were to be provided in the thickness of the longitudinal beams and sealed from the intrados with the ceiling of the units below the one concerned (in the case of the presence of another extra-room) or with a specific false-ceiling in the case of a balcony (Figure 294).



Figure 295 – Photos during and on completion of the mock-up of Pro-GET-onE in the ALIVA Srl plant – Source: [211]

This first composed solution provided CLT slabs for each type of unit and was able to meet the architectural requirements at the price of providing insulation in each composite slab to ensure the future possibility of upgrading the architectural units and to always provide an energy efficient envelope, including water tightness to each individual unit, regardless of which unit was located nearby. In addition, it was also tested in its assembly procedures in the mock-up created through the cooperation of TUM and ALIVA Srl as part of the EU project (Figure 295).

The experience developed through the construction of the mock-up highlighted some critical points, such as:

- the collision of the corner of the CLT slab with the existing building or the perimeter UPN;
- the collision/correct positioning of the CLT slabs inside the metal frames;
- thermal bridges created by the longitudinal metal beams inside the floors, with consequent complexity related to water tightness;
- difficulties in assembling the prefabricated panels that form the new insulation of the existing façade in the case of balcony or sun-space solutions;
- difficulties for the assembly of boxes as they are composed of single pieces, the lifting of the panels is facilitated at the expense of a complex assembly procedure, considering the rotation of the panels, the positioning in exact position, the fixing, and the subsequent sealing of the residual gaps (tolerances necessary to allow the movement of the single panels inside the frame).

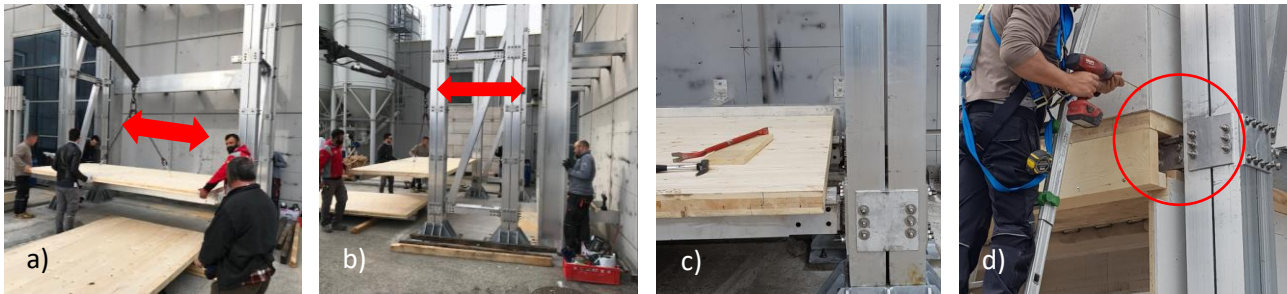

Figure 296 – a) and c) photos highlighting the longitudinal tolerances required and the collision encountered during placement of the CLT slabs; b) photo highlighting the transverse tolerances required and the collision with the existing façade; d) photo highlighting the thermal bridge created by the longitudinal beams within the composite slab – Source: [211]

As a result of the mock-up experience, the Pro-GET-onE consortium [95], led by the partner TUM, focused on minimising these issues and developed an alternative solution for constructing extra-room and sun-space living units (currently adopted for the prototype design).

This solution is presented in the next section and also represented in the full definitive architectural design developed by the author in order to fully describe the technological details of the integrated system applied to the whole building but involving the author of the manuscript only as a collaborator (see Appendix). On the contrary, the balcony solutions, within the three main units proposed by Pro-GET-onE were developed mainly with the contribution of the author as member of the design team of the University of Bologna, under the supervision of TUM (task leader).

7.1.3 Technical details and applications

7.1.3.1 Extra-room and sun-space

Technology

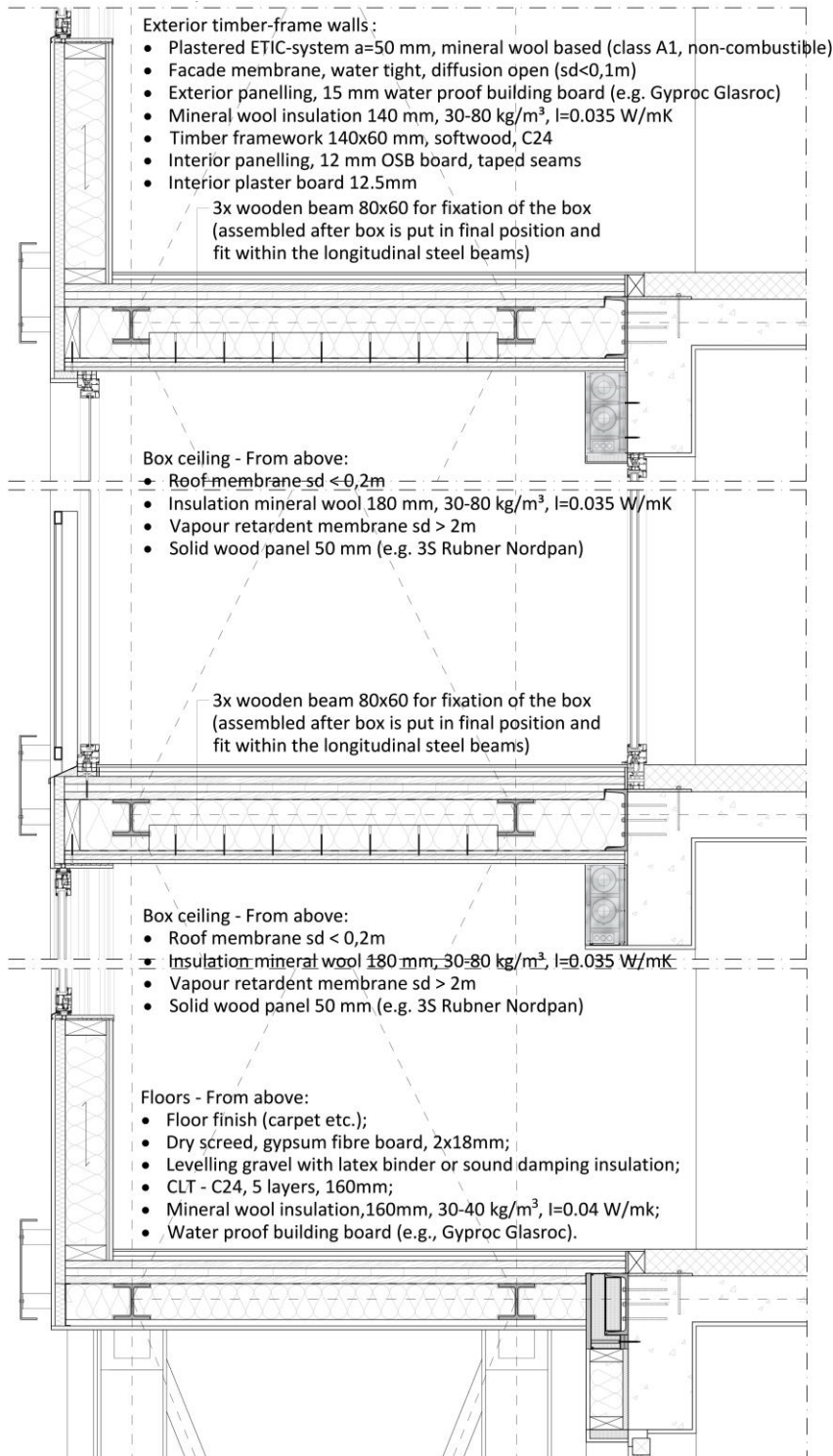

Extra-room and sun-space were designed to be in the first bay of the Athens case study, on alternating sides on each floor. This choice was dictated by the need to reduce the construction cost of the entire renovation, and therefore to reduce the number of prefabricated wood-based panels for the units and the surfaces of insulating layers.

The proposed solution for the construction of extra-rooms and sun-spaces was once again based on the wooden box concept, which best meets the requirements of thermal efficiency, water tightness and prefabrication. However, in this case, the assembly procedure was intended to provide complete prefabricated boxes to be inserted inside the exoskeleton, both before and after the installation of the longitudinal steel beams. Insulation was then provided inside the boxes during the progressive assembly phase, from the base to the roof. To fix the boxes to the exoskeleton, wooden beams were provided above the wooden ceiling panel and embedded or rigidly connected to the longitudinal beams.

The materials and the stratigraphy are best shown in Figure 297 and the layouts in the Appendix.

Figure 297 – Vertical cross-section at the first span of the student house in Athens, showing the technology provided on the first floor and for extra-room and sun-space units – Developed by following the design input from TUM within [95]

Energy efficiency

The developed solution guarantees a high level of thermal insulation and could be adjusted according to the custom executive designed for the energy requirements of Athens. Based on the drawings shown in Figure 297, the following conductivity values for the opaque parts can be calculated (Table 202).

Table 202 – Conductivity values associated to the external vertical partitions; to be customised to the Athens energy requirements

Element of the boxes	Positioning	Unit	U (W/m ² K)
Prefabricated timber-based wall	External front	Extra-room	0.196
Prefabricated timber-based wall	External side	Extra-room/sun-space	0.196
Floor	Type floor	Extra-room/sun-space	0.182
Floor	First floor	Extra-room/sun-space	0.192

The amount of insulation and therefore the thickness of the prefabricated panels should then be customised according to the energy needs of the intervention area. The window and doors in the project should be selected to meet to the current nZEB requirements (Section 3.2).

Assembly procedure

Figure 298 – Box assembly procedures: a) bare RC frame; b) positioning of steel exoskeleton; c) positioning of insulation on the existing façade (where necessary); d) horizontal insertion of boxes within a completed exoskeleton; e) alternative procedure, installing the longitudinal steel beams progressively after the positioning of the lower box, going up to the roof – Source: [211]

The assembly procedure designed for the extra-room and sun-space is shown in Figure 298 and could involve two strategies:

- insertion of the pre-assembled wooden boxes within a completed exoskeleton (Figure 298d), proceeding from the base towards the roof, placing the necessary insulation layers and fixing beams at each ceiling, prior to the installation of the upper box;
- insertion of the pre-assembled wooden boxes vertically (Figure 298e), prior to the installation of the longitudinal steel beams; these are mounted to the transverse frame of the exoskeleton together with the layers of insulation and the transverse wooden fixing beams above the previously positioned box, proceeding from the base to the roof.

Once two or more consecutive boxes have been installed, the finishing components on the outside of the building (stringcourse, sealing insulation part, finishing layers and eventual guttering) are mounted.

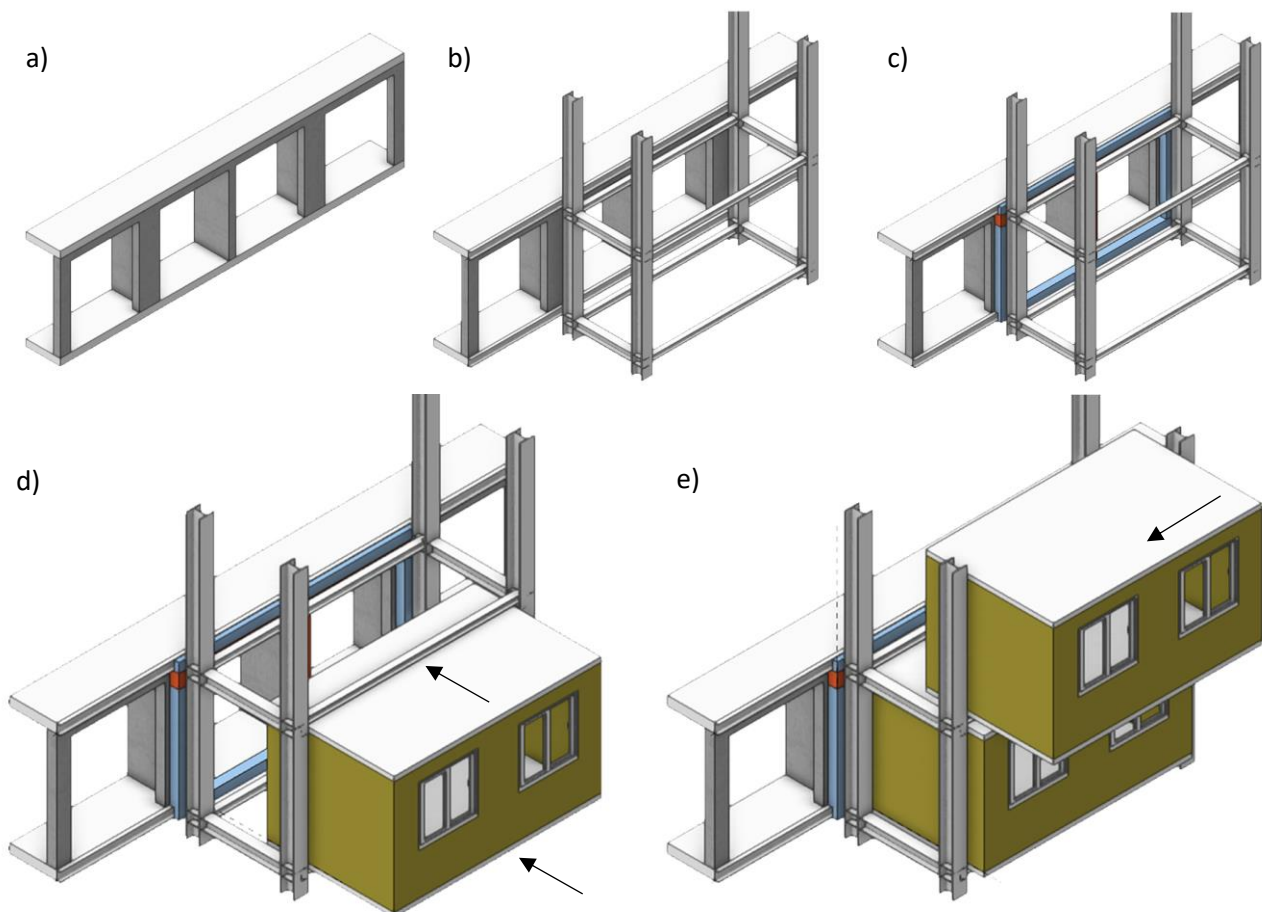
Figure 299 shows a practical example from NEST (EMPA, CH), where the box was lowered, detached from the first line of ropes, and pulled inside the structure, using steel/teflon rails.



Figure 299 – Example of assembly procedures of wooden prefabricated boxes from NEST (EMPA, CH) – Source: [211]

7.1.3.2 Balcony

As mentioned in the previous section, the architectural design of the technological system was aiming at minimising the construction cost. Three main proposals for the construction of the balconies were identified within the project, based on different inputs from the consortium.

- A solution consisting of corrugated steel sheets (CSS) with lightweight (LW) concrete slabs, developed under suggestion of the Athens construction company. They suggested the use of established techniques in order to minimise costs related to raw materials and specialised personnel.
- A solution composed of prefabricated aluminium slabs, developed with the contribution of ALIVA Srl.
- A solution composed of CLT slabs with prefabricated technical beams, developed under the supervision of the Chair of Timbers Structure and Building Construction at TUM.

For all the developed solutions, the envelope renovation was foreseen on the existing surfaces, either with prefabricated insulation wood-based panels or with more traditional applications, installed in front of the parts of the façade not affected by the presence of window or door frames (around and covering the external part of the RC frames).

In front of the perimeter longitudinal RC beams, a prefabricated component (HVAC beam), which contains the pipe distribution and includes insulation material, provides the necessary renewal of the envelope. This rectangular box must also include a prefabricated L-shaped insulating case above it to complete the envelope in front of the perimeter UPN that forms the structural connection between the two structures. The same solutions for the renovation of the envelope have been provided for all the following proposed solutions.

Technology – Corrugated steel sheet with LW concrete slab

The most cost-effective solution developed for the balcony unit involved prefabricating a lightweight (LW) slab cast in corrugated steel sheet (CSS) panels attached to the longitudinal beams. The threaded rods passing through the HEB flanges and the CSS were cast into the LW concrete, ensuring a rigid and finished element to be lifted and installed to the transversal steel frames during the erection procedures. The balcony slope was designed and constructed during the casting of the LW concrete.

The railing system includes L-shaped uprights that pass through the voids formed by the CSS and are already fixed to the longitudinal steel beams. The uprights also support the stringcourse along the bays, together with additional plates attached to each steel column. Alternatively, a further solution provided a RC kerb on the edge of the composed slab to allow easier attachment of the uprights to the side of the slabs. The materials and stratigraphy are best shown in Figure 300a and layouts in the Appendix.

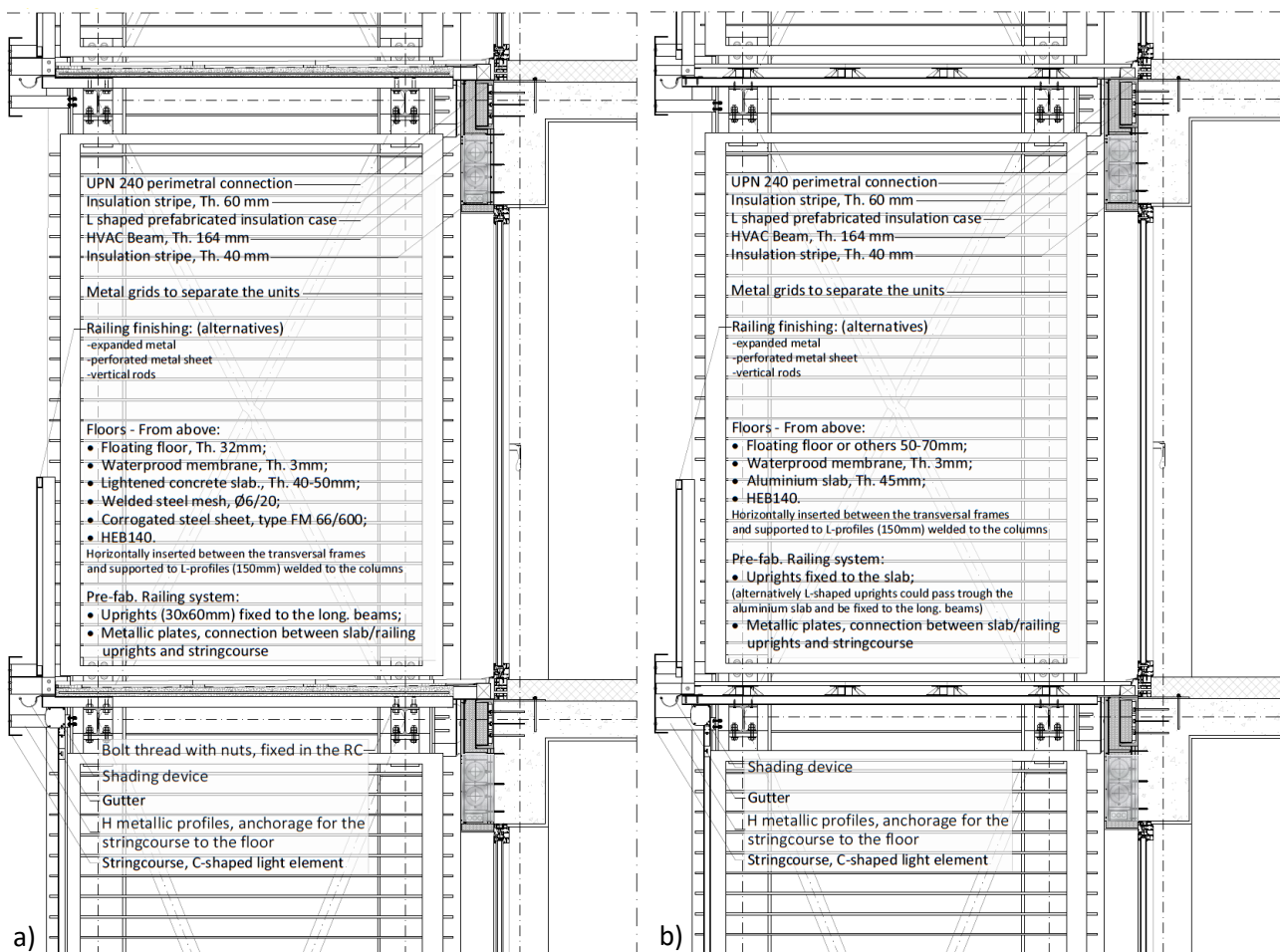

Figure 300 – a) Vertical cross-section showing the technology provided for the balcony solution with CSS and LW concrete slabs; b) vertical cross-section showing the technology provided for the balcony solution with aluminium slabs

Technology – Aluminium slab

The aluminium solution was developed on the basis of the structural element suggested by ALIVA Srl, and simply foresees the use of aluminium slabs interlocked with each other along the longitudinal direction and spanning between the steel HEB beams. As in the above solution, the uprights could be fixed either to the longitudinal beams (using L-profiles) or above the slabs (as in Figure 300b).

The balcony slope, not shown in Figure 300b, would have to be provided by tilting the aluminium slab, inserting shims over the longitudinal beams.

Figure 301 shows both balcony metal solutions developed for the Athens project.

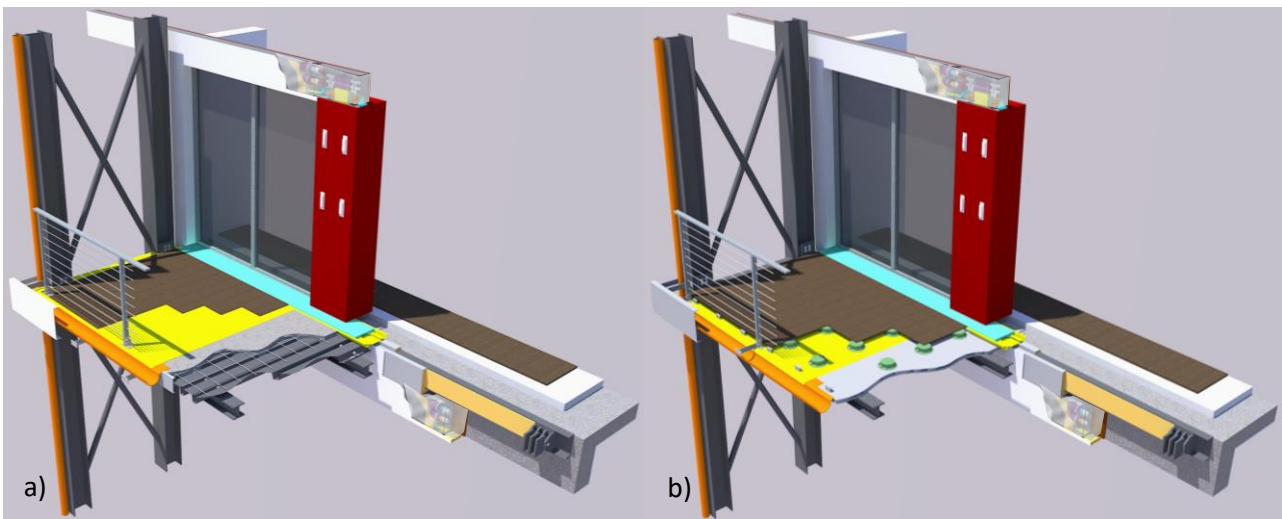

Figure 301 – a) Axonometric view showing the technology provided for the balcony solution with CSS and LW concrete slabs; b) axonometric view showing the technology provided for the balcony solution with aluminium slabs

Technology – CLT slab

During the detailing of the prototype, some problems were identified in the above-mentioned solutions and consequently an alternative was developed, consisting of CLT slabs. This alternative was also promoted by the possibility to decrease the solutions variability for the final implementation by identifying a single supplier for all structural floor components of the units, considering boxes and balcony floors.

- The CSS with LW concrete solution turned out to be a relatively heavy solution and, in the opinion of the Greek construction company, also risky to lift, which could generate cracks in the concrete during installation and compromise the quality of the finish.
- The aluminium solution, on the other hand, was a feasible solution except for the lack of adequate detailing, the difficulty in designing the connections with the longitudinal beams and the railing, and the possible problem of poor sound insulation.

The two CLT solutions presented here were therefore designed under the supervision of TUM and differentiated according to the approach to create the slope of the slabs.

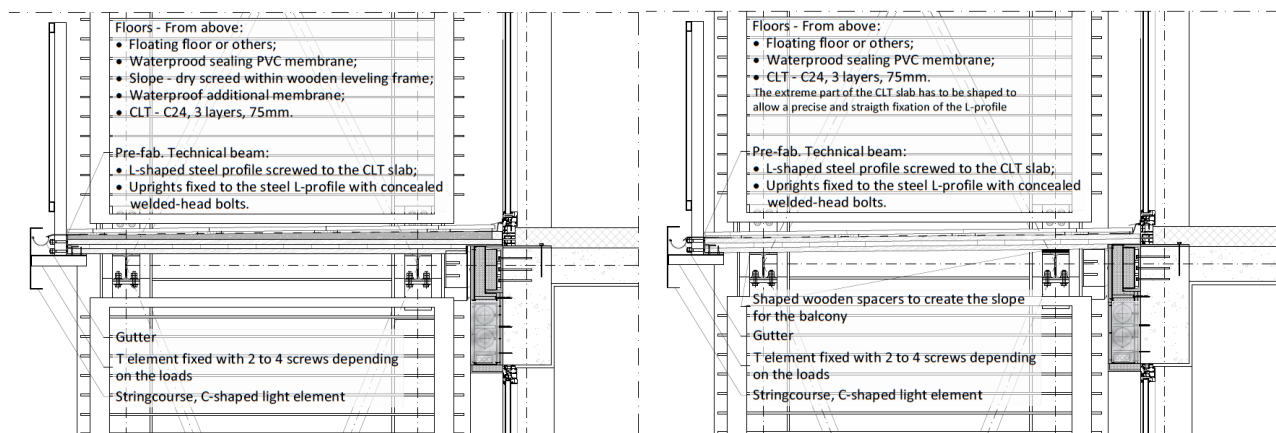

Figure 302 – a) Vertical cross-section showing the technology provided for option 1 of the balcony solution with CLT slabs; b) vertical cross-section showing the technology provided for option 2 of the balcony solution with CLT slabs

The three layers CLT slab (75 mm) were fixed directly on the longitudinal steel beams for the first option (Figure 302a). The slope was then created above the CLT slabs through the use of a dry screed within timber

levelling frames. The second option (Figure 302b) was to create the slope by inserting and fixing special shims between the longitudinal beams and the CLT slabs, thus avoiding the use of dry screed.

For both solutions, the railing system is created through the use of a prefabricated L-shaped technical beam, fixed laterally to the CLT slabs and equipped with bolded uprights with concealed welded-head bolts. The materials and stratigraphy are better illustrated in Figure 302 and the layouts in the Appendix.

Assembly procedure

The assembly procedure is the same for all proposed technical solutions. After cutting the existing balcony, the UPN steel perimeter profile is fixed around the RC structure at slab level together with parts of the hinge connection (Figure 303a). Pre-assembled (welded) steel transverse frames are installed on the reinforced concrete foundation (three levels at a time), carefully matching the foundation anchors and hinges along the height of the existing building (Figure 303b).

- The steel transverse frames provide two (or one, if it is continuous) steel plates at the necessary height to connect the longitudinal beams with a semi-rigid joint. The lower steel plate has a L-shaped profile to facilitate the assembly procedure (Figure 303b).
- The horizontal insertion of the slabs could be done without any technical devices, from the outside to the inside of the exoskeleton through the use of a crane, proceeding directly to the step in Figure 303d.
- If a rail is required to install the already composed slabs with the longitudinal beams, a sliding system could be provided and temporary fixed on the L-shaped connectors (here sketched with a U-profile with wheels, but it could consist of a single plate as a rail for the horizontal sliding). This system can facilitate the horizontal movement of the whole slab from the outer edge to the inner span of the steel frame, without encountering a relative movement that could block the slabs between the columns (Figure 303c). The sliding system could also be cantilevered to capture the floor from outside the columns.
- The longitudinal beams have an end plate already welded to be connected to the upper steel plate fixed on the columns. The L-shaped connectors will be bolted to the bottom wings of the HEB profile with the use of double fixed nuts (Figure 304b).
- When the slab is in position, the crane can pull it up to remove the sliding system, allowing the slab to be properly positioned and secured to the steel frames (Figures 304a and 304b).
- The same sliding system can be re-used floor by floor for each slab and progressively ascending towards the roof.

Figures 303 and 304 represent the steps of the proposed installation procedure for the balcony slabs.

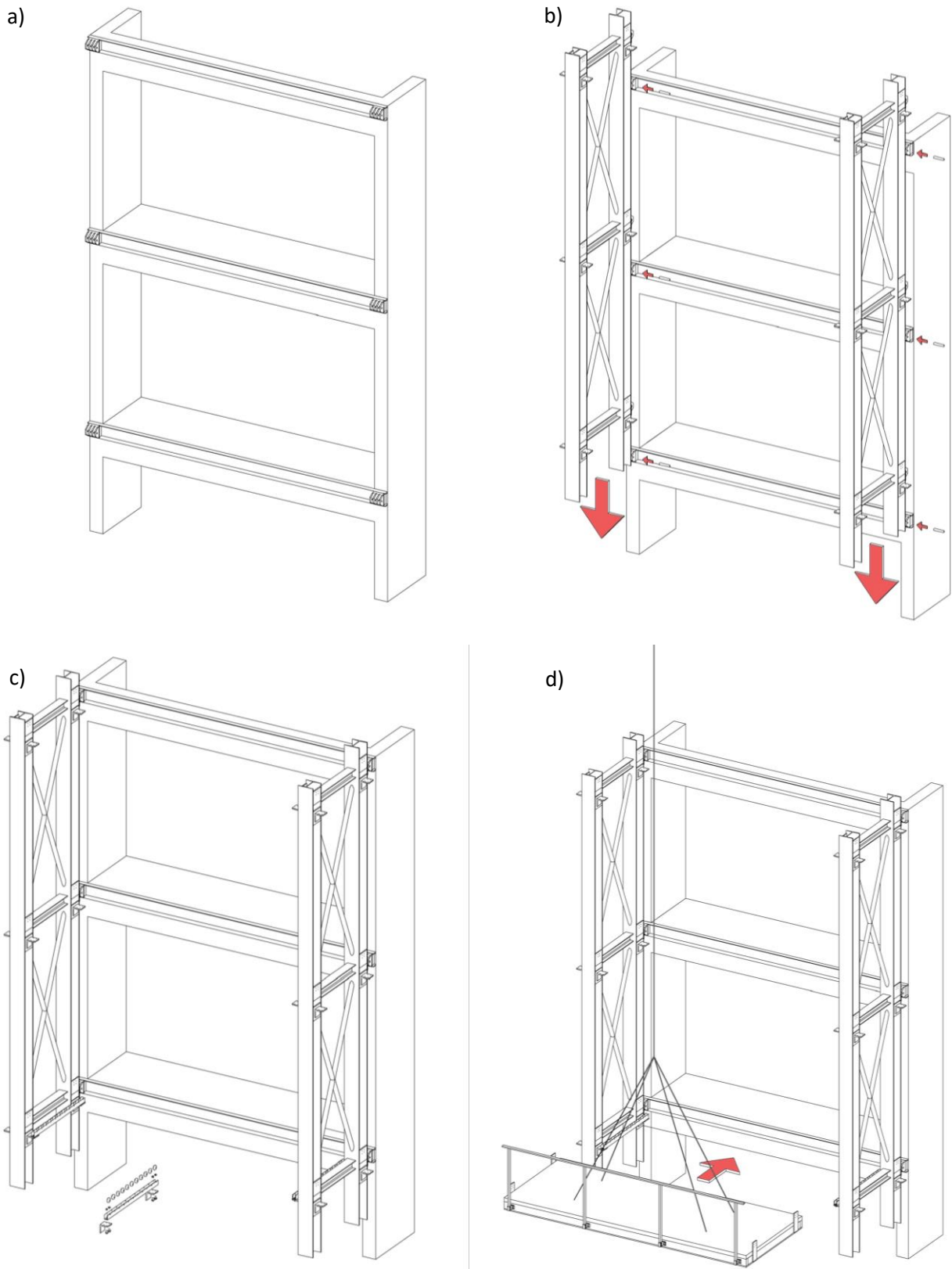

Figure 303 – a) Fixation of the UPN steel perimeter profile with parts of the hinge connection; b) installation of the steel transverse frames of the exoskeleton; c) installation of the sliding system on the ready-made supports for the longitudinal beams; d) horizontal sliding of the balcony slab

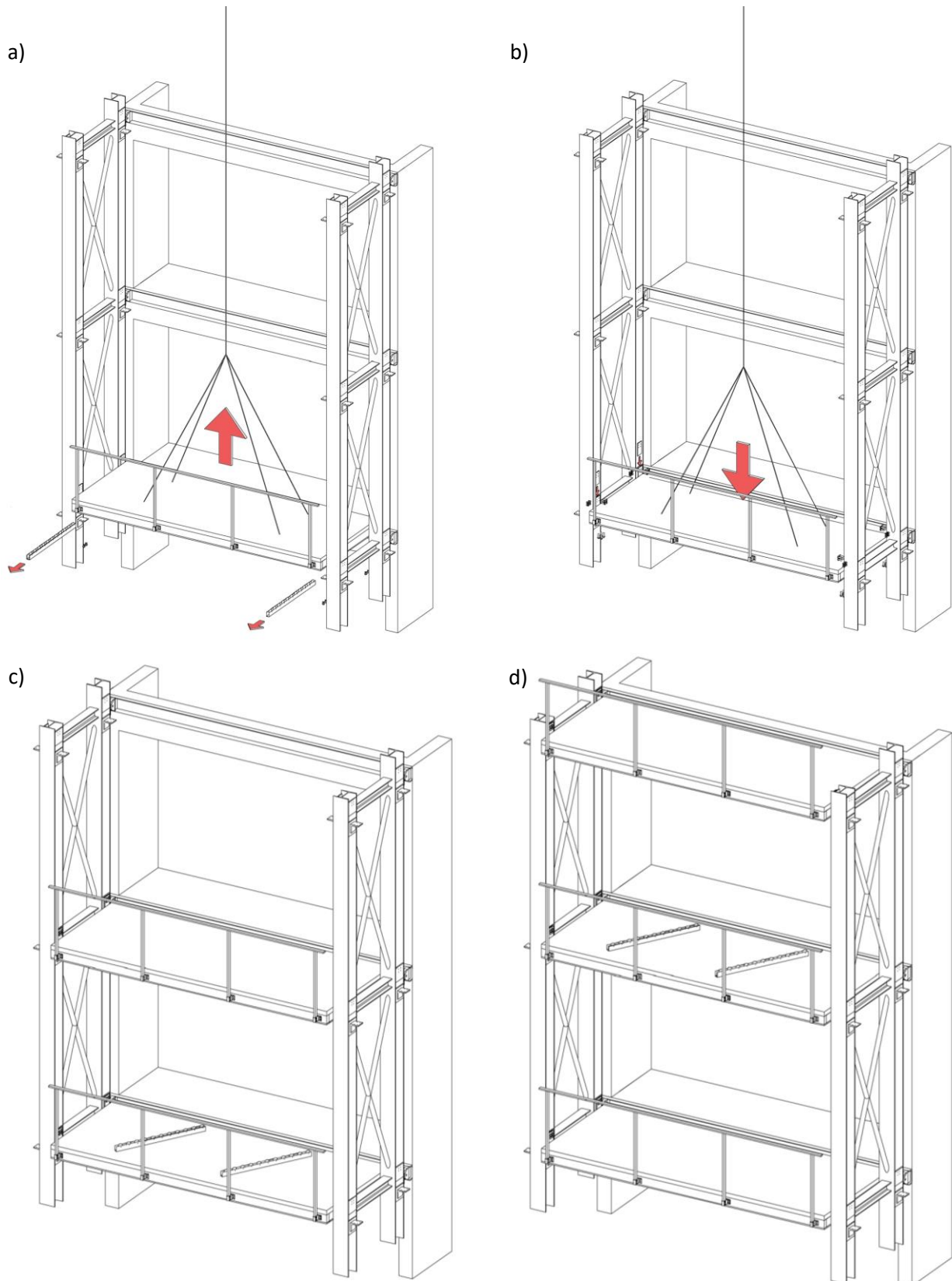

Figure 304 – a) Lifting the slab to remove the sliding devices; b) correct positioning of the slab on the L-supports; c) re-use of the sliding devices for the upper slab, using the lower slab as a scaffold; d) repetitive procedure until the roof

7.2 The Brasov design – on the timber exoskeleton

The wooden technological solution was designed on the case study of Brasov. The layouts produced for the thesis were applied on the MRF case located in Brasov to identify also the distributed vertical connection between the exoskeleton and the existing RC structure. As mentioned in Section 5.3, the exact structural system was verified and applicable as an independent extension to the homeless dormitory in Brasov. The same technology could be provided with the only exception of the provision of a seismic joint between the two structures to allow relative displacements and avoid any hammering between the structures.

The work described in this section differs from the prototype envisaged by Pro-GET-onE and although it follows the same design principles, it was not provided by the main project. Therefore, the whole architectural design was carried out by the author during his research period at TUM.

7.2.1 Overview of the renovation project

Both structures in Brasov were introduced in Section 5.3. Regarding the main building (homeless dormitory located in Romania), based on data available from the Pro-GET-onE reports [4], it was also possible to determine annual share of energy consumption for heating, which is around 85'000 kWh/year and, considering the overall efficiency of the heating system, it was estimated that the total primary energy consumption is circa 100'000 kWh/year. In order to estimate the energy performance of the Brasov case study, it can be assumed that the overall consumption for a reference building is about 150 kWh/m²year, while for the existing building it is about 200 kWh/m²year [4]. During the assessments done in 2015, the building was classified in class B, which means that the energy measures (external coat) implemented in the previous renovation improved the initial configuration, but the energy performance is still poor, especially during winter. In 2015, the building was investigated with the aim of proposing a use conversion from dormitory to social housing (Figure 305). In particular, the project mainly focused on the internal partitioning: creating new openings between units and reorganising the interior spaces, renewing the internal installations, floor technical systems, and finishes.

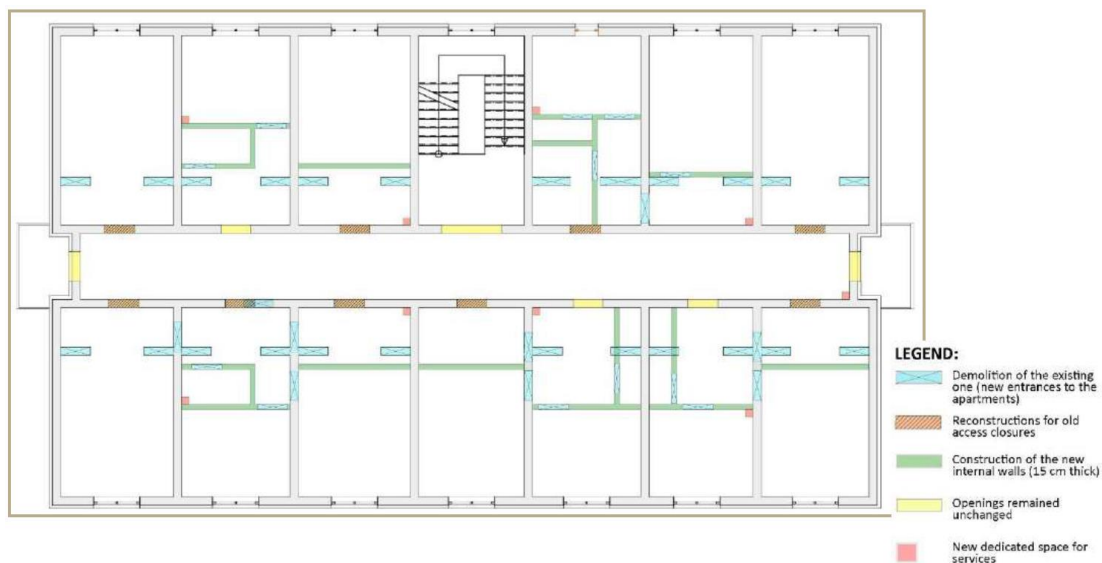

Figure 305 – New internal distribution provided by the renovation project independently commissioned from the municipality of Brasov

Therefore, again as with the Athens case study, the renovation provided by the Pro-GET-onE strategy [95] is in continuity with an internal renovation. The main issues addressed by the external project are therefore similar to those presented in the previous chapter:

- additional space: the addition of the new housing units is foreseen by the extension through the exoskeleton (focus of this section) and could be combined with the new distribution of the internal spaces;
- thermal comfort: through an adequate HVAC system including the renovation of systems inside and/or outside the building envelope (aspect not covered in this research);
- safety: through an adequate strengthening structure to improve the seismic performance of the existing building (section 5.3, considering the MRF RC building).

Regarding the application strategies of the exoskeleton, it was mentioned that the flexibility of the technique is also determined by the use of different materials depending on the climate or the needs and possibility of the users and owners. Given the need to enhance the environmental sustainability, increasing the amount of CO₂ stored, and decreasing gas emissions with efficient envelopes, technical systems, and renewable resources. The use of the wood-based component applied to the CLT-structure allowed a homogeneity of materials linked to advantages in terms of costs, time, and construction procedures, without mentioning the considerable reduction of environmental impacts. Wood, as introduced in Section 4.4, allows a high degree of prefabrication, speeding up the assembly phase and being easy to transport and to manage due to its low weight.

The design envisages extensions for each room, combining the exoskeleton structure with the existing one, creating new spaces with different uses (Figure 306). The extension will have a depth of 2 m and can be divided into three main uses: balcony, sun-space, and extra-room. The technological components that create these units represent the main challenge for the architectural design and are described in the next sections.

The arrangement of the new units on the façade has been proposed as fixed on one type or with a randomly chosen distribution (Figure 307a).

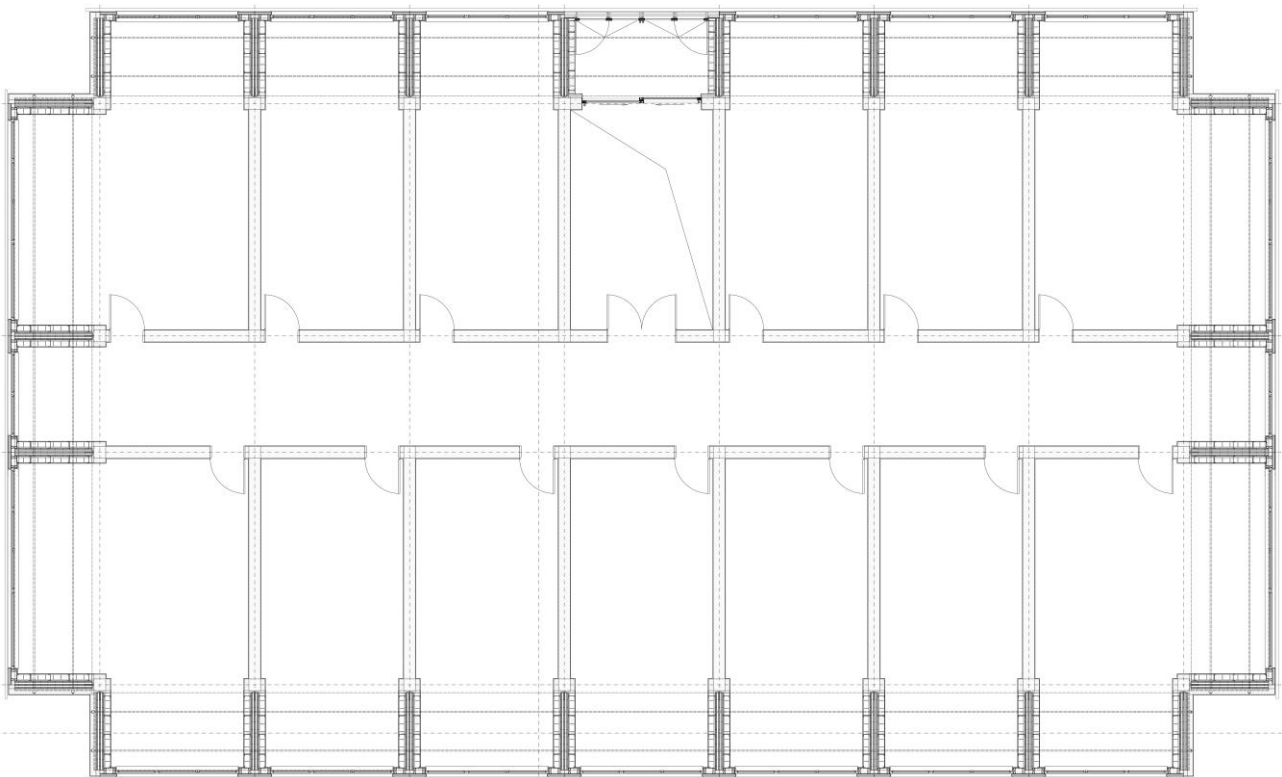

Figure 306 – Technical drawing of the plan of the type-floor of the wood-based exoskeleton applied on the MRF RC Brasov case study, showing the architectural extension of the existing building providing extra-room units

In order to present the design of the alternative wood technological system, the author developed a series of technical drawings based on the structural application presented in Chapter 5.3.3. The main efforts were

spent on the individual architectural units and later on extending the application to the whole scale of the building. Additional details, such as foundations and roof joints, were then developed up to a scale of 1:10, while considering a simplified level of detail compared to the previous application, due to the different exploitation requirements.

- Layout 1 – Architectonic elevations of the project state: they represent the façades after the application of the Pro-GET-onE wood-based solution considering different distributions of architectural units (e.g., Figure 307a).
- Layouts 2 – Architectonic plan of the typical floor of the project state: represents the planimetric development after the application of the Pro-GET-onE wood-based solution considering the application of the extra-room solution on the whole perimeter (e.g., Figure 306).
- Layout 3 – Vertical cross-sections of the project state: represent the vertical cross-sections of the Pro-GET-onE wood-based solution considering the application of the extra-room solution on the whole perimeter (Figure 307b).
- Layouts 4 to 6 – Technical details of balcony, sun-space and extra-room solutions respectively: represent the horizontal and vertical cross-sections of the technological solutions for the construction of the architectural units in the wood-based exoskeleton.
- Layout 7 – Technical details of the foundation and roof joints for all three technological solutions (detailed vertical cross-sections).



Figure 307 – a) Main façade of the project-state considering a randomised distribution of architectural units; b) vertical cross-sections of the project state considering the project-solution that provides only extra-room as architectural units of extension

As shown in the Figures 306-308, the level of detail has been reduced along with the representation and design of the plant systems, the positioning of the renewable sources, and the pipes distribution, focusing exclusively on the technological units.

The use of PT connections between the horizontal and vertical CLT panels allowed to maintain the architectural freedom of the façades and, as presented in the Section 7.2.3, to speed up the assembly procedure of the timber exoskeleton.

While Figure 308 shows parts of an architectural section of the units, showing a possible insight of the resulting integrated system, Figure 309 represents an external view of the project application taken from the work done by a master student at the University of Pisa during her international experience at TUM. A random distribution of extra-rooms, sun-spaces and balconies is visible.



Figure 308 – Architectural vertical cross-section of part of the Pro-GET-onE wood-based extension – Source: [159]



Figure 309 – Representative external view of the applied timber extension with the elevation development of the Brasov case study – Source: [159]

7.2.2 Design challenges

It is important to mention two main problems encountered in the renovation strategy adopted. Both also concern the steel-based solutions, although they have become more evident in the current feasibility study.

The first one concerns the reduction of light inside the existing units, here more relevant due to the massive opacity of the side walls of the wooden portals. In this regard the same feasibility study was investigated at the University of Bologna by a master student [212], reporting different results in term of spatial daylight autonomy (sDA) and annual sunlight exposure (ASE). A substantial distinction emerged between north and south environments when it comes to natural light. On the north side, no room has a level considered sufficient for sDA, while it always has acceptable levels of ASE. The south side, on the other hand, showed that most rooms have good lighting, often with very high values especially for the top floors. The ASE parameter, however, was often reported to be out of the limit. The large gap between the two sides underlined the need to apply different interventions, dividing the project according to the geographic orientation. While shading devices were required for the south side for an extension depth of 1.2 m (Figure 310), on the north sides they could be avoided and replaced with other devices in order to let in more sunlight. The exploitation of devices that distribute light from the front openings, such as light shelves [213] or from the roof as solar tubes, could mitigate this problem.

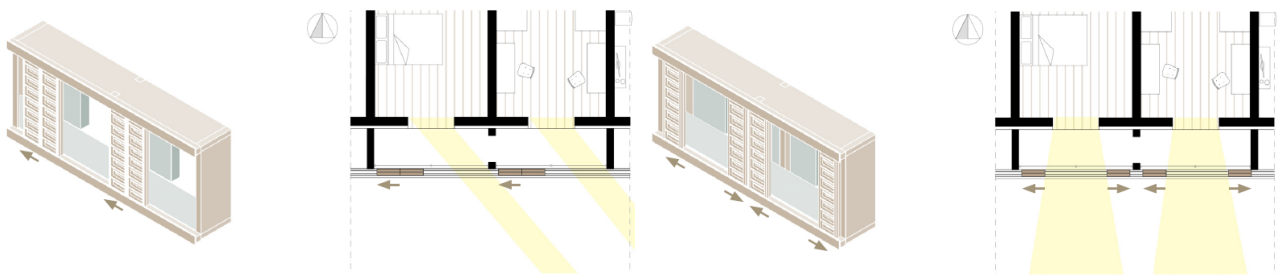

Figure 310 – Positioning of shading devices on the south façade: a) morning configuration; b) midday configuration – Source: [212]

The second problem depends on the case study and its usable height. Characteristic of this case study, and of many similar residential building stocks, is the limited interstorey height, often defined to meet the minimum usable height required by the regulations by virtue of an optimised design. Consequently, when the height of the existing structural slab (RC) is less than the thickness of the structural extension (CLT), there will be a decrease of this height. To minimise this problem, it is therefore necessary to at least standardise the architectural solutions adopted for each façade, avoiding the installation of insulation on each additional floor, and closing the heated cores either outside the addition (all extra-rooms) or on the edge of the existing façades (variable balcony or sun-space). For this reason, the first layout of the Appendix concerning the Brasov case study presents four possible façades, considering the different technological units. Moreover, all details of the technological units are proposed in this case study and are designed, considering a standardised solution for the whole façade in order to guarantee a feasible usable height.

It is therefore evident that the possibility of providing user-oriented solutions clashes with the boundaries of standard and hygiene requirements of liveable residential spaces. This issue is strictly dependent on the morphology of the existing building and needs to be addressed either by specific exemptions for the application of the innovative technology, perhaps by imposing more stringent requirements in terms of forced or natural ventilation of rooms, or by changing the renovation strategy.

7.2.3 Assembly procedure of the wood-based exoskeleton

Thanks to the use of prefabricated wooden elements and post-tensioned connections, the assembly procedure of the structure is designed to be fast and practical. The steel connection plates provide a useful temporary support for the slabs until tension is applied. The timber lightweight means that time and costs are reduced.

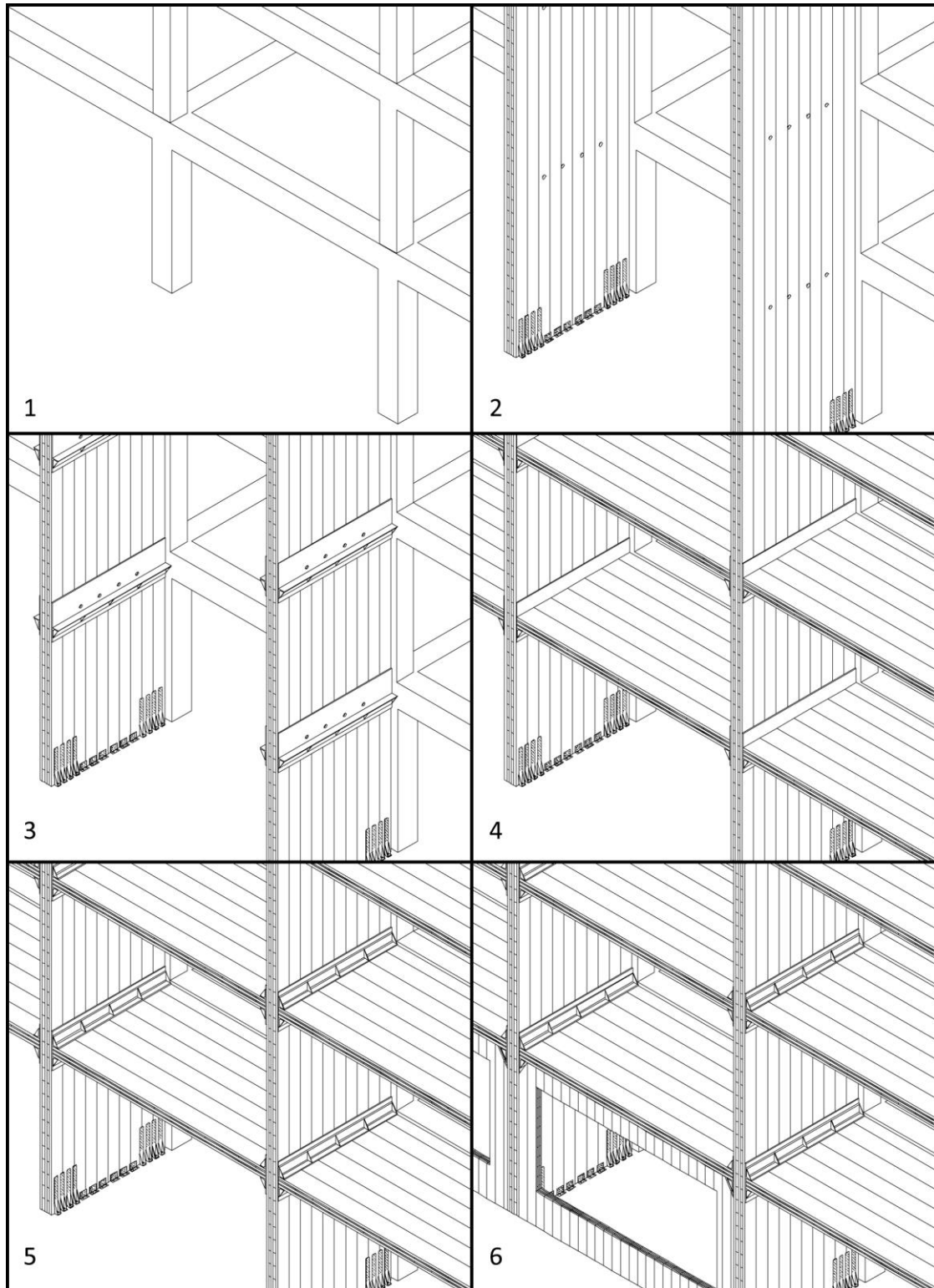

Figure 311 - Sketches representing the steps of the assembly procedure of the PT-CLT structure

In order, as shown in Figure 311:

- CLT walls are fixed to the foundations; the latter must be appropriately designed according to the morphology of the existing ones, design loads and soil condition;
- steel plates without the top angle profile and providing steel pipes as shear keys are inserted into specific holes in the CLT walls;
- the horizontal CLT slabs are raised and laid on top of the steel L-profiles;
- the cables are inserted, and the steel composite plate is closed with the upper L-profile;
- the entire system is tensioned and the CLT panels are installed at the ground floor;
- after the CLT portals have been tensioned, the prefabricated architectural components (façade panels or technical beams) can be applied to the outer side of the exoskeleton.

It is important to underline the disruption that could be generated during the construction of the foundations and the application of the connectors to the existing RC columns that could be related to local strengthening.

7.2.4 Technical details and applications

7.2.4.1 Extra-room

Technology

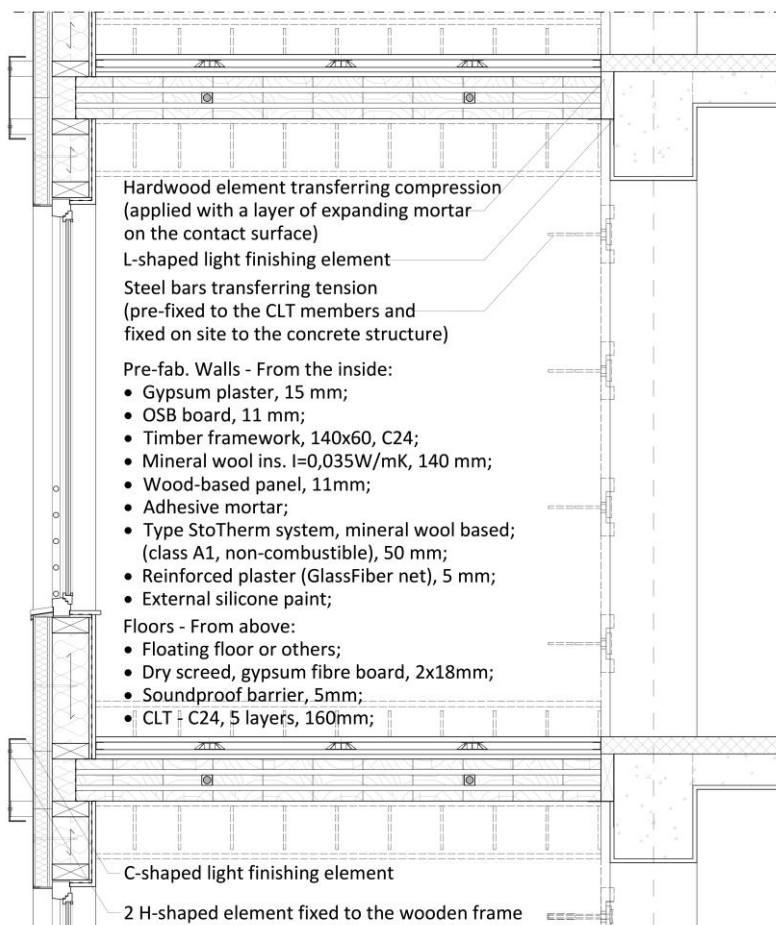

Figure 312 – Vertical cross-section showing the technology provided for the extra-room solution within the CLT portals

The proposed solution for the construction of extra rooms is based on the use of prefabricated timber-frame panels, integrated with window frames, and applied on the side edges of the CLT portals. The assembly procedure is simpler than for the steel exoskeleton, as the wood-to-wood fixings allow immediate and efficient results. Particular attention must be paid to the joint between two prefabricated panels at the floor level. In a second phase, together with the stringcourse supports, a string of external insulation could be fixed to complete the façade; or, alternatively, the external part of the insulation could protrude above and below the frame of the CLT portals to complete the external façade (without excluding the need to check and close any openings, to be carried out together with the installation of the stringcourse).

Materials and stratigraphy are best shown in Figure 312 and in the layouts of the Appendix.

7.2.4.2 Balcony

Technology

Figure 313 – Vertical cross-section showing the technology provided for the balcony solution within the CLT portals

The insulation layer is provided on the existing façade in front of all unprotected portions. However, due to the depth of the extension, the design should provide large openings, limiting the amount of this insulation layer to a minimum. Specific calculations on possible thermal bridges in the vicinity of the connection between the two structures should determine whether or not a false wall (counter wall) is required on the CLT transverse panels in order to insert an additional layer of insulation to avoid them.

The quickest assembly procedure would provide the possibility to have the finished pre-assembled slabs, already fitted with the technical steel L-beam and the dry screed sealed by the membrane, during the installation of the CLT structural slabs. However, damage to the membrane and the layers of the final solution could occur during construction, especially with the need for supports to lift the slabs into position.

Therefore, an assumed optimal assembly procedure would continue after the finishing of the CLT-based exoskeleton, installing the front technical beams to level the slope of the dry screen and to ensure workers protection during the finalisation of the floors.

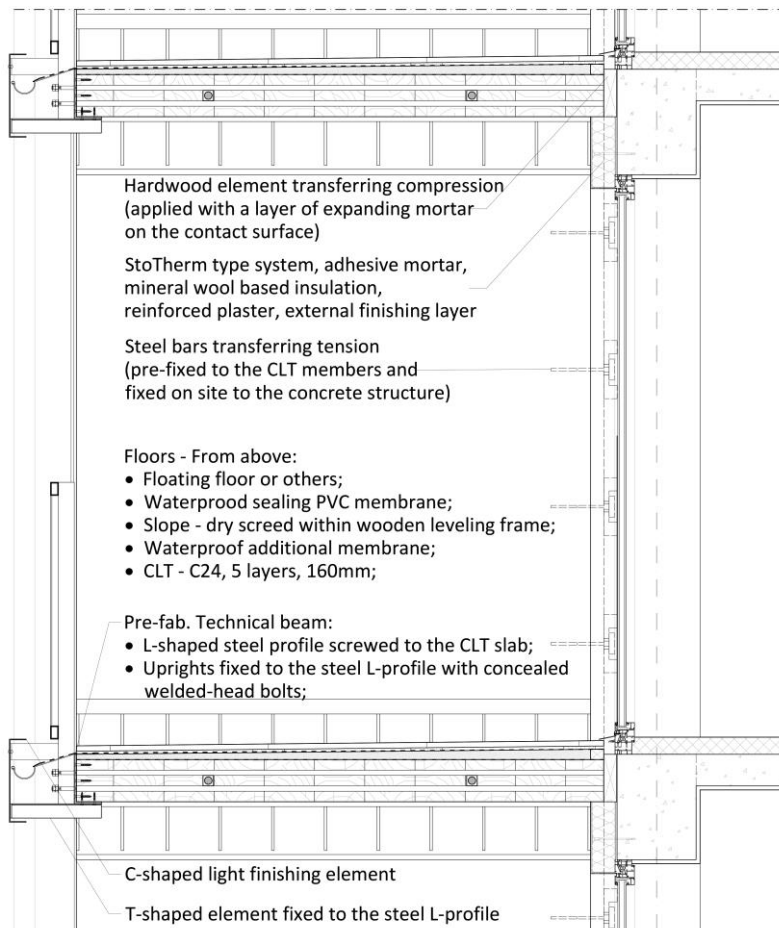
The proposed solution for the balcony construction is based on the use of prefabricated L-shaped technical beam that combine the edge of the slabs, the uprights, and the stringcourse supports. The balcony slope is created with a dry screed placed inside a levelling frame attached directly to the CLT slabs. A waterproof membrane and a finishing floor complete the stratigraphy shown in Figure 313 and in the layout in the Appendix. The uprights are already bolted to the L-profile by means of concealed welded-head bolts that allow the beam to be uniformly approached from the side of the CLT panel. This technical beam provides the supports for the stringcourse and is L-shaped so that it has two free sides for the application of the screws on the CLT panels.

7.2.4.3 Sun-space

Technology

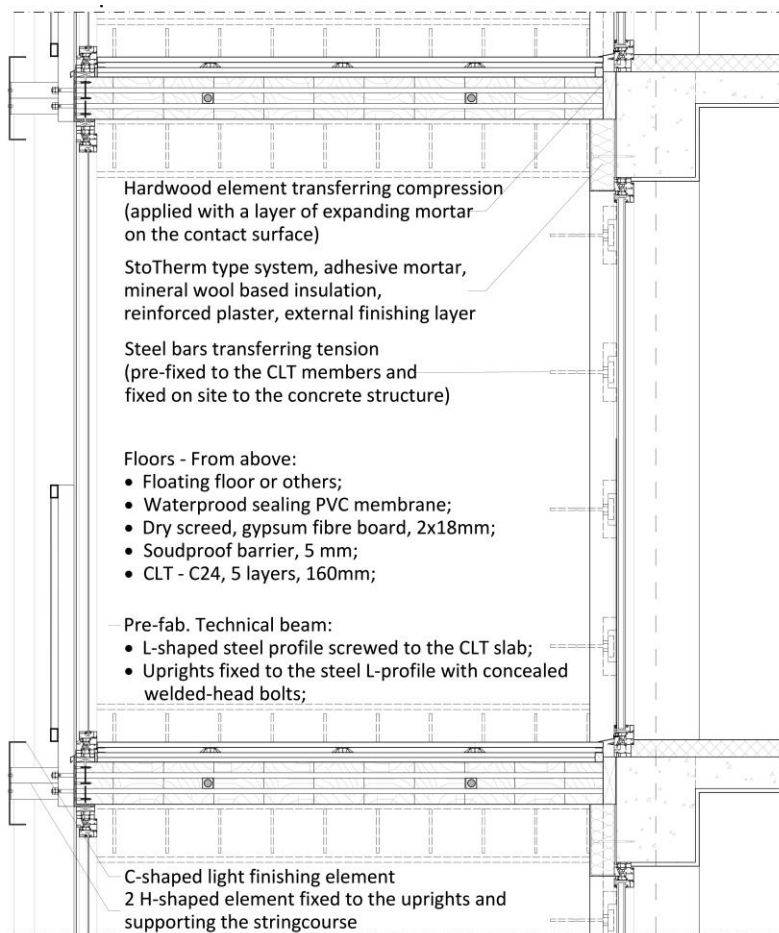

Finally, the sun-space architectural unit is presented. It is basically an intermediate solution between the previous ones, as it has the same stratification of the extra-room floor, being a watertight space thanks to the external windows; and it is also characterised by the use of the technical L-beam including uprights and supports for the stringcourse. The external windows can be occasionally completely open.

As with the balcony solution, the insulation layer is then provided on the existing façades and the same considerations can be applied to this solution.

The materials and stratigraphy are best shown in Figure 314 and the layouts in the Appendix.

Figure 314 – Vertical cross-section showing the technology provided for the sun-space solution within the CLT portals

7.2.4.4 Energy efficiency

The three architectural solutions are designed in direct collaboration with the CLT panels. For each solution, the design ensures thermal conductivity performances (U-value), suitable for a nearly zero-energy building (Table 203). Pre-assembled façade components were foreseen: the insulated wooden outer frame panel for the extra-room and the technical beam with railings, stringcourse and gutter for balcony and sun-space. In the last two cases, the new envelope is provided on the existing surface and can be easily installed by using the CLT outer structure.

Table 203 – Conductivity values associated to the external vertical partitions before (Brasov case study) and after the renovation (designed to stay below the limit value of $0.24 \text{ W/m}^2\text{K}$)

Initial state		
Walls	Positioning	U ($\text{W/m}^2\text{K}$)
External walls	Brasov case study [4]	1.39-1.84
Project state		
Walls	Positioning	U ($\text{W/m}^2\text{K}$)
Prefabricated timber-based walls	Extra-room	0.196
Insulated RC frames	Balcony and Sunspace	0.232
Insulated masonry infills	Balcony and Sunspace	0.155

8. Conclusions and further steps

8.1 Athens case study

8.1.1 Seismic assessment

In order to evaluate the strengthening intervention by means of external steel shear walls applied perpendicularly to the existing façades, different types of seismic analyses were performed, increasing their complexity and progressively reducing the safety limits of the results. It was in fact implied by the results obtained (especially looking at the initial state of the case studies) that more simplified analyses tend to give more conservative results. However, increasing the complexity of the analyses allowed to confirm the effectiveness of the exoskeleton for the seismic improvement of existing RC buildings, and highlighted specific points of interest that, if further investigated, could refine the strategy and mitigate the disruption related to the sometimes-unavoidable interventions on internal structure. With reference to the solution without roof extension (proved to be irrelevant to increase the margin of improvement) and foreseeing the hinge connection between the structures, the obtained results are herewith summarised.

The linear dynamic analyses quantified the improvement in about 45% of the design seismic action calculated at the LS SD, and it is related to the reduction of the torsional components, to a new distribution of the internal stresses, and to a reduction of seismic loads due to the increase of the behaviour factors. Moreover, the verification of the inter-storey drift evaluated at LS DL was fulfilled in the design solutions, going from a vulnerability value of 89% to 111%.

Non-linear static analyses were used to determine a series of parameters to evaluate the benefits conferred by the application of the exoskeleton (TDV, initial stiffness and C/D acceleration ratios).

Target displacement verifications (TDVs) in the initial state were verified for all limit states except for the DL in the transverse direction, where a value of 129% was reported. A weakness towards frequent earthquakes was therefore shown in accordance with the interstorey verifications for the linear dynamic analysis. Although a good inelastic behaviour of the structure was recorded, the evaluation is partially compromised, for the initial state, by the torsional behaviour that usually led to non-conservative results, related to a reduction of the participating mass in the direction of the seismic loads or to the neglect of torsional effects that may compromise the outermost elements. In the project solutions this ratio has been verified in all combinations by eliminating the influence of the torsional modes through a renewed stiffness distribution in the exoskeleton, solving the DL vulnerability (the worst D/C value in the project solutions was about 94%), but reducing the performance at LS NC due to a reduced displacement capacity of more than the demanded value and reaching D/C ratios of 119% (84% of the design seismic load at LS NC).

Considering the results of the worst-case configuration (modal), the stiffness of the structure increased from 98'990 kN/m to 119'312 kN/m (Δ_{increase} of 1.21) in the longitudinal direction and from 75'852 kN/m to 118'151 kN/m ($\Delta_{\text{inc.}}$ of 1.56) in the transverse direction for the project solution.

The C/D ratios in terms of simplified maximum collapse acceleration ($a_{g,c}$) indicated that the exoskeleton allowed to increase the collapse acceleration for all the performance levels analysed. With reference to the LS SD and considering the modal distribution of the forces (as the worst case), it is possible to notice that with the application of the external exoskeleton, an increase in $a_{g,c}$ from 74% to 81-85% occurred along the longitudinal direction and from 57% to 85-87% in the transverse direction. These results are similar and comparable to what was obtained with the linear dynamic analysis, but underestimating the inelastic capacity of the structures.

The exploitation of the exoskeleton calculated as the horizontal force taken by the exoskeleton over the total was reported to be about 30% in the longitudinal direction and about 40-50% in the transverse direction. These values make it possible to determine the percentage of cooperation between the existing and new structures and showed that the solution with hinge connections allows more horizontal forces to be taken. The greater exploitation of the exoskeleton obtained with the use of hinge connections, together with substantially similar results from the seismic analyses carried out, and the desire to transfer as less stress as possible to the existing structures, dictated the choice of the hinge connection.

On the other hand, the results of the shear-exploitation analysis showed that the failure of the strengthened solution jumped from damage limitation to near collapse LS without indicating ductile behaviour (not leading to the collapse of the structure, since the LS transition was related in these analyses to a single non-linear hinge passing the limit). This fact translates into TDV with fulfilment of the LS DL requirements at the expense of inelastic deformations in the existing members that would allow greater energy dissipation and possible improvement towards rare earthquakes, characterised by acceleration values typical of LS NC. At a first analysis, the increase in overall stiffness reduced the displacement capacity of the structure of more than the demanded value in the inelastic phases, as reported in other similar studies [52, 113, 118].

To further investigate the inelastic behaviour of the structures, non-linear dynamic analyses (NLDA) were performed before and after the application of the exoskeleton for all considered performance levels, paying particular attention to the DL and NC limit states. Seven time-history analyses were performed for each limit state in order to check the compliance with the target displacements at LS DL, as proposed in [113], and verifying the state of all non-linear hinges at SD and NC limit states, before and after the application of the exoskeleton.

As found for the linear dynamic and static non-linear analyses, a LS DL vulnerability was also found with the NLDA and resolved with the application of the exoskeleton. At LS SD, all analyses were found to be satisfied with and without the exoskeleton, while for LS NC three analyses out of seven showed unsatisfied requirements, presenting respectively 3, 6 and 2 hinges beyond the collapse prevention performance level for the initial state. The project solution with the application of the same ground motions resulted in displacements within LS DL (blue hinges), thus avoiding LS SD with seismic loads meeting the highest requirements (LS NC).

8.1.2 Preliminary design

Together with the different analyses carried out and presented in the manuscript, technical drawings of the project were prepared at a preliminary level of detail, in order to consider the structural variable (even if not fully defined) alongside the other project components with which it had to be integrated (energy and architecture). It was therefore necessary to develop the integrated components in parallel and ultimately for the continuation of the project. The defined design hypothesis had to be presented in order to proceed with the identification of design studios, contractors and suppliers for the final and executive phases of the project. The project is currently at the beginning of the execution phase.

A qualitative proposal is presented, developed by the author and based on the experience of the consortium and advisory board members [95], to obtain estimated quantities and costs for bill of quantities and other ongoing evaluations (e.g., LCA). The proposal concerns the entire steel structure of the exoskeleton, including connections between members and between existing and external structures and foundations, all associated with a proposed assembly procedure developed and presented in this document.

Finally, towards the development of the prototype, variations of the external structure were discussed and investigated by the Pro-GET-onE consortium in collaboration with the Greek engineering firm responsible for the structural design [149], and mentioned within the research in order to highlight further

issues and possible improvements to the original proposal. In this regard, additional structural surveys were essential for the specification of the executive project, which were carried out only in the final phase of this research, and better characterising the existing structural elements, foundations, and bedding soil. In addition, specific Greek legislation was applied at this stage to ensure that the verifications of the updated structural elements were fully complied with.

8.1.3 Further steps

The analysis of the executive design of the prototype partly covers the possible further steps that were identified during the research process, especially considering the implementation and expansion of the existing diaphragms and the detail of the connections between the two structures, considering the possible relative displacements affecting the elements during seismic events. It also highlighted the main drawback of the strategy. The exoskeleton, in fact, is not able to directly solve the intrinsic problems of the existing resisting elements. The internal RC slabs, as well as the RC beams of the existing structure, had to be retrofitted with FRP jacketing in order to fully comply to the current standard requirements, reducing the advantages of the application of the exoskeleton due to the fact that the intervention is no longer limited to the exterior of the building.

The general consequence of this fact is that the heterogeneity of existing buildings and their behaviour places boundaries on the applications of the exoskeleton, which must be adapted to the specific case, to be fully effective and sometimes even combined with specific intervention on the weakest elements of the structure or on the existing soft diaphragms [128]. To mitigate this variability, it is worth investigating the possibility of combining the strategy presented here with a possible reduction in seismic demand. One further step in this regard, certainly effective for the whole strategy, but not investigated due to budget and time constraints, is the implementation of dampers within the exoskeleton [61, 214]. The application of dampers as connecting elements between existing and new structures would exploit the relative displacements during strong seismic loading, implying an energy dissipation that would enhance a reduction of seismic demand, even for existing elements that would otherwise remain unverified. Similarly, dampers could also be provided within the diagonal bracing of the system, perhaps with lever arms to amplify the displacement that affects them. It is in fact known that dissipative devices require a certain level of displacements to be effective and their use must be tailored on each specific case study.

8.2 Italian case study

8.2.1 Seismic assessment

As for the Athens case study, similar parameters were compared to assess the seismic vulnerability, before and after the application of the exoskeleton on the Italian case study. For this case, a comparison was made between the materials used for the external structure, including steel and structural aluminium thanks to the input of ALIVA Srl. The results obtained with the two structures were practically aligned, showing that the strengthening provided by the exoskeleton is significant in relation to the seismic demand, considering both linear and non-linear analyses.

The masonry walls were decisive for the response of the structure, stiff along their main plan (in transverse direction), providing sufficient capacity, but limiting displacement capacity in the longitudinal direction where short bearing walls with openings represented the weakest points. For this case study, LS DL

did not represent an issue due to the stiffness of the masonry walls, while LS SD and LS NC indicated the seismic vulnerability of the structure. The linear dynamic analysis was more conservative, including the effects of torsional behaviour otherwise lost by the pushover in the same direction and stating an improvement ranging from 25% to 65% at LS SD.

On the other hand, the first vibration mode represents the most vulnerable behaviour of the existing structure since the displacements in the longitudinal direction, which are higher due to the presence of short walls, are related to the failures of the latter under the design seismic loads. The longitudinal direction represents the weakest direction for the existing building and was also considered as the most reliable among the non-static linear analyses. From these results it can be seen (for both steel and aluminium solutions) that with the application of the external exoskeleton, there is an increase in PGA from 41% to 96% of the design seismic action along the weakest direction, and from 97% to beyond 100% in the transverse direction.

Due to a different distribution of damage and displacements over the building height, higher displacements were achieved for the project state, allowing higher values of collapse-related acceleration. This was particularly true for the longitudinal direction, while in the transverse direction a similar behaviour to the Athens case study was recorded, with an increased displacement capacity at LS DL and a decrease in ultimate displacements relative to SD and NC. Linked to the reduced displacement, increased capacity and stiffness were recorded in the transverse direction.

On the basis of the results of the non-linear analyses (not the more conservative results), an assessment was made of the possible incentives available in the Italian legislative framework [156]. The retrofit by means of exoskeleton allowed to pass from class G to A, while the comparison of the graphs representing the expected mean annual loss (PAM) for the initial state and the project state allowed to graphically show the savings in terms of renovation costs related to seismic events occurring in the area where the existing structure is located.

Retrofitting existing buildings, in fact, even if it involves a considerable initial investment, protects the building from damage in case of seismic events, saves costs related to repair and replacement, maintains the existing heritage, and ensures safety for the inhabitants.

A simplified costs comparison was also made between the two solutions and combined with the preliminary LCA results obtained from the Pro-GET-onE framework. The simple cost comparison indicated the steel solution to be more economical, with a total cost of 345'738 € versus 368'921 € for the aluminium solution (without considering additional voices mentioned in previous sections, that would further increase the total costs of the aluminium solution). Together with the results presented in Section 4.4, it is shown that structural aluminium could be a valid alternative to steel for seismic strengthening, regardless of the need for further experimental investigations and updated standards for seismic zones, but it proves to be an expensive and less sustainable option, compared to a more consolidated material, such as steel, which would reduce the variables in terms of analysis and calculation and would also simplify the construction procedures. Aluminium, in fact, is locally weakened in the heat zones created by welding and is therefore less prone to adapt to customised situations. On the other hand, if carefully designed with specific tolerances and pre-assembled joints, it would be an interesting practical and lightweight alternative to be further investigated.

8.2.2 Further steps

As mentioned in Section 5.2.2, this case study was the first case evaluated for the development of the exoskeleton, and the related technological system was limited due to time constraints within the project, related to other priorities such as the development of the prototype in Athens and the subsequent wood-based solution. In order to better evaluate the seismic improvement on this case study, the possible implementations that have been shown to improve and better define the strategy are:

- the use of hinge connections;

- the distribution of stiffnesses in the exoskeleton to avoid pre-existing torsional components;
- the use of lower steel grades for diagonal bracing;
- the increase of non-linear static analyses performed, considering multiple directions and signs, and implementing adaptive pushover analyses in case of torsional behaviour;
- the use of non-linear dynamic analyses;
- and the provision of a detailed solution based on the singularities of the existing building.

In addition to this list, it is possible to confirm the considerations made in Section 8.1.3, in relation to the Athens case study.

8.3 Brasov case study

8.3.1 Seismic assessment

The contribution aims at introducing and describing a new integrated technology made out of wood engineering products (CLT panels) to ensure an energy and architectural retrofit, linked at the same time to a structural improvement. It has been shown to meet the three main requirements of Pro-GET-onE, providing an efficient and more sustainable alternative to the more established steel exoskeletons.

Different parameters were compared to assess the seismic vulnerability, before and after the application of the wooden exoskeleton on the RC-MRF case study located in Brasov. The existing structure in the initial state has a comparable behaviour in both directions, while the higher number of CLT walls applied along the longitudinal direction, with respect to the transverse direction, determined for the project state in that direction a greater increase of stiffness and strength. In addition, as a result of the reduction of the shear loads concentrated in lower storeys, an increased displacement capacity was recorded for the control point of the analysis.

As a consequence, due to a better distribution of the damage along the height of the existing structure, the q-factors resulting from the pushover analyses increased in both directions. While for the longitudinal direction the behaviour factor passed from 2.90 to 3.63, in the transverse direction the improvement, in terms of possible force reduction, was recorded from 2.67 to 2.90. The renovated distribution of damage along the height of the building allowed greater displacement capacities, dissipating more energy, and reducing the damage concentrated in the lower floors, typical of the moment-resisting frame structures.

In terms of TDV, the wood-based exoskeleton allowed to increase from 62% to 101% in the transverse direction, and from 66% to 102% in the longitudinal direction.

The stiffness of the whole system increased from 50'818 kN/m to 59'894 kN/m (Δ_{increase} of 1.18) in the longitudinal direction, and from 42'903 kN/m to 63'151 kN/m ($\Delta_{\text{inc.}}$ of 1.47) in the transverse direction for the timber-based project solution, resembling the results obtained for the steel exoskeleton on the Athens case study, but with slightly lower values. The different increase is due to a greater number of CLT walls placed along the longitudinal direction with an increase in the seismic response for the transverse direction.

The results of the analyses showed that the wood-based external structure could be comparable to a steel exoskeleton [97], meeting the design requirements associated with the performance level of SD. However, the exploitation of the external structure at the LS SD showed that the CLT walls took from 17% to 38% of the horizontal forces from the total amount, showing margins of improvement of the system that could be explored in further steps by varying the base connection system.

8.3.2 Further steps

Further analysis is needed to deepen the understanding of the dynamic behaviour of the strengthened structure due to its partially released connection with the existing RC structure and possibly implying a variation of this connection towards a stronger longitudinal cooperation. In particular, if the case study allows a perimeter extension, it is indeed possible to use the exoskeleton on all sides and combine longitudinal connectors, thus also reducing the necessary tolerances provided by the feasibility study here presented. Regarding the latter, numerical and experimental investigations must be carried out to characterise them, as well as their interaction with the existing RC elements.

A better exploitation of the corners of the timber extensions should be studied to possibly improve the structural performance and the architectural aspects, perhaps in combination with vertical connection compartments or with new HVAC systems, not developed for this feasibility study.

In order to increase the overall stiffness and participation of the wood-based exoskeleton, the insertion of post-tensioned steel cables within the CLT wall layers (vertically) could be investigated [178, 179]. Increased stiffness at the foundation interface between CLT walls and concrete foundations could be achieved by exploiting rocking mechanisms and consequently reducing the number of connectors (hold-downs and angular brackets). Alternatively, more suitable foundation connectors could be proposed (e.g., X-RAD connection system as ETA 15/0632), which have so far been deliberately kept as simple as possible to minimise variables in the numerical analyses. Further feasibility studies are required to determine the range of potential applications of the wooden exoskeleton (boundaries).

In addition, as in the previously mentioned case study, the use of dissipative devices at the level of connections with the existing structure could reduce the overall seismic demand also for the wooden variant.

8.4 PT-CLT tests

As part of the developed wood-based exoskeleton, particular attention was paid to the connection between the horizontal and vertical CLT panels. This connection was realised by adopting an existing analytical model [164, 169, 210] to represent the moment-rotation behaviour of post-tensioned connections, in this case composed of CLT panels and a steel widening plate to allow for adequate stiffness and capacity, thus avoiding grain crushing in the wood elements. To avoid repetition, reference is made to Section 6.4.2, where main conclusions and further steps, in relation to the results of the experimental campaign carried out, were summarised.

8.5 Integrated prefabricated components

Finally, the prefabricated components that compose the new envelope and create the new habitable extensions were presented in Chapter 7. Two different solutions characterising the technology of the integrated system for the external steel and timber structures were introduced. The design concerned the layering of the architectural units, considering their assembly procedures, their connections with the structural components and the integration with the technical systems (HVAC etc.), always ensuring a renewed efficient envelope. The studies carried out within the European project verified the energy performance of the different solutions applied on the case studies [99]. Considering three different scenarios: all extra-room extensions (GET 1), all sun-space extensions (GET 2) or all balcony extensions (GET 3), the

overall energy savings due to the application of Pro-GET-onE strategy have been investigated in [99] pointing out solutions GET2 and GET3 as highly advisable towards the achievement of the nZEB status.

Insights of the technology developed within Pro-GET-onE for the final implementation on the Athens case study were illustrated, highlighting advantages, disadvantages and the design phases leading to the adopted solutions. The consortium's inputs, particularly focused on sun-space, extra-room and all components related to energy retrofit, were incorporated into the main definitive design developed by the author. Different balcony solutions were designed and proposed by the author, varying materials, costs, and stratigraphy. Thanks to the collaboration with the consortium, the architectural design of the Athens prototype has been holistically defined (including technical, energy, architectural and structural aspects), resulting in prefabricated components characterised by rapid assembly procedures. The solutions described in this work formed the basis for the development of the executive design for the implementation of Pro-GET-onE.

The technological solution based on engineering wood products (CLT panels) has been shown to meet the three main requirements of the European project (safety, energy efficiency and extensions), providing an efficient and more sustainable alternative to the established steel exoskeleton. A rapid assembly procedure for the structure and technological components was presented to underline the advantages of using lightweight timber products, compared to their steel and/or concrete counterparts, and the level of prefabrication of the various elements with consequent optimisation of construction time. With the same logic, prefabricated technological architectural solutions constitute the finishing layer of the renovation, providing an energy efficient envelope and three possible spacing units.

The research presents results obtained as part of the ongoing research activity which aims at demonstrating the seismic improvement conferred by the application of strengthening exoskeletons, including the development of integrated technological systems, capable of solving simultaneously the energy and architectural deficiency of existing buildings constructed after World War II. Façade extensions are therefore intended to affect several aspects of the building's retrofit. They increase the living area and at the same time allow energy efficiency to be achieved in different configurations by reducing the thermal load required throughout the year [99]. The combination of energy and structural improvement components on the same product allows the exploitation of a prefabricated and customised solution, aiming at the creation of a paradigm in the practice of renovation of existing buildings [99].

This innovative and efficient technology could help stimulate the building sector towards an increase in retrofit interventions. The studied solutions aim at creating the conditions to generate attractive self-financing schemes to support deep renovations. In fact, Pro-GET-onE aims at a standardised solution with a replicable strategy for the Mediterranean countries (characterised by high seismicity), constituting an attractive strategy in energy and architectural renovation of existing buildings for users, policy makers and investors. It is also translatable into a further reason to mobilise investments on this sector, by virtue of an overall reduction in consumption [99].

Further steps in the development of the technological solution will result from the implementation of the prototype and the subsequent monitoring foreseen within the European project. Confirmations, specifications, and possible improvements would be identified with regard to technological solutions, assembly procedures, integration of the various aspect of the project, final costs and expected impacts of the improvement strategy through the exploitation of the know-how obtained throughout the European project. Only with direct collaboration with designers, construction companies, and suppliers it is possible to better characterise the technological solution adopted through the development of the executive design.

Building regulations and standard requirements should be carefully investigated and addressed to further exploit the strategy. These requirements constitute mandatory limits, not always surmountable, to the volumetric extensions. They should therefore drive the choice of the renovation strategy at an early stage.

Bibliography

- [1] A. Ferrante *et al.*, "A European Project for Safer and Energy Efficient Buildings: Pro-GET-onE (Proactive Synergy of inteGrated Efficient Technologies on Buildings' Envelopes)," *Sustainability*, vol. 10, no. 3, p. 812, 2018.
- [2] D. Giardini, J. Woessner, and L. Danciu, "Mapping Europe's Seismic Hazard," *EOS, Transactions American Geophysical Union*, vol. 95, 07/22 2014, doi: 10.1002/2014EO290001.
- [3] M. Pasca, "Il costruito italiano: tipologie, problematiche, interventi pre e post sisma," *Tafter Journal*, 08/01 2012.
- [4] UNIBO, ABT, TUM, and NKUA, "D2.2: Report on Structural and Seismic Retrofit Techniques and Projects," in "*Proactive synergy of inteGrated Efficient Technologies on buildings' Envelopes*," Pro-GET-onE, 2017, vol. Task 2.2 - WP2.
- [5] R. Gulli, EdicomEdizioni, Ed. *Recupero sostenibile del patrimonio costruito in ambito sismico*. Monfalcone (Gorizia): EdicomEdizioni, 2014.
- [6] Istituto Nazionale di Statistica (ISTAT). 15° Censimento generale della popolazione e delle abitazioni [Online] Available: <http://dati-censimentopopolazione.istat.it>
- [7] H. Kaplan, S. Yilmaz, H. Binici, E. Yazar, and N. Çetinkaya, "May 1, 2003 Turkey—Bingöl earthquake: damage in reinforced concrete structures," *Engineering Failure Analysis*, vol. 11, no. 3, pp. 279-291, 2004/06/01/ 2004, doi: <https://doi.org/10.1016/j.engfailanal.2003.08.005>.
- [8] B. A. Bolt, *Earthquakes*. W.H. Freeman, 1999.
- [9] Fédération internationale du béton (fib), *Seismic Assessment and Retrofit of Reinforced Concrete Buildings: State-of-the-art report*. International Federation for Structural Concrete (fib), Lausanne, Switzerland, 2003. ISSN 1562-3610.
- [10] J. Woessner *et al.*, "The 2013 European Seismic Hazard Model: key components and results," *Bulletin of Earthquake Engineering*, vol. 13, no. 12, pp. 3553-3596, 2015/12/01 2015, doi: 10.1007/s10518-015-9795-1.
- [11] European Committee of Standardization (CEN). *EN 1998-3: Eurocode 8: Design of structures for earthquake resistance - Part 3: Assessment and retrofitting of buildings*, Brussels, Belgium, 2005.
- [12] European Committee of Standardization (CEN). *EN 1998-1: Eurocode 8: Design of structures for earthquake resistance - Part 1: General rules, seismic actions and rules for buildings*, Brussels, Belgium, 2004.
- [13] D. Giardini and *et al.*, "Seismic Hazard Harmonization in Europe (SHARE): Online Data Resource," ed, 2013.
- [14] L. Pasqualini. Terremoti in Europa: ecco la pericolosità sismica nei paesi del continente europeo [Online] Available: <https://conosceregeologia.it/2016/10/11/news/terremoti-europa-la-pericolosita-sismica-nei-paesi-del-continente-europeo/>
- [15] N. van der Voort and F. Vanclay, "Social impacts of earthquakes caused by gas extraction in the Province of Groningen, The Netherlands," *Environmental Impact Assessment Review*, vol. 50, pp. 1-15, 2015/01/01/ 2015, doi: <https://doi.org/10.1016/j.eiar.2014.08.008>.
- [16] J. P. Moehle and S. A. Mahin, "Observations on the Behavior of Reinforced Concrete Buildings During Earthquakes," *ACI Symposium Publication*, vol. 127, 10/1/1991, doi: 10.14359/3007.
- [17] F. Cortesi, L. Ludovisi, and V. Mariani, Maggioli Editore. *La progettazione strutturale su edifici esistenti. Progettazioni tecniche & materiali*. Santarcangelo di Romagna, p. 266, 2018.
- [18] P. Munafò and S. Capodaglio, "La scelta delle tecniche di intervento: strutture esistenti in calcestruzzo armato (parte prima)," *Recupero e conservazione*, vol. 17, no. 97, pp. pp. 55-63, 2011.
- [19] P. Ricci, F. Luca, and G. Verderame, "6th April 2009 L'Aquila earthquake, Italy: Reinforced concrete building performance," *Bulletin of Earthquake Engineering*, vol. 9, pp. 285-305, 02/01 2011, doi: 10.1007/s10518-010-9204-8.

- [20] F. Braga, V. Manfredi, A. Masi, A. Salvatori, and M. Vona, "Performance of non-structural elements in RC buildings during the L'Aquila, 2009 earthquake," *Bulletin of Earthquake Engineering*, vol. 9, pp. 307-324, 02/01 2011, doi: 10.1007/s10518-010-9205-7.
- [21] R. Chenna and P. Ramancharla, "Damage assessment due to pounding between adjacent structures with equal and unequal heights," *Journal of Civil Structural Health Monitoring*, vol. 8, 09/01 2018, doi: 10.1007/s13349-018-0296-1.
- [22] A. Yakut, P. Gülkan, B. Sadık Bakır, and M. Tolga Yılmaz, "Re-examination of damage distribution in Adapazarı: Structural considerations," *Engineering Structures*, vol. 27, no. 7, pp. 990-1001, 2005/06/01/ 2005, doi: <https://doi.org/10.1016/j.engstruct.2005.02.001>.
- [23] P. Munafò and S. Capodaglio, "La scelta delle tecniche di intervento: strutture esistenti in calcestruzzo armato (parte seconda)," *Recupero e conservazione*, vol. 17, no. 98/99, pp. 72-79, 2011.
- [24] J. Moehle, "State of Research on Seismic Retrofit of Concrete Building Structures in the US," 2001.
- [25] Y. Higashi, T. Endo, and Y. Shimuzu, "Experimental studies on retrofitting of reinforced concrete building frames," presented at the Proc. of the eight world conference on earthquake engineering, 1984.
- [26] G. Necevaska-Cvetanovska and A. Rosh, "Rehabilitation of RC buildings in seismically active regions using traditional and innovative materials," *Gradjevinski materijali i konstrukcije*, vol. 62, pp. 19-30, 01/01 2019, doi: 10.5937/GRMK1903019N.
- [27] G. Tsionis, R. Apostolska, and F. Taucer, "Seismic strengthening of RC buildings," JRC Science Hub, European Union report, Luxembourg: Publications Office of the European Union, 2014.
- [28] Dolmen SRL, restoration degraded RC column. "Dolmen SRL Home page." <http://www.dolmensrl.org> (accessed 15 October 2020).
- [29] Studio MaPi - Architettura & Ingegneria. "Portfolio dei lavori pubblici." <http://www.studiomapi.it/portfolio-singolo.php?id=14> (accessed 14 October 2020).
- [30] Edilcam Sistemi. "Realizzazioni." 2018. <https://www.edilcamsistemi.com/realizzazioni-i-t-c-c-rosa> (accessed 14 October 2020).
- [31] Dolmen SRL, FRP strengthening applications. "Dolmen SRL Home page." <http://www.dolmensrl.org> (accessed 14 October 2020).
- [32] A. Borri, G. Castori, A. Grazini, and A. Giannantoni, "Compositi SRP/SRG: caratteristiche, sperimentazione e applicazioni," *Costruire in laterizio*, vol. XX, no. 117, p. 6, 2007.
- [33] M. Zelin, "Microstructure evolution in pearlitic steels during wire drawing," *Acta Materialia*, vol. 50, no. 17, pp. 4431-4447, 2002/10/09/ 2002, doi: [https://doi.org/10.1016/S1359-6454\(02\)00281-1](https://doi.org/10.1016/S1359-6454(02)00281-1).
- [34] H. Kaplan and S. Yılmaz, "Seismic Strengthening of Reinforced Concrete Buildings," 2012, doi: 10.5772/28854.
- [35] R. Kumar, Y. Singh, and R. Deoliya, *Review of Retrofitting Techniques for Masonry Infilled RC Frame Buildings*. 2009.
- [36] D. Prati, L. Badini, G. Mochi, S. Castellaro, and A. Ferrante, "Passive single-station techniques applied for dynamic characterization of reinforced concrete buildings," *TEMA*, vol. 6, 1, p. 11, 2020, doi: <http://dx.doi.org/10.30682/tema0601b>.
- [37] H.-S. Lee and W. Sung-Woo, "Effect of masonry infills on seismic performance of a 3-storey R/C frame with Non-seismic detailing," *Earthquake Engineering & Structural Dynamics*, vol. 31, pp. 353-378, 02/01 2002, doi: 10.1002/eqe.112.
- [38] S. Pujol, A. Benavent-Climent, M. Rodriguez, and J. Smith-Pardo, "Masonry infill walls: an effective alternative for seismic strengthening of low-rise reinforced concrete building structures," 01/01 2008.
- [39] R. Figueiro, F. E. M. Cunha, G. Vasconcelos, and S. Abreu, "A brief overview on the retrofitting possibilities of masonry infill walls," 2011.
- [40] E. Yuksel *et al.*, "Performance of alternative CFRP retrofitting schemes used in infilled RC frames," *Construction and Building Materials*, vol. 24, no. 4, pp. 596-609, 2010/04/01/ 2010, doi: <https://doi.org/10.1016/j.conbuildmat.2009.09.005>.

- [41] E. Yuksel, A. Ilki, G. Erol, C. Demir, and H. Karadogan, "Seismic retrofit of infilled reinforced concrete frames with CFRP composites," *Advances in Earthquake Engineering for Urban Risk Reduction*, vol. 66, 2005, pp. 285-300, doi: 10.1007/1-4020-4571-9_19.
- [42] R. J. Frosch, W. Li, M. E. Kreger, and J. O. Jirsa, "Seismic strengthening of a nonductile RC frame using precast infill panels," presented at the Eleventh World Conference on Earthquake Engineering, Elsevier Science Ltd, Acapulco, Mexico, 1996, 1404. [Online]. Available: http://www.iitk.ac.in/nicee/wcee/article/11_1404.PDF.
- [43] E. Kurt, "Investigation of strengthening techniques using pseudo-dynamic testing," 01/01 2010.
- [44] T. Tankut, D. Okuyucu, M. Susoy, and M. Baran, "Seismic strengthening of reinforced concrete frames by precast concrete panels," *Magazine of Concrete Research*, vol. 63, pp. 321-332, 05/01 2011, doi: 10.1680/macr.10.00030.
- [45] F. Karadogan *et al.*, "Improved Infill Walls and Rehabilitation of Existing Low-Rise Buildings," in *Seismic Risk Assessment and Retrofitting: With Special Emphasis on Existing Low Rise Structures*, A. Ilki, F. Karadogan, S. Pala, and E. Yuksel Eds. Dordrecht: Springer Netherlands, 2009, pp. 387-426.
- [46] M. Y. Kaltakci, M. H. Arslan, U. S. Yilmaz, and H. D. Arslan, "A new approach on the strengthening of primary school buildings in Turkey: An application of external shear wall," *Building and Environment*, vol. 43, no. 6, pp. 983-990, 2008/06/01/ 2008, doi: <https://doi.org/10.1016/j.buildenv.2007.02.009>.
- [47] H. Kaplan, S. Yilmaz, N. Cetinkaya, and E. Atimtay, "Seismic strengthening of RC structures with exterior shear walls," *Sadhana*, vol. 36, no. 1, p. 17, 2011/04/20 2011, doi: 10.1007/s12046-011-0002-z.
- [48] W. Y. Kam and S. Pampanin, "The seismic performance of RC buildings in the 22 February 2011 Christchurch earthquake," *Structural Concrete*, vol. 12, no. 4, pp. 223-233, 2011, doi: 10.1002/suco.201100044.
- [49] M. G. Ireland, S. Pampanin, and D. K. Bull, "Experimental Investigations of a Selective Weakening Approach for the Seismic Retrofit of R.C. Walls," 01/01 2007.
- [50] M. Badoux and J. O. Jirsa, "Steel Bracing of RC Frames for Seismic Retrofitting," *Journal of Structural Engineering*, vol. 116, no. 1, pp. 55-74, 1990, doi:10.1061/(ASCE)0733-9445(1990)116:1(55).
- [51] G. E. Thermou and A. S. Elnashai, "Seismic retrofit schemes for RC structures and local-global consequences," *Progress in Structural Engineering and Materials*, vol. 8, no. 1, pp. 1-15, 2006, doi: 10.1002/pse.208.
- [52] M. R. Maheri, R. Kousari, and M. Razazan, "Pushover tests on steel X-braced and knee-braced RC frames," *Engineering Structures*, vol. 25, no. 13, pp. 1697-1705, 2003/11/01/ 2003, doi: [https://doi.org/10.1016/S0141-0296\(03\)00150-0](https://doi.org/10.1016/S0141-0296(03)00150-0).
- [53] H. El-Sokkary and K. Galal, "Analytical investigation of the seismic performance of RC frames rehabilitated using different rehabilitation techniques," *Engineering Structures*, vol. 31, no. 9, pp. 1955-1966, 2009/09/01/ 2009, doi: <https://doi.org/10.1016/j.engstruct.2009.02.048>.
- [54] T. Görgülü, Y. S. Tama, S. Yilmaz, H. Kaplan, and Z. Ay, "Strengthening of reinforced concrete structures with external steel shear walls," *Journal of Constructional Steel Research*, vol. 70, pp. 226-235, 2012/03/01/ 2012, doi: <https://doi.org/10.1016/j.jcsr.2011.08.010>.
- [55] F. Liu, L. Wang, and X. Lu, "Experimental investigations of seismic performance of un-retrofitted and retrofitted RC frames," *15th World Conference of Earthquake Engineering*, vol. 1, p. 7, 2012.
- [56] A. Ghobarah and H. Abou Elfath, "Rehabilitation of a reinforced concrete frame using eccentric steel bracing," *Engineering Structures*, vol. 23, no. 7, pp. 745-755, 2001/07/01/ 2001, doi: [https://doi.org/10.1016/S0141-0296\(00\)00100-0](https://doi.org/10.1016/S0141-0296(00)00100-0).
- [57] C. Durucan and M. Dicleli, "Analytical study on seismic retrofitting of reinforced concrete buildings using steel braces with shear link," *Engineering Structures*, vol. 32, no. 10, pp. 2995-3010, 2010/10/01/ 2010, doi: <https://doi.org/10.1016/j.engstruct.2010.05.019>.
- [58] M. D'Aniello, G. Della Corte, and F. Mazzolani, *Seismic Upgrading of RC Buildings by Buckling Restrained Braces: Experimental Results vs. Numerical Modeling*. 2006.

- [59] C. Mahrenholtz *et al.*, "Retrofit of reinforced concrete frames with buckling-restrained braces," *Earthquake Engineering & Structural Dynamics*, vol. 44, 01/01 2015, doi: 10.1002/eqe.2458.
- [60] A. Martelli, "La protezione degli edifici dal terremoto mediante moderne tecnologie," ADEPRON, 2012. [Online]. Available: http://www.ingegneriastrutturale.net/documenti/articoli/adepron04_0021.pdf
- [61] H. Özkaynak, "Earthquake behavior of steel cushion-implemented reinforced concrete frames," *Earthquake Engineering and Engineering Vibration*, vol. 17, no. 2, pp. 385-401, 2018/04/01 2018, doi: 10.1007/s11803-018-0448-7.
- [62] T. Trombetti and S. Silvestri, "Novel schemes for inserting seismic dampers in shear-type systems based upon the mass proportional component of the Rayleigh damping matrix," *Journal of Sound and Vibration*, vol. 302, no. 3, pp. 486-526, 2007/05/08/ 2007, doi: <https://doi.org/10.1016/j.jsv.2006.11.030>.
- [63] L. Dezi, F. Gara, L. Gioiella, and A. Balducci, "An innovative seismic protection system for existing buildings: External Dissipative Towers," 2016.
- [64] D. Ravizza, "Nuove tecnologie antisismiche," *Recuperare l'edilizia*, vol. 8, no. 39, p. 4, 2004.
- [65] *FEMA 547. Techniques for the seismic rehabilitation of existing buildings*, F. E. M. A. (FEMA), Washington D.C., USA, 2006.
- [66] İ. E. Bal, H. Crowley, R. Pinho, and F. G. Gülay, "Detailed assessment of structural characteristics of Turkish RC building stock for loss assessment models," *Soil Dynamics and Earthquake Engineering*, vol. 28, no. 10, pp. 914-932, 2008/10/01/ 2008, doi: <https://doi.org/10.1016/j.soildyn.2007.10.005>.
- [67] Federal Emergency Management Agency (FEMA), "HAZUS-MH technical manual," Washington, DC, USA, 2003.
- [68] Ordinanza del presidente del consiglio dei ministri (OPCM) n. 3274 20/03/2003: *Primi elementi in materia di criteri generali per la classificazione sismica del territorio nazionale e di normative tecniche per le costruzioni in zona sismica*, Rome, 20 March 2003.
- [69] Hellenic Statistical Authority. 2011 Population and housing census, Characteristics and amenities of dwellings, ELSTAT 2011
- [70] Hellenic Statistical Authority. 2011 Population and housing census, Amenities and Dwelling/Households, ELSTAT 2011
- [71] Hellenic Statistical Authority. 2011 Building Census, ELSTAT 2011 [Online] Available: <http://www.statistics.gr/en/census-buildings-2011>
- [72] National Institute of Statistic. Residential buildings by type construction material of outer, NIS [Online] Available: <http://www.recensamantromania.ro/>
- [73] StatLine Statistics Netherlands. Construction and housing, CBS 2012 [Online] Available: <http://statline.cbs.nl/statweb/>
- [74] IEE Program TABULA. Statistics of the Dutch Building Stock - Statistic S-1.1: Frequency of Building Types of the National Building Stock [Online] Available: <http://episcopo.eu/index.php?id=239>
- [75] B. Spaan, Waag Society, and inspired by BKLYNR. Map and other building data in the Netherlands [Online] Available: <http://code.waag.org/buildings/>
- [76] Instituto Nacional de Estadística. Construction and housing, INE 2001 [Online] Available: <http://www.ine.es/>
- [77] Valencian Institute of Building. Use of Building Typologies for Energy Performance Assessment of National Building Stock, Existent Experiences in Spain [Online] Available: <http://www.five.es/inicio/579-tabula.html>
- [78] A. Ferrante, M. Bruno, Ed. *AAA Adeguamento, adattabilità, architettura. Teorie e metodi per la riqualificazione architettonica, energetica ed ambientale del patrimonio edilizio esistente* (Edilizia illustrata). Milano: Gottardo Marcoli, 2013, pp. VIII-238 p.,ill. , Brossura.
- [79] H. S. Brown and P. J. Vergragt, "Bounded socio-technical experiments as agents of systemic change: The case of a zero-energy residential building," *Technological Forecasting and Social Change*, vol. 75, no. 1, pp. 107-130, 2008/01/01/ 2008, doi: <https://doi.org/10.1016/j.techfore.2006.05.014>.

- [80] R. W. Bliss, *Design and performance of the nation's only fully solar-heated house, Air conditioning, Heating and Ventilating*. 1955.
- [81] T. V. Esbensen and V. Korsgaard, "Dimensioning of the solar heating system in the zero energy house in Denmark," *Solar Energy*, vol. 19, no. 2, pp. 195-199, 1977/01/01/ 1977, doi: [https://doi.org/10.1016/0038-092X\(77\)90058-5](https://doi.org/10.1016/0038-092X(77)90058-5).
- [82] M. J. Bürer and R. Wüstenhagen, "Which renewable energy policy is a venture capitalist's best friend? Empirical evidence from a survey of international cleantech investors," *Energy Policy*, vol. 37, no. 12, pp. 4997-5006, 2009/12/01/ 2009, doi: <https://doi.org/10.1016/j.enpol.2009.06.071>.
- [83] H. Bulkeley, "Cities and the Governing of Climate Change," *Annual Review of Environment and Resources*, vol. 35, no. 1, pp. 229-253, 2010/11/21 2010, doi: 10.1146/annurev-environ-072809-101747.
- [84] A. Meyer, "A Copenhagen Climate Treaty," Karlsruhe, 2010.
- [85] F. Lattke, K. Larsen, S. Ott, and Y. Cronhjort, *TES Energy Facade – prefabricated timber based building system for improving the energy efficiency of the building envelope*, funded by: Woodwisdom Net, Research project from 2008-2009. 2011.
- [86] G. Masera, "Le tecnologie S/R per il recupero edilizio," *Recuperare L'Edilizia*, no. 39, pp. 30-35, 2004.
- [87] EU Horizon 2020 project "MORE-CONNECT." (accessed 13/07/2021).
- [88] S. Ott and M. Krechel, "Construction principles of seismic and energy renovation systems for existing buildings," *TEMA*, vol. 4, no. Special Issue, 3, p. 15, 2018, doi: <https://doi.org/10.17410/tema.v4i3.205>.
- [89] P. Pihelo, T. Kalamees, and K. Kuusk, "nZEB Renovation with Prefabricated Modular Panels," *Energy Procedia*, vol. 132, pp. 1006-1011, 2017/10/01/ 2017, doi: <https://doi.org/10.1016/j.egypro.2017.09.708>.
- [90] M. Calzolari. (2010) Riqualficazione energetica nell'edilizia storica, uno studio interdisciplinare per la rifunzionalizzazione di Sant'Antonio in Polesine a Ferrara. *Recupero e conservazione*. 9.
- [91] EU Horizon 2020 project "ABRACADABRA". www.abracadabra-project.eu (accessed 14/07/2021).
- [92] A. Ferrante, "Increasing the quality and the value of existing buildings: energy, seismic and architectural retrofit practices," in *2nd International Conference*, Bologna, Italy, 22 May 2019.
- [93] K. Tichelmann, "The Reality and Potential of Vertical Extensions," in *Presentation at the European Parliament - Gypsum Forum*, ed. Brussels, 2017.
- [94] A. Lacaton and J.-P. Vassal. "Lacaton & Vassal - Projects." <https://www.lacatonvassal.com> (accessed 14/07/2021).
- [95] EU Horizon 2020 project. "Pro-GET-onE." <https://www.progetone.eu> (accessed 14/07/2021).
- [96] A. Fotopoulou, L. Badini, G. Mochi, G. Predari, R. Roijackers, and R. Cojocar, "Seismic strengthening through external exoskeleton," *TEMA*, vol. 4, no. Special Issue, 3, p. 18, 2018, doi: <https://doi.org/10.17410/tema.v4i3.203>.
- [97] L. Badini, C. A. De Stefano, A. Custodi, G. Predari, and A. Ferrante, "Seismic Strengthening of Existing RC Structure Through External 3D Exoskeleton," in *IABSE Congress, New York City, 2019*, New York, IABSE, Ed., 2019, vol. 114, pp. 1018-1024, doi: 10.1080/10168664.2019.1599209. [Online]. Available: <http://toc.proceedings.com/50967webtoc.pdf>[Online].
- [98] L. Badini, S. Ott, P. Aondio, and S. Winter, "A new integrated approach on the seismic strengthening of existing RC buildings with external cross-laminated timber panels," presented at the WCTE 2021, World Conference on Timber Engineering, Santiago, Chile, 9 - 12 August, 2021.
- [99] A. Fotopoulou *et al.*, "An integrated system for façade additions combining safe, energy efficient and userorientated solutions" *TEMA*, vol. 5, no. 1, 1, p. 10, 2019, doi: <https://doi.org/10.17410/tema.v5i1.216>.
- [100] M.-N. Assimakopoulos, R. F. De Masi, D. Papadaki, S. Ruggiero, and G. P. Vanoli, "Energy audit and performance optimization of a residential university building in heating dominated climates of Italian backcountry" *TEMA*, vol. 4, no. Special Issue, 3, p. 15, 2018, doi: <https://doi.org/10.17410/tema.v4i3.202>.

- [101] A. Ferrante *et al.*, "IEQ and energy improvement of existing buildings by prefabricated facade additions: the case of a student house in Athens," September 01, 2019 2019, vol. 609, p. 042047, doi: 10.1088/1757-899x/609/4/042047. [Online]. Available: <https://ui.adsabs.harvard.edu/abs/2019MS&E..609d2047F>
- [102] N. Barmparesos, D. Papadaki, M. Karalis, K. Fameliari, and M. N. Assimakopoulos, "In Situ Measurements of Energy Consumption and Indoor Environmental Quality of a Pre-Retrofitted Student Dormitory in Athens," *Energies*, vol. 12, no. 11, p. 2210, 2019.
- [103] A. Ferrante *et al.*, "IEQ and energy improvement of existing buildings by prefabricated facade additions: the case of a student house in Athens," in *IOP Conf. Ser.: Mater. Sci. Eng.*, September 01, 2019 2019, vol. 609, p. 042047, doi: 10.1088/1757-899x/609/4/042047. [Online]. Available: <https://ui.adsabs.harvard.edu/abs/2019MS&E..609d2047F>
- [104] L. Guardigli, M. A. Bragadin, A. Ferrante, and R. Gulli, "Life cycle analysis and planning in the renovation process of public housing " *TEMA*, vol. 5, no. 2, 2, p. 14, 2019, doi: <https://doi.org/10.17410/tema.v5i2.232>.
- [105] L. Guardigli, C. Ferrer, C. Peters, A. Fotopoulou, M. A. Bragadin, and A. Ferrante, "Rehabilitation of public housing buildings in a life cycle perspective," July 01, 2019 2019, vol. 296, p. 012038, doi: 10.1088/1755-1315/296/1/012038. [Online]. Available: <https://ui.adsabs.harvard.edu/abs/2019E&ES..296a2038G>
- [106] M. Y. Kaltakci, M. H. Arslan, and U. S. Yilmaz, "Experimental and Analytical Analysis of RC Frames Strengthened Using RC External Shear Walls," *Arabian Journal for Science and Engineering*, vol. 36, no. 5, p. 721, 2011/07/22 2011, doi: 10.1007/s13369-011-0074-4.
- [107] M. Badoux and J. Jirsa, "Steel Bracing of RC Frames for Seismic Retrofitting," *Journal of Structural Engineering-asce - J STRUCT ENG-ASCE*, vol. 116, 01/01 1990, doi: 10.1061/(ASCE)0733-9445(1990)116:1(55).
- [108] T. D. Bush, E. A. Jones, and J. O. Jirsa, "Behavior of RC Frame Strengthened Using Structural Steel Bracing," *Journal of Structural Engineering*, vol. 117, no. 4, pp. 1115-1126, 1991/04/01 1991, doi: 10.1061/(ASCE)0733-9445(1991)117:4(1115).
- [109] M. Franceschini, P. Semproli, and A. Secci. (2014) I segni della ricostruzione post terremoto maggio 2012: l'adeguamento sismico della palazzina uffici nello stabilimento Magneti Marelli di Crevalcore. *Inarcos, Ingegneri Architetti Costruttori*. 9. Available: <http://www.teleios-ing.it/UserFiles/File/FRANCESCHINI/Articolo-Inarcos738 Ricostruzione%20terremoto%202012 Franceschini-Semproli-Secci.pdf>.
- [110] Ministero delle infrastrutture e dei trasporti. D.M. 14/01/2008. *Norme tecniche per le costruzioni*, Gazzetta Ufficiale della Repubblica Italiana, 2008.
- [111] I. Avarmidis, E. Mistakidis, and K. Morfidis, "Seismic Strengthening of the Building of the Rural and Surveying Engineering Department of A.U.TH. Through External Steel Structure," ed.
- [112] Organization for earthquake resistant planning and protection. Ministry of environment planning and public works. *Greek code for Seismic Resistant Structures – EAK2000*, Greece (OASP), 2000.
- [113] F. Feroldi *et al.*, "Miglioramento e adeguamento sismico di edifici contemporanei mediante approccio integrato energetico, architettonico e strutturale con soluzioni a doppio involucro a minimo impatto ambientale," *PROGETTAZIONE SISMICA*, vol. 5, pp. 31-47, 01/01 2014, doi: 10.7414/PS.5.2.31-47.
- [114] U. Dangel, "'Tall Wood Buildings: Design, Construction, and Performance" by Michael Green and Jim Taggart," *Technology/Architecture + Design*, vol. 2, no. 2, pp. 254-256, 2018/07/03 2018, doi: 10.1080/24751448.2018.1497379.
- [115] B. Dujic, T. Assistant, and R. Zarnić, "Shear Capacity of Cross-Laminated Wooden Walls," 03/09 2008.
- [116] I. Sustersic, B. Dujic, and S. Gostič, "Timber upgrade of structures on seismically active areas". 2010.
- [117] V. Hristovski, B. Dujic, N. Naumovski, and M. Garevski, "Shaking-table tests and comparative numerical investigation of various upgrade systems on existing rc structures". 2018.
- [118] I. Sustersic and B. Dujic, "Seismic strengthening of existing buildings with cross laminated timber panels," presented at the World Conference on Timber Engineering 2012, WCTE 2012, 2012.

- [119] I. Sustersic and B. Dujic, "Seismic strengthening of existing URM and RC structures using Xlam timber panels". 2013.
- [120] I. Sustersic and B. Dujic, "Seismic Strengthening of Existing Concrete and Masonry Buildings with Crosslam Timber Panels," Dordrecht, 2014: Springer Netherlands, in *Materials and Joints in Timber Structures*, pp. 713-723.
- [121] I. Sustersic and B. Dujic, "Seismic shaking table testing of a reinforced concrete frame with masonry infill strengthened with cross laminated timber panels". 2014.
- [122] T. D. Mora, A. Righi, F. Peron, and P. Romagnoni, "Functional, Energy and Seismic Retrofitting in Existing Building: An Innovative System Based on xlam Technology," *Energy Procedia*, vol. 82, pp. 486-492, 2015/12/01/ 2015, doi: <https://doi.org/10.1016/j.egypro.2015.11.851>.
- [123] F. Stazi, M. Serpilli, G. Maracchini, and A. Pavone, "An experimental and numerical study on CLT panels used as infill shear walls for RC buildings retrofit," *Construction and Building Materials*, vol. 211, pp. 605-616, 2019/06/30/ 2019, doi: <https://doi.org/10.1016/j.conbuildmat.2019.03.196>.
- [124] G. Margani, G. Evola, C. Tardo, and E. M. Marino, "Energy, Seismic, and Architectural Renovation of RC Framed Buildings with Prefabricated Timber Panels," *Sustainability*, vol. 12, no. 12, p. 4845, 2020.
- [125] F. Mazzolani, "Structural Applications of Aluminium in Civil Engineering," *Structural Engineering International*, vol. 16, pp. 280 - 285, 2006.
- [126] European Committee of Standardization (CEN). *EN 1999-1-1: Eurocode 9: Design of aluminum structures – Part 1-1: General structural rules*, Brussels, Belgium, 2007.
- [127] LIMA, NKUA, UNIBO, and TUM, "D3.3: Report on LCA," in "*Proactive synergy of integrated Efficient Technologies on buildings' Envelopes*," Pro-GET-onE, 2018, vol. Task 3.3 - WP3.
- [128] P. Foraboschi, "Miglioramento sismico di edifici esistenti mediante esoscheletri," in *Presentation at the Bologna engineers' association*, ed. Bologna: Ordine degli Ingegneri di Bologna, 2018.
- [129] CSI, "SAP2000 Ultimate v21.2.0," Structural Analysis Program, ed. Berkeley (CA, USA): Computer & Structures Inc., 2019.
- [130] CSI, "ETABS Ultimate v17.0.1," Integrated Building Design Software, ed. Berkeley (CA, USA): Computers & Structures Inc, 2018.
- [131] European Committee of Standardization (CEN). *EN 1993-1-1 Eurocode 3: Design of steel structures - Part 1-1: General rules and rules for buildings*, Brussels, Belgium, 2005.
- [132] European Committee of Standardization (CEN). *EN 1995-1-1: Eurocode 5: Design of timber structures - Part 1-1: General - Common rules and rules for buildings*, Brussels, Belgium, 2004.
- [133] European Committee of Standardization (CEN). *EN 1992-1-1: Eurocode 2: Design of concrete structures - Part 1-1: General rules and rules for buildings*, Brussels, Belgium, 2004.
- [134] European Committee of Standardization (CEN). *EN 1991-1-3: Eurocode 1: Actions on structures - Part 1-3: General actions - Snow loads*, Brussels, Belgium, 2003.
- [135] European Committee of Standardization (CEN). *EN 1991-1-1: Eurocode 1: Actions on structures - Part 1-1: General actions - Densities, self-weight, imposed loads for buildings*, Brussels, Belgium, 2002.
- [136] European Committee of Standardization (CEN). *EN 1990: Eurocode: Basis of structural design*, Brussels, Belgium, 2002.
- [137] Ministero delle infrastrutture e dei trasporti. Circolare 21/01/2019, n.7 C.S.LL.PP. *Istruzioni per l'applicazione dell'«Aggiornamento delle "Norme tecniche per le costruzioni"» di cui al decreto ministeriale 17 gennaio 2018*, Gazzetta Ufficiale della Repubblica Italiana. Rome, Italy, 2019.
- [138] Ministero delle infrastrutture e dei trasporti. D.M. 17/01/2018. *Norme tecniche per le costruzioni*, Gazzetta Ufficiale della Repubblica Italiana. Rome, Italy, 2018.
- [139] Team for development of code of interventions on reinforced concrete buildings harmonization team of code of interventions to Eurocodes. *Code of Interventions (KAN.EPE.) Final Harmonized Text*, 2013.
- [140] Google. "Google Maps." maps.google.com (accessed 27 July 2021).
- [141] NKUA, ABT, and UNIBO, "D2.6: Sheets on technical data on the case studies," in "*Proactive synergy of integrated Efficient Technologies on buildings' Envelopes*," Pro-GET-onE, 2018, vol. Task 2.6 - WP2.

- [142] F. Mengarelli, "Utilizzo del Building Information Modeling (BIM) in un caso di studio nell'ambito del Progetto EU H2020 Pro-GET-onE," Single Cycle Degree/Combined Bachelor and Master in Architecture and Building Engineering Master Thesis, Department of Architecture, Alma Mater Studiorum - University of Bologna, Bologna, 2018.
- [143] Ziss Constructions - AFOI ZISSIMOPOULOI S.A., "Technical tests, inspection of load-bearing structure of building B-FEPA at the University Campus of Zografou - Results evaluation technical report (translated title)," Structural survey provided by the National and Kapodistrian University of Athens, 2018.
- [144] American Society of Civil Engineers, *ASCE/SEI 41-17: Seismic Evaluation and Retrofit of Existing Buildings* (ASCE/SEI 41-17). 2017, doi:10.1061/9780784414859.
- [145] CSI - Computers & Structures, Inc., *SAP2000 - Integrated Solution for Structural Analysis and Design: CSI Analysis Reference Manual*. Berkeley, California, USA: Computers & Structures, Inc., 2016.
- [146] American Society of Civil Engineers (ASCE) and Federal Emergency Management Agency (FEMA). *FEMA 356: Prestandard and commentary for the seismic rehabilitation of buildings*, Washington, D.C., 2000.
- [147] Regione Marche, Italy, "Allegato A - Prezziario ufficiale 2018 della Regione Marche in materia di lavori pubblici e di sicurezza e salute nei cantieri temporanei e mobili," in *DGR n. 1616, 27/12/2016*, ed, 2018.
- [148] *SIMQKE-1 (SIMulation of earthQuAKE ground motions)*. [Online]. Available: <https://nisee.berkeley.edu/elibrary/getpkg?id=SIMQKE1>
- [149] OMITEM SA CONSULTING ENGINEERS, "Executive design of the structural retrofit of the building B-Building FEPA in Athens," Eng. Grossomanides Vasiliou, 2021.
- [150] Ordinanza del presidente del consiglio dei ministri. OPCM n. 3519 28/04/2006, *All.1b*, Rome, Italy, 28 April 2006.
- [151] Technical reports supplied by ACER Reggio Emilia, Azienda Casa Emilia-Romagna.
- [152] H. B. Kaushik, D. C. Rai, and S. K. Jain, "Stress-Strain Characteristics of Clay Brick Masonry under Uniaxial Compression," *Journal of Materials in Civil Engineering*, vol. 19, no. 9, pp. 728-739, 2007, doi:doi:10.1061/(ASCE)0899-1561(2007)19:9(728).
- [153] G. Rizzano, R. Sabatino, and G. Torello, *Un nuovo modello a telaio equivalente per l'analisi statica non lineare di pareti in muratura*. 2011.
- [154] Ordinanza del presidente del consiglio dei ministri. OPCM n. 3273 20/03/2003, *All.2 - Norme tecniche per il progetto. La valutazione e l'adeguamento sismico degli edifici*, Rome, Italy, 20 March 2003.
- [155] Consiglio nazionale delle ricerche (CNR) - Commissione di studio per la predisposizione e l'analisi di norme tecniche relative alle costruzioni. CNR-DT 208/2011, *Istruzioni per la Progettazione, l'Esecuzione ed il Controllo di Strutture di Alluminio*, 2011.
- [156] Ministero delle infrastrutture e dei trasporti. D.M. 24 del 09/01/2020, *Allegato A - Linee guida per la classificazione del rischio sismico delle costruzioni*, 2020.
- [157] Maslaev Consulting, "Technical Assessment Report - Civil engineering works regarding the change of destination from dormitory to community housing: Str. Zizinului no. 126C, Brasov, Romania," in "Civil engineering works regarding the change of destination from dormitory to community housing," Brasov, Romania, 2015.
- [158] Prevederi de proiectare pentru cl. ă. diri. P100-1/2013, *Cod de Proiectare Seismic ă*, Romania, 2013.
- [159] M. S. Froli, "Analysis of the expansion of a building using a modular system in CLT panels. Evaluation of the architectural variability and environmental impact of the modules," Single Cycle Degree/Combined Bachelor and Master in Architecture and Building Engineering, Department of Architecture, University of Pisa, Pisa, 2021.
- [160] A. A. Botici, V. Ungureanu, A. Ciutio, and D. Dubio "SUSTAINABLE RETROFITTING OF LARGE PANEL PREFABRICATED CONCRETE RESIDENTIAL BUILDINGS," 2013.
- [161] P. Aondio, P. Glaser, H. Kreuzinger, and P. G. P. Aondio, H. Kreuzinger, "FE-Berechnung von geklebtem Brettsperrholz - Teil 1: Theorie," *Bauingenieur*, vol. 95, no. 1, VDI Fachmedien, p. 4, 2020.

- [162] G. Jeitler, M. Augustin, and G. Schickhofer, "BIRCH GLT&CLT: Mechanical properties of glued laminated TIMBER and cross laminated TIMBER produced with the wood species birch," in *WCTE 2016 - World Conference on Timber Engineering*, 2016. [Online]. Available: <https://www.scopus.com/inward/record.uri?eid=2-s2.0-85010988969&partnerID=40&md5=5e5cd4c37f82d4255179e6d5f6a5f1c2>
- [163] European Committee of Standardization (CEN). *EN 338:2016: Structural timber - Strength classes*, Brussels, Belgium, 2016.
- [164] F. Wanninger and A. Frangi, "Experimental and analytical analysis of a post-tensioned timber connection under gravity loads," *Engineering Structures*, vol. 70, pp. 117–129, 07/01 2014, doi: 10.1016/j.engstruct.2014.03.042.
- [165] F. Wanninger and A. Frangi, "Experimental and analytical analysis of a post-tensioned timber frame under horizontal loads," *Engineering Structures*, vol. 113, pp. 16–25, 04/01 2016, doi: 10.1016/j.engstruct.2016.01.029.
- [166] M. Priestley, S. Sritharan, J. Conley, and S. Pampanin, "Preliminary Results and Conclusions from the PRESSS Five-Story Precast Concrete Test Building," *PCI Journal*, vol. 44, 11/01 1999, doi: 10.15554/pcij.11011999.42.67.
- [167] A. Palermo, S. Pampanin, A. H. Buchanan, and M. P. Newcombe, "Seismic Design of multi-storey buildings using laminated veneer lumber (LVL)," 01/01 2005.
- [168] G. Granello, A. Palermo, S. Pampanin, S. Pei, and J. v. d. Lindt, "Pres-Lam Buildings: State-of-the-Art," *Journal of Structural Engineering*, vol. 146, no. 6, p. 04020085, 2020, doi: doi:10.1061/(ASCE)ST.1943-541X.0002603.
- [169] F. Wanninger, "Post-tensioned timber frame structures," Doctoral thesis, 2015, doi: 10.3929/ethz-a-010532970.
- [170] F. Wanninger, "Fast assembled post-tensioned timber frames," presented at the 7th Forum International Bois Construction, FBC 2017, 2017.
- [171] BBV Systems. "Post-tensioning systems." www.bbv-systems.com (accessed 22 March, 2021).
- [172] B. Dujic, K. Pirmanšek, R. Zarnić, and A. Ceccotti, "Prediction of dynamic response of a 7-storey massive Xlam wooden building tested on a shaking table," *World Conference on Timber Engineering*, 11/07 2010.
- [173] I. Gavric, M. Fragiaco, and A. Ceccotti, "Cyclic behaviour of typical metal connectors for cross-laminated (CLT) structures," *Materials and Structures*, vol. 48, no. 6, pp. 1841–1857, 2015/06/01 2015, doi: 10.1617/s11527-014-0278-7.
- [174] I. Sustersic, M. Fragiaco, and B. Dujic, "Seismic Analysis of Cross-Laminated Multistory Timber Buildings Using Code-Prescribed Methods: Influence of Panel Size, Connection Ductility, and Schematization," *Journal of Structural Engineering*, vol. 142, no. 4, p. E4015012, 2016, doi: doi:10.1061/(ASCE)ST.1943-541X.0001344.
- [175] P. Aondio, P. Glaser, and H. Kreuzinger, "FE-Berechnung von geklebtem Brettsperrholz - Teil 2: Beispiele," *Bauingenieurur*, vol. 95, no. 2, VDI Fachmedien, p. 4, 2020.
- [176] M. Gräfe, P. Dietsch, and S. Winter, *CLT under in-plane loads: Investigation on stress distribution and creep*. 2018.
- [177] F. Wanninger, A. Frangi, and M. Fragiaco, "Long-Term Behavior of Post-tensioned Timber Connections," *Journal of Structural Engineering*, vol. 141, no. 6, p. 04014155, 2015, doi: doi:10.1061/(ASCE)ST.1943-541X.0001121.
- [178] J. W. G. Van de Kuilen and Z. Xia, "Lateral behavior of post-tensioned cross laminated timber walls using finite element analysis," presented at the WCTE 2014: Proceedings of the World Conference on Timber Engineering, Quebec, Canada, 10-14 August 2014, 2014-08-10, 2014. [Online]. Available: <http://resolver.tudelft.nl/uuid:bedab420-3c45-44f6-821e-4ba87ca35f50>.
- [179] F. Sarti, A. Palermo, and S. Pampanin, "Quasi-Static Cyclic Testing of Two-Thirds Scale Unbonded Posttensioned Rocking Dissipative Timber Walls," *Journal of Structural Engineering*, vol. 142, no. 4, p. E4015005, 2016, doi: doi:10.1061/(ASCE)ST.1943-541X.0001291.

- [180] I. Lukacs, A. Björnfort, and R. Tomasi, "Strength and stiffness of cross-laminated timber (CLT) shear walls: State-of-the-art of analytical approaches," *Engineering Structures*, vol. 178, pp. 136-147, 2019/01/01/ 2019, doi: <https://doi.org/10.1016/j.engstruct.2018.05.126>.
- [181] A. Palermo, S. Pampanin, and A. H. Buchanan, "Experimental investigations on LVL seismic resistant wall and frame subassemblies," presented at the Proceedings of the 1st european conference on earthquake engineering and seismology ECEES, Geneva, Switzerland 01/01, 2006.
- [182] A. Palermo, S. Pampanin, M. Fragiaco, A. H. Buchanan, and B. L. Deam, "Innovative seismic solutions for multi-storey LVL timber buildings," presented at the 9th World Conference on Timber Engineering WCTE 2006, Portland (U.S.A.), 2006.
- [183] S. Pampanin, A. Palermo, A. Buchanan, M. Fragiaco, and B. L. Deam, "Code Provisions for Seismic Design of Multi-storey Post-tensioned Timber Buildings," presented at the 39th Meeting of the Working Commission W18-Timber Structures, CIB, International Council for Research and Innovation, Florence, Italy, 28-31 Aug 2006, 2006.
- [184] M. P. Newcombe, S. Pampanin, A. Buchanan, and A. Palermo, "Section Analysis and Cyclic Behavior of Post-Tensioned Jointed Ductile Connections for Multi-Story Timber Buildings," *Journal of Earthquake Engineering*, vol. 12, no. sup1, pp. 83-110, 2008/04/11 2008, doi: 10.1080/13632460801925632.
- [185] M. P. Newcombe, "Seismic design of multistorey post-tensioned timber buildings " Master Thesis, Istituto Universitario di Studi Superiori di Pavia Università degli Studi di Pavia, 2008.
- [186] W. Beerschoten, A. Palermo, D. Carradine, F. Sarti, and A. Buchanan, "Experimental Investigation on the Stiffness of Beam-Column Connections in Post-Tensioned Timber Frames," presented at the *Proceedings of the structural engineering world congress*, Como, Italy, 2011.
- [187] W. Van Beerschoten, A. Palermo, D. Carradine, and A. Buchanan, "Failure criteria for post-tensioned timber beams," presented at the *Proceedings of the CIB-W18 conference*, Vaxjo, Sweden, 2012.
- [188] T. Smith, M. Fragiaco, S. Pampanin, and A. H. Buchanan, "Construction time and cost for post-tensioned timber buildings," *Proceedings of the Institution of Civil Engineers - Construction Materials*, vol. 162, no. 4, pp. 141-149, 2009, doi: 10.1680/coma.2009.162.4.141.
- [189] C. P. Devereux, T. J. Holden, A. H. Buchanan, and S. Pampanin, "NMIT Arts & Media Building - Damage Mitigation Using Post-tensioned Timber Walls," 01/01 2011.
- [190] T. Holden, C. Devereux, S. Haydon, A. Buchanan, and S. Pampanin, "NMIT Arts & Media Building— Innovative structural design of a three storey post-tensioned timber building," *Case Studies in Structural Engineering*, vol. 6, pp. 76-83, 2016/12/01/ 2016, doi: <https://doi.org/10.1016/j.csse.2016.06.003>.
- [191] A. Palermo, F. Sarti, A. Baird, and D. Dekker, "From theory to practice: design, analysis and construction of dissipative timber rocking post-Tensioning wall system for Carterton Events Centre, New Zealand. 2012.
- [192] T. Smith *et al.*, "Experimental Investigations of Post-Tensioned Timber Frames with Advanced Seismic Damping Systems," in *Structures Congress 2012*, 2012, pp. 1745-1754.
- [193] M. P. Newcombe, M. Cusieli, S. Pampanin, A. Palermo, and A. Buchanan, "Simplified design of post-tensioned-timber-frames," presented at the *Proceedings of the CIB-W18 conference New Zealand: Nelson*, 2010.
- [194] M. P. Newcombe, "Seismic design of post-tensioned timber frame and wall buildings," Doctor of Philosophy, Department of Civil and Natural Resources Engineering, University of Canterbury, New Zealand, 2011.
- [195] R. B. Zimmerman and E. McDonnell, "Framework-A tall re-centering mass timber building in the United States," 2017.
- [196] S. Pei *et al.*, "Experimental Seismic Response of a Resilient 2-Story Mass-Timber Building with Post-Tensioned Rocking Walls," *Journal of Structural Engineering*, vol. 145, no. 11, p. 04019120, 2019/11/01 2019, doi: 10.1061/(ASCE)ST.1943-541X.0002382.

- [197] D. Moroder, T. Smith, A. Dunbar, S. Pampanin, and A. Buchanan, "Seismic testing of post-tensioned Pres-Lam core walls using cross laminated timber," *Engineering Structures*, vol. 167, pp. 639-654, 2018/07/15/ 2018, doi: <https://doi.org/10.1016/j.engstruct.2018.02.075>.
- [198] R. Brown Justin, M. Li, A. Palermo, S. Pampanin, and F. Sarti, "Experimental Testing of a Low-Damage Post-Tensioned C-Shaped CLT Core-Wall," *Journal of Structural Engineering*, vol. 147, no. 3, p. 04020357, 2021/03/01 2021, doi: 10.1061/(ASCE)ST.1943-541X.0002926.
- [199] D. S. Pilon, A. Palermo, F. Sarti, and A. Salenikovich, "Benefits of multiple rocking segments for CLT and LVL Pres-Lam wall systems," *Soil Dynamics and Earthquake Engineering*, vol. 117, pp. 234-244, 2019/02/01/ 2019, doi: <https://doi.org/10.1016/j.soildyn.2018.11.026>.
- [200] D. Moroder, F. Sarti, A. Palermo, S. Pampanin, A. H., and Buchanan, "Experimental investigation of wall-to-floor connections in post-tensioned timber buildings," 2014.
- [201] M. Fragiaco and M. Davies, "Long-Term Behavior of Prestressed LVL Members. II: Analytical Approach," *Journal of Structural Engineering*, vol. 137, no. 12, pp. 1562-1572, 2011/12/01 2011, doi: 10.1061/(ASCE)ST.1943-541X.0000410.
- [202] M. Davies and M. Fragiaco, "Long-Term Behavior of Prestressed LVL Members. I: Experimental Tests," *Journal of Structural Engineering*, vol. 137, no. 12, pp. 1553-1561, 2011/12/01 2011, doi: 10.1061/(ASCE)ST.1943-541X.0000405.
- [203] E. Winkler, *Die Lehre von der Elasticitaet und Festigkeit: mit besonderer Rücksicht auf ihre Anwendung in der Technik, für polytechnische Schulen, Bauakademien, Ingenieure, Maschinenbauer, Architecten, etc.* H. Dominicus, 1867.
- [204] F. Wanninger, A. Frangi, and R. Steiger, "Bearing stiffness in wood-to-wood compression joints," *Engineering Structures*, vol. 101, pp. 631-640, 2015/10/15/ 2015, doi: <https://doi.org/10.1016/j.engstruct.2015.07.032>.
- [205] European Committee of Standardization (CEN). *EN 408:2010+A1: Timber structures - Structural timber and glued laminated timber - Determination of some physical and mechanical properties*, Brussels, Belgium, 2012.
- [206] European Committee of Standardization (CEN). *EN 13183-1:2002: Moisture content of a piece of sawn timber - Part 1: Determination by oven dry method*, Brussels, Belgium, 2007.
- [207] European Committee of Standardization (CEN). *EN 14374:2004: Timber structures - Structural laminated veneer lumber - Requirements*, Brussels, Belgium, 2004.
- [208] L. Reumschuessel, "Post-Tensioned CLT-connections (Temporary title)," Master of Science, Chair of Timber Structures and Building Construction, TUM Department of Civil, Geo and Environmental Engineering, Technical University of Munich, Munich, Germany, 2021/22.
- [209] F. Wanninger and A. Frangi, "Investigation of a post-tensioned timber connection," ETH Zurich, Switzerland: Institute of Structural Engineering – Timber Structures 2014.
- [210] F. Wanninger and A. Frangi, "Experimental Analysis of a Post-tensioned Timber Connection," Dordrecht, 2014: Springer Netherlands, in *Materials and Joints in Timber Structures*, pp. 57-66.
- [211] TUM, "Presentation of the mock-up implementation and further considerations - Pro-GET-onE," in *WP 7 - 5th project meeting, 21-23 May 2019*, P.-G.-o. Consortium, Ed., ed. Bologna (IT), 2019.
- [212] F. Zucchini, "Progetto di un nuovo involucro nel caso di un edificio a Brasov," Single Cycle Degree/Combined Bachelor and Master in Architecture and Building Engineering Master Thesis, Department of Architecture, University of Bologna - Alma Mater Studiorum, Bologna, 2020.
- [213] A. Kontadakis, A. Tsangrassoulis, L. Doulos, and S. Zerefos, "A Review of Light Shelf Designs for Daylit Environments," *Sustainability*, vol. 10, no. 1, p. 71, 2018.
- [214] E. Yüksel *et al.*, "Behaviour of steel cushions subjected to combined actions," *Bulletin of Earthquake Engineering*, vol. 16, no. 2, pp. 707-729, 2018/02/01 2018, doi: 10.1007/s10518-017-0217-4.

Appendix

Following the content of the manuscript, the technical drawings developed within the research project by the author are listed in this section and attached to the main document.

A – Structural drawings of the Building FEPA at the University Campus of Zografou, Athens (Greece)

- Layout 1 – Initial State. Plan of the assumed foundations. Scale 1:50
- Layout 2 – Initial State. Typical plan. Scale 1:50
- Layout 3 – Initial State. Vertical cross section A-A. Scale 1:50
- Layout 4 – Initial State. Vertical cross section B-B. Scale 1:50
- Layout 5 – Project. Plan of the foundations. Scale 1:50
- Layout 6 – Project. Details of the foundations. Scale 1:50
- Layout 7 – Project. Typical plan. Scale 1:50
- Layout 8 – Project. Plan of the roof extension with Vierendeel. Scale 1:50
- Layout 9 – Project. Vertical cross sections A-A and D-D. Scale 1:50
- Layout 10 – Project. Vertical cross section B-B. Scale 1:50
- Layout 11 – Project. Vertical cross section C-C. Scale 1:50
- Layout 12 – Project. Vertical cross section E-E. Scale 1:50

B – PT-CLT connection test

- Layout 1 – PTT2 setup and wooden components. Scale 1:10
- Layout 2 – PTT3 setup and wooden components. Scale 1:10
- Layout 3 – PTT4 setup and wooden components. Scale 1:10
- Layout 4 – PTT5 setup and wooden components. Scale 1:10
- Layout 5 – Composite steel connection plates, anchor plates and threaded rod. Scale 1:10

C – Architectural drawings of the Building FEPA at the University Campus of Zografou, Athens (Greece)

- Layout 1 – Project. Ground floor. Scale 1:50
- Layout 2 – Project. First floor. Scale 1:50
- Layout 3 – Project. Second floor. Scale 1:50
- Layout 4 – Project. Third floor. Scale 1:50
- Layout 5 – Project. Roof floor. Scale 1:50
- Layout 6 – Project. Rooftop floor. Scale 1:50
- Layout 7 – Project. North-West Façade. Scale 1:50
- Layout 8 – Project. South-East Façade. Scale 1:50
- Layout 9 – Project. South-West and North-East Façades. Scale 1:50
- Layout 10 – Project. Vertical cross section B-B. Scale 1:50
- Layout 11 – Project. Vertical cross sections A-A and C-C. Scale 1:50
- Layout 12 – Project. Details of the balcony unit with composed steel and LW concrete slab. Scale 1:20
- Layout 13 – Project. Details of the balcony unit with composed steel and LW concrete slab. Scale 1:10
- Layout 14 – Project. Details of the balcony unit with aluminium slab. Scales 1:10 and 1:20
- Layout 15 – Project. Details of the balcony unit with CLT slab. Scales 1:10 and 1:20
- Layout 16 – Project. Details of the extra-room/sun-space units. Scale 1:20
- Layout 17 – Project. Details of the extra-room/sun-space units. Scale 1:10

D – Architectural drawings of the moment-resisting RC building, Brasov (Romania)

Layout 1 – Project. Typical façade in different configurations. Scale 1:100

Layout 2 – Project. Typical plan providing the extra-room units. Scale 1:50

Layout 3 – Project. Vertical cross-sections A-A and B-B providing the extra-room units. Scale 1:50

Layout 4 – Project. Details of the balcony unit. Scales 1:10 and 1:20

Layout 5 – Project. Details of the sun-space unit. Scales 1:10 and 1:20

Layout 6 – Project. Details of the extra-room unit. Scales 1:10 and 1:20

Layout 7 – Project. Details of roof and foundation applied to all unit solutions. Scale 1:20

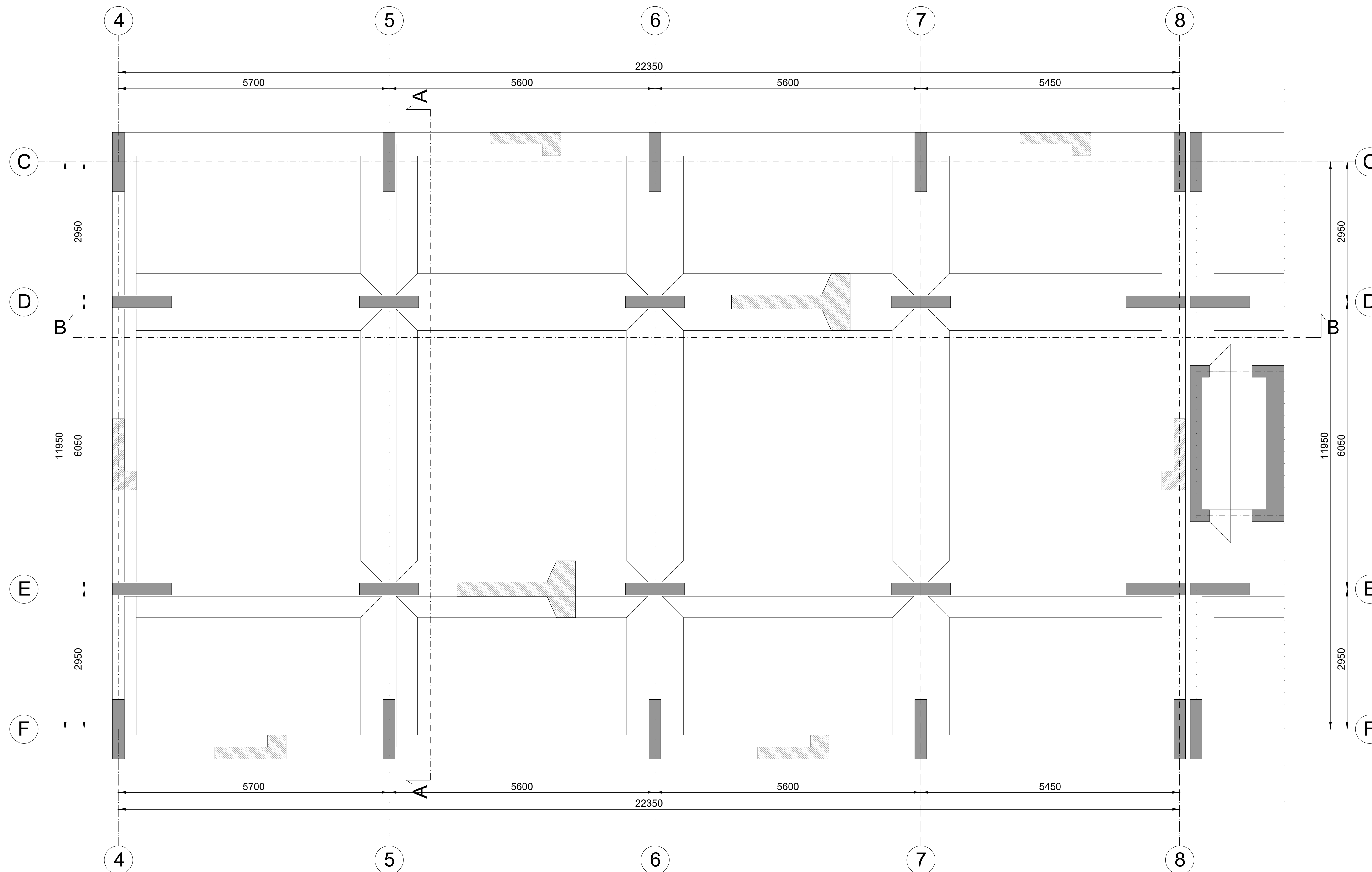

Materials

Reinforced concrete existing structure

Concrete
 - Class C20/25
 - $f_{ck}=20.2$ MPa

Rebar
 - S400
 - $f_{yk}=400$ MPa - $f_{tk}=500$ MPa

Reinforced concrete new foundations

Concrete
 - Class C25/30
 - $f_{ck}=25$ MPa

Rebar
 - B450C
 - $f_{yk}=450$ MPa - $f_{tk}=540$ MPa

Steel - Micropiles
 - Grade S355
 - $f_{yk}=355$ MPa - $f_{tk}=510$ MPa

Steel - GET System

S235 - Bracing pipe
 - $f_{yk}=235$ MPa - $f_{tk}=360$ MPa

S275 - All other profiles
 - $f_{yk}=275$ MPa - $f_{tk}=430$ MPa

Data from structural survey
 Knowledge Level - 2

CF = 1.2

Standards

Design - Verifications

- Eurocode - Basis of structural design - EN 1990 (2002)
- Eurocode 2 - Design of concrete structures - EN 1992 (2004)
- Eurocode 3 - Design of steel structures - EN 1993 (2005)
- Eurocode 8 - Design of structures for earthquake resistance - Part 1: General rules, seismic actions and rules for buildings - EN 1998 (2005)
- Eurocode 8 - Design of structures for earthquake resistance - Part 3: Assessment and retrofitting of buildings - EN 1998 (2005)

Seismic Parameters

- Athens - Seismic Zone I - EAK 2000 (2003)
- Spectrum - type 1
- Ground type - B
- $a_g=0.16$ g ($P_w = 10\%$; $T_r = 475$ years; $V_r = 50$ years)
- $\gamma_I = 1.2$ - Importance factor

Notes

As reported in the manuscript, checks of the steel joints were not carried out. The connections assumed in the drawings are therefore only a typological indication dictated by the chosen assembly procedures. Foundations have not been verified due to the absence of accurate information on current foundations and on the ground. It is therefore a qualitative and oversized project (for the foundations) in order to obtain estimated quantities and costs for the project.

Annexes to the doctoral thesis entitled

On the use of the exoskeleton for seismic improvement and integrated efficient technologies in existing buildings

of the candidate

Lorenzo Badini

Alma Mater Studiorum - University of Bologna
 School of Engineering and Architecture
 Department of Architecture

Technical University of Munich
 Department of Civil, Geo and Environmental Engineering
 Chair of Timber Structures and Building Construction

Case Study:

Building FEPA at University Campus of Zografou, Athens (Greece)
 Structural Drawings

Contents

Initial State
 Assumed foundations - Plan
 Scale 1:50

Board N°

1

Acknowledgement

Proactive synergy of inteGrated Efficient Technologies on buildings Envelopes. The outputs of this research are part of the Pro-GET-onE project, which has received funding from the European Union's Horizon 2020 Innovation action under grand agreement No 723747



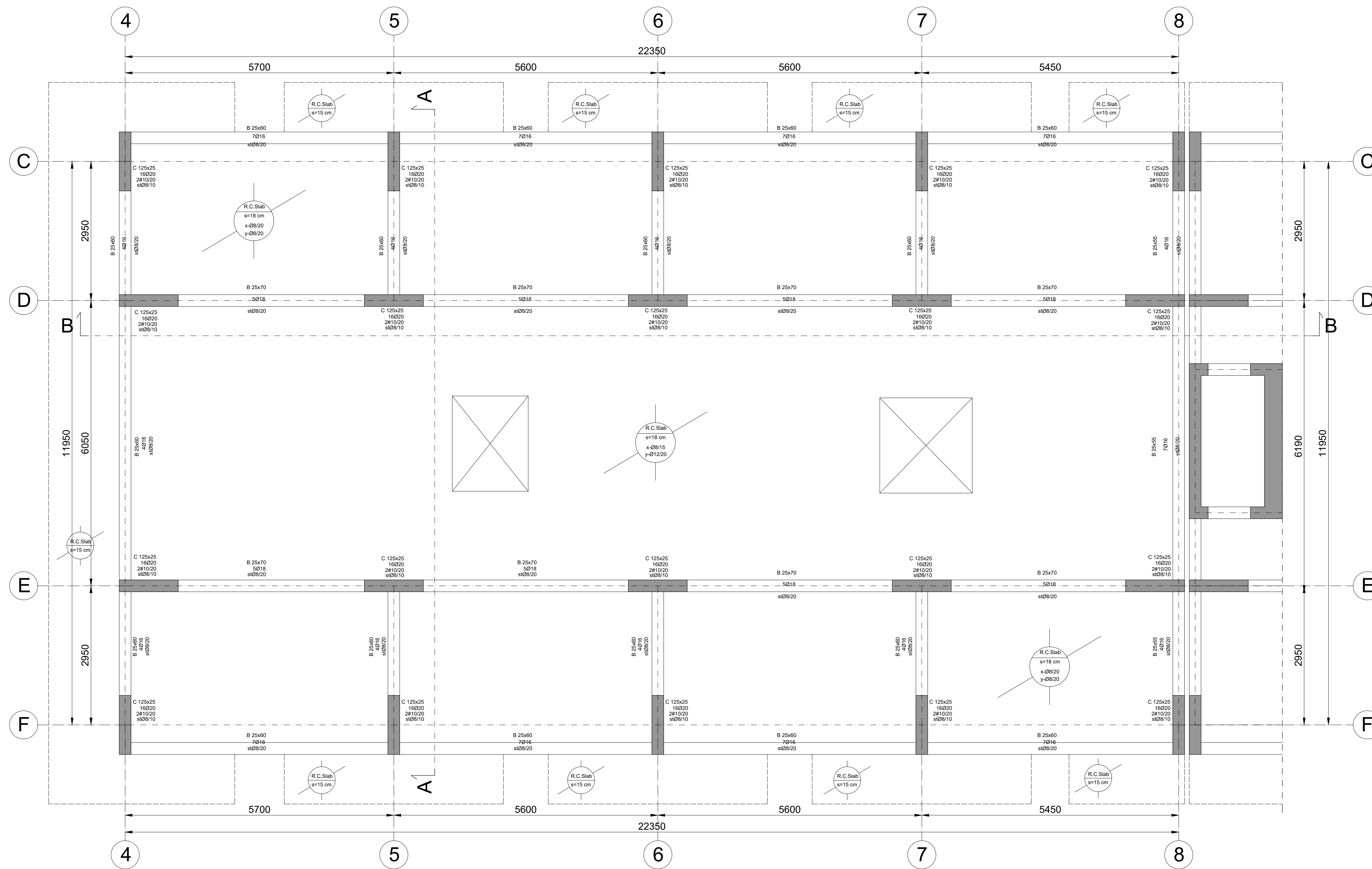

Materials

Reinforced concrete existing structure

Concrete
- Class C20/25
- $f_{ck}=20.2$ MPa

Rebar
- S400
- $f_{yk}=400$ MPa - $f_{tk}=500$ MPa

Reinforced concrete new foundations

Concrete
- Class C25/30
- $f_{ck}=25$ MPa

Rebar
- B450C
- $f_{yk}=450$ MPa - $f_{tk}=540$ MPa

Steel - Micropiles
- Grade S355
- $f_{yk}=355$ MPa - $f_{tk}=510$ MPa

Steel - GET System

S235 - Bracing pipe
- $f_{yk}=235$ MPa - $f_{tk}=360$ MPa

S275 - All other profiles
- $f_{yk}=275$ MPa - $f_{tk}=430$ MPa

Data from structural survey
Knowledge Level - 2

CF = 1.2

Standards

Design - Verifications

- Eurocode - Basis of structural design - EN 1990 (2002)
- Eurocode 2 - Design of concrete structures - EN 1992 (2004)
- Eurocode 3 - Design of steel structures - EN 1993 (2005)
- Eurocode 8 - Design of structures for earthquake resistance - Part 1: General rules, seismic actions and rules for buildings - EN 1998 (2005)
- Eurocode 8 - Design of structures for earthquake resistance - Part 3: Assessment and retrofitting of buildings - EN 1998 (2005)

Seismic Parameters

- Athens - Seismic Zone I - EAK 2000 (2003)
- Spectrum - type 1
- Ground type - B
- $a_g=0.16$ g ($P_w = 10\%$; $T_r = 475$ years; $V_r = 50$ years)
- $\gamma_I=1.2$ - Importance factor

Notes

As reported in the manuscript, checks of the steel joints were not carried out. The connections assumed in the drawings are therefore only a typological indication dictated by the chosen assembly procedures. Foundations have not been verified due to the absence of accurate information on current foundations and on the ground. It is therefore a qualitative and oversized project (for the foundations) in order to obtain estimated quantities and costs for the project.

Annexes to the doctoral thesis entitled

On the use of the exoskeleton for seismic improvement and integrated efficient technologies in existing buildings

of the candidate

Lorenzo Badini

Alma Mater Studiorum - University of Bologna
School of Engineering and Architecture
Department of Architecture

Technical University of Munich
Department of Civil, Geo and Environmental Engineering
Chair of Timber Structures and Building Construction

Case Study:

Building FEPA at University Campus of Zografou, Athens (Greece)
Structural Drawings

Contents

Initial State
Typical Plan - Horizontal cross section
Scale 1:50

Board N°

2

Acknowledgement

Proactive synergy of inteGrated Efficient Technologies on buildings Envelopes. The outputs of this research are part of the Pro-GET-onE project, which has received funding from the European Union's Horizon 2020 Innovation action under grand agreement No 723747



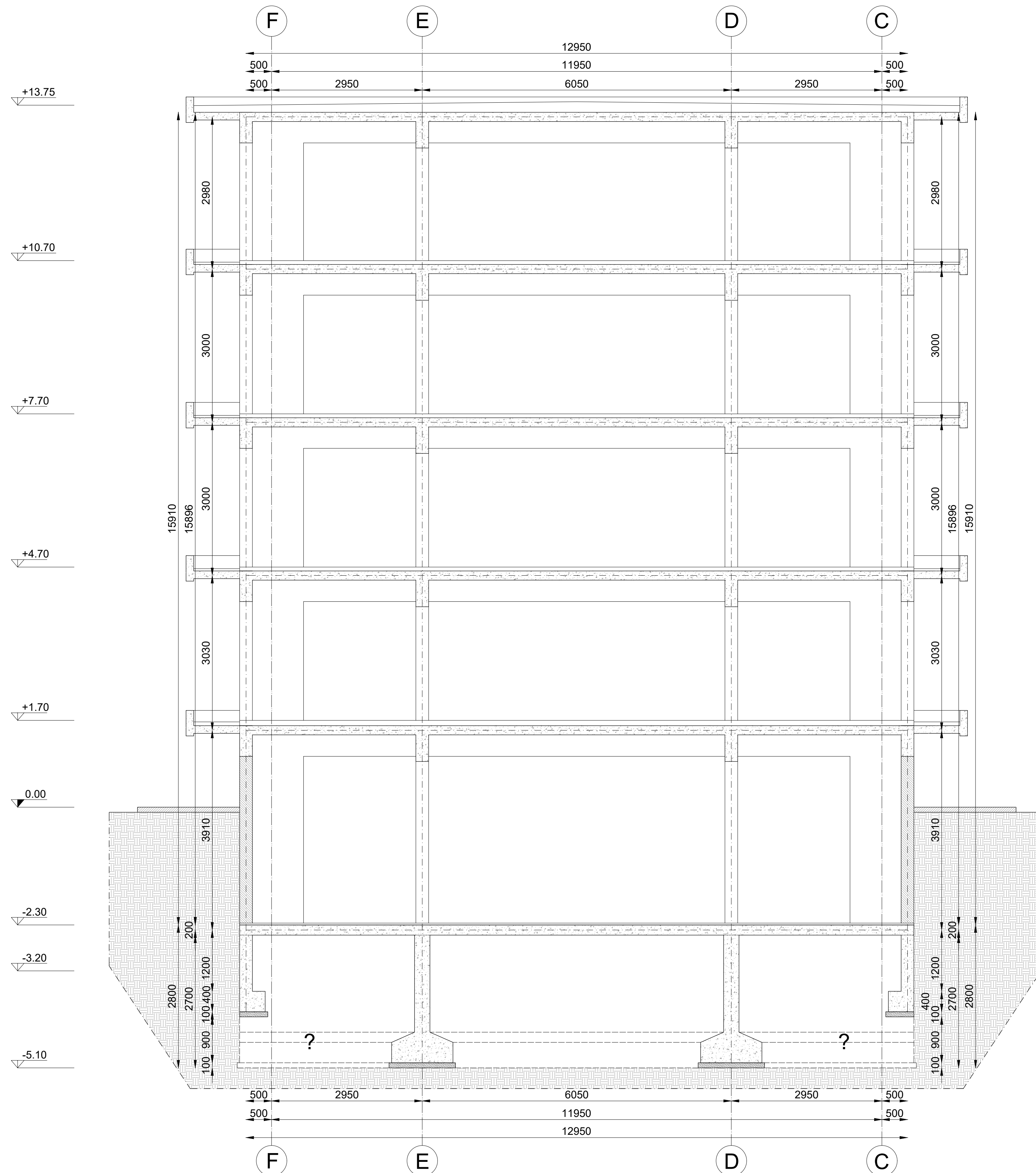

Materials

Reinforced concrete existing structure

Concrete
 - Class C20/25
 - $f_{ck}=20.2$ MPa

Rebar
 - S400
 - $f_{yk}=400$ MPa - $f_{tk}=500$ MPa

Reinforced concrete new foundations

Concrete
 - Class C25/30
 - $f_{ck}=25$ MPa

Rebar
 - B450C
 - $f_{yk}=450$ MPa - $f_{tk}=540$ MPa

Steel - Micropiles
 - Grade S355
 - $f_{yk}=355$ MPa - $f_{tk}=510$ MPa

Steel - GET System

S235 - Bracing pipe
 - $f_{yk}=235$ MPa - $f_{tk}=360$ MPa

S275 - All other profiles
 - $f_{yk}=275$ MPa - $f_{tk}=430$ MPa

Data from structural survey
 Knowledge Level - 2

CF = 1.2

Standards

Design - Verifications

- Eurocode - Basis of structural design - EN 1990 (2002)
- Eurocode 2 - Design of concrete structures - EN 1992 (2004)
- Eurocode 3 - Design of steel structures - EN 1993 (2005)
- Eurocode 8 - Design of structures for earthquake resistance - Part 1: General rules, seismic actions and rules for buildings - EN 1998 (2005)
- Eurocode 8 - Design of structures for earthquake resistance - Part 3: Assessment and retrofitting of buildings - EN 1998 (2005)

Seismic Parameters

- Athens - Seismic Zone I - EAK 2000 (2003)
- Spectrum - type 1
- Ground type - B
- $a_g=0.16$ g ($P_w = 10\%$; $T_r = 475$ years; $V_r = 50$ years)
- $\gamma_I = 1.2$ - Importance factor

Notes

As reported in the manuscript, checks of the steel joints were not carried out. The connections assumed in the drawings are therefore only a typological indication dictated by the chosen assembly procedures. Foundations have not been verified due to the absence of accurate information on current foundations and on the ground. It is therefore a qualitative and oversized project (for the foundations) in order to obtain estimated quantities and costs for the project.

Annexes to the doctoral thesis entitled

On the use of the exoskeleton for seismic improvement and integrated efficient technologies in existing buildings

of the candidate

Lorenzo Badini

Alma Mater Studiorum - University of Bologna
 School of Engineering and Architecture
 Department of Architecture

Technical University of Munich
 Department of Civil, Geo and Environmental Engineering
 Chair of Timber Structures and Building Construction

Case Study:

Building FEPA at University Campus of Zografou, Athens (Greece)
 Structural Drawings

Contents

Initial State
 Vertical cross section A-A
 Scale 1:50

Board N°

3

Acknowledgement

Proactive synergy of inteGrated Efficient Technologies on buildings Envelopes. The outputs of this research are part of the Pro-GET-onE project, which has received funding from the European Union's Horizon 2020 Innovation action under grand agreement No 723747



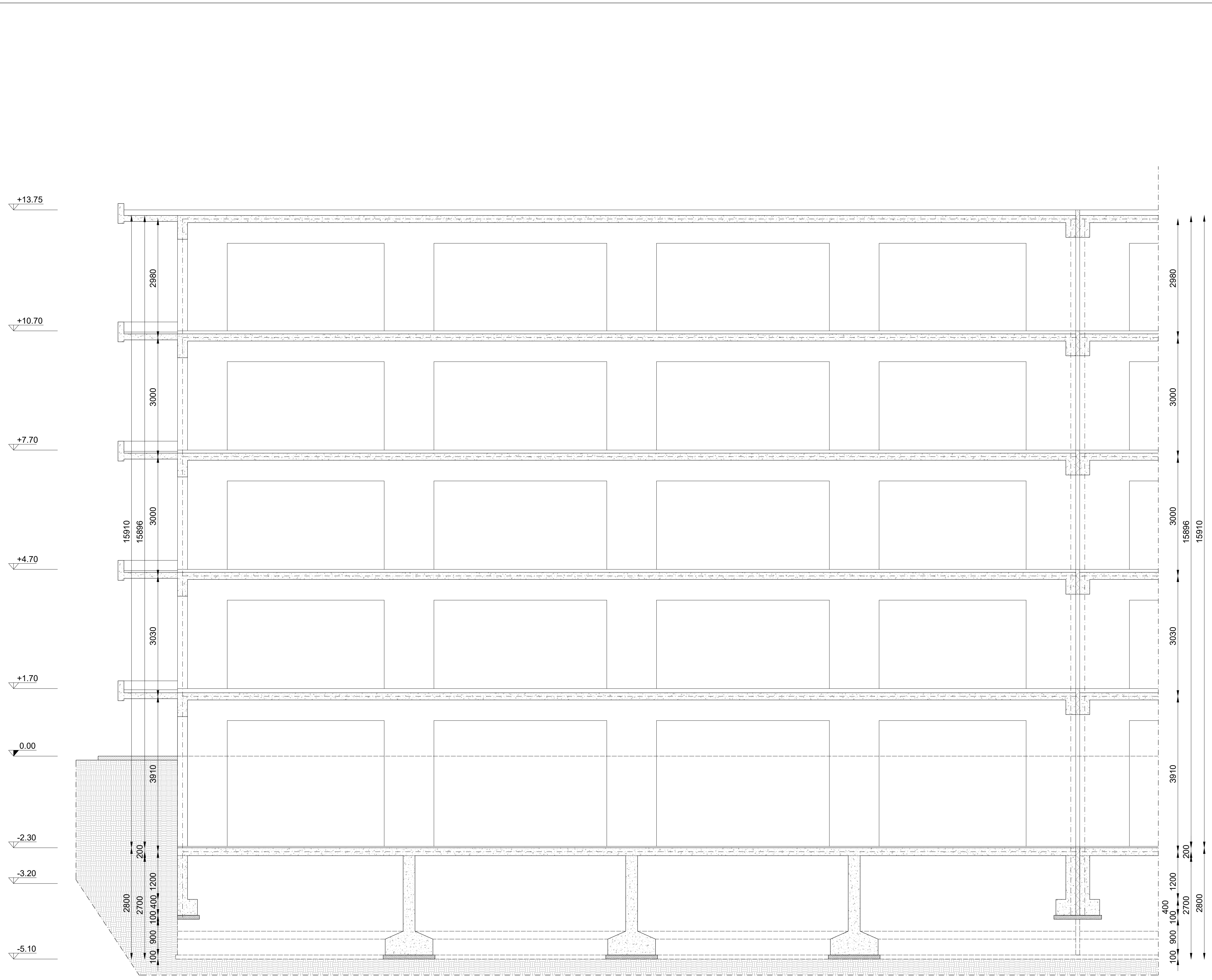

Materials	
Reinforced concrete existing structure Concrete - Class C20/25 - $f_{ck}=20.2$ MPa Rebar - S400 - $f_{yk}=400$ MPa - $f_{tk}=500$ MPa	Data from structural survey Knowledge Level - 2 CF = 1.2
Reinforced concrete new foundations Concrete - Class C25/30 - $f_{ck}=25$ MPa Rebar - B450C - $f_{yk}=450$ MPa - $f_{tk}=540$ MPa Steel - Micropiles - Grade S355 - $f_{yk}=355$ MPa - $f_{tk}=510$ MPa Steel - GET System S235 - Bracing pipe - $f_{yk}=235$ MPa - $f_{tk}=360$ MPa S275 - All other profiles - $f_{yk}=275$ MPa - $f_{tk}=430$ MPa	
Standards	
Design - Verifications - Eurocode - Basis of structural design - EN 1990 (2002) - Eurocode 2 - Design of concrete structures - EN 1992 (2004) - Eurocode 3 - Design of steel structures - EN 1993 (2005) - Eurocode 8 - Design of structures for earthquake resistance - Part 1: General rules, seismic actions and rules for buildings - EN 1998 (2005) - Eurocode 8 - Design of structures for earthquake resistance - Part 3: Assessment and retrofitting of buildings - EN 1998 (2005)	
Seismic Parameters - Athens - Seismic Zone I - EAK 2000 (2003) - Spectrum - type 1 - Ground type - B - $a_g=0.16$ g ($P_{vr} = 10\%$; $T_r = 475$ years; $V_r = 50$ years) - $\gamma_I = 1.2$ - Importance factor	
Notes	
As reported in the manuscript, checks of the steel joints were not carried out. The connections assumed in the drawings are therefore only a typological indication dictated by the chosen assembly procedures. Foundations have not been verified due to the absence of accurate information on current foundations and on the ground. It is therefore a qualitative and oversized project (for the foundations) in order to obtain estimated quantities and costs for the project.	

Annexes to the doctoral thesis entitled

On the use of the exoskeleton for seismic improvement and integrated efficient technologies in existing buildings

of the candidate

Lorenzo Badini

Alma Mater Studiorum - University of Bologna
 School of Engineering and Architecture
 Department of Architecture

Technical University of Munich
 Department of Civil, Geo and Environmental Engineering
 Chair of Timber Structures and Building Construction

Case Study:

Building FEPA at University Campus of Zografou, Athens (Greece)
 Structural Drawings

Contents	Board N°
Initial State Vertical cross section B-B Scale 1:50	4

Acknowledgement

Proactive synergy of inteGrated Efficient Technologies on buildings Envelopes. The outputs of this research are part of the Pro-GET-onE project, which has received funding from the European Union's Horizon 2020 Innovation action under grand agreement No 723747



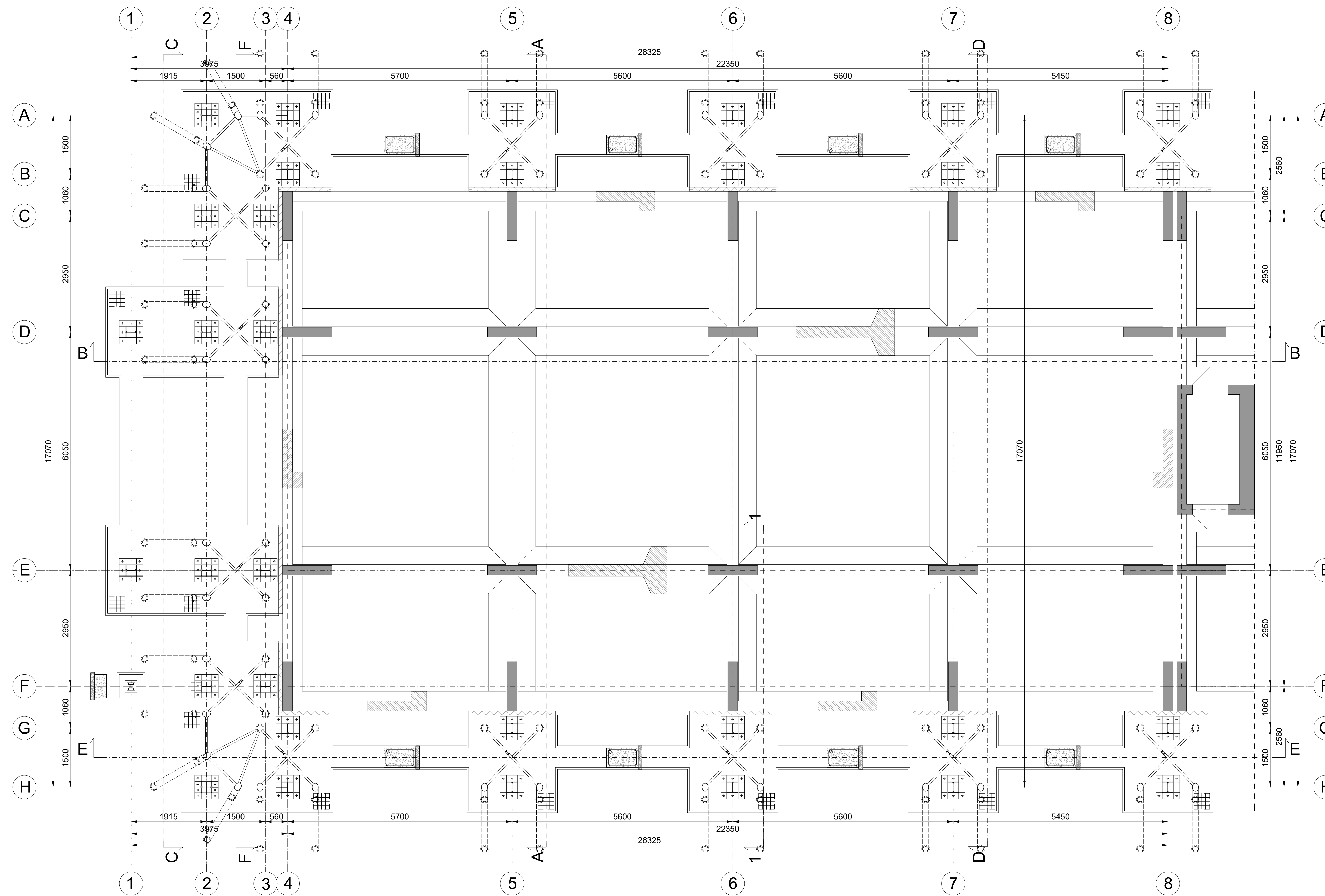

Materials

Reinforced concrete existing structure

Concrete
 - Class C20/25
 - $f_{tk}=20.2$ MPa

Rebar
 - S400
 - $f_{yk}=400$ MPa - $f_{tk}=500$ MPa

Reinforced concrete new foundations

Concrete
 - Class C25/30
 - $f_{tk}=25$ MPa

Rebar
 - B450C
 - $f_{yk}=450$ MPa - $f_{tk}=540$ MPa

Steel - Micropiles
 - Grade S355
 - $f_{yk}=355$ MPa - $f_{tk}=510$ MPa

Steel - GET System

S235 - Bracing pipe
 - $f_{yk}=235$ MPa - $f_{tk}=360$ MPa

S275 - All other profiles
 - $f_{yk}=275$ MPa - $f_{tk}=430$ MPa

Data from structural survey
 Knowledge Level - 2

CF = 1.2

Standards

Design - Verifications

- Eurocode - Basis of structural design - EN 1990 (2002)
- Eurocode 2 - Design of concrete structures - EN 1992 (2004)
- Eurocode 3 - Design of steel structures - EN 1993 (2005)
- Eurocode 8 - Design of structures for earthquake resistance - Part 1: General rules, seismic actions and rules for buildings - EN 1998 (2005)
- Eurocode 8 - Design of structures for earthquake resistance - Part 3: Assessment and retrofitting of buildings - EN 1998 (2005)

Seismic Parameters

- Athens - Seismic Zone I - EAK 2000 (2003)
- Spectrum - type 1
- Ground type - B
- $a_g=0.16$ g ($P_{ov} = 10\%$; $T_r = 475$ years; $V_r = 50$ years)
- $\gamma_I = 1.2$ - Importance factor

Notes

As reported in the manuscript, checks of the steel joints were not carried out. The connections assumed in the drawings are therefore only a typological indication dictated by the chosen assembly procedures. Foundations have not been verified due to the absence of accurate information on current foundations and on the ground. It is therefore a qualitative and oversized project (for the foundations) in order to obtain estimated quantities and costs for the project.

Annexes to the doctoral thesis entitled

On the use of the exoskeleton for seismic improvement and integrated efficient technologies in existing buildings

of the candidate

Lorenzo Badini

Alma Mater Studiorum - University of Bologna
 School of Engineering and Architecture
 Department of Architecture

Technical University of Munich
 Department of Civil, Geo and Environmental Engineering
 Chair of Timber Structures and Building Construction

Case Study:

Building FEPA at University Campus of Zografou, Athens (Greece)
 Structural Drawings

Contents

Project
 Foundations - Plan
 Scale 1:50

Board N°

5

Acknowledgement

Proactive synergy of integrated Efficient Technologies on buildings Envelopes. The outputs of this research are part of the Pro-GET-onE project, which has received funding from the European Union's Horizon 2020 Innovation action under grant agreement No 723747



Section 1-1
Initial State

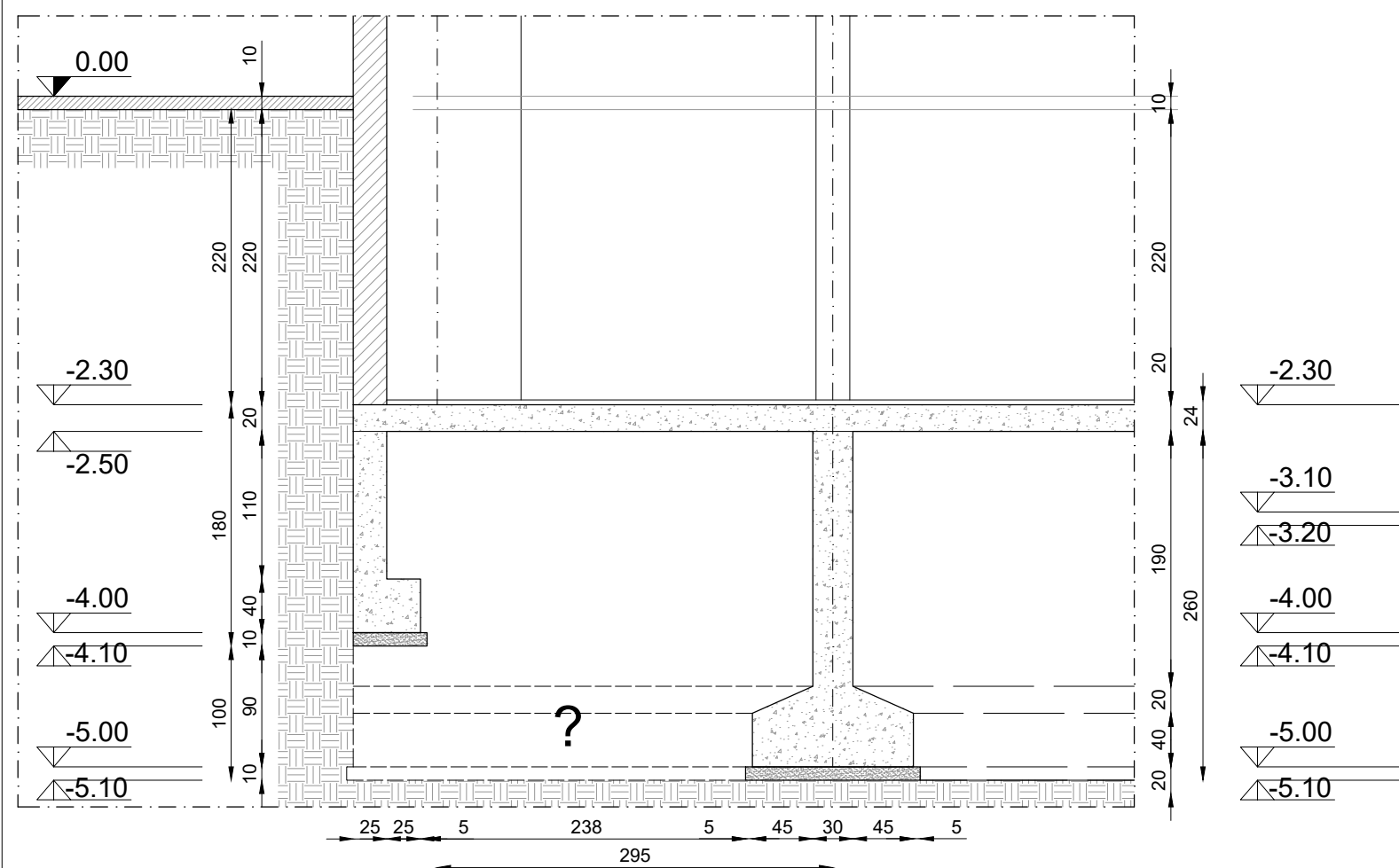

Section 1-1
Project

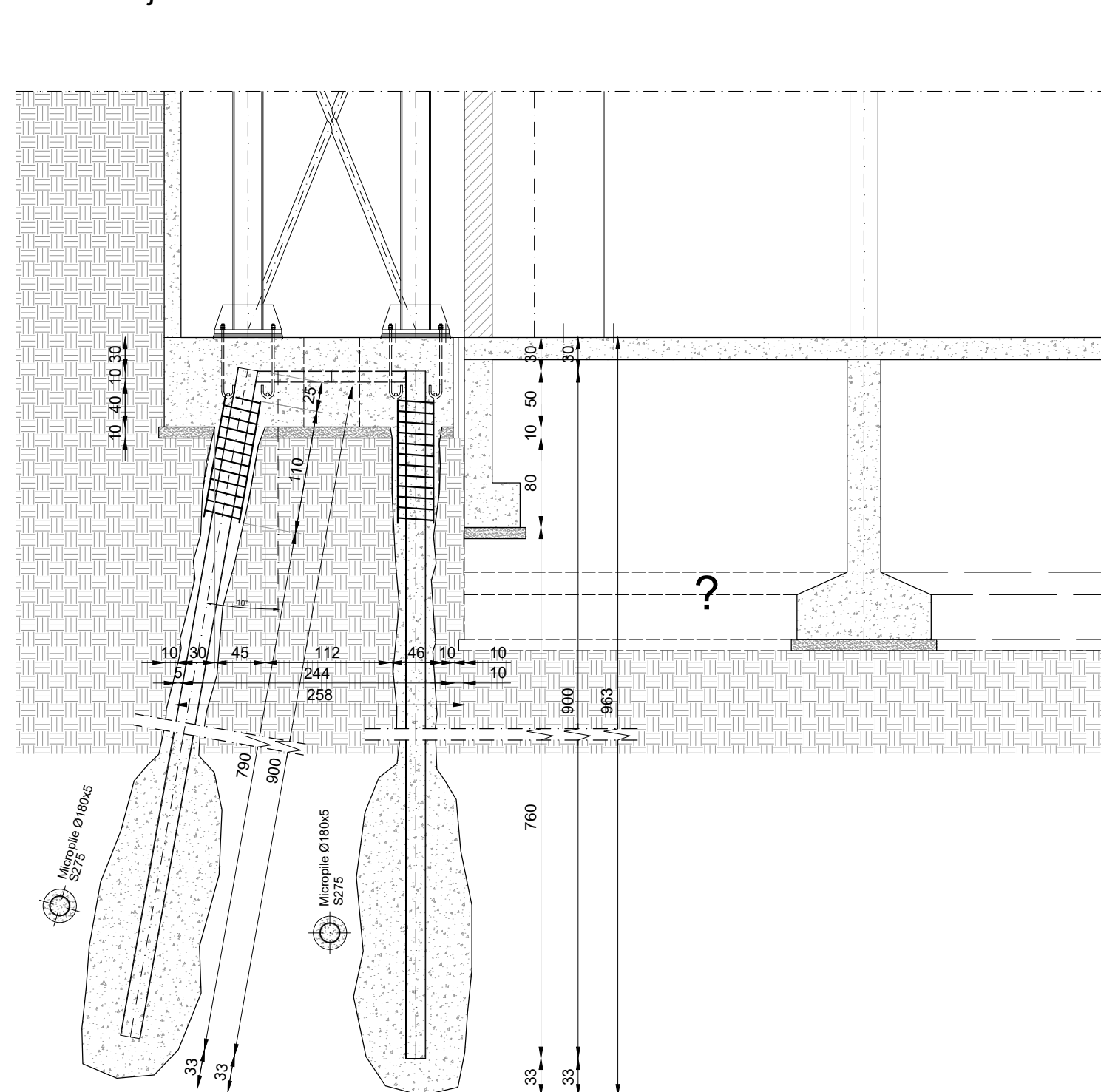

Materials

Reinforced concrete existing structure

Concrete

- Class C20/25
- $f_{ck}=20.2$ MPa

Rebar

- S400
- $f_{yk}=400$ MPa - $f_{tk}=500$ MPa

Data from structural survey
Knowledge Level - 2

CF = 1.2

Reinforced concrete new foundations

Concrete

- Class C25/30
- $f_{ck}=25$ MPa

Rebar

- B450C
- $f_{yk}=450$ MPa - $f_{tk}=540$ MPa

Steel - Micropiles

- Grade S355
- $f_{yk}=355$ MPa - $f_{tk}=510$ MPa

Steel - GET System

S235 - Bracing pipe

- $f_{yk}=235$ MPa - $f_{tk}=360$ MPa

S275 - All other profiles

- $f_{yk}=275$ MPa - $f_{tk}=430$ MPa

Standards

Design - Verifications

- Eurocode - Basis of structural design - EN 1990 (2002)
- Eurocode 2 - Design of concrete structures - EN 1992 (2004)
- Eurocode 3 - Design of steel structures - EN 1993 (2005)
- Eurocode 8 - Design of structures for earthquake resistance - Part 1: General rules, seismic actions and rules for buildings - EN 1998 (2005)
- Eurocode 8 - Design of structures for earthquake resistance - Part 3: Assessment and retrofitting of buildings - EN 1998 (2005)

Seismic Parameters

- Athens - Seismic Zone I - EAK 2000 (2003)
- Spectrum - type 1
- Ground type - B
- $a_g=0.16$ g ($P_{vr} = 10\%$; $T_r = 475$ years; $V_r = 50$ years)
- $\gamma_i=1.2$ - Importance factor

Notes

As reported in the manuscript, checks of the steel joints were not carried out. The connections assumed in the drawings are therefore only a typological indication dictated by the chosen assembly procedures.
Foundations have not been verified due to the absence of accurate information on current foundations and on the ground. It is therefore a qualitative and oversized project (for the foundations) in order to obtain estimated quantities and costs for the project.

Annexes to the doctoral thesis entitled

On the use of the exoskeleton for seismic improvement and integrated efficient technologies in existing buildings

of the candidate

Lorenzo Badini

Alma Mater Studiorum - University of Bologna
School of Engineering and Architecture
Department of Architecture

Technical University of Munich
Department of Civil, Geo and Environmental Engineering
Chair of Timber Structures and Building Construction

Case Study:

Building FEPA at University Campus of Zografou, Athens (Greece)
Structural Drawings

Contents

Foundations - Details
Scale 1:50

Board N°

6

Acknowledgement

Proactive synergy of inteGrated Efficient Technologies on buildings Envelopes. The outputs of this research are part of the Pro-GET-onE project, which has received funding from the European Union's Horizon 2020 Innovation action under grand agreement No 723747



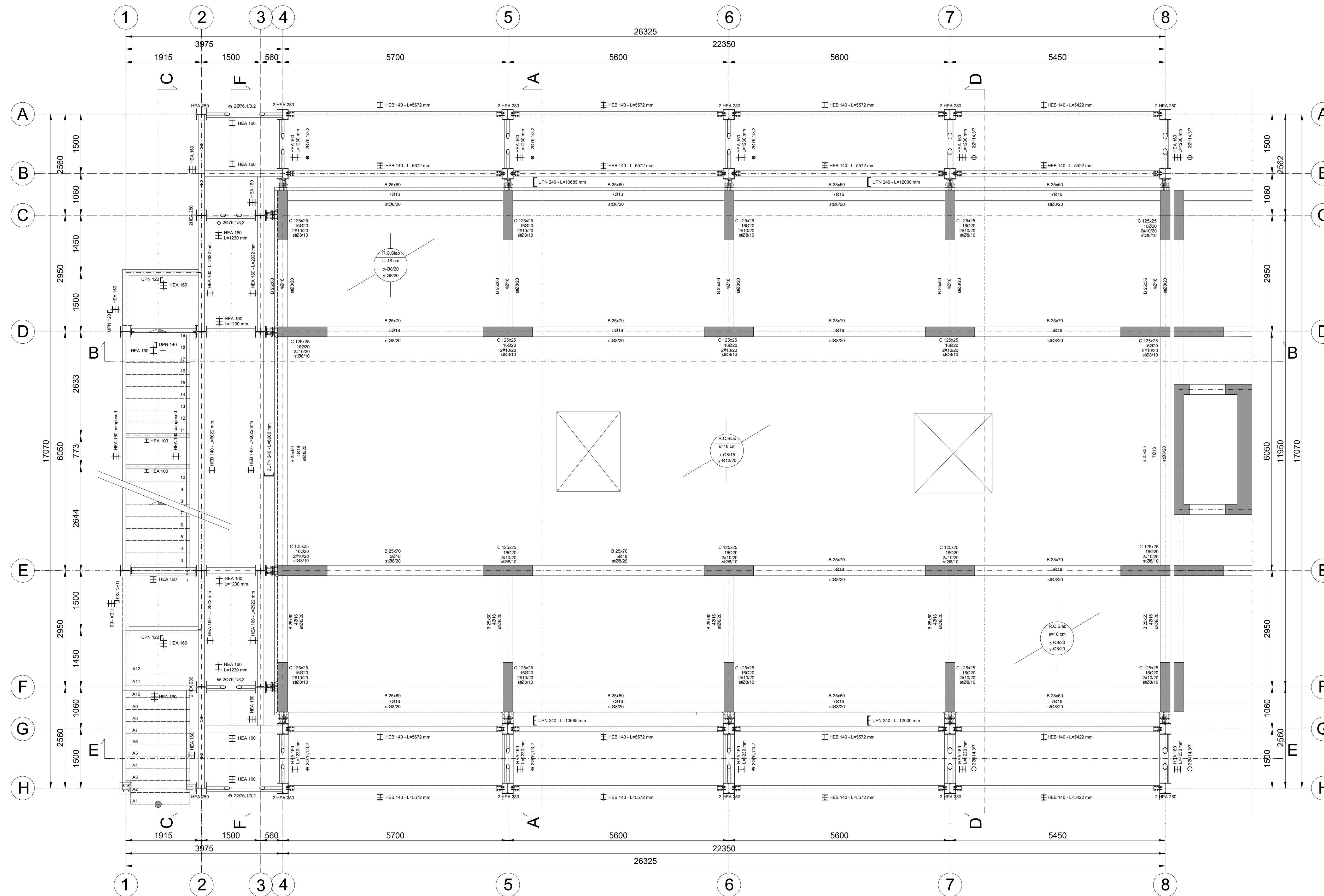

Materials

Reinforced concrete existing structure

- Concrete
 - Class C20/25
 - $f_{tk}=20.2$ MPa
- Rebar
 - S400
 - $f_{yk}=400$ MPa - $f_{tk}=500$ MPa

Data from structural survey
Knowledge Level - 2

CF = 1.2

Reinforced concrete new foundations

- Concrete
 - Class C25/30
 - $f_{tk}=25$ MPa
- Rebar
 - B450C
 - $f_{yk}=450$ MPa - $f_{tk}=540$ MPa

Steel - Micropiles

- Grade S355
- $f_{yk}=355$ MPa - $f_{tk}=510$ MPa

Steel - GET System

- S235 - Bracing pipe
 - $f_{tk}=235$ MPa - $f_{tk}=360$ MPa

- S275 - All other profiles
 - $f_{tk}=275$ MPa - $f_{tk}=430$ MPa

Standards

Design - Verifications

- Eurocode - Basis of structural design - EN 1990 (2002)
- Eurocode 2 - Design of concrete structures - EN 1992 (2004)
- Eurocode 3 - Design of steel structures - EN 1993 (2005)
- Eurocode 8 - Design of structures for earthquake resistance - Part 1: General rules, seismic actions and rules for buildings - EN 1998 (2005)
- Eurocode 8 - Design of structures for earthquake resistance - Part 3: Assessment and retrofitting of buildings - EN 1998 (2005)

Seismic Parameters

- Athens - Seismic Zone I - EAK 2000 (2003)
- Spectrum - type 1
- Ground type - B
- $a_g=0.16$ g ($P_{vr} = 10\%$; $T_r = 475$ years; $V_r = 50$ years)
- $\gamma_I = 1.2$ - Importance factor

Notes

As reported in the manuscript, checks of the steel joints were not carried out. The connections assumed in the drawings are therefore only a typological indication dictated by the chosen assembly procedures. Foundations have not been verified due to the absence of accurate information on current foundations and on the ground. It is therefore a qualitative and oversized project (for the foundations) in order to obtain estimated quantities and costs for the project.

Annexes to the doctoral thesis entitled

On the use of the exoskeleton for seismic improvement and integrated efficient technologies in existing buildings

of the candidate

Lorenzo Badini

Alma Mater Studiorum - University of Bologna
School of Engineering and Architecture
Department of Architecture

Technical University of Munich
Department of Civil, Geo and Environmental Engineering
Chair of Timber Structures and Building Construction

Case Study:

Building FEPA at University Campus of Zografou, Athens (Greece)
Structural Drawings

Contents

Project
Typical Plan - Horizontal cross section
Scale 1:50

Board N°

7

Acknowledgement

Proactive synergy of integrated Efficient Technologies on buildings Envelopes. The outputs of this research are part of the Pro-GET-onE project, which has received funding from the European Union's Horizon 2020 Innovation action under grand agreement No 723747



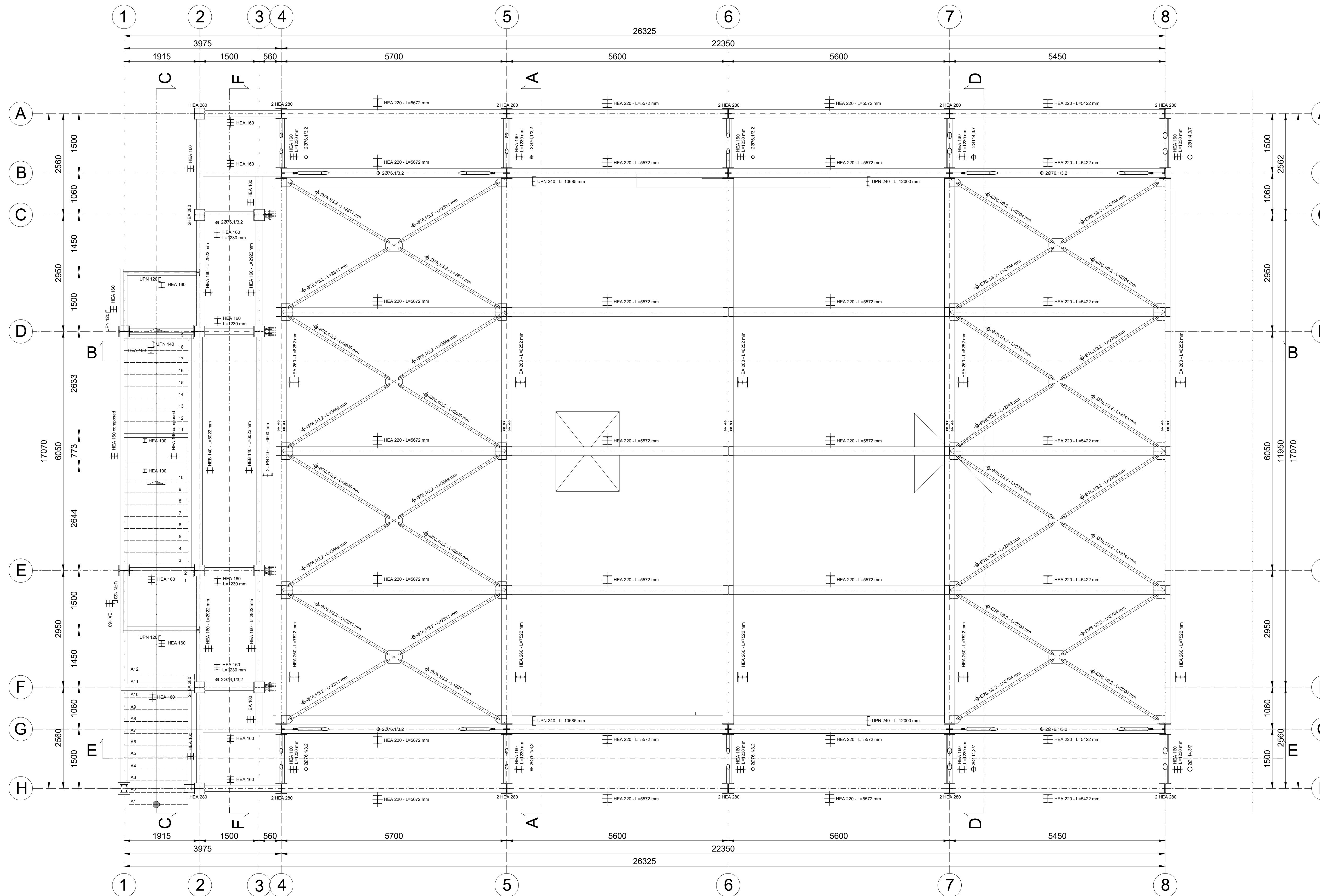

- Materials**
- Reinforced concrete existing structure**
- Concrete
 - Class C20/25
 - $f_{tk}=20.2$ MPa
 - Rebar
 - S400
 - $f_{yk}=400$ MPa - $f_{tk}=500$ MPa
- Reinforced concrete new foundations**
- Concrete
 - Class C25/30
 - $f_{tk}=25$ MPa
 - Rebar
 - B450C
 - $f_{yk}=450$ MPa - $f_{tk}=540$ MPa
 - Steel - Micropiles
 - Grade S355
 - $f_{yk}=355$ MPa - $f_{tk}=510$ MPa
- Steel - GET System**
- S235 - Bracing pipe
 - $f_{yk}=235$ MPa - $f_{tk}=360$ MPa
 - S275 - All other profiles
 - $f_{yk}=275$ MPa - $f_{tk}=430$ MPa

- Standards**
- Design - Verifications**
- Eurocode - Basis of structural design - EN 1990 (2002)
 - Eurocode 2 - Design of concrete structures - EN 1992 (2004)
 - Eurocode 3 - Design of steel structures - EN 1993 (2005)
 - Eurocode 8 - Design of structures for earthquake resistance - Part 1: General rules, seismic actions and rules for buildings - EN 1998 (2005)
 - Eurocode 8 - Design of structures for earthquake resistance - Part 3: Assessment and retrofitting of buildings - EN 1998 (2005)
- Seismic Parameters**
- Athens - Seismic Zone I - EAK 2000 (2003)
 - Spectrum - type 1
 - Ground type - B
 - $a_g=0.16$ g ($P_{ov} = 10\%$; $T_r = 475$ years; $V_r = 50$ years)
 - $\gamma_f=1.2$ - Importance factor

Notes

As reported in the manuscript, checks of the steel joints were not carried out. The connections assumed in the drawings are therefore only a typical indication dictated by the chosen assembly procedures. Foundations have not been verified due to the absence of accurate information on current foundations and on the ground. It is therefore a qualitative and oversized project (for the foundations) in order to obtain estimated quantities and costs for the project.

Annexes to the doctoral thesis entitled

On the use of the exoskeleton for seismic improvement and integrated efficient technologies in existing buildings

of the candidate

Lorenzo Badini

Alma Mater Studiorum - University of Bologna
School of Engineering and Architecture
Department of Architecture

Technical University of Munich
Department of Civil, Geo and Environmental Engineering
Chair of Timber Structures and Building Construction

Case Study:

Building FEPA at University Campus of Zografou, Athens (Greece)
Structural Drawings

Contents	Board N°
Project Vierendeel - Horizontal cross section Scale 1:50	8

Acknowledgement

Proactive synergy of integrated Efficient Technologies on buildings Envelopes. The outputs of this research are part of the Pro-GET-onE project, which has received funding from the European Union's Horizon 2020 Innovation action under grand agreement No 723747



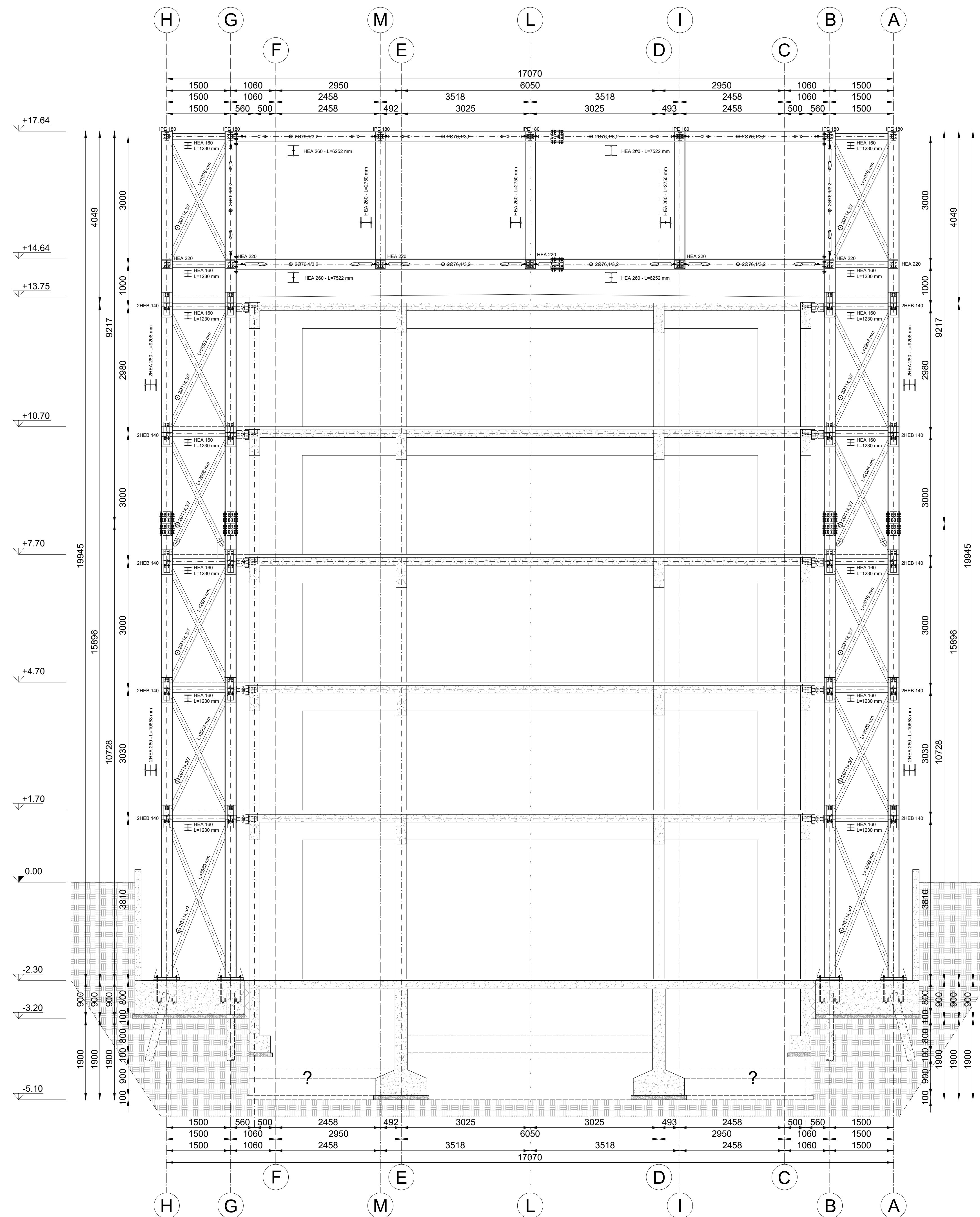
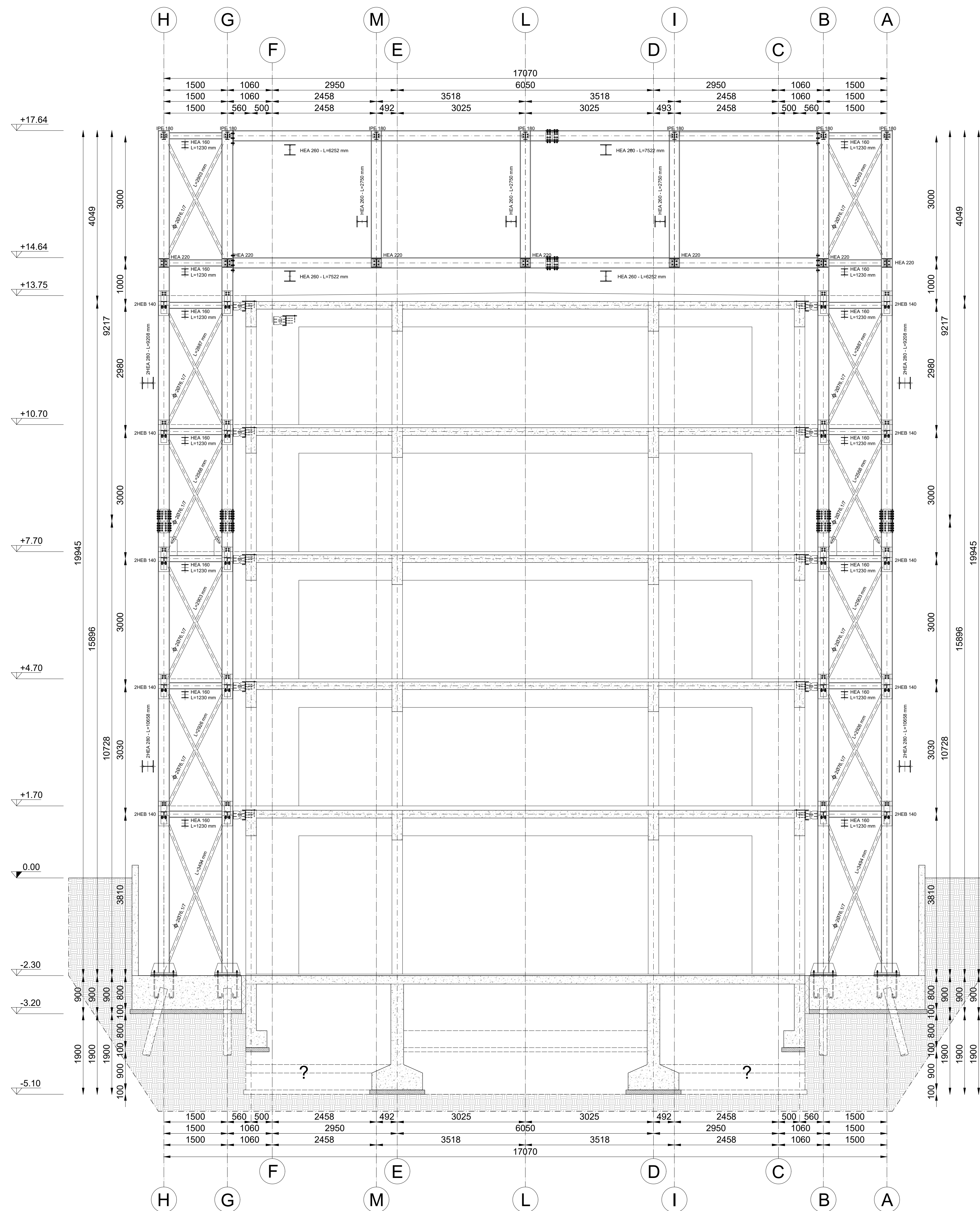

- Materials**
- Reinforced concrete existing structure**
- Concrete
 - Class C20/25
 - $f_{tk} = 2.2$ MPa
 - Rebar
 - S400
 - $f_{yk} = 400$ MPa - $f_{tk} = 500$ MPa
- Reinforced concrete new foundations**
- Concrete
 - Class C25/30
 - $f_{tk} = 2.5$ MPa
 - Rebar
 - S450C
 - $f_{yk} = 450$ MPa - $f_{tk} = 540$ MPa
 - Steel - Micropiles
 - Grade S355
 - $f_{yk} = 355$ MPa - $f_{tk} = 510$ MPa
 - Steel - GET System
 - S235 - Bracing pipe
 - $f_{yk} = 235$ MPa - $f_{tk} = 360$ MPa
 - S275 - All other profiles
 - $f_{yk} = 275$ MPa - $f_{tk} = 430$ MPa

Data from structural survey
Knowledge Level - 2
CF = 1.2

- Standards**
- Design - Verifications**
- Eurocode 2 - Basis of structural design - EN 1990 (2002)
 - Eurocode 2 - Design of concrete structures - EN 1992 (2004)
 - Eurocode 3 - Design of steel structures - EN 1993 (2005)
 - Eurocode 8 - Design of structures for earthquake resistance - Part 1: General rules, seismic actions and rules for buildings - EN 1998 (2005)
 - Eurocode 8 - Design of structures for earthquake resistance - Part 3: Assessment and retrofitting of buildings - EN 1998 (2005)
- Seismic Parameters**
- Athens - Seismic Zone I - EAK 2000 (2003)
 - Spectrum - type 1
 - Ground type - B
 - $a_{g,0.16} = 0.16$ g ($P_w = 10\%$; $T_r = 475$ years; $V_r = 50$ years)
 - $\gamma = 1.2$ - Importance factor

Notes

As reported in the manuscript, checks of the steel joints were not carried out. The connections assumed in the drawings are therefore only a typical indication dictated by the chosen assembly procedures. Foundations have not been verified due to the absence of accurate information on current foundations and on the ground. It is therefore a qualitative and oversized project (for the foundations) in order to obtain estimated quantities and costs for the project.

Annexes to the doctoral thesis entitled
On the use of the exoskeleton for seismic improvement and integrated efficient technologies in existing buildings
of the candidate
Lorenzo Badini
Alma Mater Studiorum - University of Bologna
School of Engineering and Architecture
Department of Architecture
Technical University of Munich
Department of Civil, Geo and Environmental Engineering
Chair of Timber Structures and Building Construction

Case Study:
Building FEPA at University Campus of Zografou, Athens (Greece)
Structural Drawings

Contents
Project
Vertical cross section A-A
Vertical cross section D-D
Scale 1:50

Board N°
9

Acknowledgement
Proactive synergy of integrated Efficient Technologies on buildings Envelopes. The outputs of this research are part of the Pro-GET-one project, which has received funding from the European Union's Horizon 2020 innovation action under grant agreement No 723747



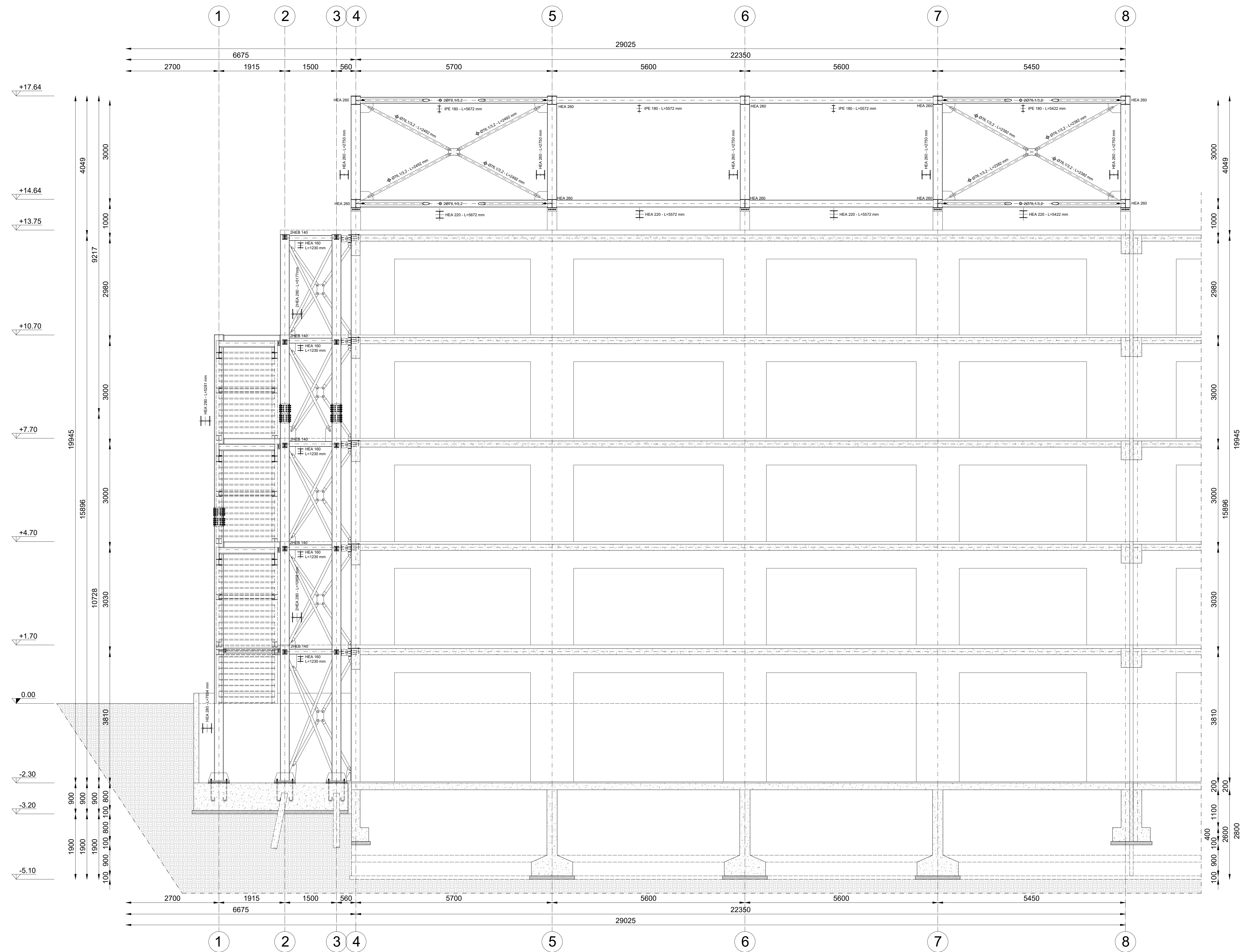

- Materials**
- Reinforced concrete existing structure**
- Concrete
 - Class C20/25
 - $f_{tk}=20.2$ MPa
 - Rebar
 - S400
 - $f_{yk}=400$ MPa - $f_{tk}=500$ MPa
- Reinforced concrete new foundations**
- Concrete
 - Class C25/30
 - $f_{tk}=25$ MPa
 - Rebar
 - B450C
 - $f_{yk}=450$ MPa - $f_{tk}=540$ MPa
 - Steel - Micropiles
 - Grade S355
 - $f_{yk}=355$ MPa - $f_{tk}=510$ MPa
 - Steel - GET System
 - S235 - Bracing pipe
 - $f_{yk}=235$ MPa - $f_{tk}=360$ MPa
 - S275 - All other profiles
 - $f_{yk}=275$ MPa - $f_{tk}=430$ MPa
- Data from structural survey
Knowledge Level - 2
CF = 1.2
- Standards**
- Design - Verifications**
- Eurocode - Basis of structural design - EN 1990 (2002)
 - Eurocode 2 - Design of concrete structures - EN 1992 (2004)
 - Eurocode 3 - Design of steel structures - EN 1993 (2005)
 - Eurocode 8 - Design of structures for earthquake resistance - Part 1: General rules, seismic actions and rules for buildings - EN 1998 (2005)
 - Eurocode 8 - Design of structures for earthquake resistance - Part 3: Assessment and retrofitting of buildings - EN 1998 (2005)
- Seismic Parameters**
- Athens - Seismic Zone I - EAK 2000 (2003)
 - Spectrum - type 1
 - Ground type - B
 - $a_g=0.16$ g ($P_{vr} = 10\%$; $T_r = 475$ years; $V_r = 50$ years)
 - $\gamma_f = 1.2$ - Importance factor

Notes

As reported in the manuscript, checks of the steel joints were not carried out. The connections assumed in the drawings are therefore only a typological indication dictated by the chosen assembly procedures. Foundations have not been verified due to the absence of accurate information on current foundations and on the ground. It is therefore a qualitative and oversized project (for the foundations) in order to obtain estimated quantities and costs for the project.

Annexes to the doctoral thesis entitled

On the use of the exoskeleton for seismic improvement and integrated efficient technologies in existing buildings

of the candidate

Lorenzo Badini

Alma Mater Studiorum - University of Bologna
School of Engineering and Architecture
Department of Architecture

Technical University of Munich
Department of Civil, Geo and Environmental Engineering
Chair of Timber Structures and Building Construction

Case Study:

Building FEPA at University Campus of Zografou, Athens (Greece)
Structural Drawings

Contents

Project
Vertical cross section B-B
Scale 1:50

Board N°
10

Acknowledgement

Proactive synergy of inteGrated Efficient Technologies on buildings Envelopes. The outputs of this research are part of the Pro-GET-onE project, which has received funding from the European Union's Horizon 2020 Innovation action under grand agreement No 723747

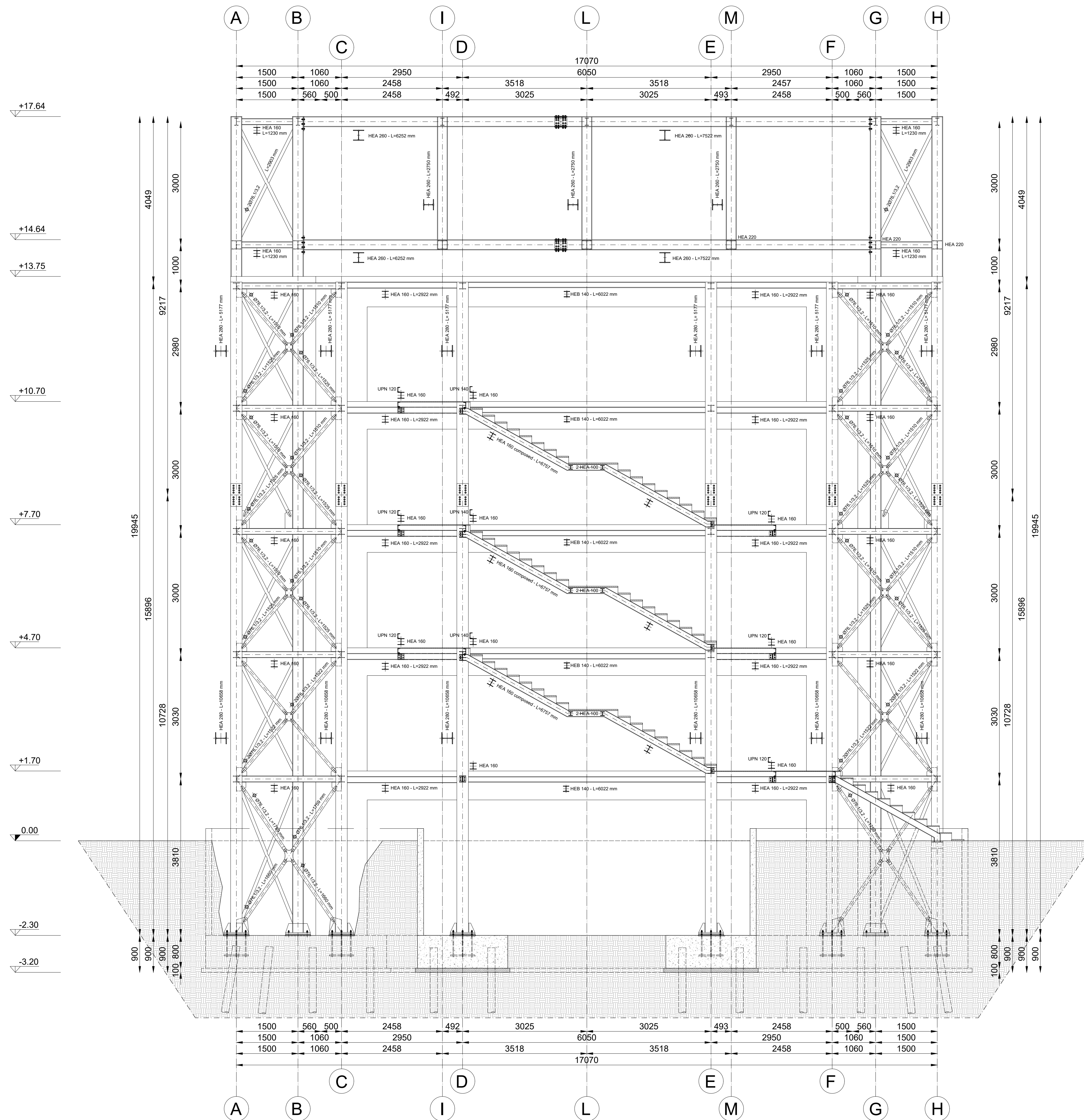

Materials

Reinforced concrete existing structure

Concrete
 - Class C20/25
 $f_{ck}=20.2 \text{ MPa}$

Rebar
 - S400
 $f_{yk}=400 \text{ MPa}$ - $f_{tk}=500 \text{ MPa}$

Reinforced concrete new foundations

Concrete
 - Class C25/30
 $f_{ck}=25 \text{ MPa}$

Rebar
 - B450C
 $f_{yk}=450 \text{ MPa}$ - $f_{tk}=540 \text{ MPa}$

Steel - Micropiles
 - Grade S355
 $f_{yk}=355 \text{ MPa}$ - $f_{tk}=510 \text{ MPa}$

Steel - GET System

S235 - Bracing pipe
 $f_{yk}=235 \text{ MPa}$ - $f_{tk}=360 \text{ MPa}$

S275 - All other profiles
 $f_{yk}=275 \text{ MPa}$ - $f_{tk}=430 \text{ MPa}$

Data from structural survey
 Knowledge Level - 2

CF = 1.2

Standards

Design - Verifications

- Eurocode - Basis of structural design - EN 1990 (2002)
- Eurocode 2 - Design of concrete structures - EN 1992 (2004)
- Eurocode 3 - Design of steel structures - EN 1993 (2005)
- Eurocode 8 - Design of structures for earthquake resistance - Part 1: General rules, seismic actions and rules for buildings - EN 1998 (2005)
- Eurocode 8 - Design of structures for earthquake resistance - Part 3: Assessment and retrofitting of buildings - EN 1998 (2005)

Seismic Parameters

- Athens - Seismic Zone I - EAK 2000 (2003)
- Spectrum - type 1
- Ground type - B
- $a_g=0.16 \text{ g}$ ($P_{vr} = 10\%$; $T_r = 475 \text{ years}$; $V_r = 50 \text{ years}$)
- $\gamma_i = 1.2$ - Importance factor

Notes

As reported in the manuscript, checks of the steel joints were not carried out. The connections assumed in the drawings are therefore only a typological indication dictated by the chosen assembly procedures. Foundations have not been verified due to the absence of accurate information on current foundations and on the ground. It is therefore a qualitative and oversized project (for the foundations) in order to obtain estimated quantities and costs for the project.

Annexes to the doctoral thesis entitled

On the use of the exoskeleton for seismic improvement and integrated efficient technologies in existing buildings

of the candidate

Lorenzo Badini

Alma Mater Studiorum - University of Bologna
 School of Engineering and Architecture
 Department of Architecture

Technical University of Munich
 Department of Civil, Geo and Environmental Engineering
 Chair of Timber Structures and Building Construction

Case Study:

Building FEPA at University Campus of Zografou, Athens (Greece)
 Structural Drawings

Contents

Project
 Vertical cross section C-C
 Scale 1:50

Board N°

11

Acknowledgement

Proactive synergy of inteGrated Efficient Technologies on buildings Envelopes. The outputs of this research are part of the Pro-GET-on-E project, which has received funding from the European Union's Horizon 2020 Innovation action under grand agreement No 723747



Materials

Reinforced concrete existing structure

- Concrete
 - Class C20/25
 - $f_{tk}=20.2$ MPa
- Rebar
 - S400
 - $f_{yk}=400$ MPa - $f_{tk}=500$ MPa

Data from structural survey
Knowledge Level - 2

CF = 1.2

Reinforced concrete new foundations

- Concrete
 - Class C25/30
 - $f_{tk}=25$ MPa
- Rebar
 - B450C
 - $f_{yk}=450$ MPa - $f_{tk}=540$ MPa

Steel - Micropiles

- Grade S355
- $f_{yk}=355$ MPa - $f_{tk}=510$ MPa

Steel - GET System

- S235 - Bracing pipe
 - $f_{yk}=235$ MPa - $f_{tk}=360$ MPa

S275 - All other profiles

- $f_{yk}=275$ MPa - $f_{tk}=430$ MPa

Standards

Design - Verifications

- Eurocode - Basis of structural design - EN 1990 (2002)
- Eurocode 2 - Design of concrete structures - EN 1992 (2004)
- Eurocode 3 - Design of steel structures - EN 1993 (2005)
- Eurocode 8 - Design of structures for earthquake resistance - Part 1: General rules, seismic actions and rules for buildings - EN 1998 (2005)
- Eurocode 8 - Design of structures for earthquake resistance - Part 3: Assessment and retrofitting of buildings - EN 1998 (2005)

Seismic Parameters

- Athens - Seismic Zone I - EAK 2000 (2003)
- Spectrum - type 1
- Ground type - B
- $a_g=0.16$ g ($P_{ov} = 10\%$; $T_r = 475$ years; $V_r = 50$ years)
- $\gamma_f = 1.2$ - Importance factor

Notes

As reported in the manuscript, checks of the steel joints were not carried out. The connections assumed in the drawings are therefore only a typological indication dictated by the chosen assembly procedures. Foundations have not been verified due to the absence of accurate information on current foundations and on the ground. It is therefore a qualitative and oversized project (for the foundations) in order to obtain estimated quantities and costs for the project.

Annexes to the doctoral thesis entitled

On the use of the exoskeleton for seismic improvement and integrated efficient technologies in existing buildings

of the candidate

Lorenzo Badini

Alma Mater Studiorum - University of Bologna
School of Engineering and Architecture
Department of Architecture

Technical University of Munich
Department of Civil, Geo and Environmental Engineering
Chair of Timber Structures and Building Construction

Case Study:

Building FEPA at University Campus of Zografou, Athens (Greece)
Structural Drawings

Contents

Project
Vertical cross section E-E
Scale 1:50

Board N°

12

Acknowledgement

Proactive synergy of inteGrated Efficient Technologies on buildings Envelopes. The outputs of this research are part of the Pro-GET-onE project, which has received funding from the European Union's Horizon 2020 Innovation action under grand agreement No 723747

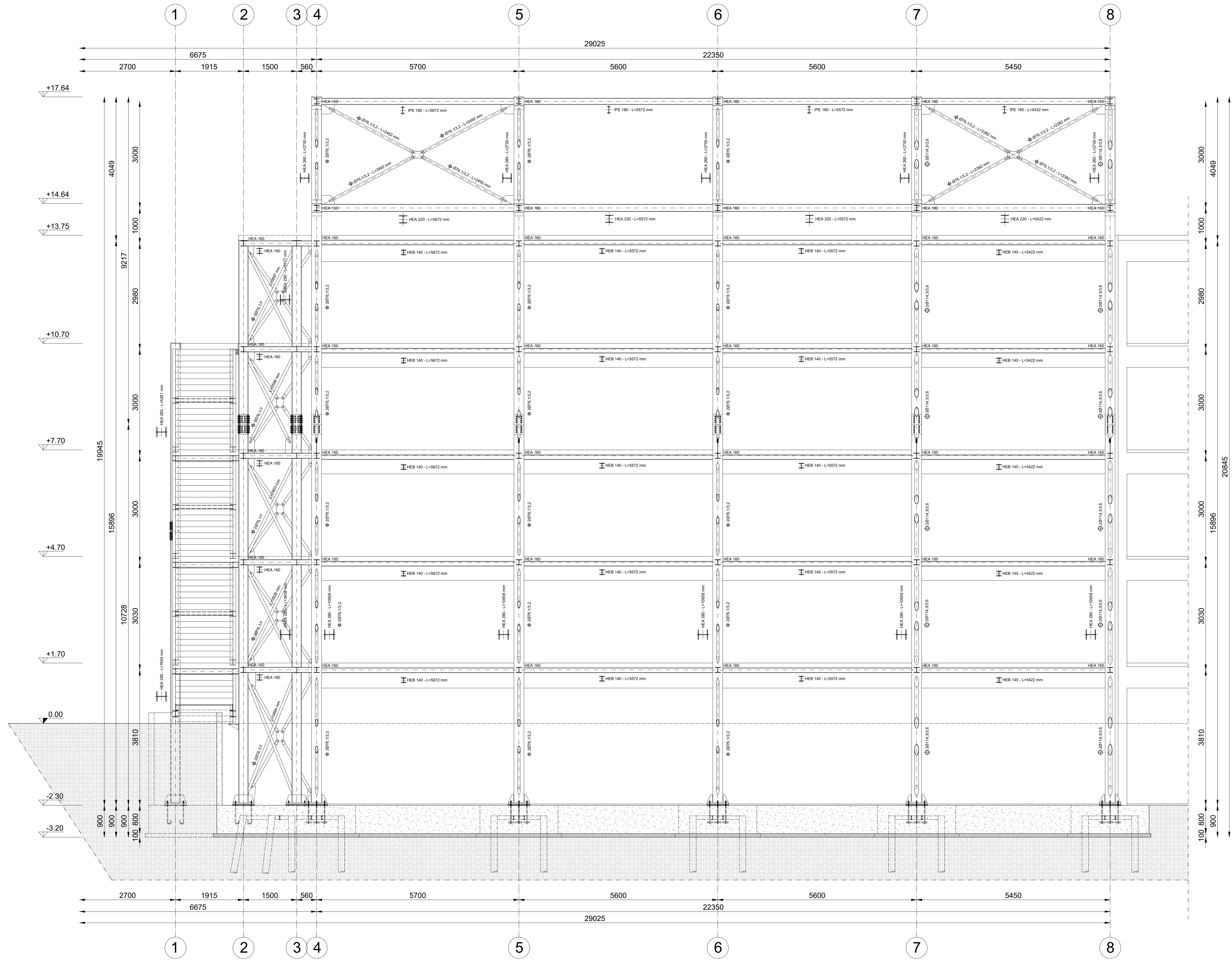

PTT2 - CLT Spruce

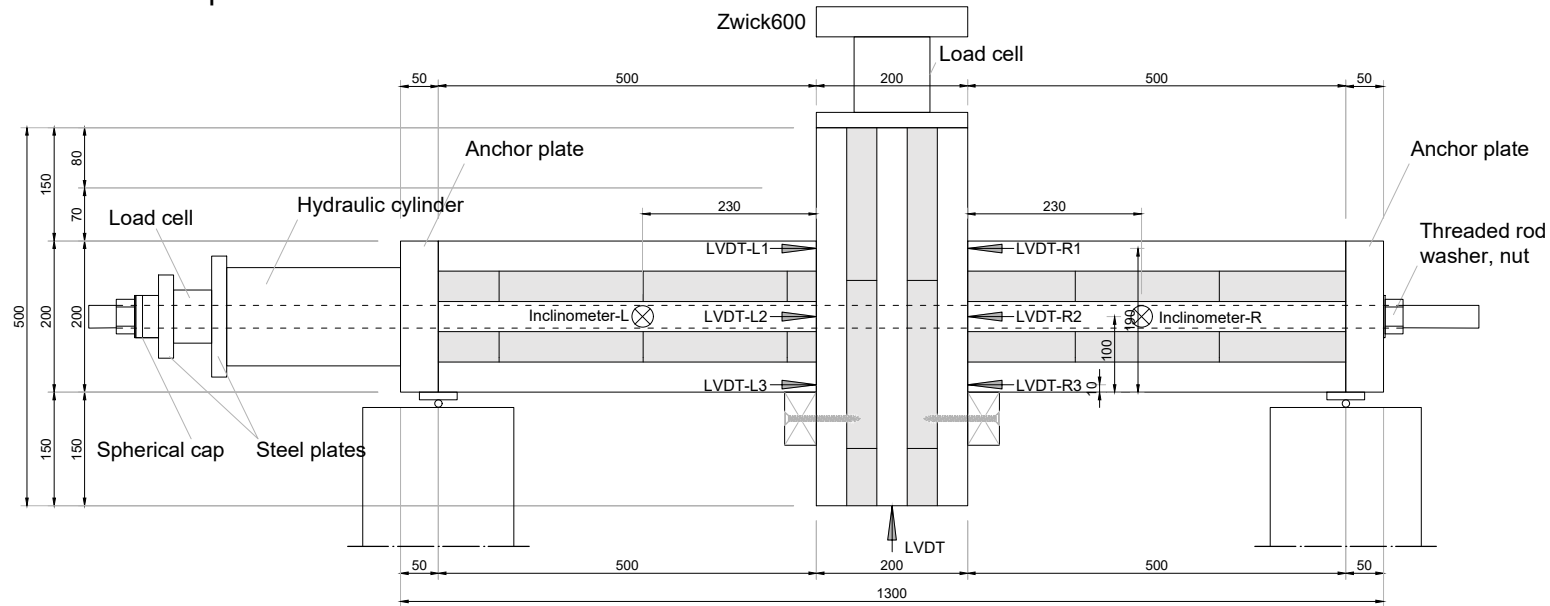

2x Horizontal CLT elements (C24)

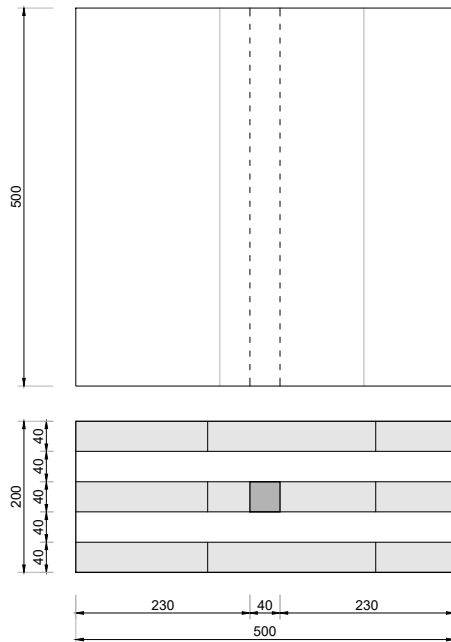

Vertical CLT element (C24)

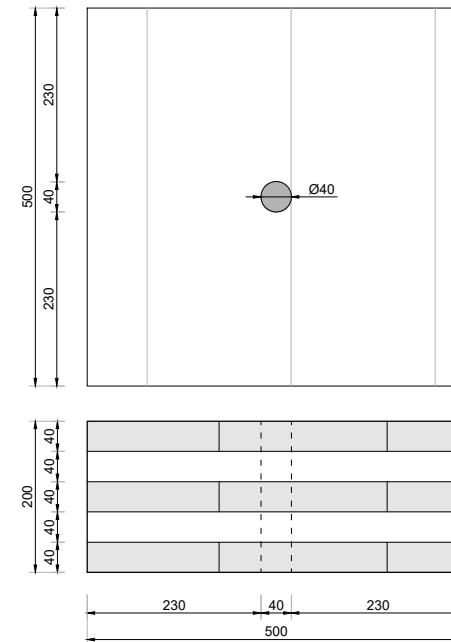

PTT3 - LVL R

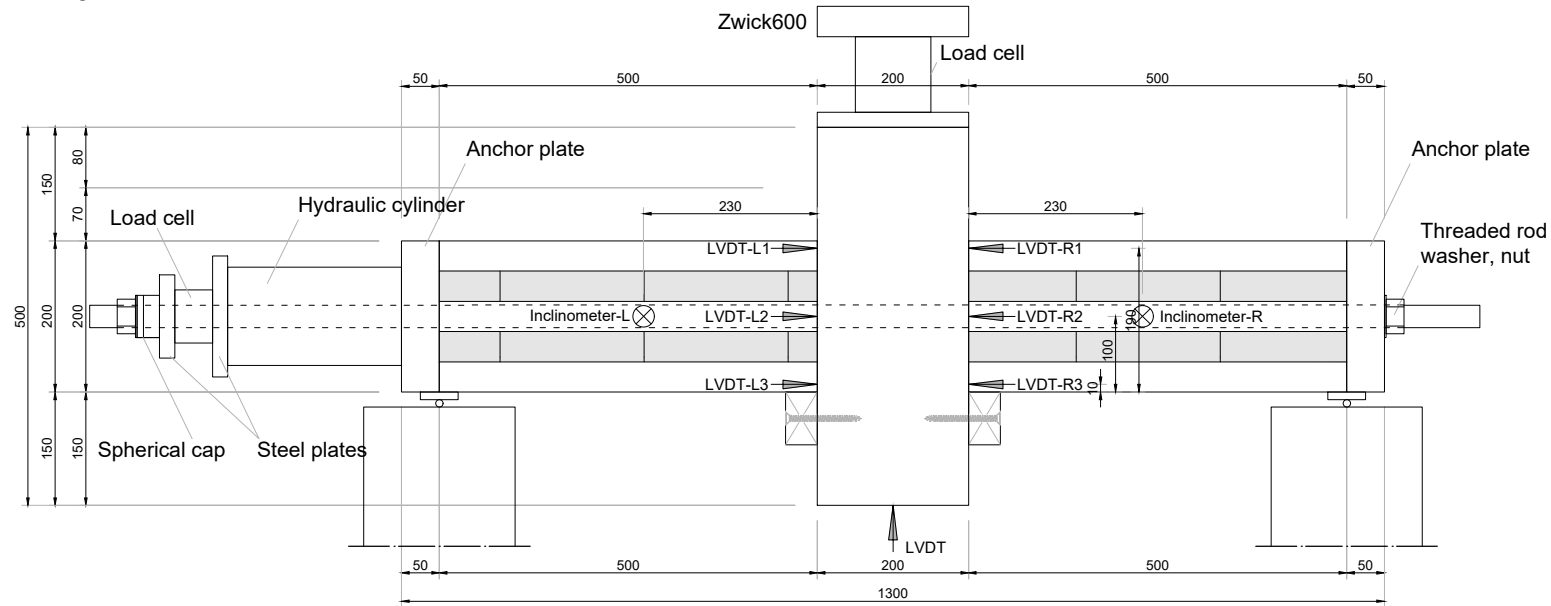

2x Horizontal CLT elements (C24)

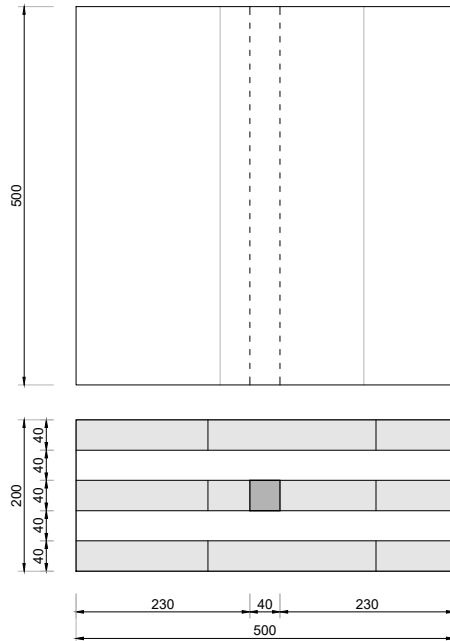

Vertical LVL-R element (C24)

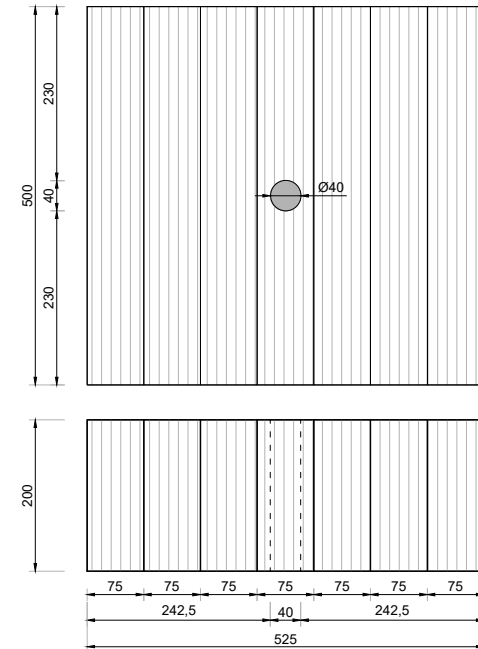

PTT4 - CLT Spruce with steel plates

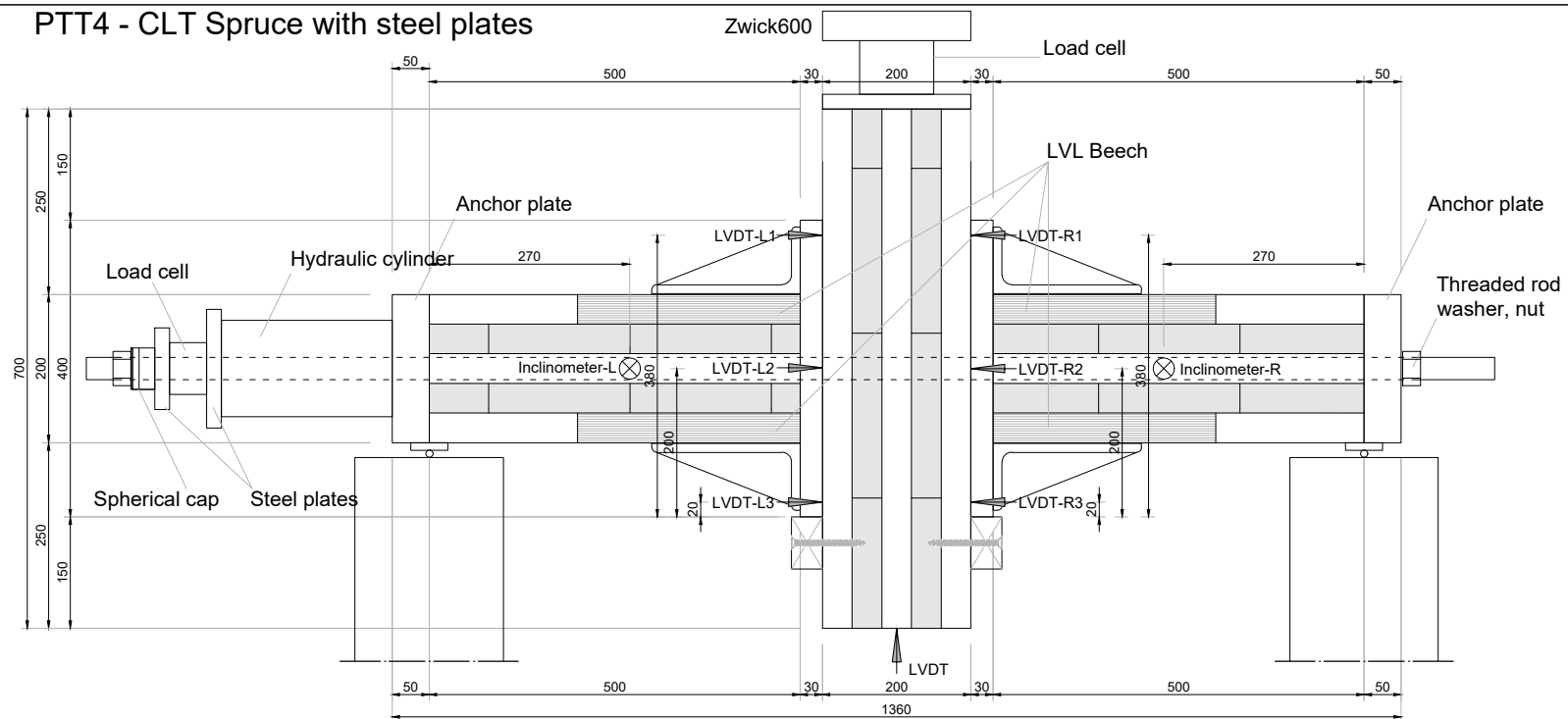

2x Horizontal reinforced CLT elements (C24)

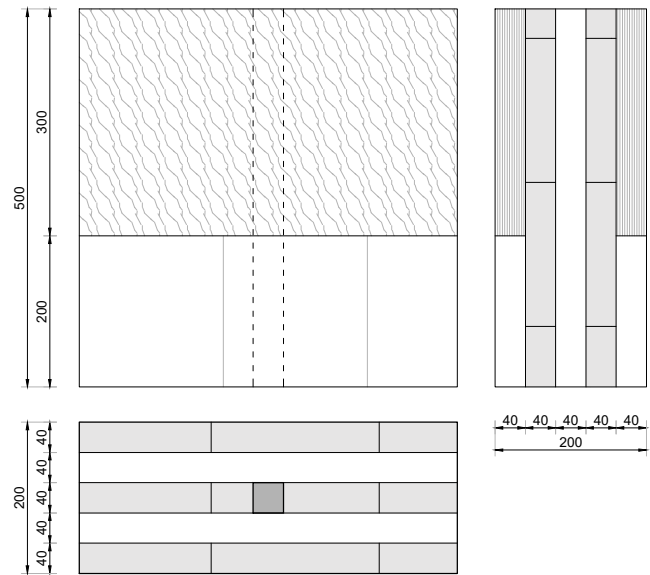

LVL - Beech

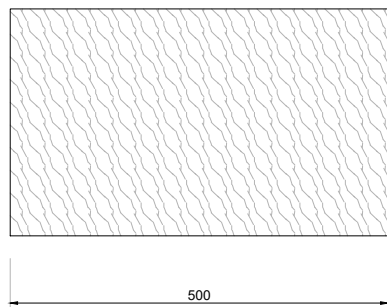

Vertical CLT elements (C24)

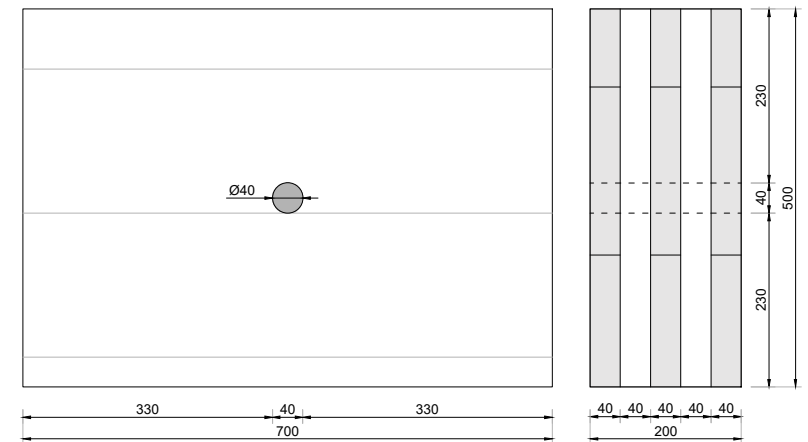

PTT5 - LVL R with steel plates

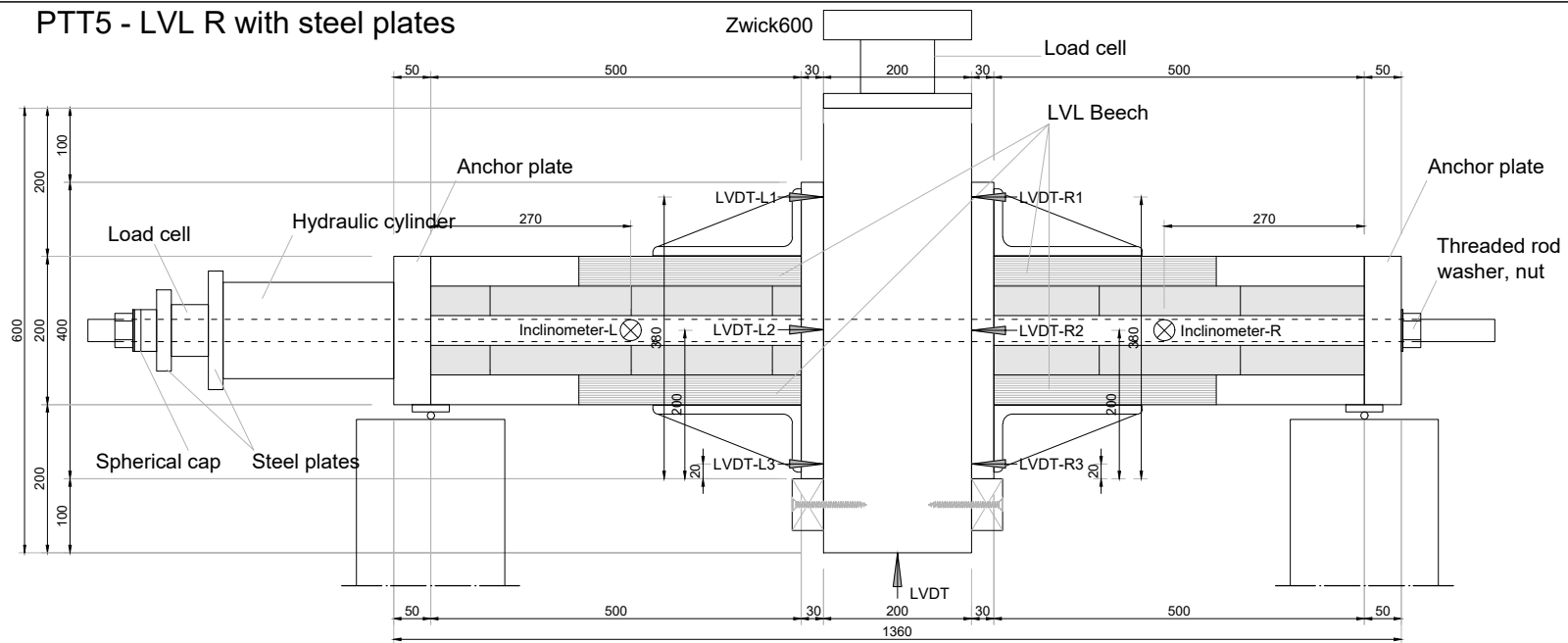

2x Horizontal reinforced CLT elements (C24)

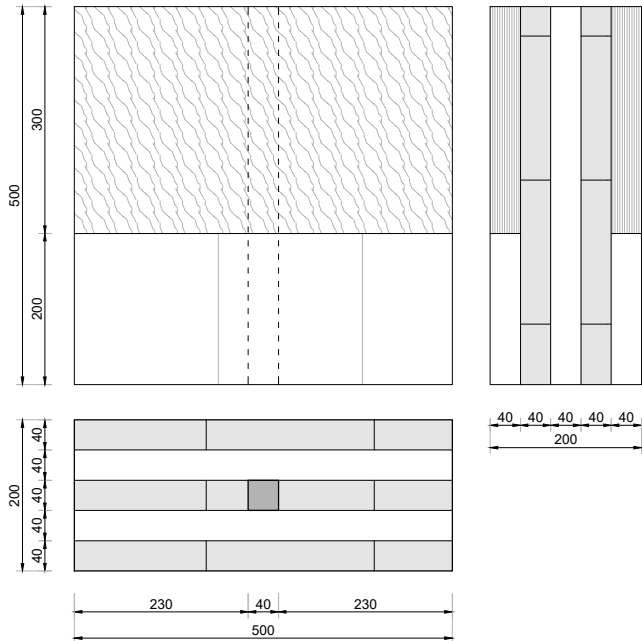

LVL - Beech

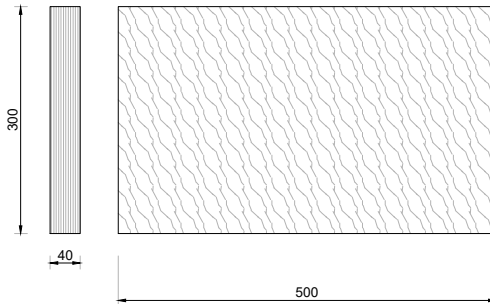

Vertical LVL elements (C24)

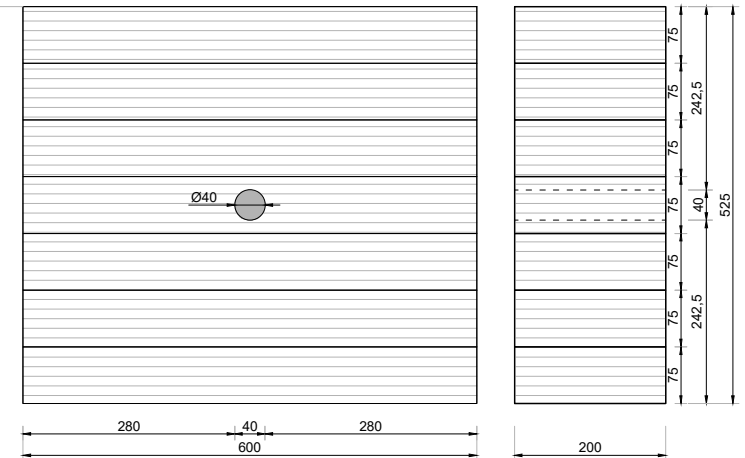

2x Composite steel connection plate (S235)

Steel plate for connection (S235)

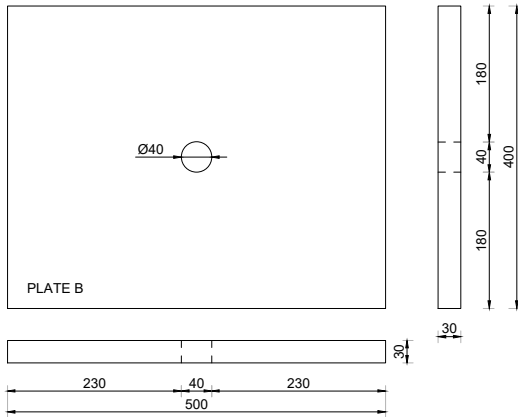

Welded profiles (S235):
4 steel 200x90x12 L-profiles
Length 500mm

2x Steel anchor plate (S235)

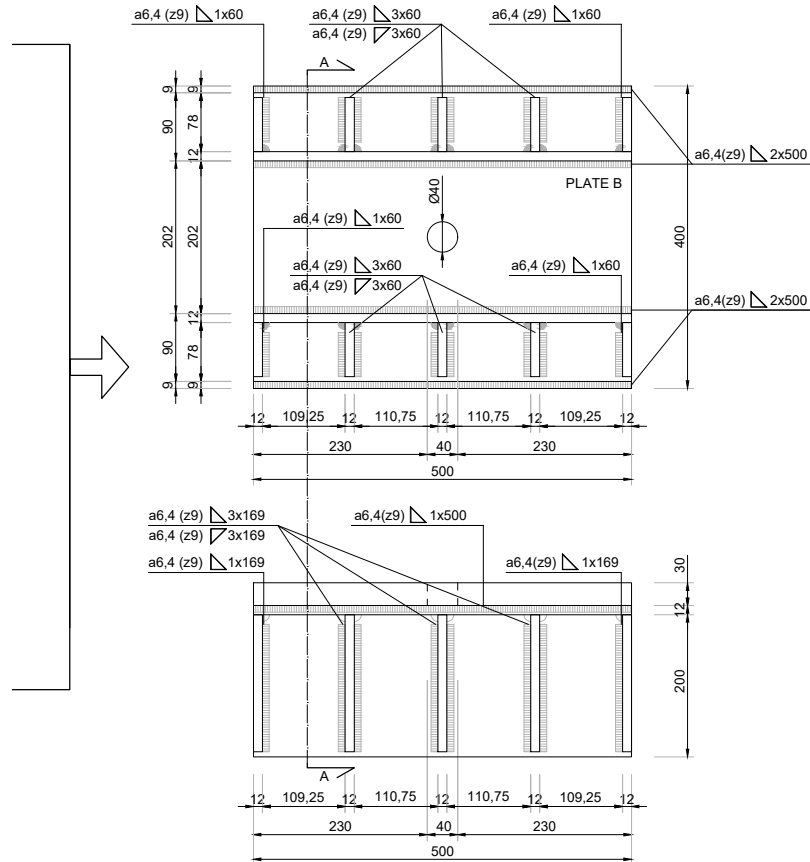
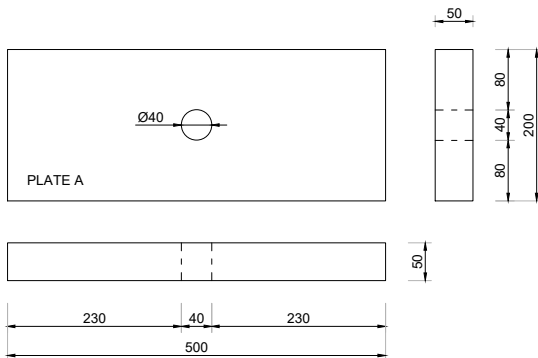

Cross-section A-A

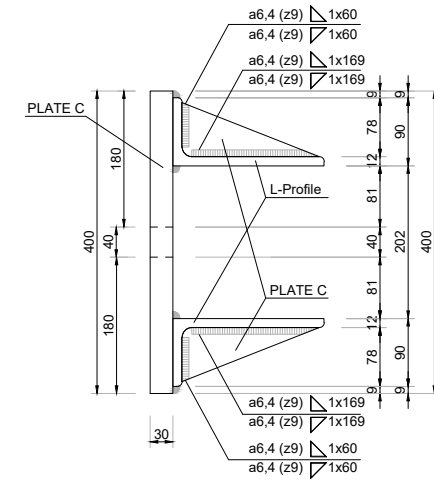

20 steel stiffening plates (S235)
Thickness 12mm

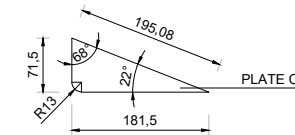

Steel threaded rod M30 (8.8)

$$A_{res} = 561 \text{ mm}^2$$

$$F_p = 337 \text{ kN}$$

$$F_{m,min} = 466 \text{ kN}$$

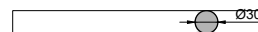

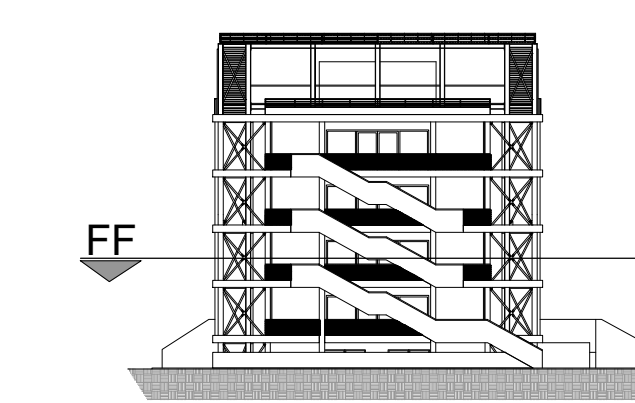
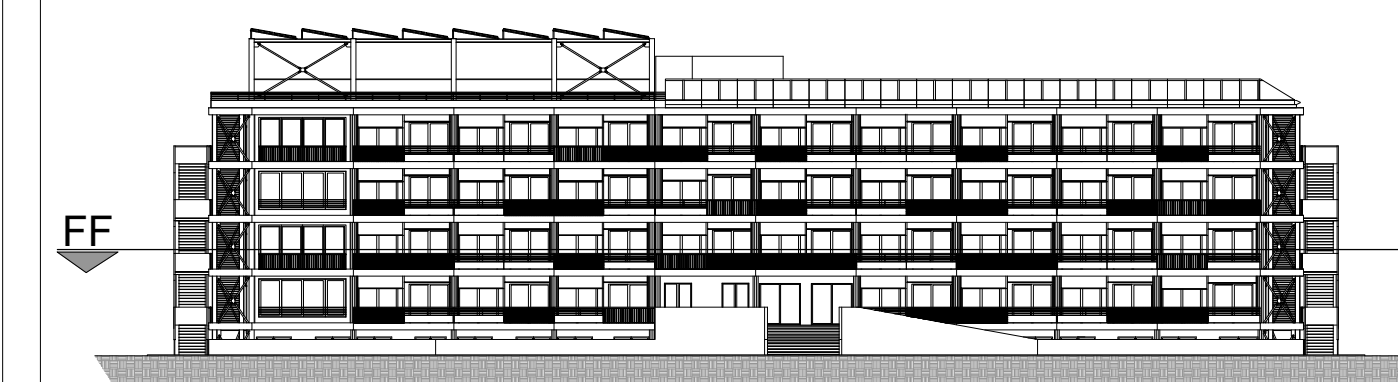

Acknowledgement

Proactive synergy of inteGrated Efficient Technologies on buildings Envelopes. The outputs of this research are part of the Pro-GET-onE project, which has received funding from the European Union's Horizon 2020 Innovation action under grand agreement No 723747



Annexes to the doctoral thesis entitled

On the use of the exoskeleton for seismic improvement and integrated efficient technologies in existing buildings

of the candidate

Lorenzo Badini

Alma Mater Studiorum - University of Bologna
School of Engineering and Architecture
Department of Architecture

Technical University of Munich
Department of Civil, Geo and Environmental Engineering
Chair of Timber Structures and Building Construction

Case Study:

Building FEPA at University Campus of Zografou, Athens (Greece)

Contents

First Floor
Scale 1:50

Board N°

2



FIRST FLOOR



Positioning on façade views

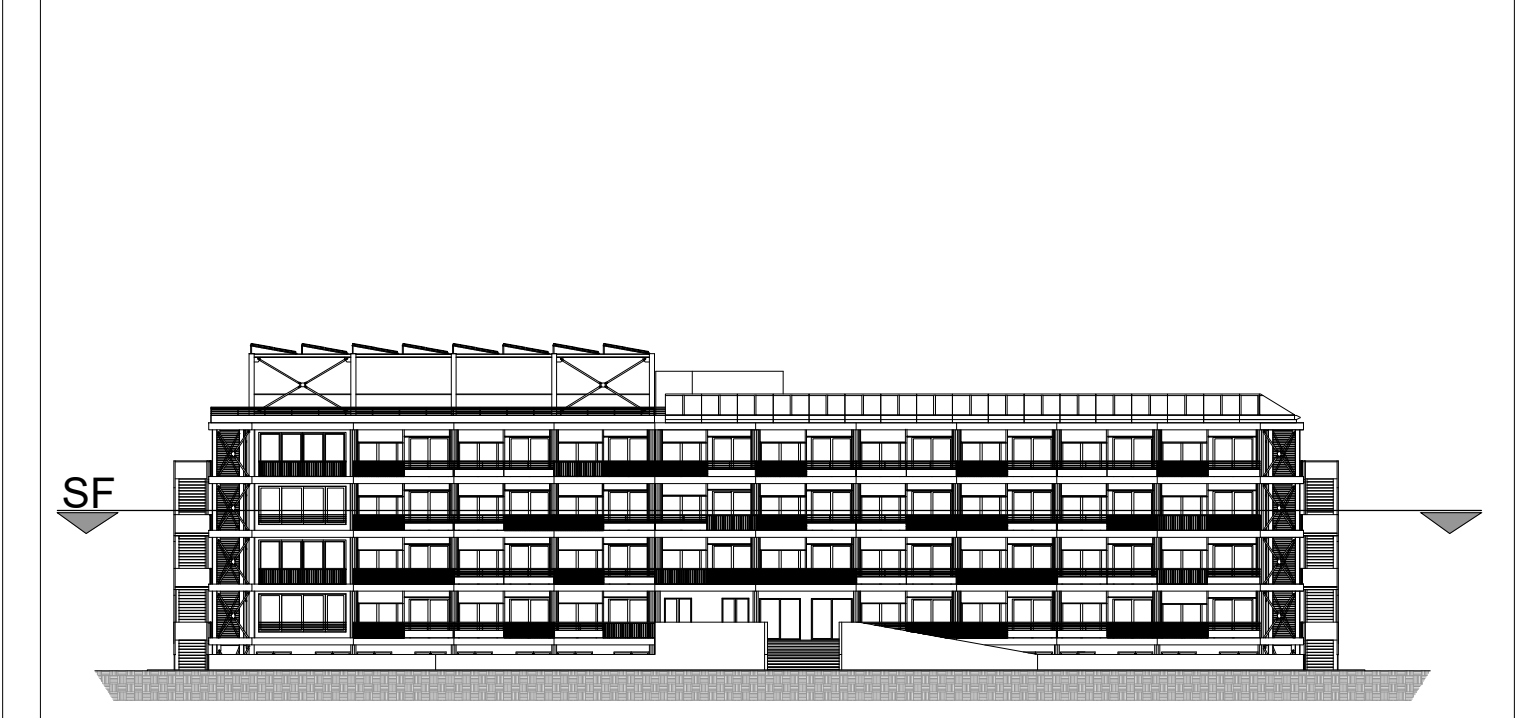

Acknowledgement
 Proactive synergy of inteGrated Efficient Technologies on buildings Envelopes. The outputs of this research are part of the Pro-GET-on-E project, which has received funding from the European Union's Horizon 2020 Innovation action under grant agreement No 723747



Annexes to the doctoral thesis entitled
On the use of the exoskeleton for seismic improvement and integrated efficient technologies in existing buildings
 of the candidate
Lorenzo Badini

Alma Mater Studiorum - University of Bologna
 School of Engineering and Architecture
 Department of Architecture
 Technical University of Munich
 Department of Civil, Geo and Environmental Engineering
 Chair of Timber Structures and Building Construction

Case Study:
 Building FEPA at University Campus of Zografou, Athens (Greece)

Contents	Board N°
Second Floor Scale 1:50	3



Positioning on façade views

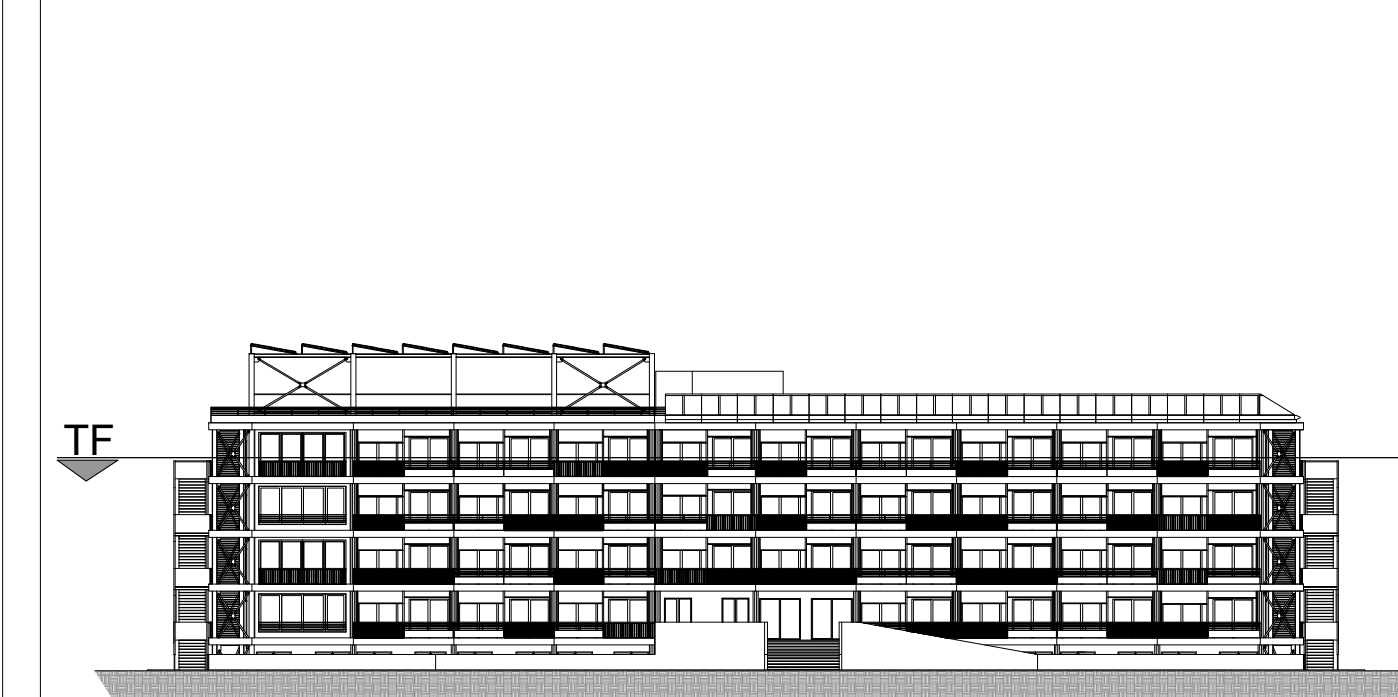

Acknowledgement

Proactive synergy of integrated Efficient Technologies on buildings Envelopes. The outputs of this research are part of the Pro-GET-on-E project, which has received funding from the European Union's Horizon 2020 Innovation action under grant agreement No 723747



Annexes to the doctoral thesis entitled

On the use of the exoskeleton for seismic improvement and integrated efficient technologies in existing buildings

of the candidate

Lorenzo Badini

Alma Mater Studiorum - University of Bologna
School of Engineering and Architecture
Department of Architecture

Technical University of Munich
Department of Civil, Geo and Environmental Engineering
Chair of Timber Structures and Building Construction

Case Study:

Building FEPA at University Campus of Zografou, Athens (Greece)

Contents

Third Floor
Scale 1:50

Board N°

4



Positioning on façade views

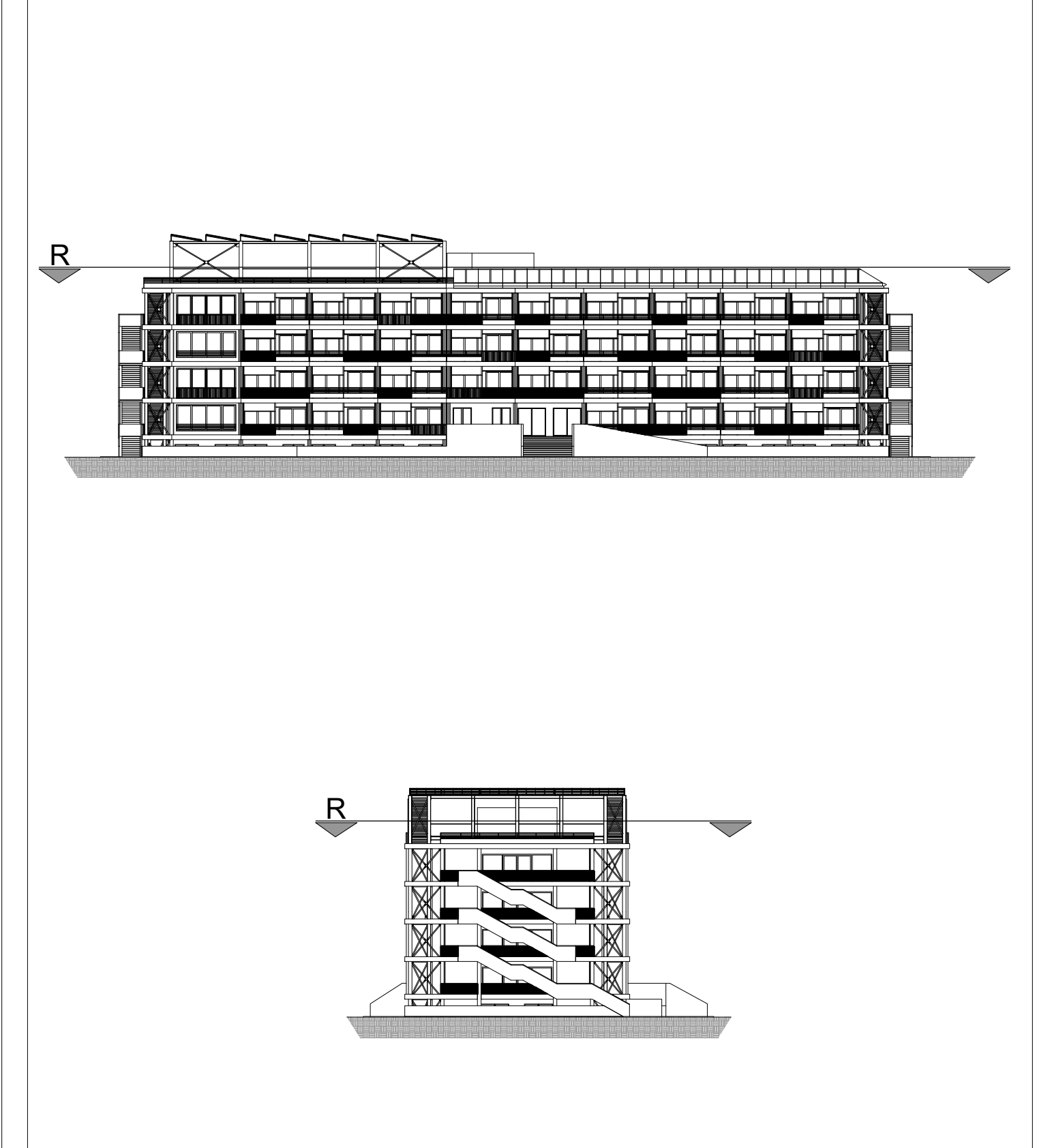

Acknowledgement
 Proactive synergy of inteGrated Efficient Technologies on buildings Envelopes. The outputs of this research are part of the Pro-GET-onE project, which has received funding from the European Union's Horizon 2020 Innovation action under grand agreement No 723747



Annexes to the doctoral thesis entitled
On the use of the exoskeleton for seismic improvement and integrated efficient technologies in existing buildings
 of the candidate
Lorenzo Badini

Alma Mater Studiorum - University of Bologna
 School of Engineering and Architecture
 Department of Architecture
 Technical University of Munich
 Department of Civil, Geo and Environmental Engineering
 Chair of Timber Structures and Building Construction

Case Study:
 Building FEPA at University Campus of Zografou, Athens (Greece)

Contents	Board N°
Roof Scale 1:50	5



Positioning on façade views

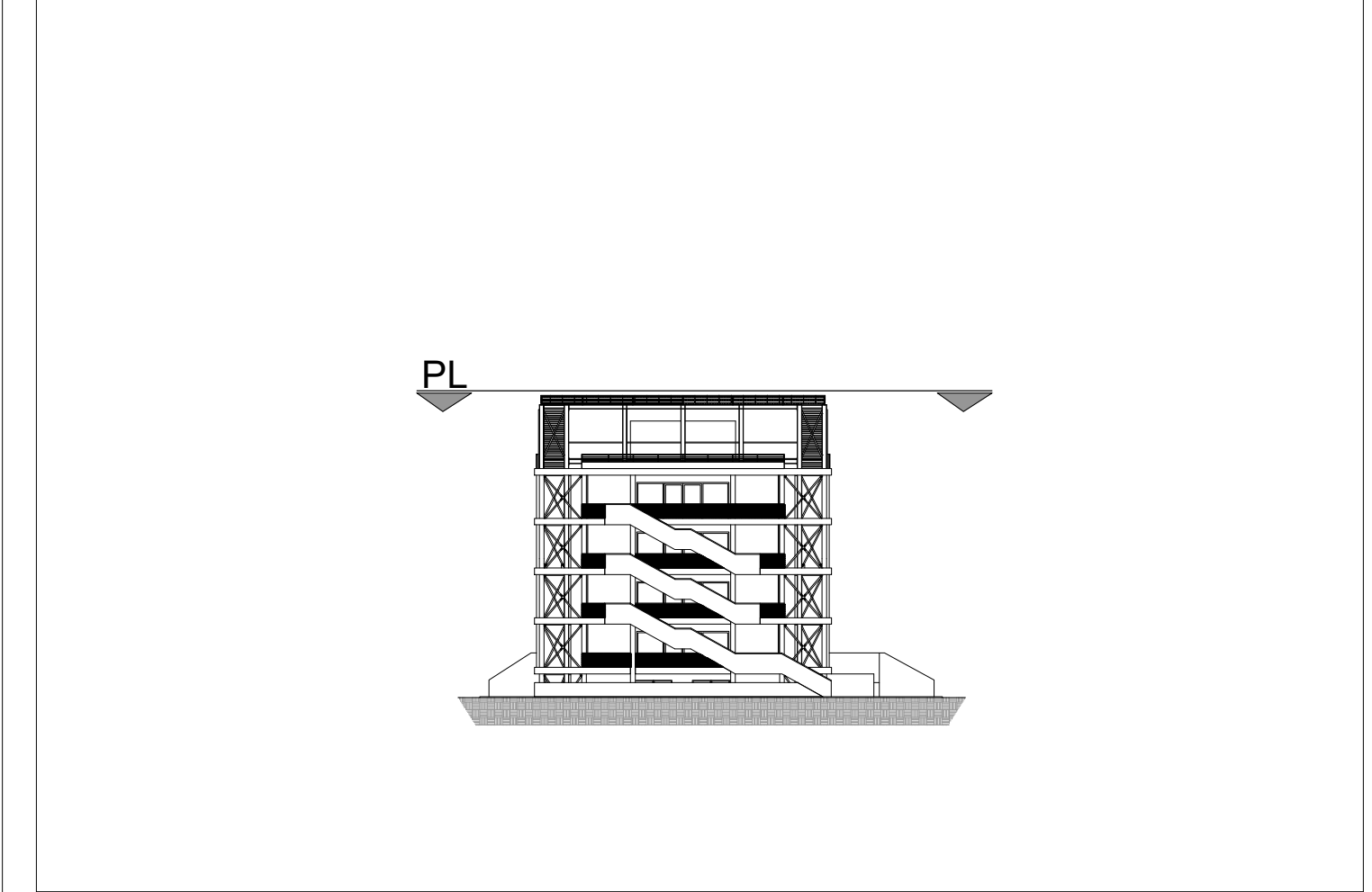
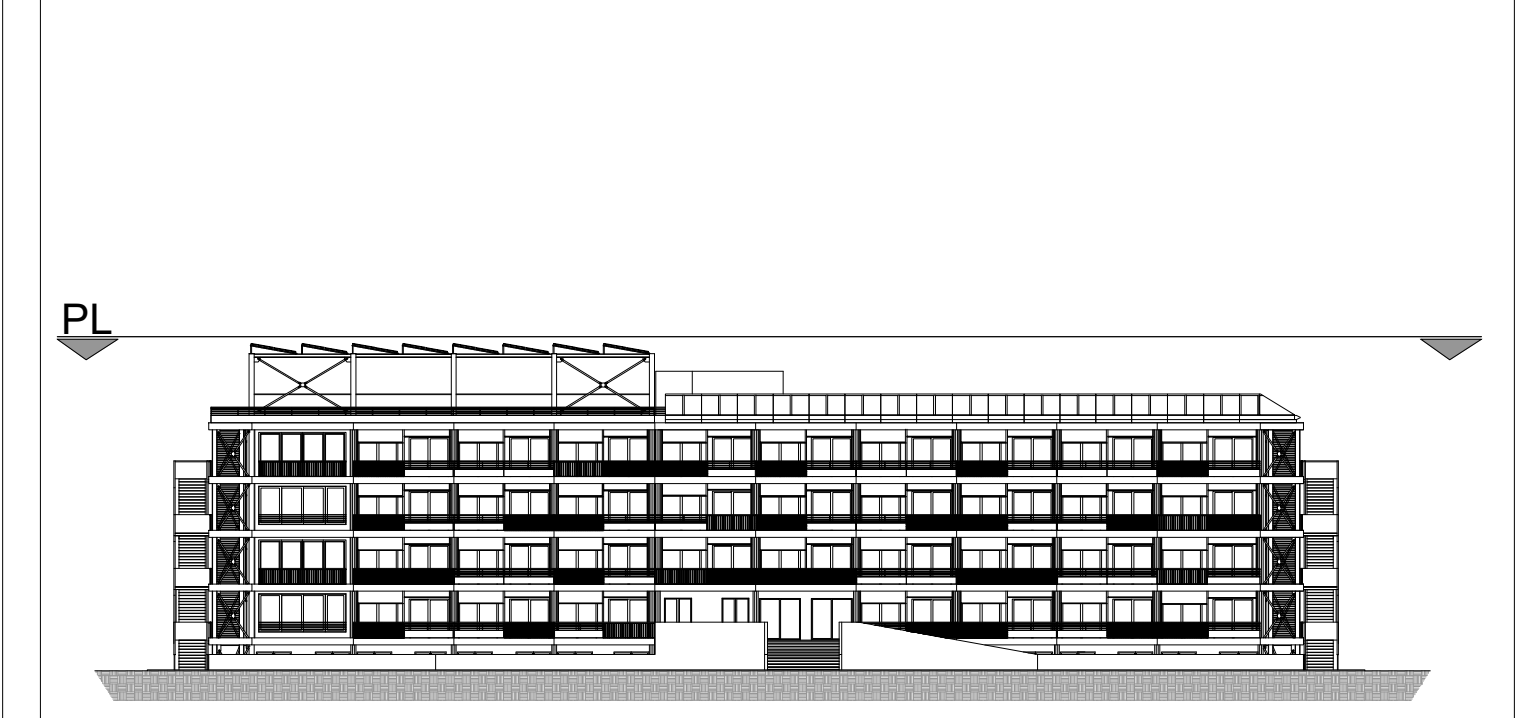

Acknowledgement
 Proactive synergy of inteGrated Efficient Technologies on buildings Envelopes. The outputs of this research are part of the Pro-GET-on-E project, which has received funding from the European Union's Horizon 2020 Innovation action under grand agreement No 723747

Annexes to the doctoral thesis entitled
On the use of the exoskeleton for seismic improvement and integrated efficient technologies in existing buildings
 of the candidate
Lorenzo Badini

Alma Mater Studiorum - University of Bologna
 School of Engineering and Architecture
 Department of Architecture
Technical University of Munich
 Department of Civil, Geo and Environmental Engineering
 Chair of Timber Structures and Building Construction

Case Study:
 Building FEPA at University Campus of Zografou, Athens (Greece)

Contents	Board N°
Rooftop Scale 1:50	6



NORTH-WEST FAÇADE

Positioning on planimetric views

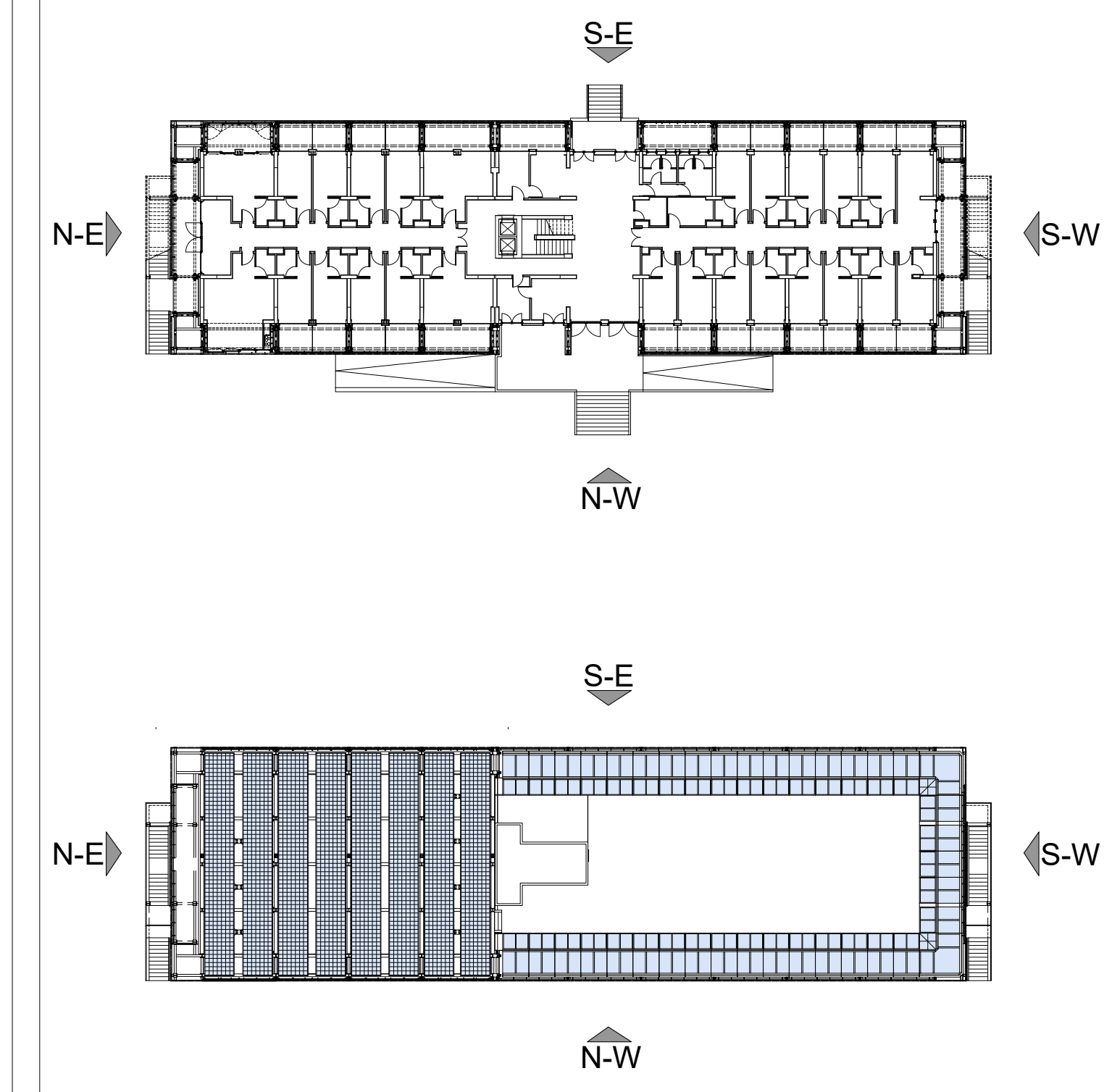

Acknowledgement

Proactive synergy of integrated Efficient Technologies on buildings Envelopes. The outputs of this research are part of the Pro-GET-onE project, which has received funding from the European Union's Horizon 2020 Innovation action under grant agreement No 723747



Annexes to the doctoral thesis entitled

On the use of the exoskeleton for seismic improvement and integrated efficient technologies in existing buildings

of the candidate

Lorenzo Badini

Alma Mater Studiorum - University of Bologna
School of Engineering and Architecture
Department of Architecture

Technical University of Munich
Department of Civil, Geo and Environmental Engineering
Chair of Timber Structures and Building Construction

Case Study:

Building FEPA at University Campus of Zografou, Athens (Greece)

Contents

North-West Façade
Scale 1:50

Board N°

7



SOUTH-EAST FAÇADE

Positioning on planimetric views

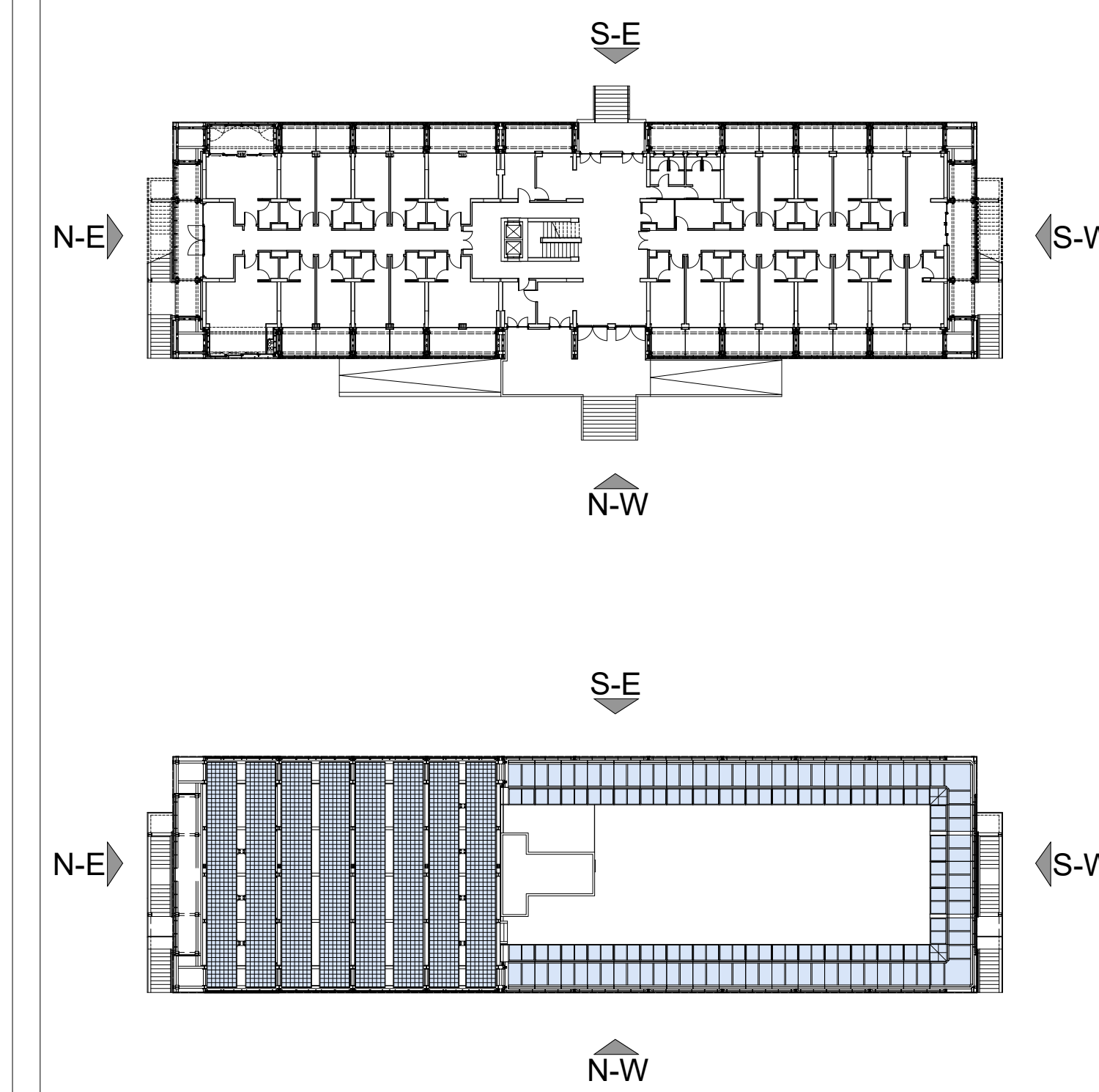

Acknowledgement

Proactive synergy of integrated Efficient Technologies on buildings Envelopes. The outputs of this research are part of the Pro-GET-onE project, which has received funding from the European Union's Horizon 2020 Innovation action under grant agreement No 723747



Annexes to the doctoral thesis entitled

On the use of the exoskeleton for seismic improvement and integrated efficient technologies in existing buildings

of the candidate

Lorenzo Badini

Alma Mater Studiorum - University of Bologna
School of Engineering and Architecture
Department of Architecture

Technical University of Munich
Department of Civil, Geo and Environmental Engineering
Chair of Timber Structures and Building Construction

Case Study:

Building FEPA at University Campus of Zografou, Athens (Greece)

Contents

South-East Façade
Scale 1:50

Board N°

8

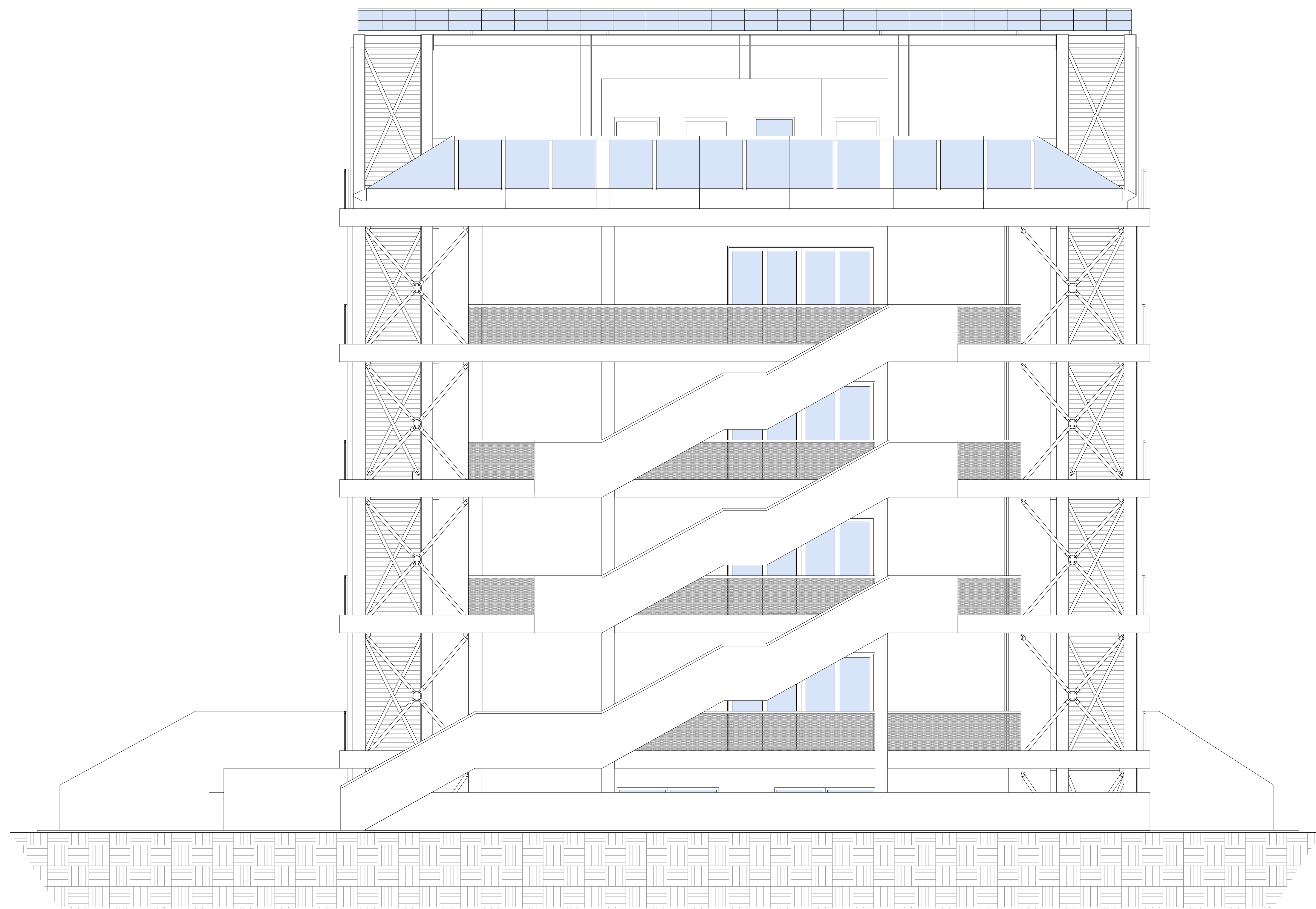

SOUTH-WEST FAÇADE

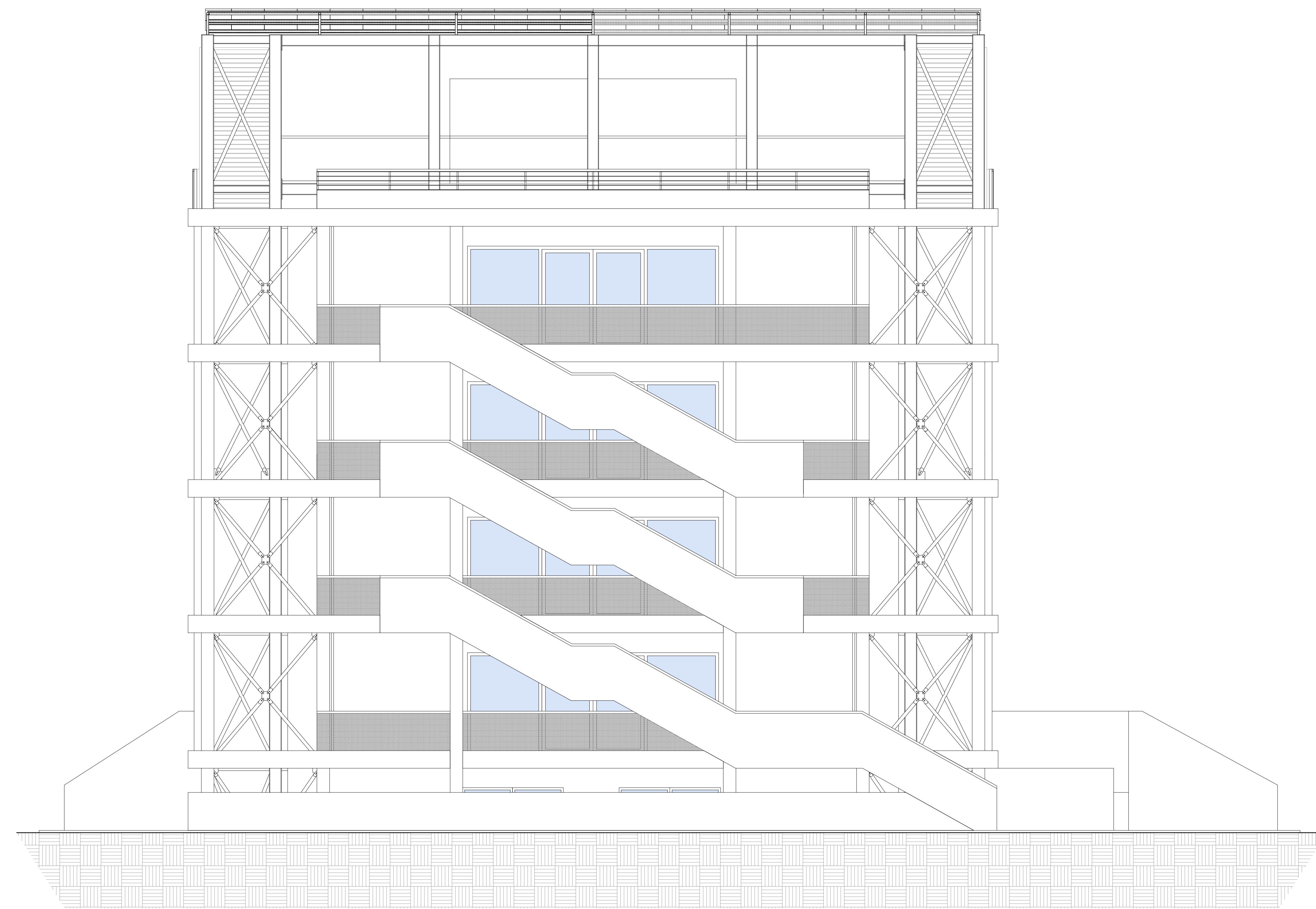

NORTH-EAST FAÇADE

Positioning on planimetric views

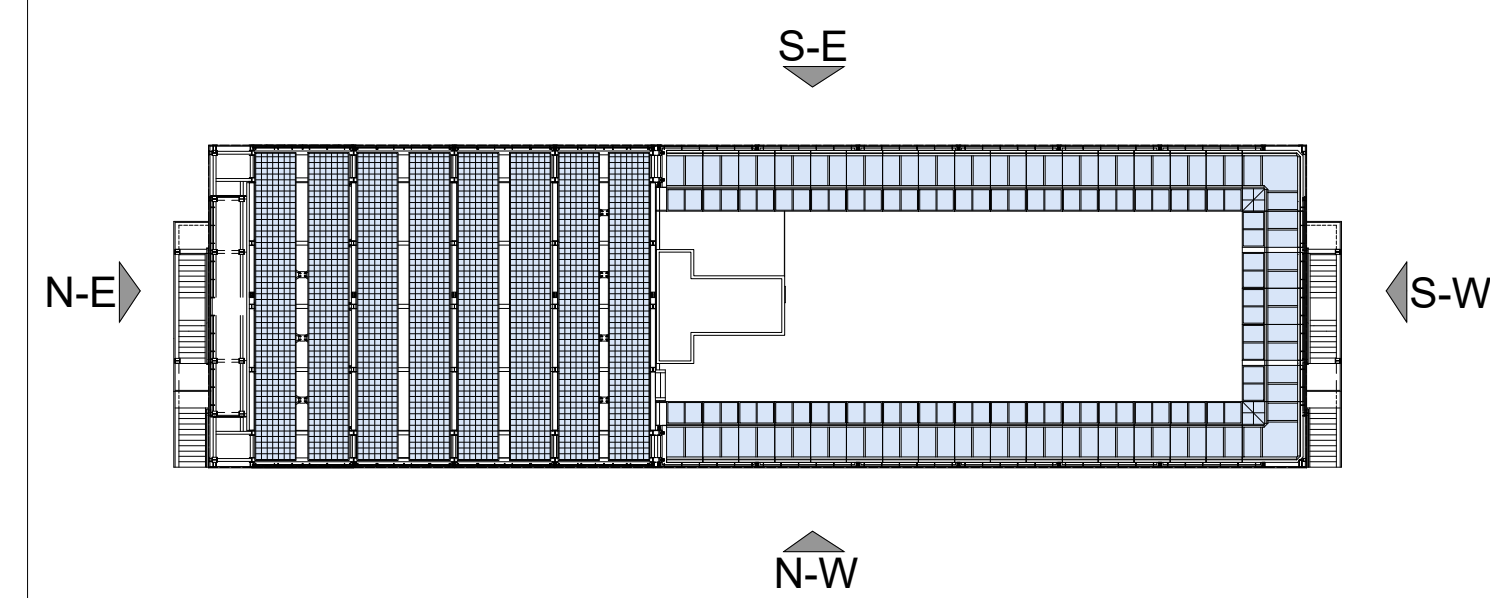
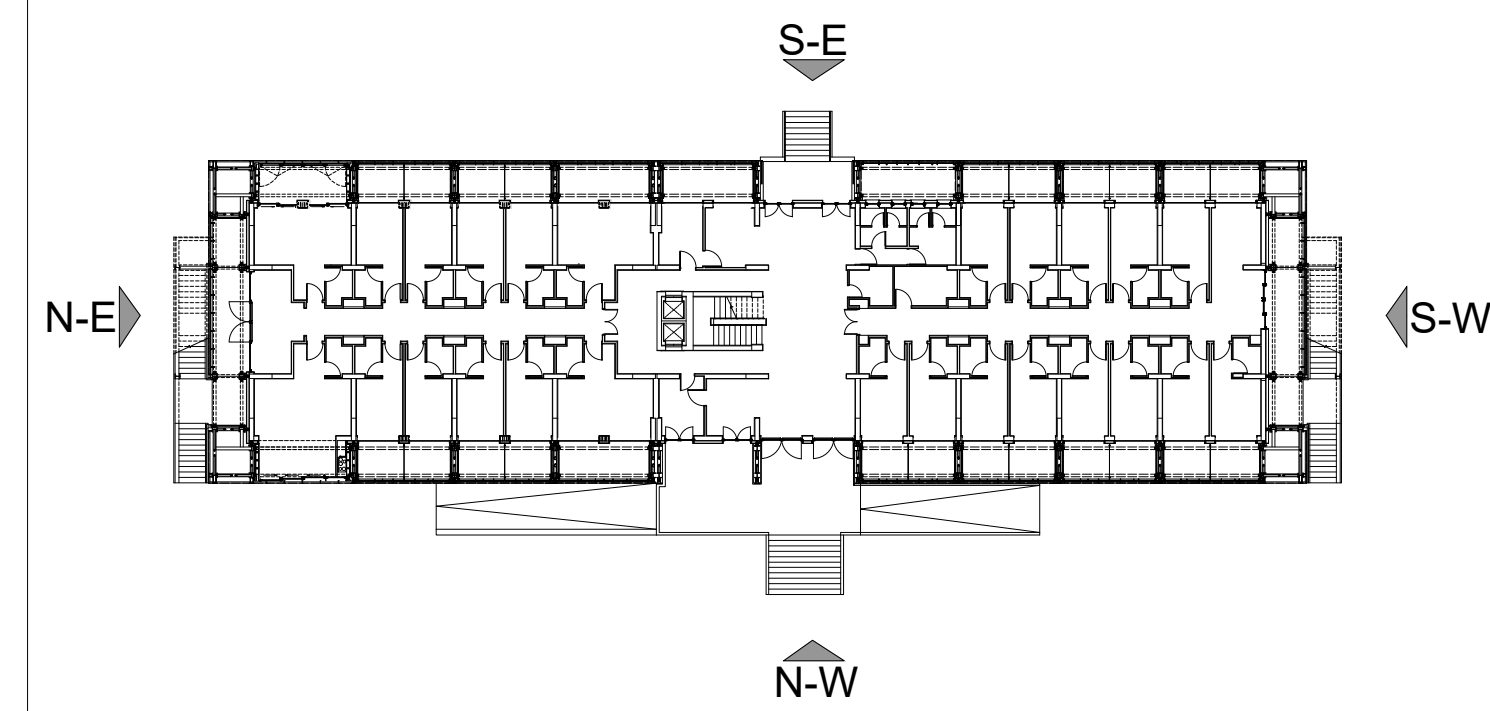

Acknowledgement

Proactive synergy of inteGrated Efficient Technologies on buildings Envelopes. The outputs of this research are part of the Pro-GET-one project, which has received funding from the European Union's Horizon 2020 Innovation action under grand agreement No 723747



Annexes to the doctoral thesis entitled

On the use of the exoskeleton for seismic improvement and integrated efficient technologies in existing buildings

of the candidate

Lorenzo Badini

Alma Mater Studiorum - University of Bologna
School of Engineering and Architecture
Department of Architecture

Technical University of Munich
Department of Civil, Geo and Environmental Engineering
Chair of Timber Structures and Building Construction

Case Study:

Building FEPA at University Campus of Zografou, Athens (Greece)

Contents

South-West Façade
North-East Façade
Scale 1:50

Board N°

9



Positioning on planimetric views

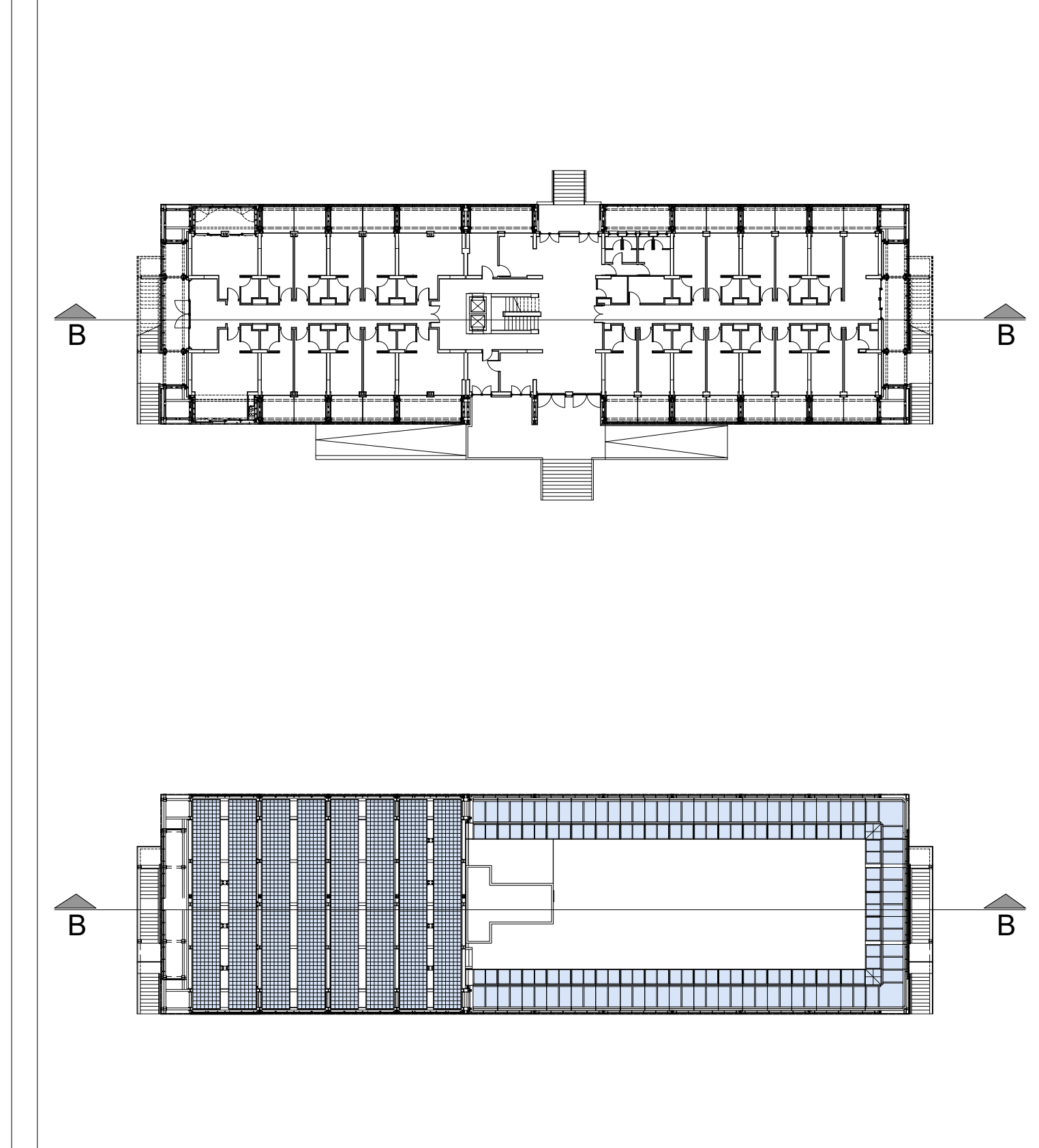

Acknowledgement
 Proactive synergy of integrated Efficient Technologies on buildings Envelopes. The outputs of this research are part of the Pro-GET-onE project, which has received funding from the European Union's Horizon 2020 Innovation action under grant agreement No 723747



Annexes to the doctoral thesis entitled
On the use of the exoskeleton for seismic improvement and integrated efficient technologies in existing buildings
 of the candidate
Lorenzo Badini

Alma Mater Studiorum - University of Bologna
 School of Engineering and Architecture
 Department of Architecture
 Technical University of Munich
 Department of Civil, Geo and Environmental Engineering
 Chair of Timber Structures and Building Construction

Case Study:
 Building FEPA at University Campus of Zografou, Athens (Greece)

Contents	Board N°
Section B-B Scale 1:50	10

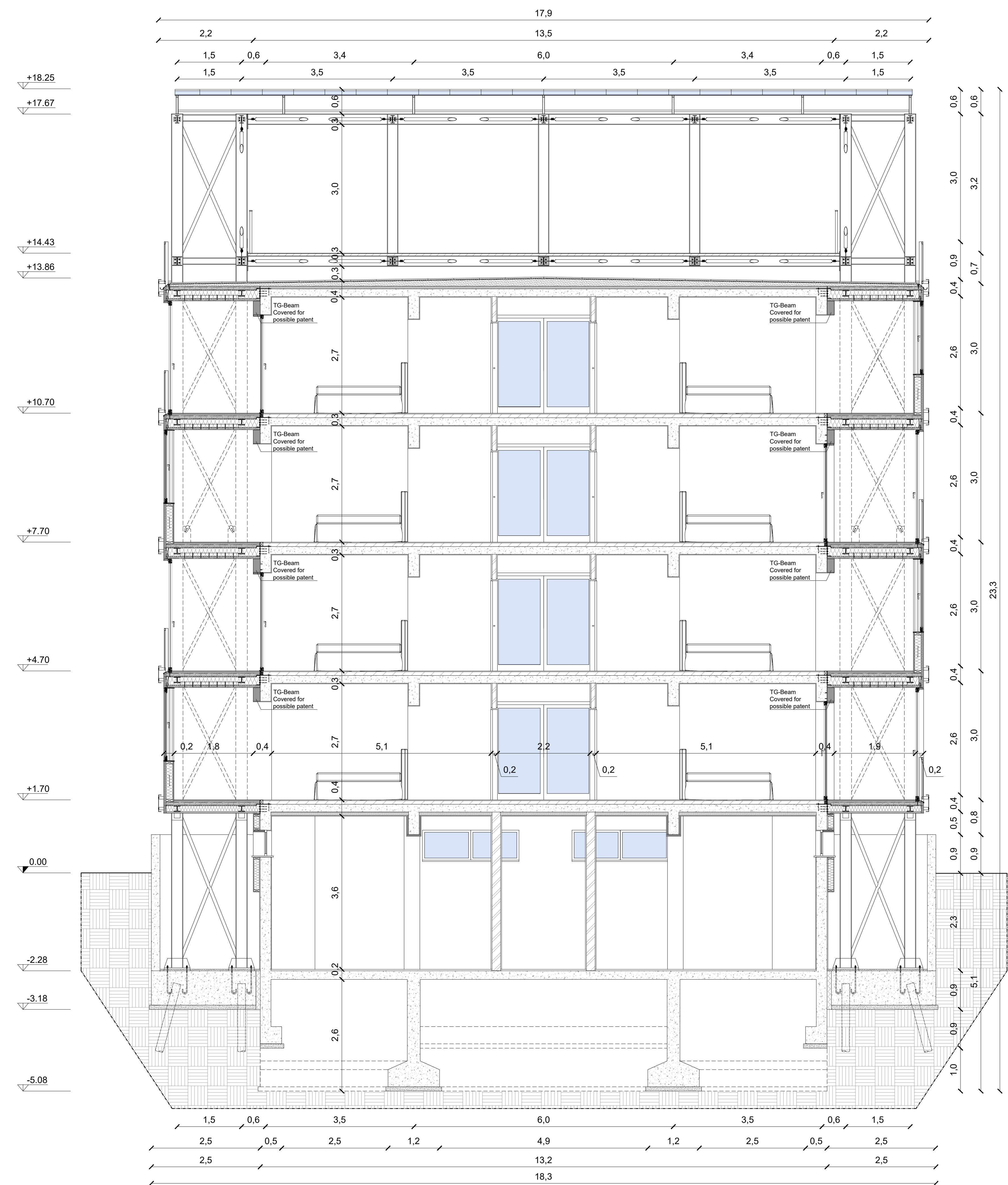

SECTION A-A

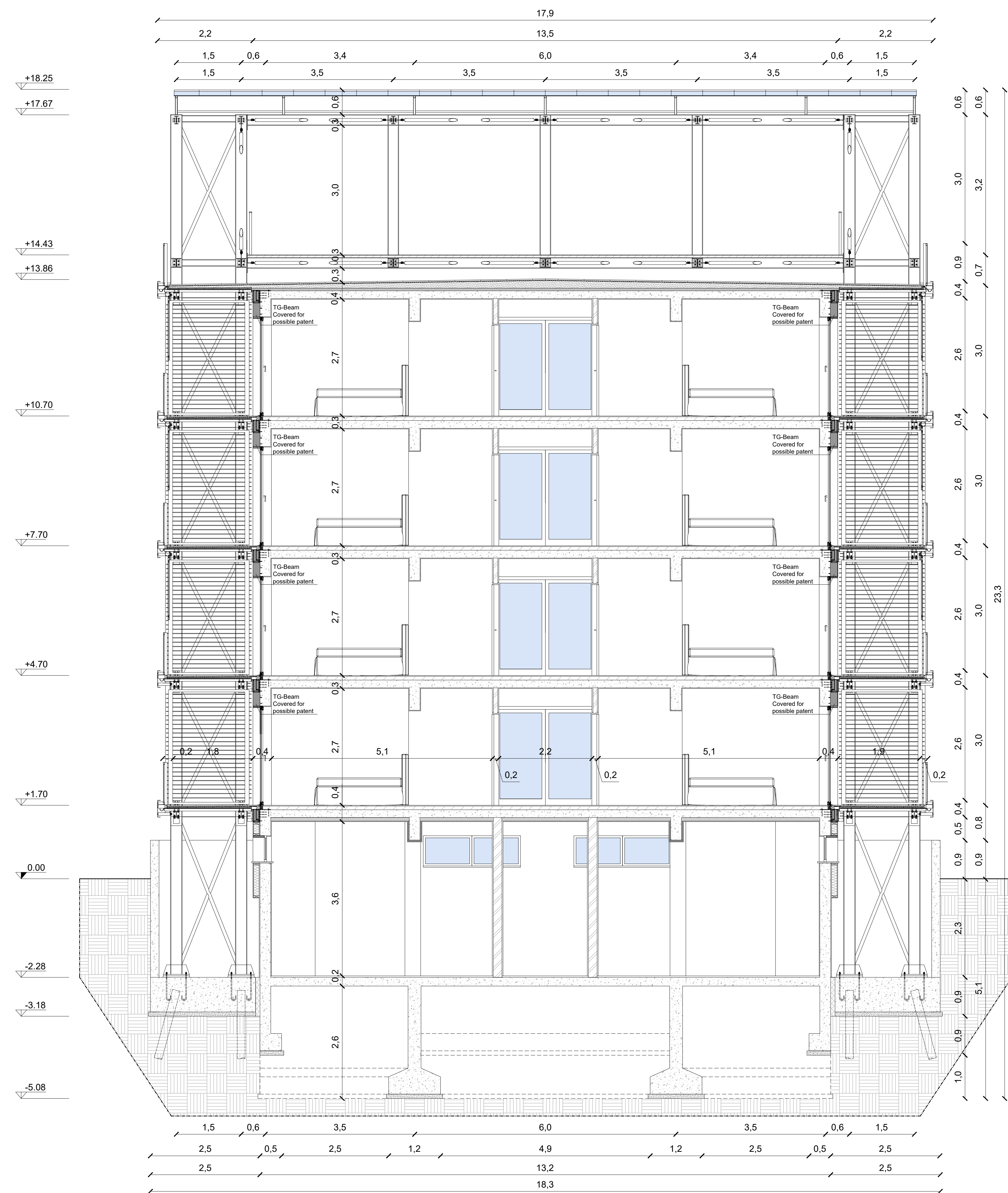

SECTION C-C

Positioning on planimetric views

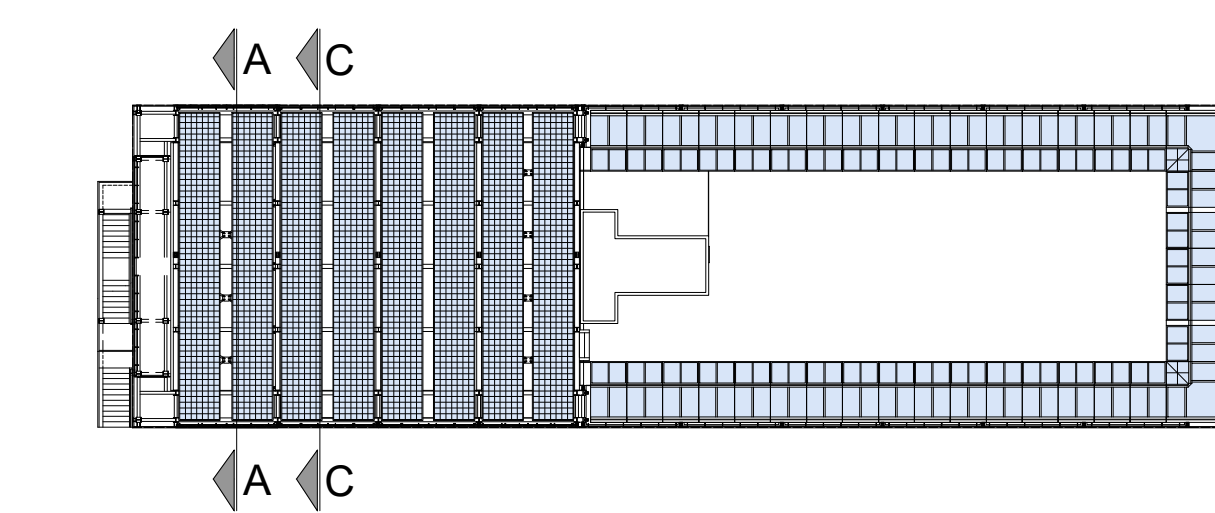
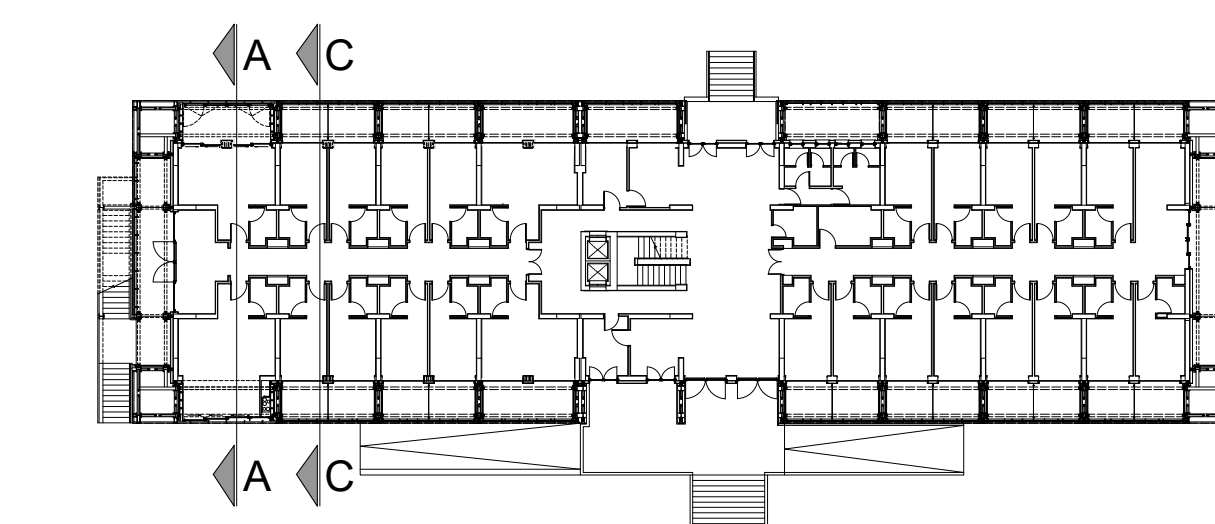

Acknowledgement

Proactive synergy of inteGrated Efficient Technologies on buildings Envelopes. The outputs of this research are part of the Pro-GET-one project, which has received funding from the European Union's Horizon 2020 Innovation action under grand agreement No 723747



Annexes to the doctoral thesis entitled

On the use of the exoskeleton for seismic improvement and integrated efficient technologies in existing buildings

of the candidate

Lorenzo Badini

Alma Mater Studiorum - University of Bologna
School of Engineering and Architecture
Department of Architecture

Technical University of Munich
Department of Civil, Geo and Environmental Engineering
Chair of Timber Structures and Building Construction

Case Study:

Building FEPA at University Campus of Zografou, Athens (Greece)

Contents

Section A-A
Section C-C
Scale 1:50

Board N°

11

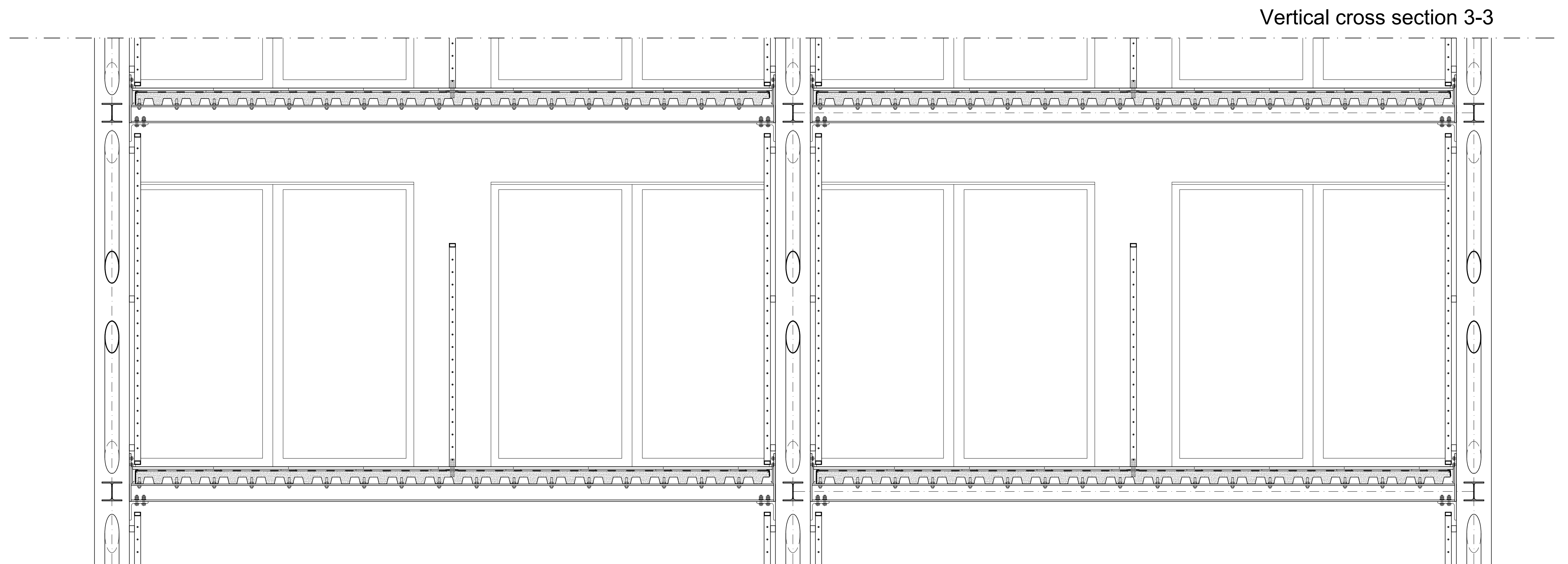
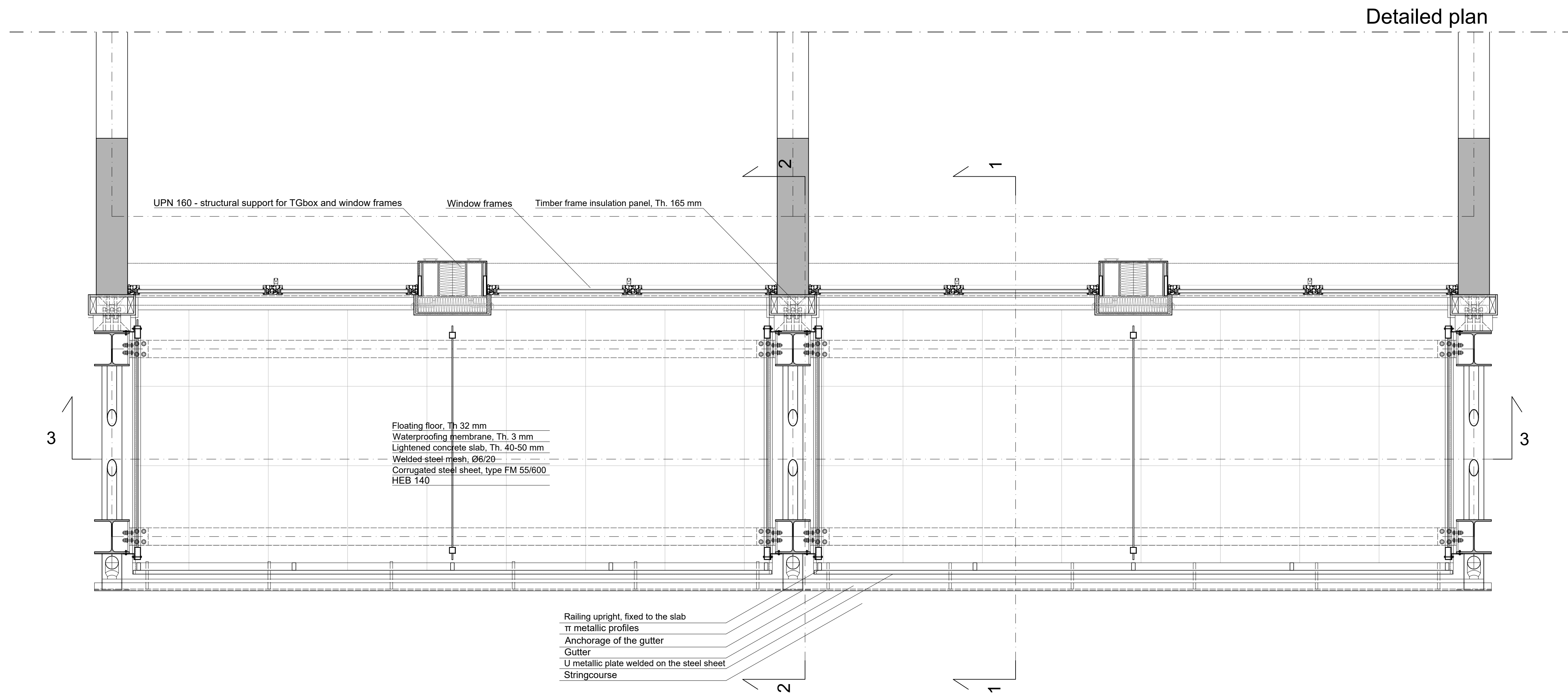

Positioning on ground floor horizontal cross section

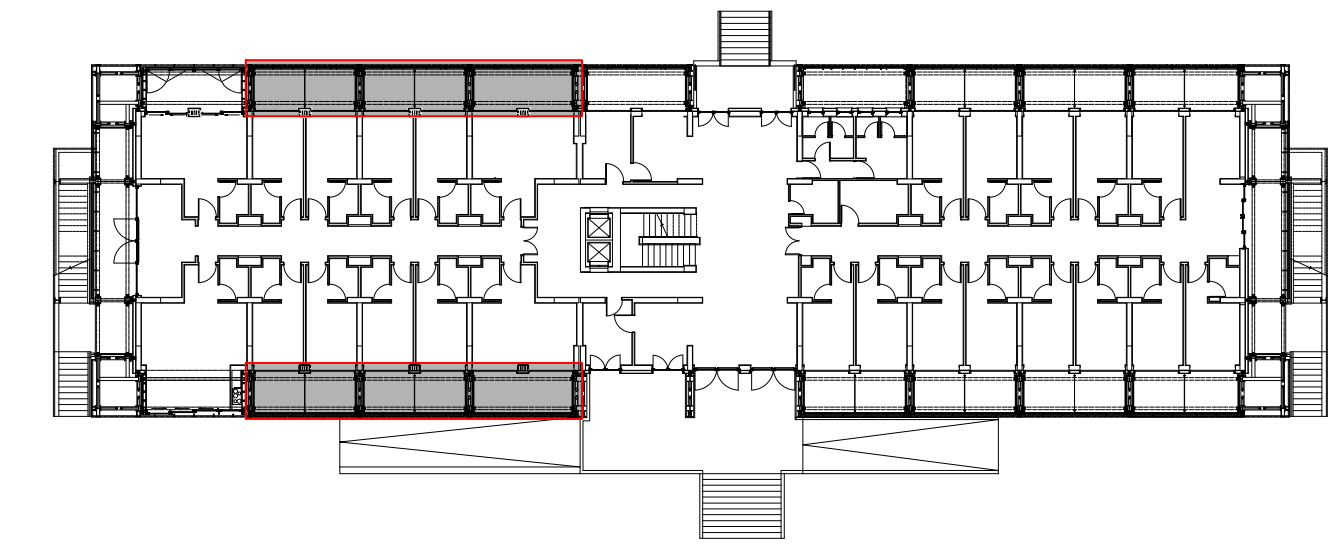

Acknowledgement

Proactive synergy of inteGrated Efficient Technologies on buildings Envelopes. The outputs of this research are part of the Pro-GET-onE project, which has received funding from the European Union's Horizon 2020 Innovation action under grand agreement No 723747



Annexes to the doctoral thesis entitled

On the use of the exoskeleton for seismic improvement and integrated efficient technologies in existing buildings

of the candidate

Lorenzo Badini

Alma Mater Studiorum - University of Bologna
School of Engineering and Architecture
Department of Architecture

Technical University of Munich
Department of Civil, Geo and Environmental Engineering
Chair of Timber Structures and Building Construction

Case Study:

Building FEPA at University Campus of Zografou, Athens (Greece)

Contents

Balcony unit - Composed steel & RC
Horizontal cross section
Vertical cross section 3-3
Scale 1:20

Board N°

12

Vertical cross section 1-1

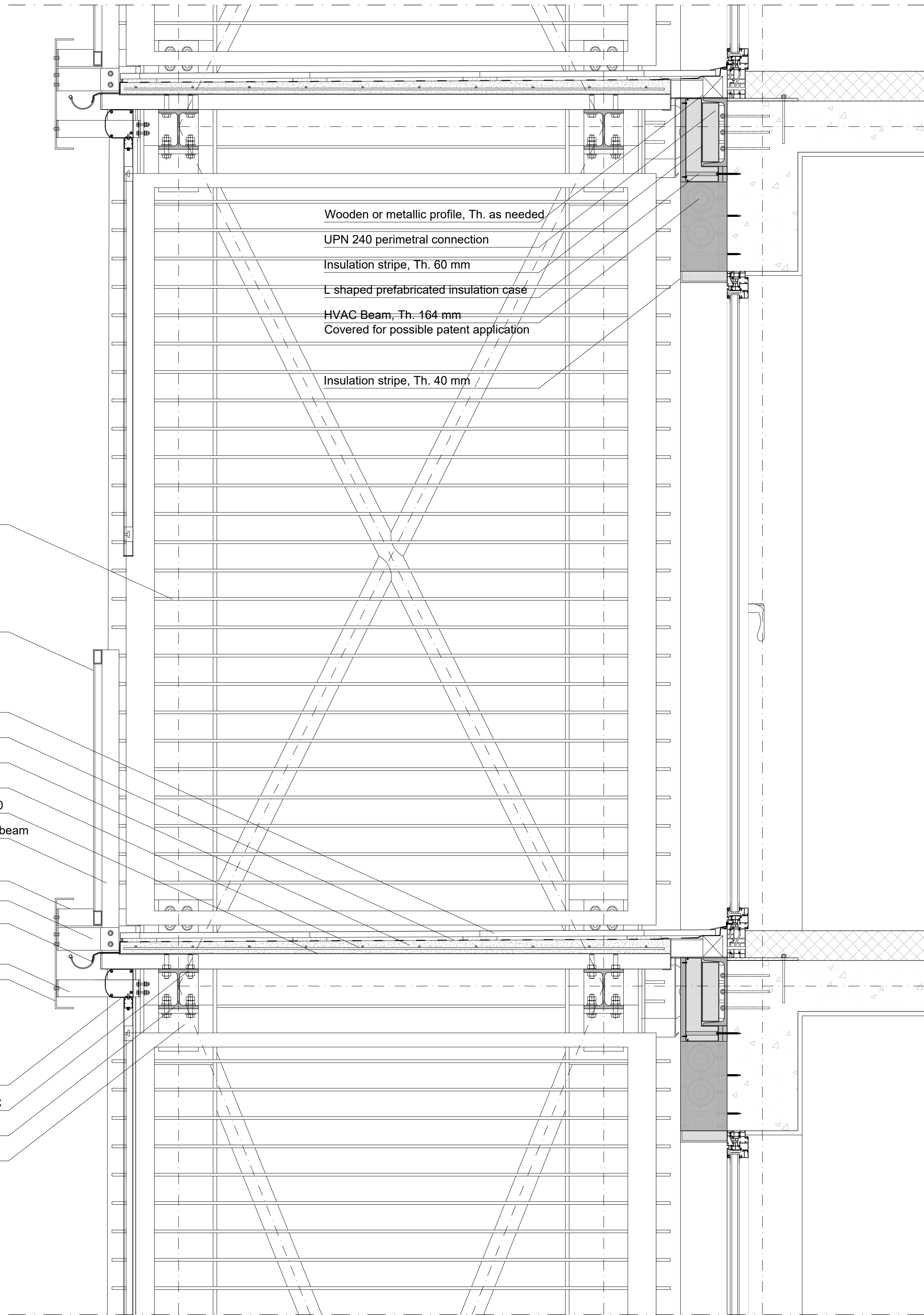

Metal grids to separate the units

Railing finishing: (alternatives)
 -expanded metal
 -perforated metal sheet
 -vertical rods

Floating floor, Th 32 mm

Waterproofing membrane, Th. 3 mm

Lightened concrete slab, Th. 40-50 mm

Welded steel mesh, Ø6/20

Corrugated steel sheet, type FM 55/600

Railing upright 30x60 fixed to the long. beam

π metallic profiles, anchorage for the stringcourse to the columns

Metallic plate fixed on the upright

Gutter

H metallic profiles, anchorage for the stringcourse to the floor

Stringcourse

Shading device

Bolt thread with nuts, fixed in the RC

HEB 140

Angle bar 150

Vertical cross section 2-2

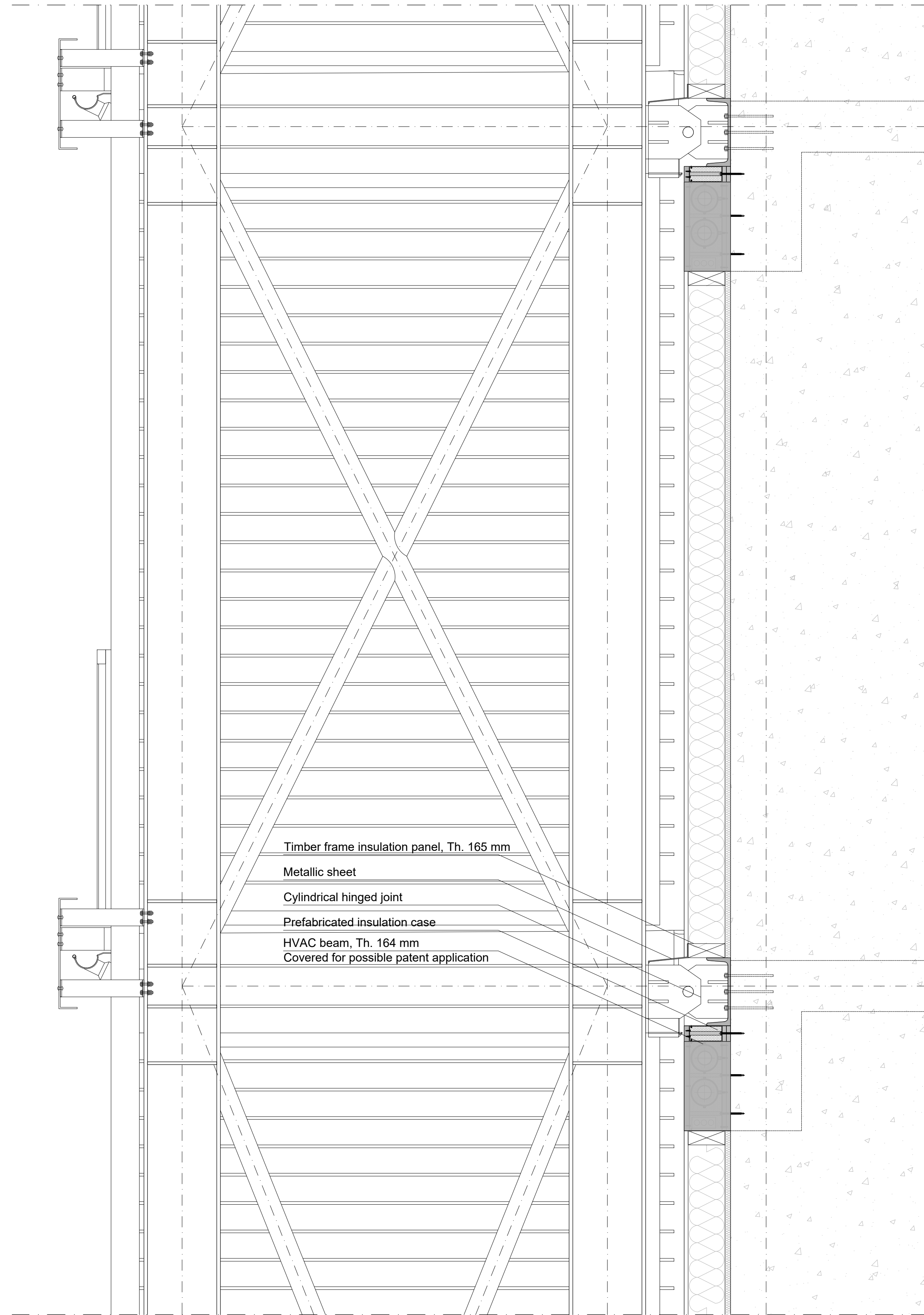

Positioning on vertical cross section

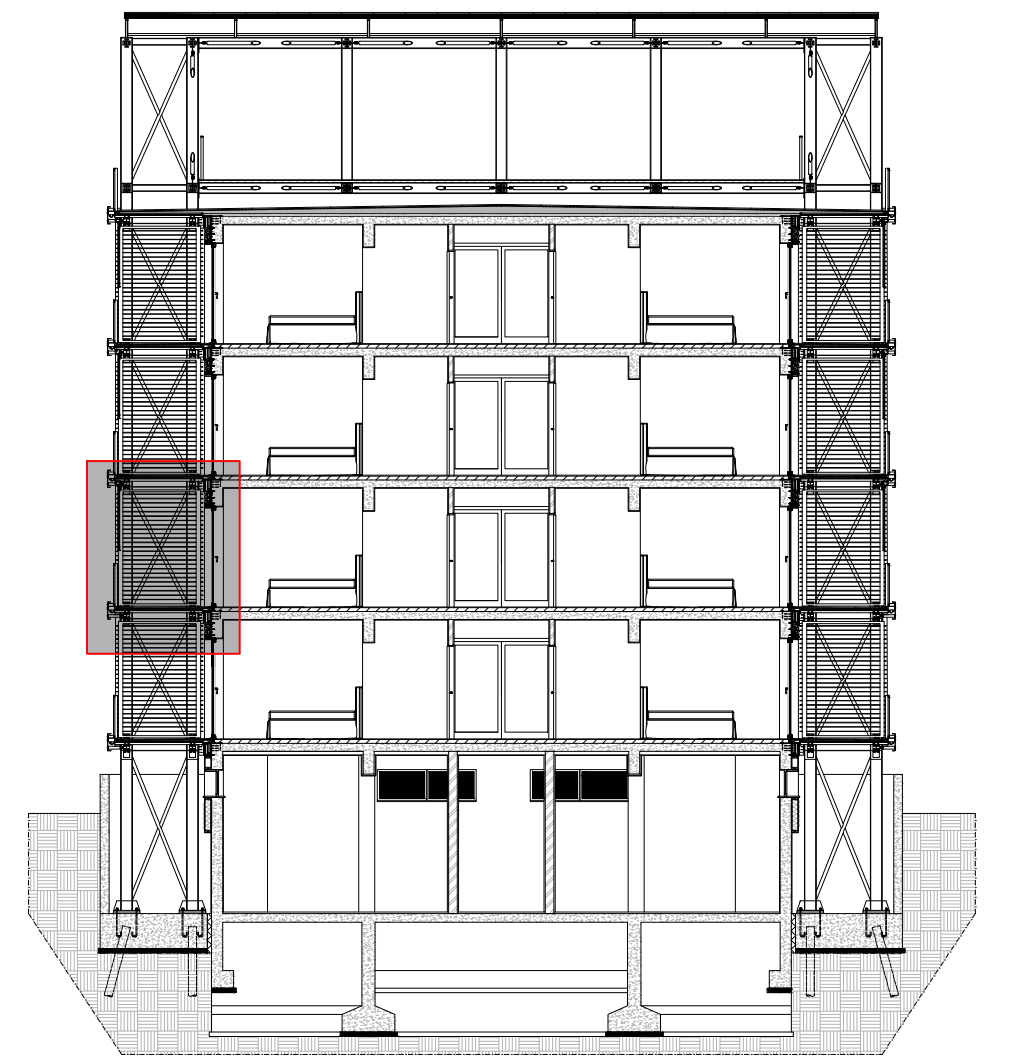

Acknowledgement

Proactive synergy of inteGrated Efficient Technologies on buildings Envelopes. The outputs of this research are part of the Pro-GET-onE project, which has received funding from the European Union's Horizon 2020 Innovation action under grand agreement No 723747



Annexes to the doctoral thesis entitled

On the use of the exoskeleton for seismic improvement and integrated efficient technologies in existing buildings

of the candidate

Lorenzo Badini

Alma Mater Studiorum - University of Bologna
 School of Engineering and Architecture
 Department of Architecture

Technical University of Munich
 Department of Civil, Geo and Environmental Engineering
 Chair of Timber Structures and Building Construction

Case Study:

Building FEPA at University Campus of Zografou, Athens (Greece)

Contents

Balcony unit - Composed steel & RC
 Vertical cross section 1-1
 Vertical cross section 2-2
 Scale 1:10

Board N°

13

Vertical cross section 1-1

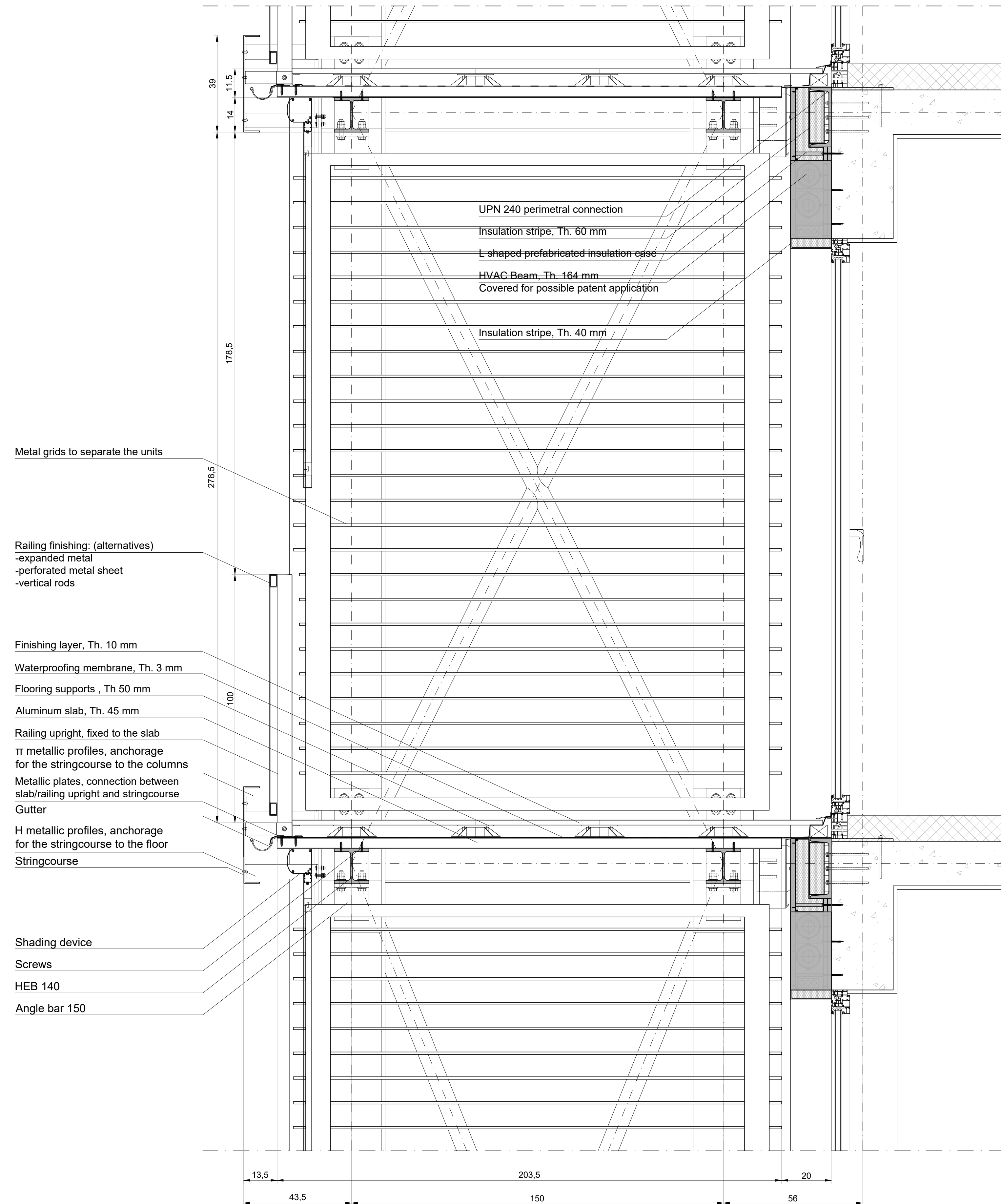

Detailed plan - Single unit

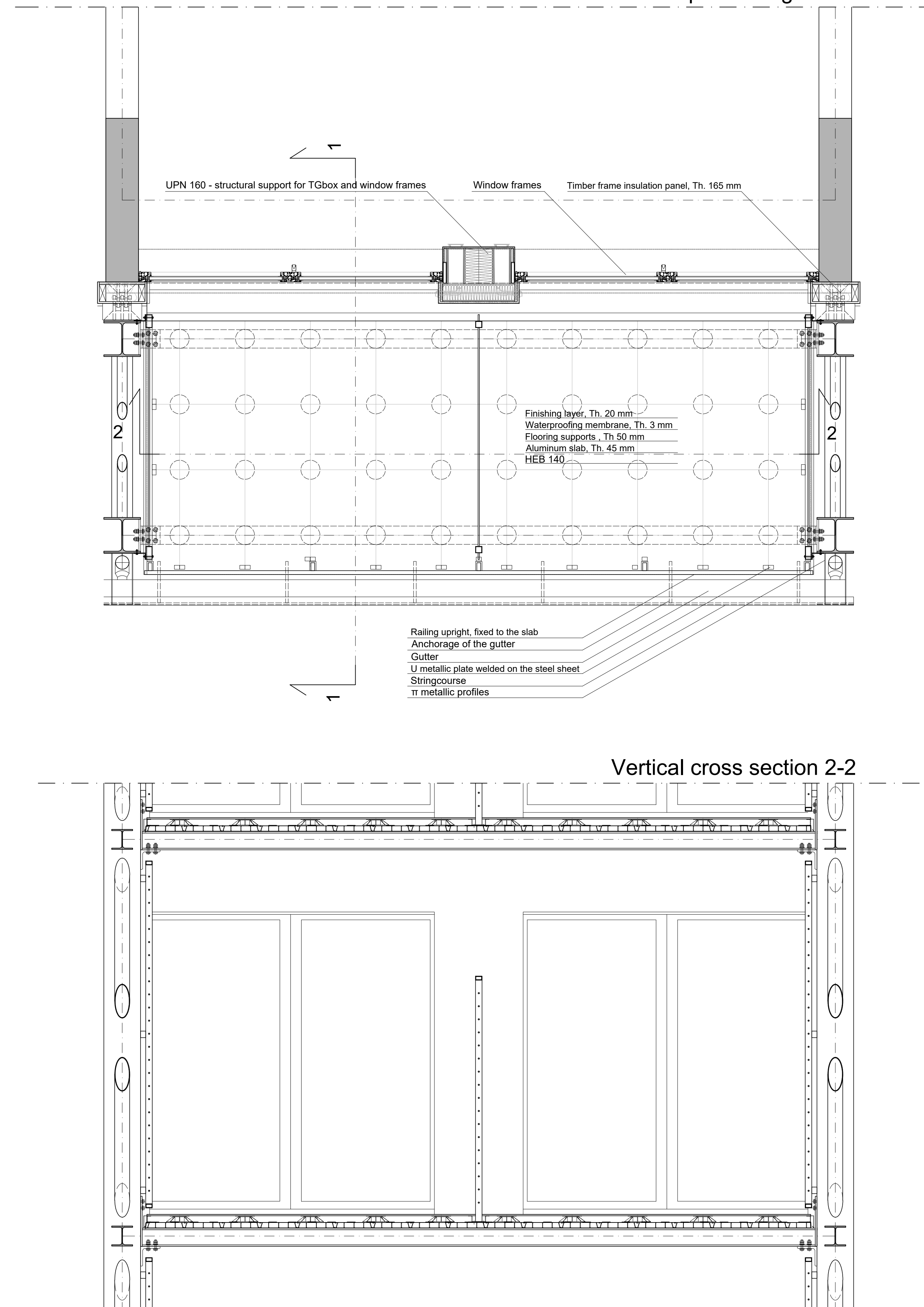

Vertical cross section 2-2

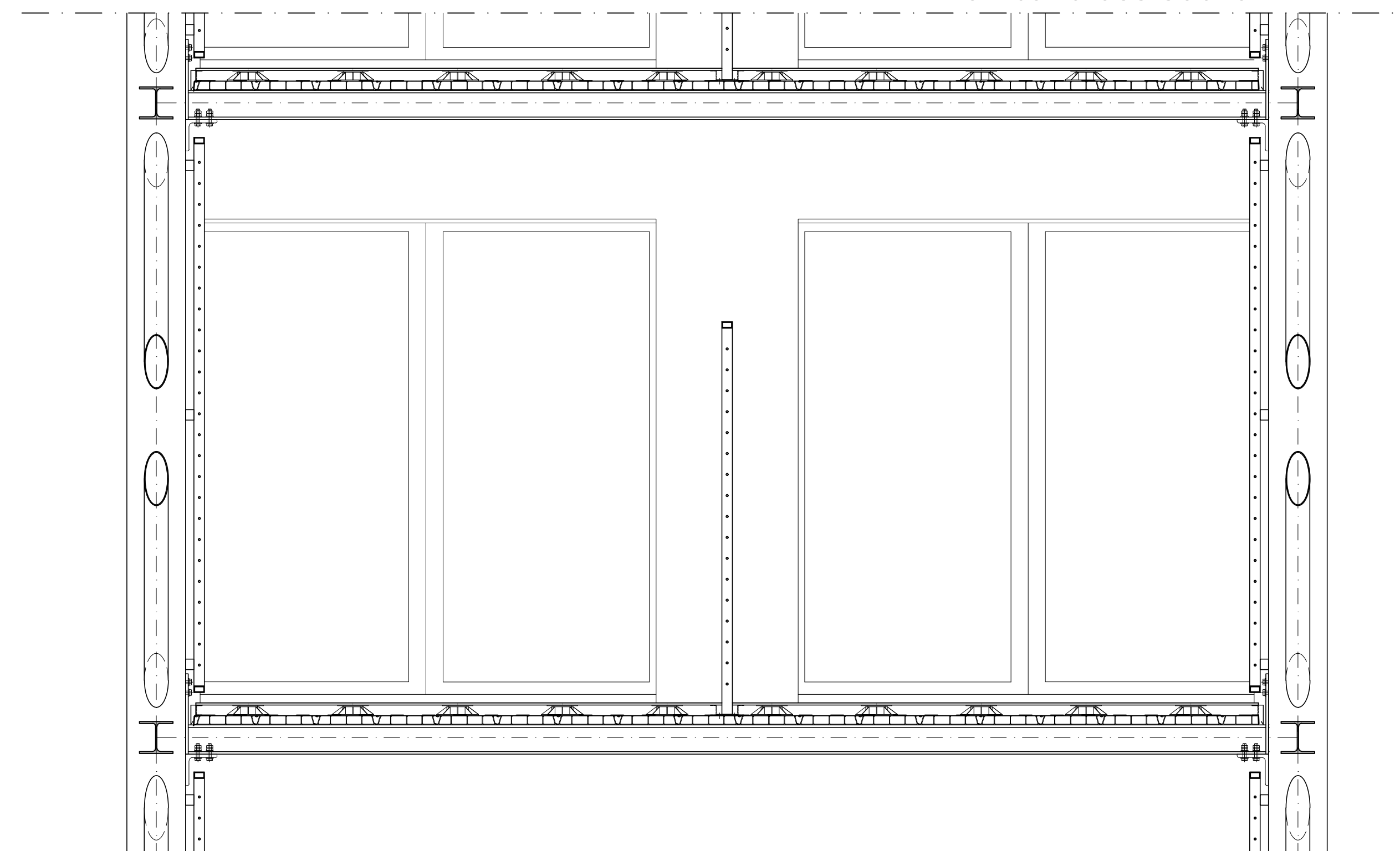

Positioning on ground floor horizontal cross section

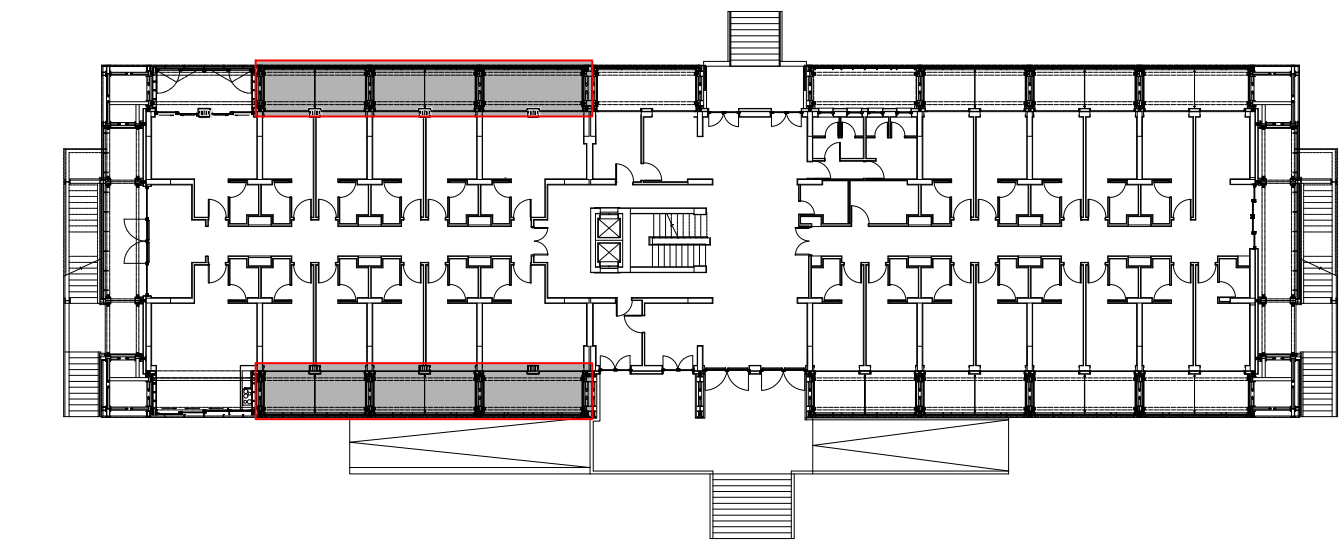

Acknowledgement

Proactive synergy of inteGrated Efficient Technologies on buildings Envelopes. The outputs of this research are part of the Pro-GET-onE project, which has received funding from the European Union's Horizon 2020 Innovation action under grand agreement No 723747



Annexes to the doctoral thesis entitled

On the use of the exoskeleton for seismic improvement and integrated efficient technologies in existing buildings

of the candidate

Lorenzo Badini

Alma Mater Studiorum - University of Bologna
 School of Engineering and Architecture
 Department of Architecture

Technical University of Munich
 Department of Civil, Geo and Environmental Engineering
 Chair of Timber Structures and Building Construction

Case Study:

Building FEPA at University Campus of Zografou, Athens (Greece)

Contents

- Balcony unit - Aluminium solution
- Vertical cross section 1-1
- Scale 1:10
- Horizontal cross section
- Vertical cross section 3-3
- Scale 1:20

Board N°

14

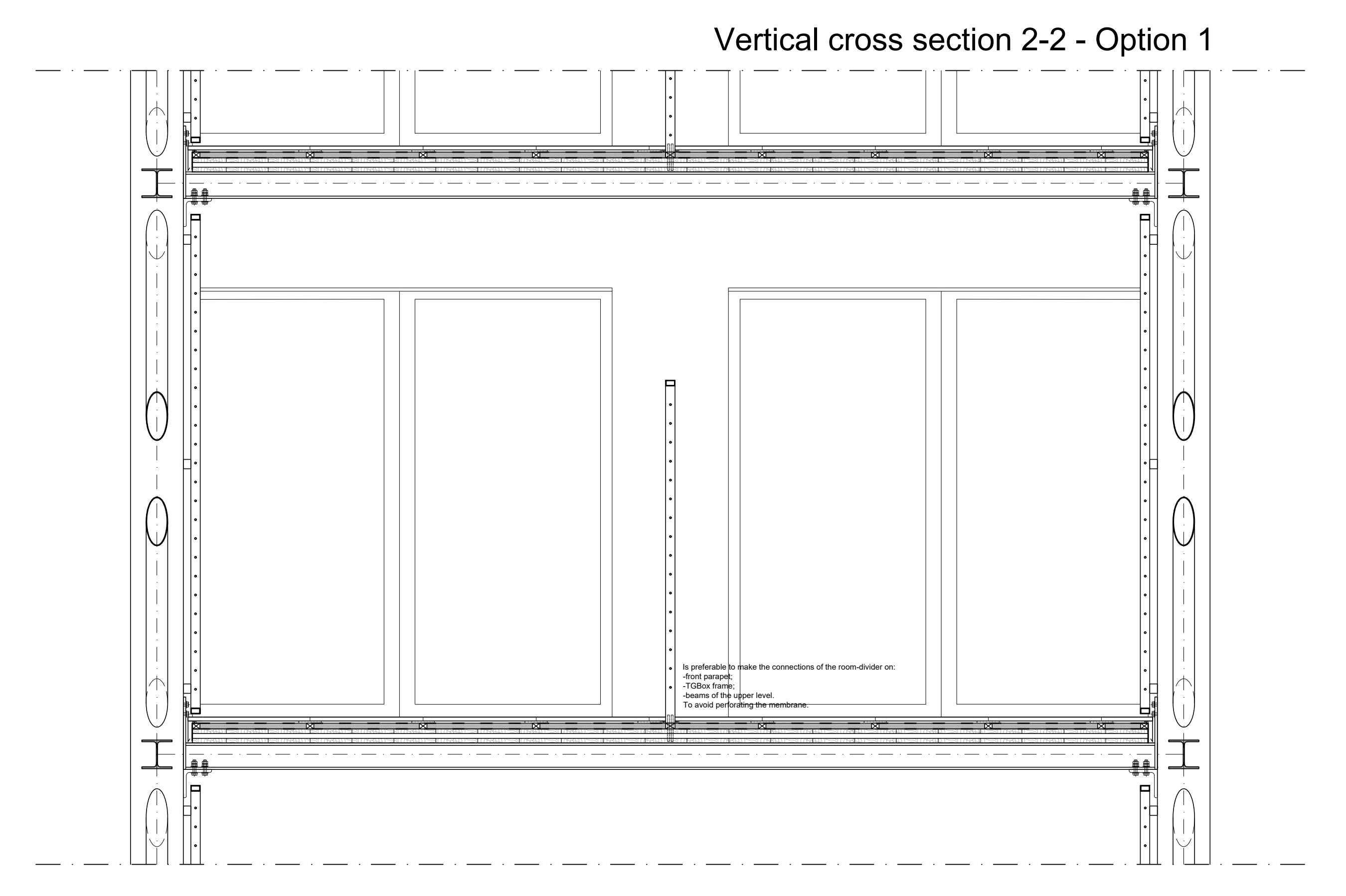
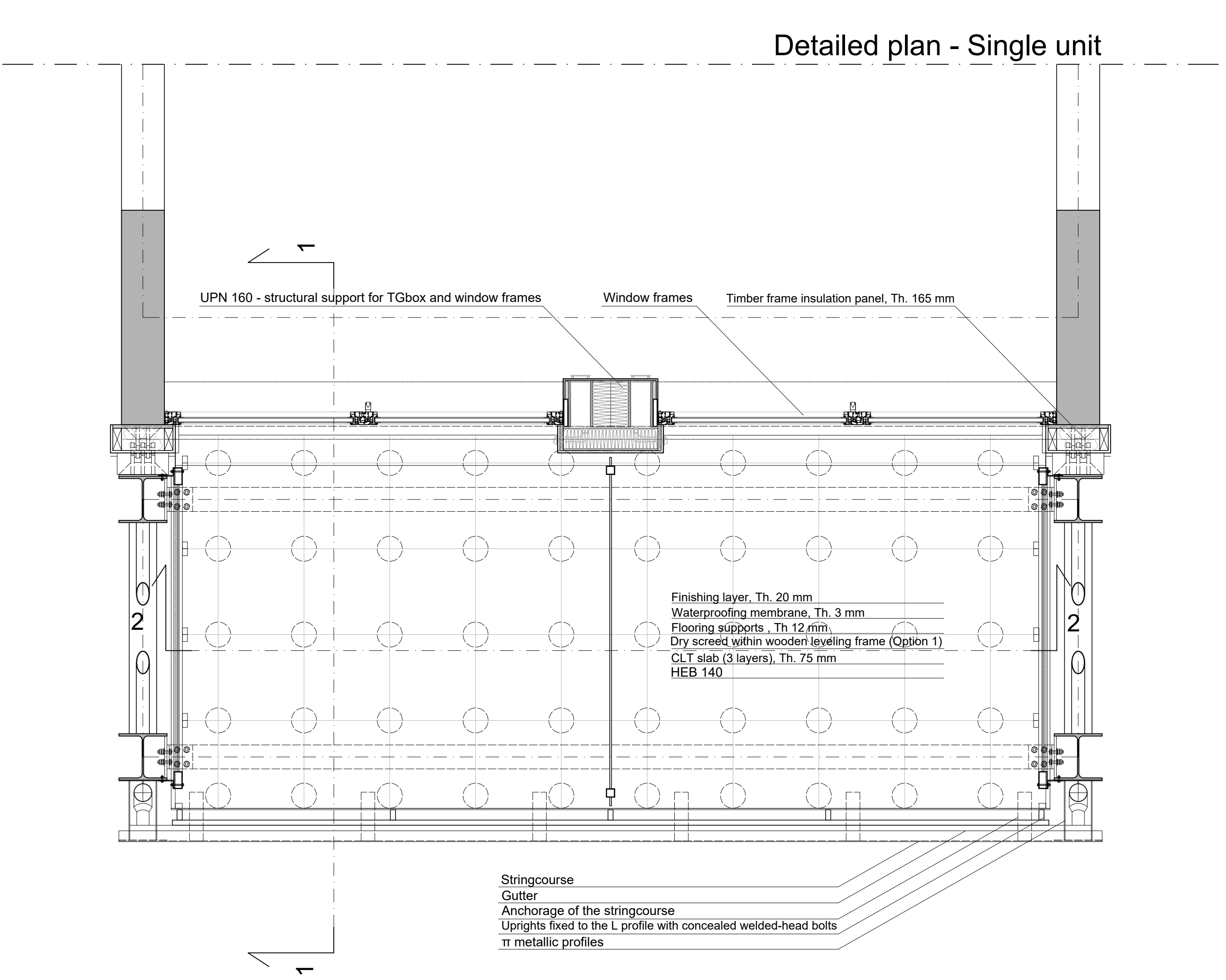
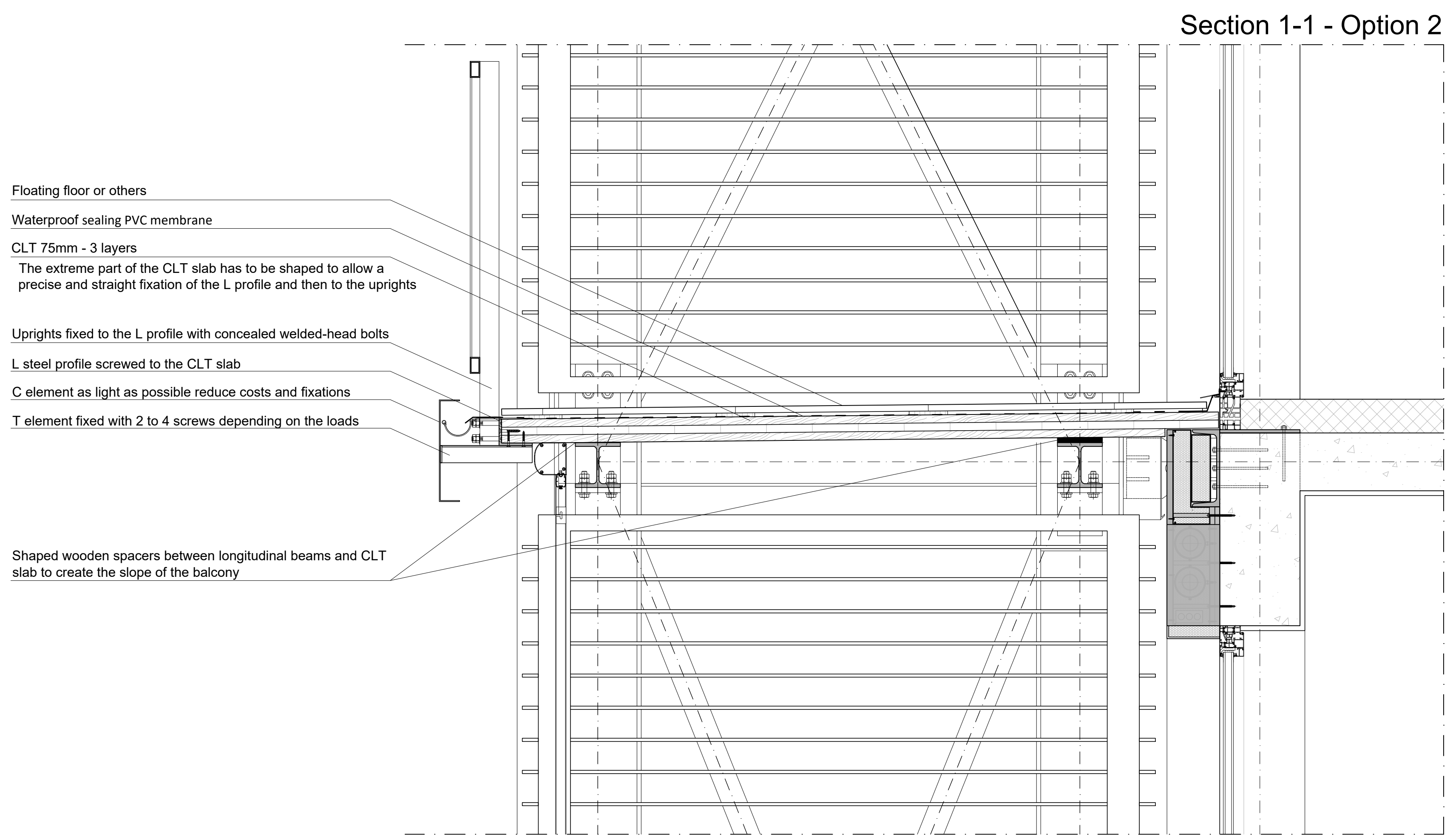
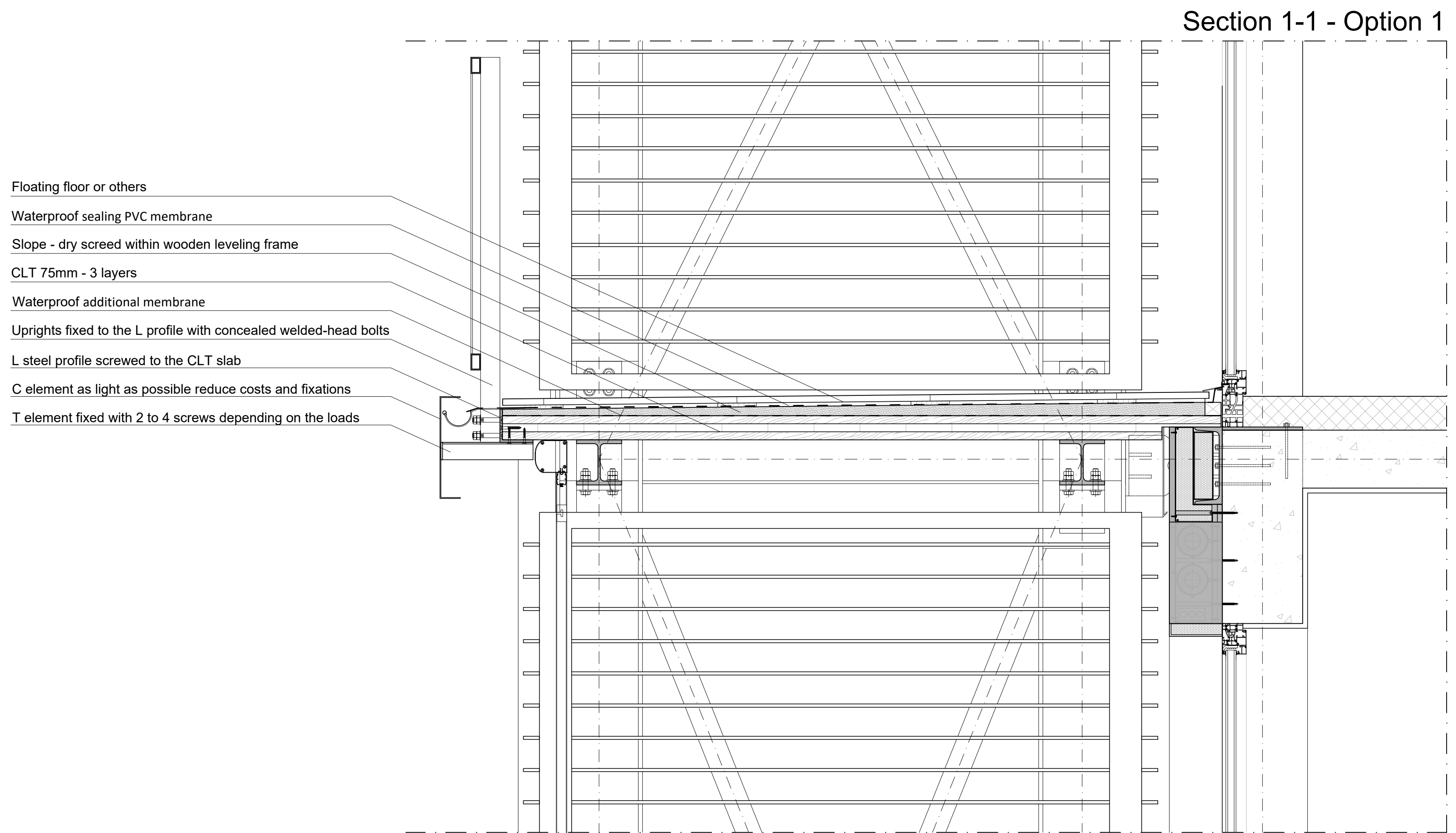

Positioning on ground floor horizontal cross section

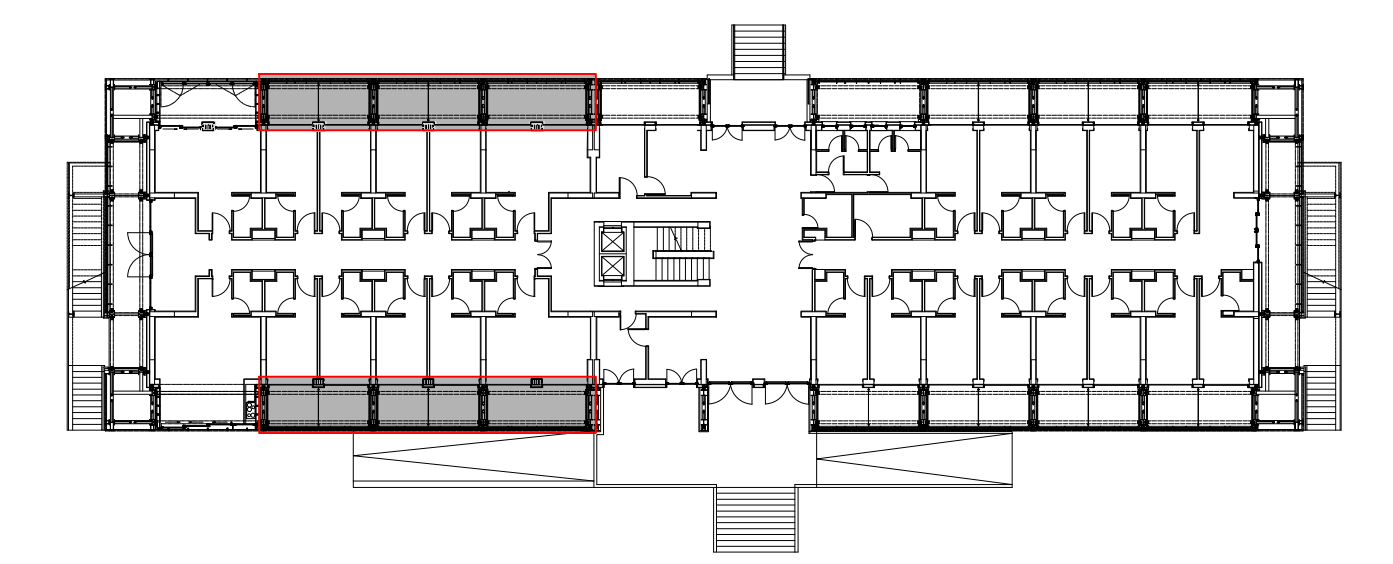

Acknowledgement

Proactive synergy of inteGrated Efficient Technologies on buildings Envelopes. The outputs of this research are part of the Pro-GET-onE project, which has received funding from the European Union's Horizon 2020 Innovation action under grand agreement No 723747



Annexes to the doctoral thesis entitled

On the use of the exoskeleton for seismic improvement and integrated efficient technologies in existing buildings

of the candidate

Lorenzo Badini

Alma Mater Studiorum - University of Bologna
School of Engineering and Architecture
Department of Architecture

Technical University of Munich
Department of Civil, Geo and Environmental Engineering
Chair of Timber Structures and Building Construction

Case Study:

Building FEPA at University Campus of Zografou, Athens (Greece)

Contents

- Balcony unit - CLT solutions
- Horizontal cross section
- Vertical cross section 2-2
- Scale 1:20
- Vertical cross section 1-1 (option 1, 2)
- Scale 1:10

Board N°

15

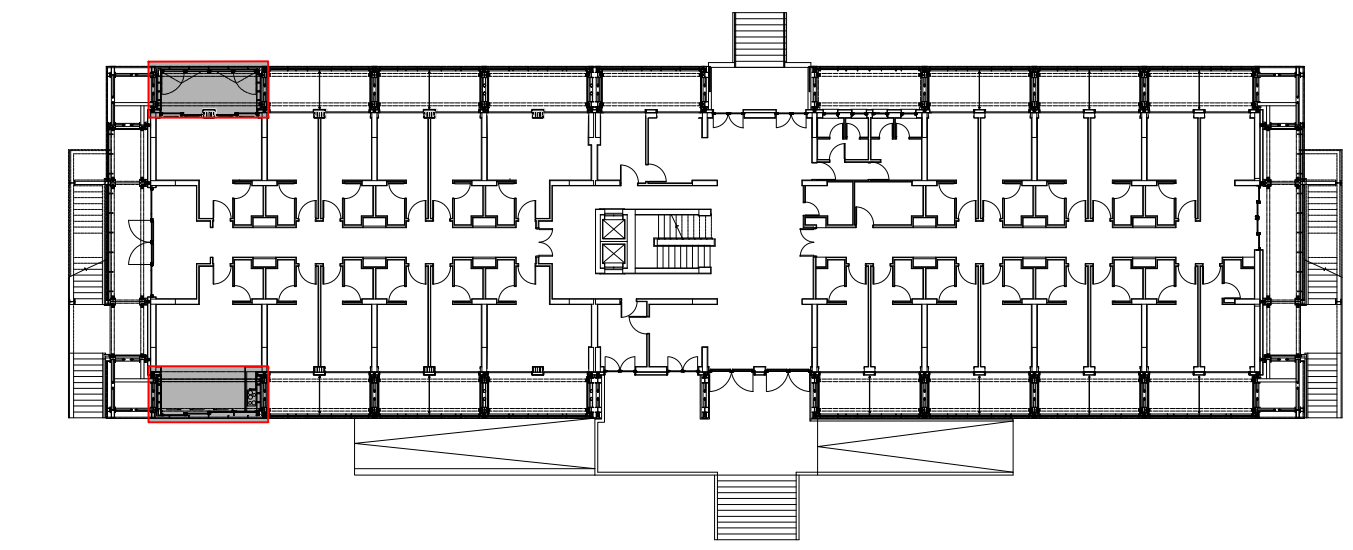

Horizontal cross section 1-1

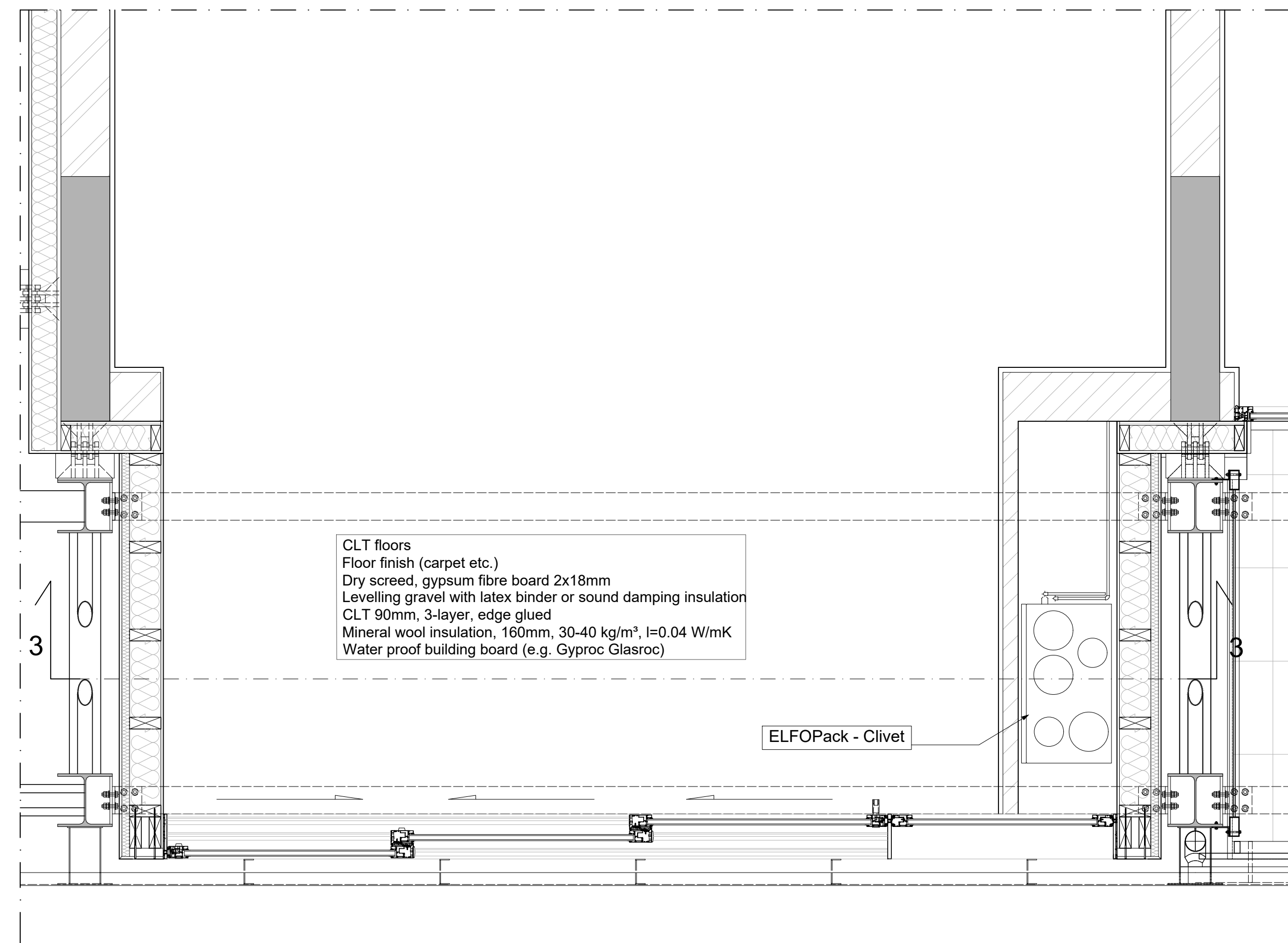

Horizontal cross section 2-2

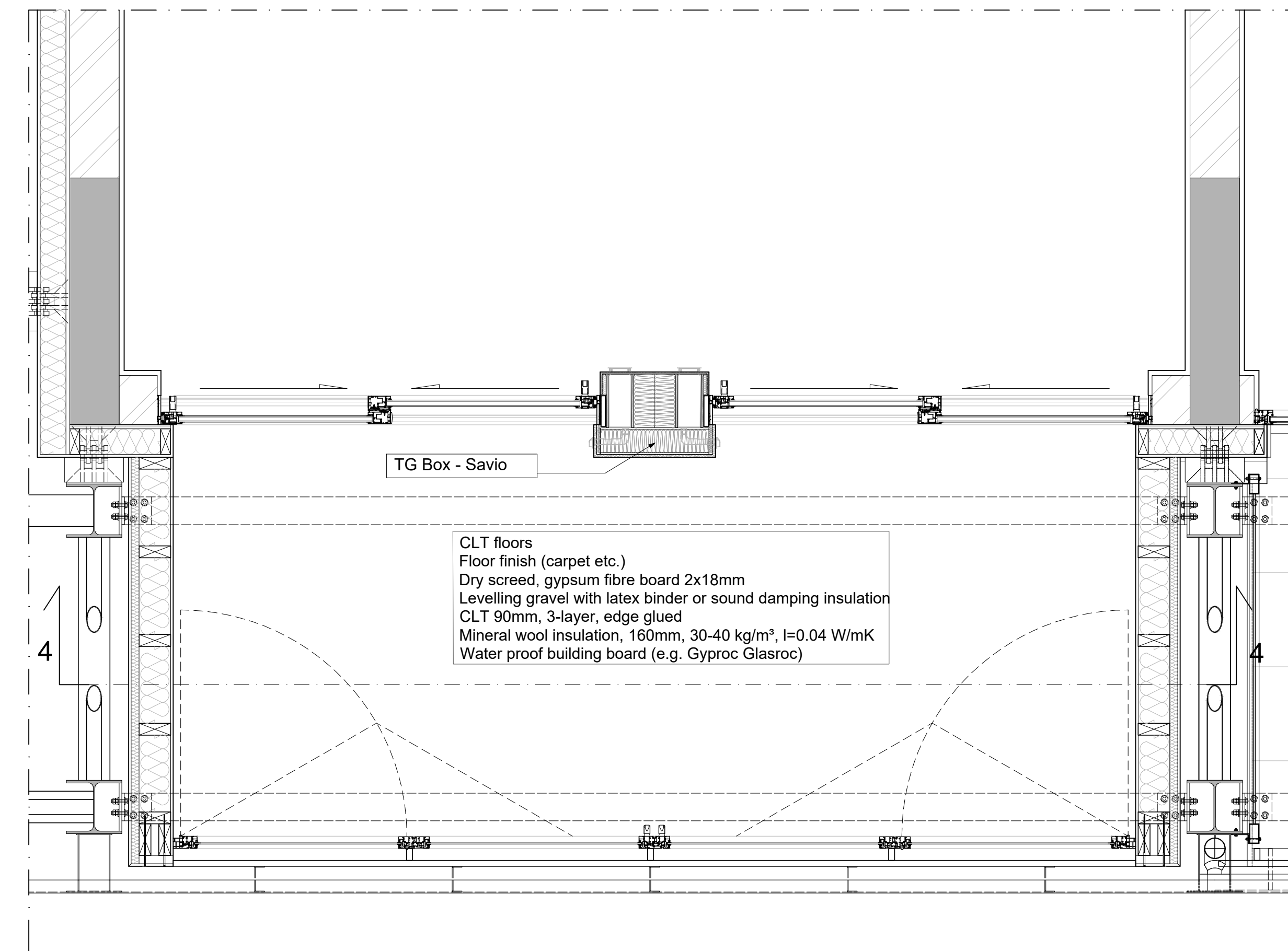

Vertical cross section 3-3

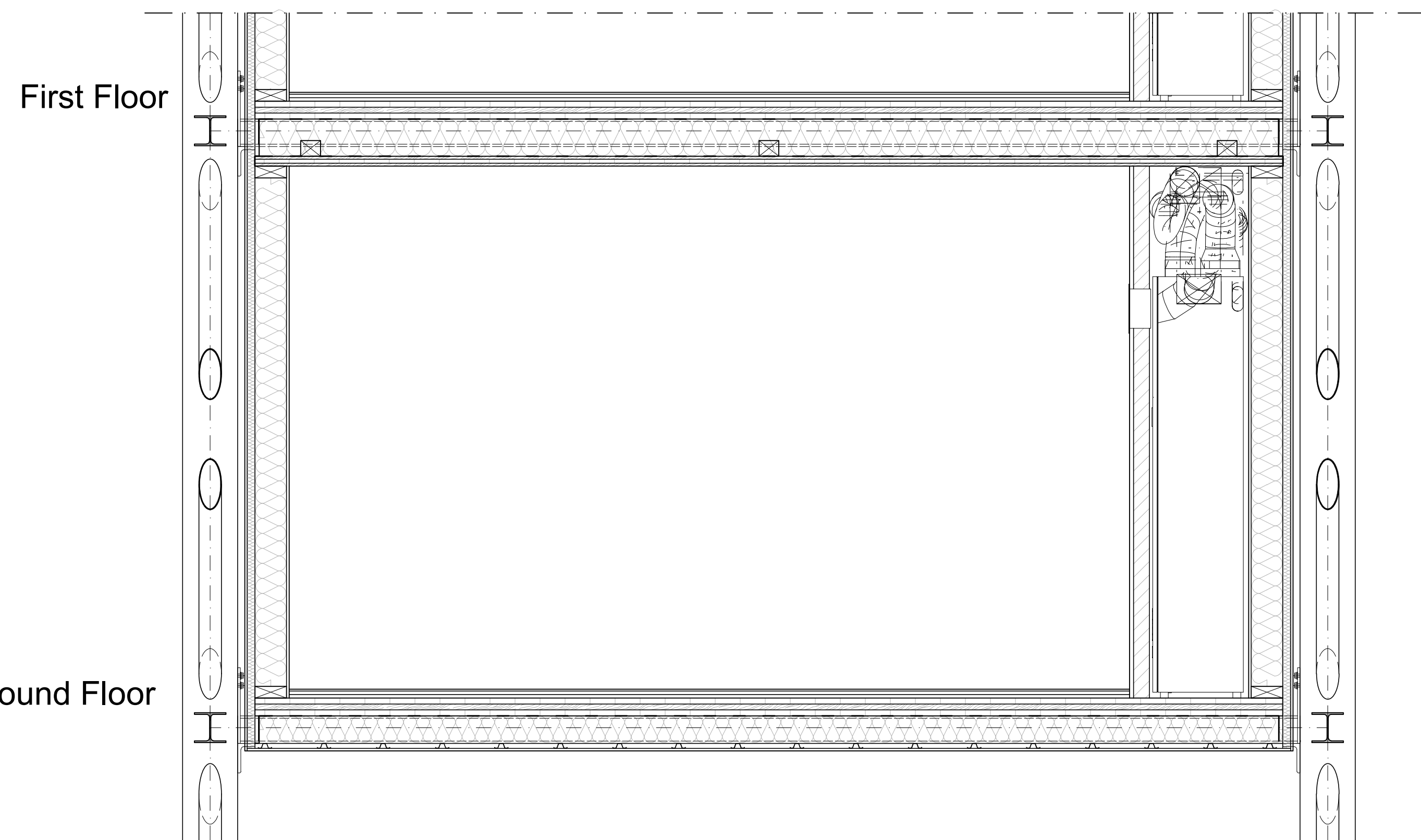

Vertical cross section 4-4

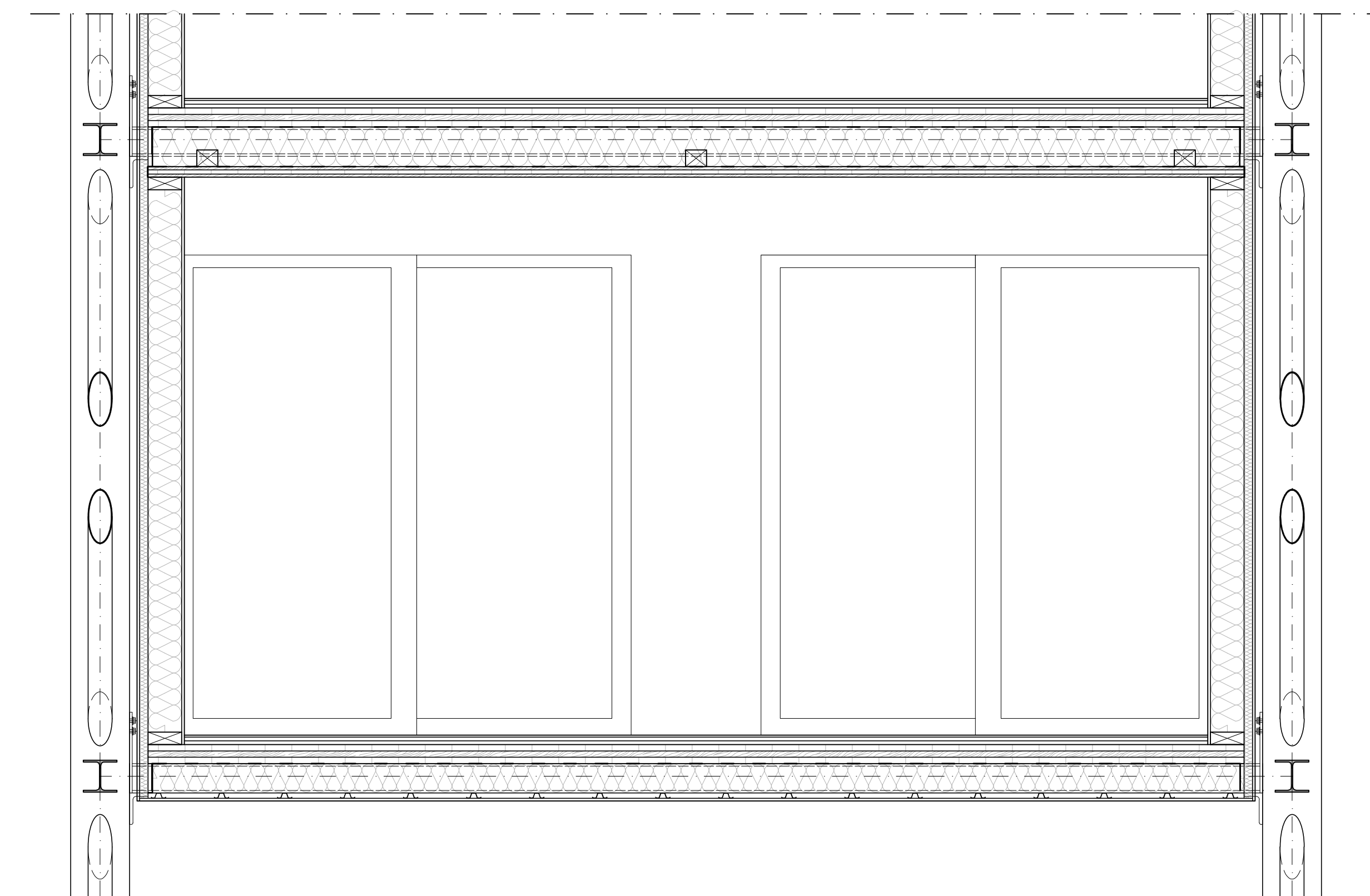

Acknowledgement

Proactive synergy of inteGrated Efficient Technologies on buildings Envelopes. The outputs of this research are part of the Pro-GET-onE project, which has received funding from the European Union's Horizon 2020 Innovation action under grand agreement No 723747



Annexes to the doctoral thesis entitled

On the use of the exoskeleton for seismic improvement and integrated efficient technologies in existing buildings

of the candidate

Lorenzo Badini

Alma Mater Studiorum - University of Bologna
School of Engineering and Architecture
Department of Architecture

Technical University of Munich
Department of Civil, Geo and Environmental Engineering
Chair of Timber Structures and Building Construction

Case Study:

Building FEPA at University Campus of Zografou, Athens (Greece)

Contents

Extra-room/sun-space
Horizontal cross section 1-1 / 2-2
Vertical cross section 3-3 / 4-4
Scale 1:20

Board N°

16

Exterior timber-frame walls (U=0.31-0.33 W/m²K)
 Plastered ETIC-system a=50 mm, mineral wool based (class A1, non-combustible)
 Facade membrane, water tight, diffusion open (sd<0,1m)
 Exterior panelling, 15 mm water proof building board (e.g. Gyproc Glasroc)
 Mineral wool insulation 140 mm, 30-80 kg/m³, l=0.035 W/mK
 Timber framework 140x60 mm, softwood, C24
 Interior panelling, 12 mm OSB board, taped seams
 Interior plaster board 12.5mm

3x wooden beam 80x60 for fixation of the box
 (assembled after box is put in final position and
 fit inbetween longitudinal steel beams)

Box ceiling
 Roof membrane sd < 0,2m
 Insulation mineral wool 180 mm, 30-80 kg/m³, l=0.035 W/mK
 Vapour retardent membrane sd > 2m
 Solid wood panel 50 mm (e.g. 3S Rubner Nordpan)

3x wooden beam 80x60 for fixation of the box
 (assembled after box is put in final position and
 fit inbetween longitudinal steel beams)

Box ceiling
 Roof membrane sd < 0,2m
 Insulation mineral wool 180 mm, 30-80 kg/m³, l=0.035 W/mK
 Vapour retardent membrane sd > 2m
 Solid wood panel 50 mm (e.g. 3S Rubner Nordpan)

CLT floors
 Floor finish (carpet etc.)
 Dry screed, gypsum fibre board 2x18mm
 Levelling gravel with latex binder or sound damping insulation
 CLT 90mm, 3-layer, edge glued
 Mineral wool insulation, 160mm, 30-40 kg/m³, l=0.04 W/mK
 Water proof building board (e.g. Gyproc Glasroc)

Positioning on vertical cross section

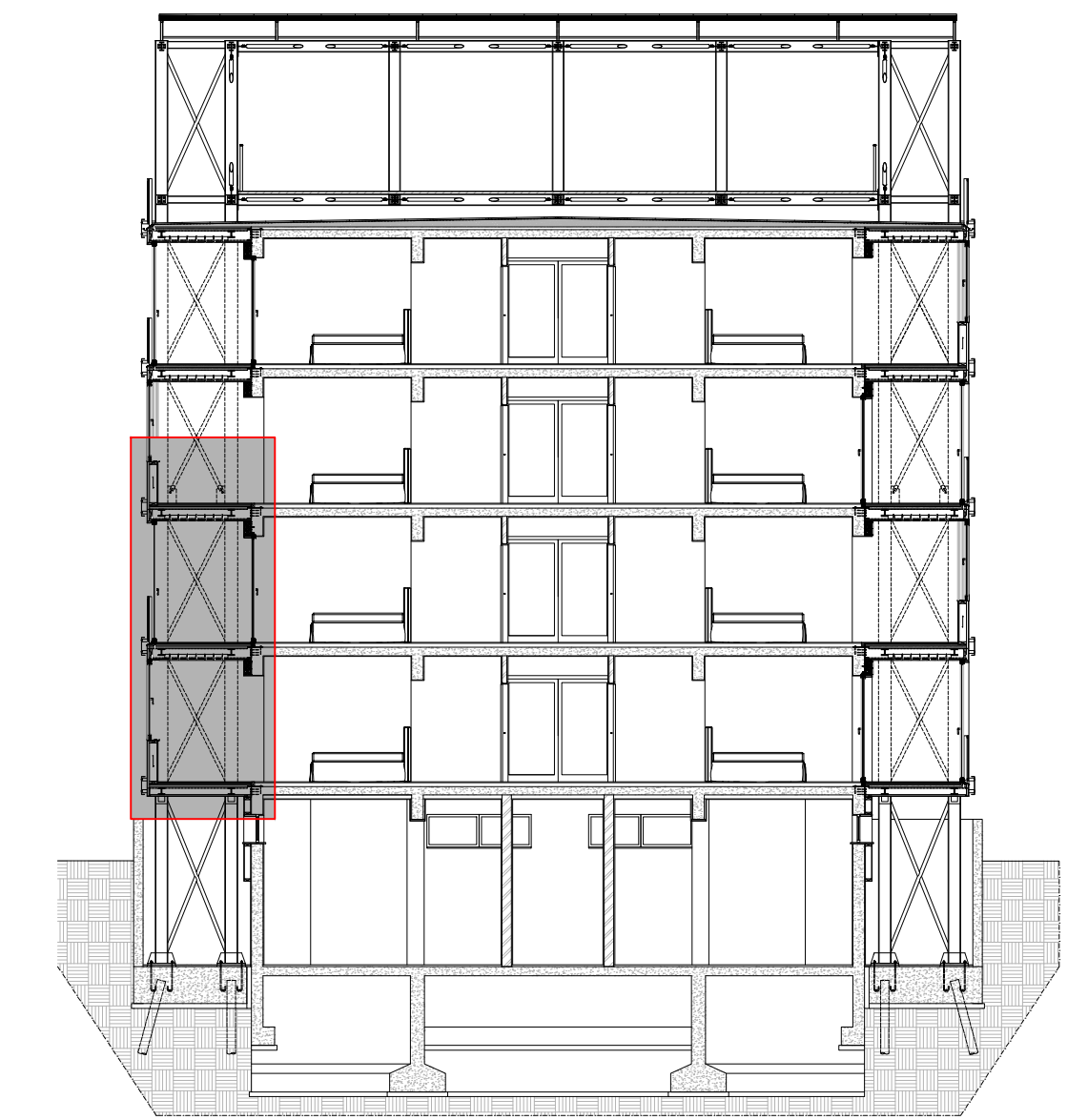

Acknowledgement

Proactive synergy of inteGrated Efficient Technologies on buildings Envelopes. The outputs of this research are part of the Pro-GET-onE project, which has received funding from the European Union's Horizon 2020 Innovation action under grand agreement No 723747



Annexes to the doctoral thesis entitled

On the use of the exoskeleton for seismic improvement and integrated efficient technologies in existing buildings

of the candidate

Lorenzo Badini

Alma Mater Studiorum - University of Bologna
 School of Engineering and Architecture
 Department of Architecture

Technical University of Munich
 Department of Civil, Geo and Environmental Engineering
 Chair of Timber Structures and Building Construction

Case Study:

Building FEPA at University Campus of Zografou, Athens (Greece)

Contents

Extra-room/Sun-space
 Vertical Cross Section
 Scale 1:10

Board N°

17



MAIN FAÇADE - Balcony solution



MAIN FAÇADE - Extra-room solution



MAIN FAÇADE - Sun-space solution



MAIN FAÇADE - Mixed solution

Positioning on planimetric view

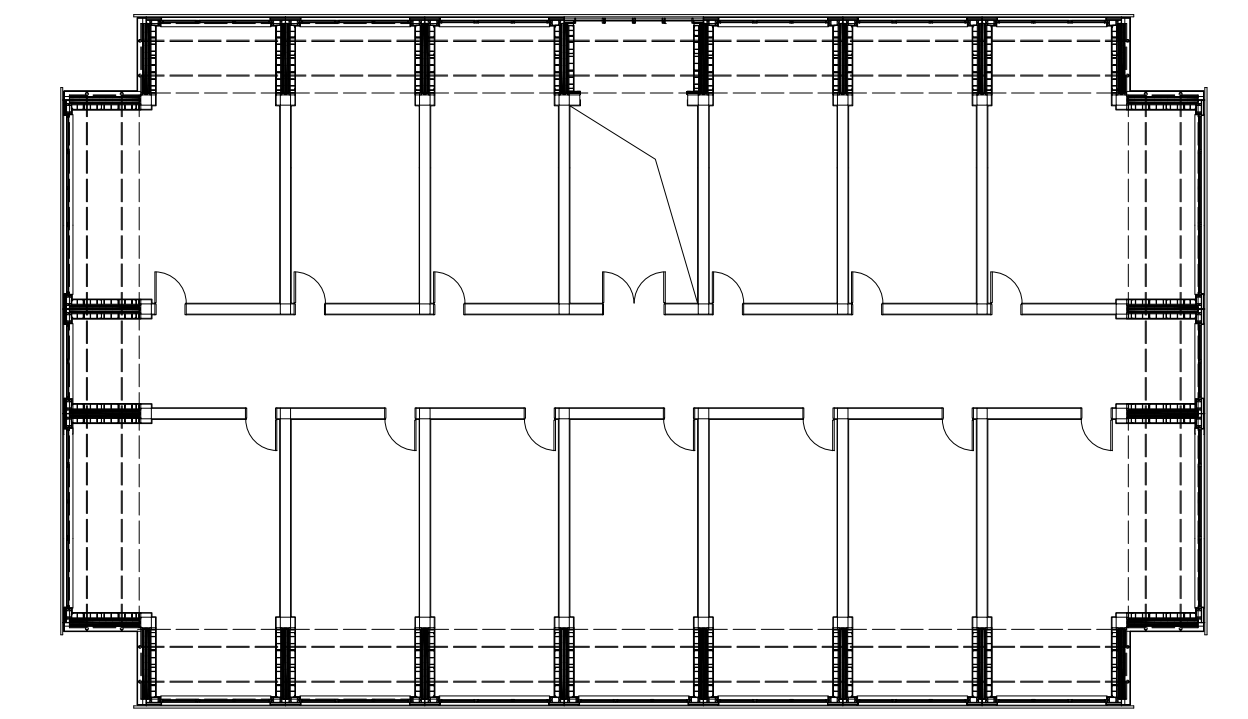

Main Façade

Acknowledgement

Proactive synergy of inteGrated Efficient Technologies on buildings Envelopes. The outputs of this research are part of the Pro-GET-onE project, which has received funding from the European Union's Horizon 2020 Innovation action under grand agreement No 723747



Annexes to the doctoral thesis entitled

On the use of the exoskeleton for seismic improvement and integrated efficient technologies in existing buildings

of the candidate

Lorenzo Badini

Alma Mater Studiorum - University of Bologna
School of Engineering and Architecture
Department of Architecture

Technical University of Munich
Department of Civil, Geo and Environmental Engineering
Chair of Timber Structures and Building Construction

Case Study:

Moment-resisting RC building, Brasov (Romania)

Contents

Main façade with different distribution of architectural units
Scale 1:100

Board N°

1

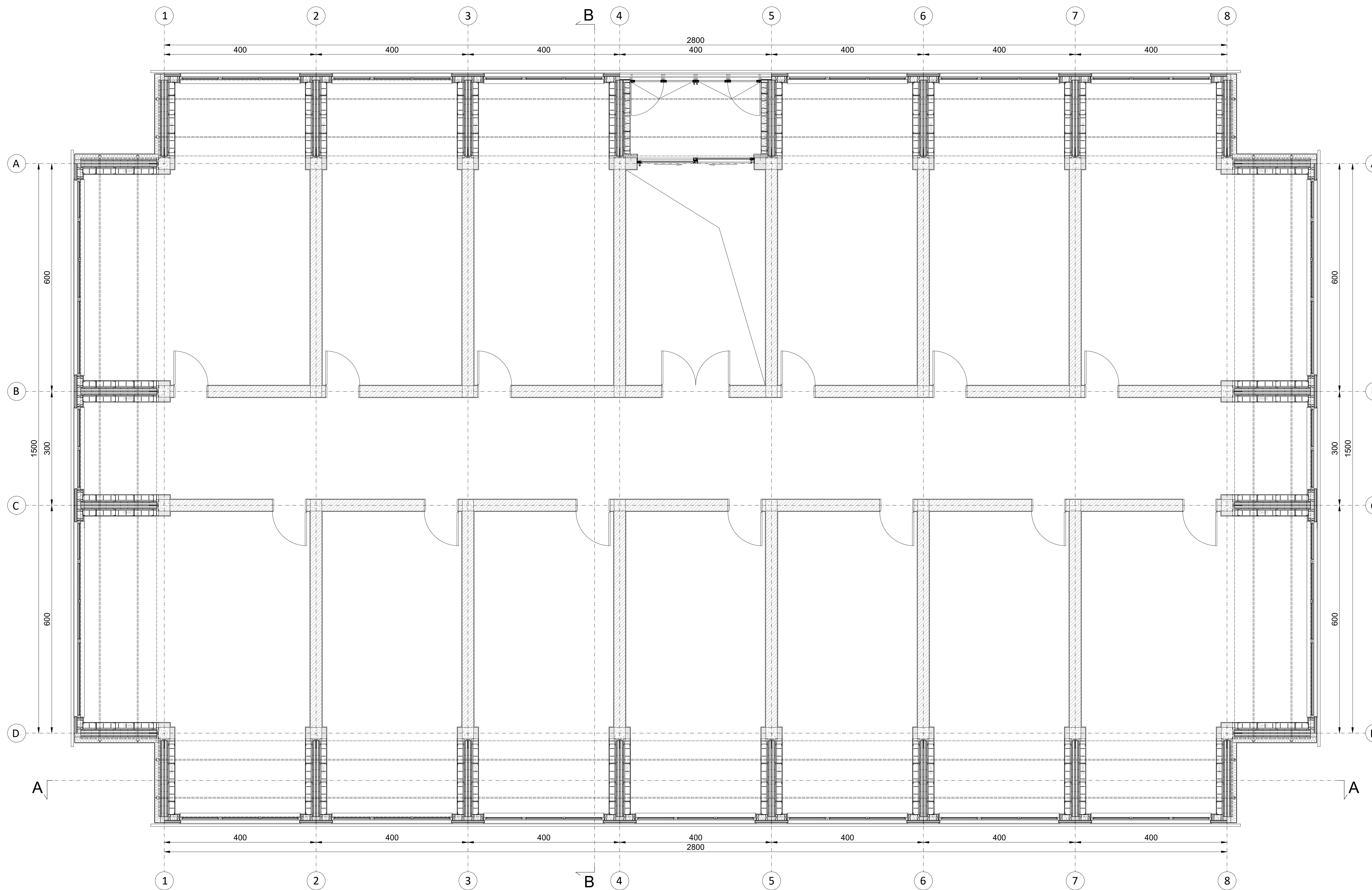

Positioning on façade and vertical cross-section



Acknowledgement

Proactive synergy of inteGrated Efficient Technologies on buildings Envelopes. The outputs of this research are part of the Pro-GET-onE project, which has received funding from the European Union's Horizon 2020 Innovation action under grand agreement No 723747



Annexes to the doctoral thesis entitled

On the use of the exoskeleton for seismic improvement and integrated efficient technologies in existing buildings

of the candidate

Lorenzo Badini

Alma Mater Studiorum - University of Bologna
School of Engineering and Architecture
Department of Architecture

Technical University of Munich
Department of Civil, Geo and Environmental Engineering
Chair of Timber Structures and Building Construction

Case Study:

Moment-resisting RC building, Brasov (Romania)

Contents

Extra-room solution
Type plan
Scale 1:50

Board N°

2

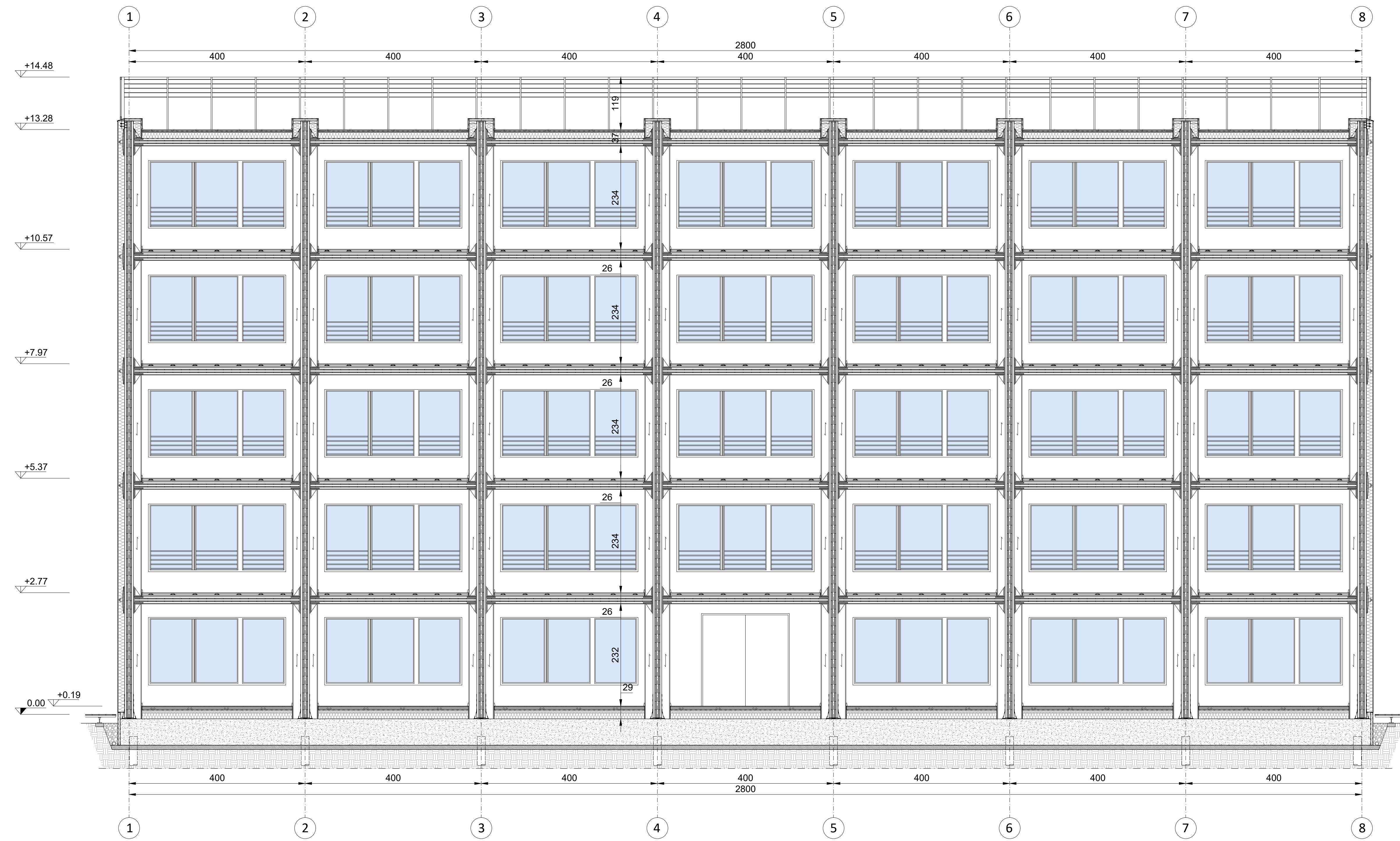

SECTION A-A - Extra-room solution

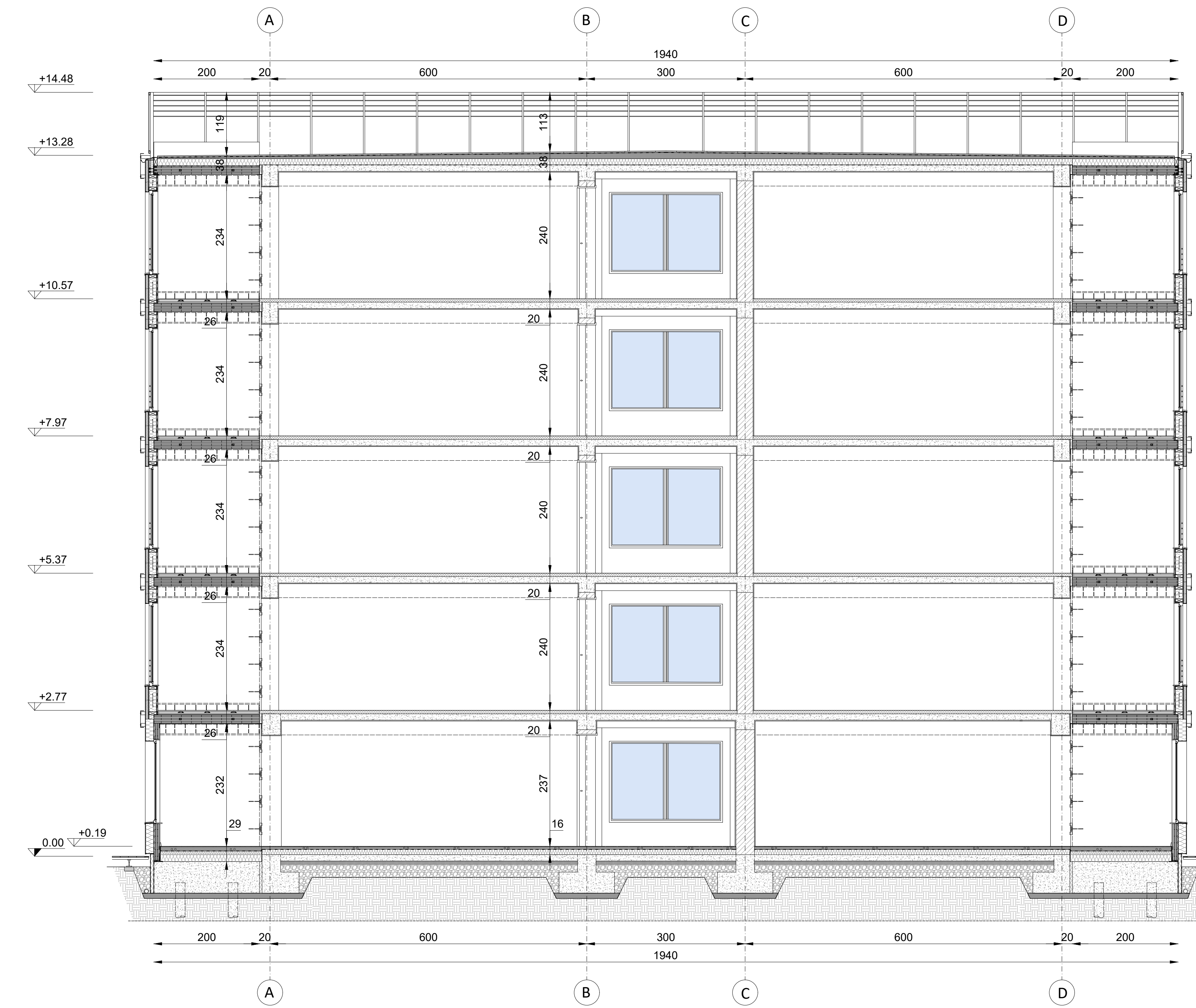

SECTION B-B - Extra-room solution

Positioning on planimetric view

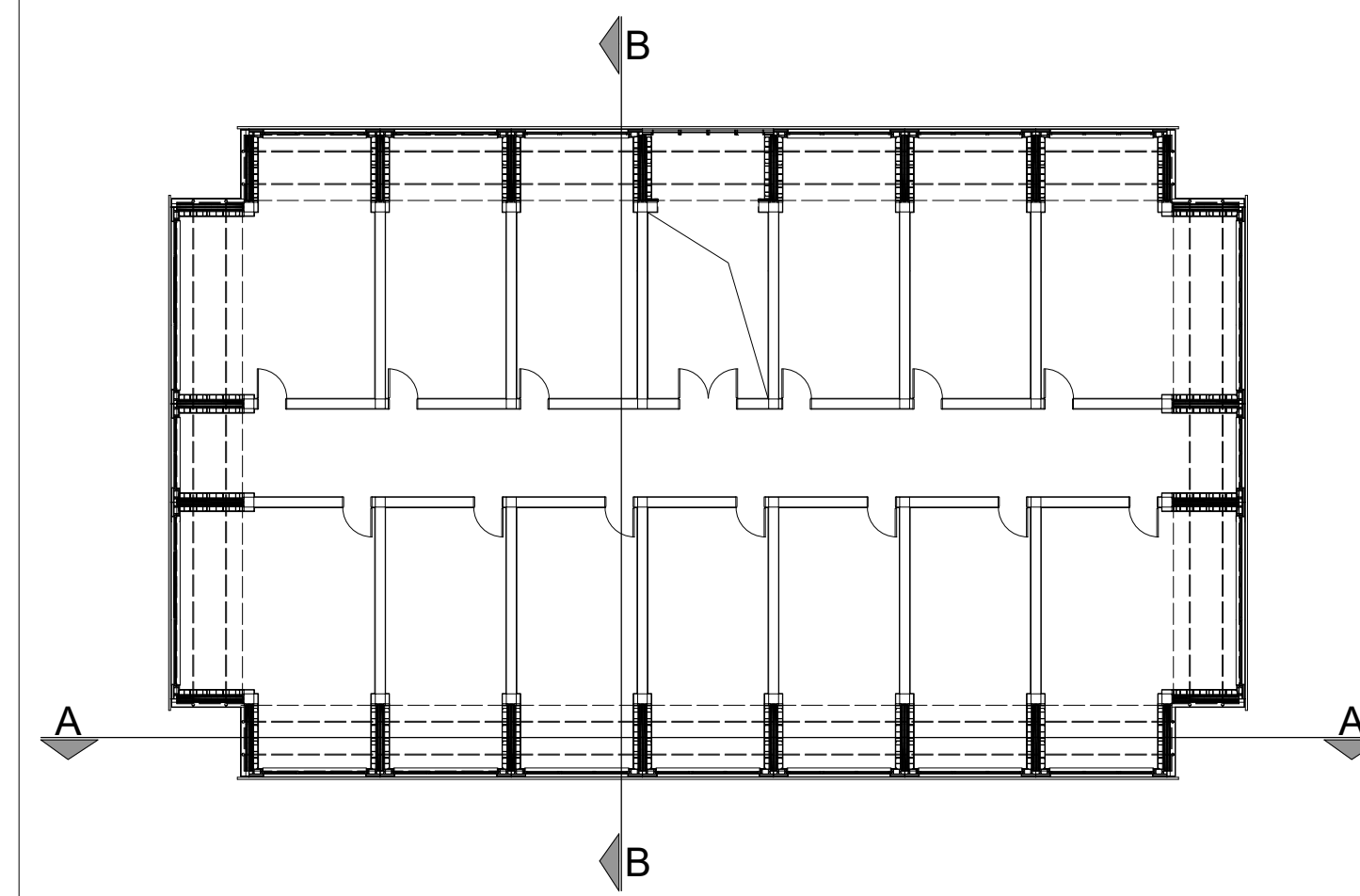

Acknowledgement

Proactive synergy of integrated Efficient Technologies on buildings Envelopes. The outputs of this research are part of the Pro-GET-one project, which has received funding from the European Union's Horizon 2020 Innovation action under grand agreement No 723747



Annexes to the doctoral thesis entitled

On the use of the exoskeleton for seismic improvement and integrated efficient technologies in existing buildings

of the candidate

Lorenzo Badini

Alma Mater Studiorum - University of Bologna
School of Engineering and Architecture
Department of Architecture

Technical University of Munich
Department of Civil, Geo and Environmental Engineering
Chair of Timber Structures and Building Construction

Case Study:

Moment-resisting RC building, Brasov (Romania)

Contents

Extra-room solution
Vertical cross-section A-A
Vertical cross-section B-B
Scale 1:50

Board N°

3

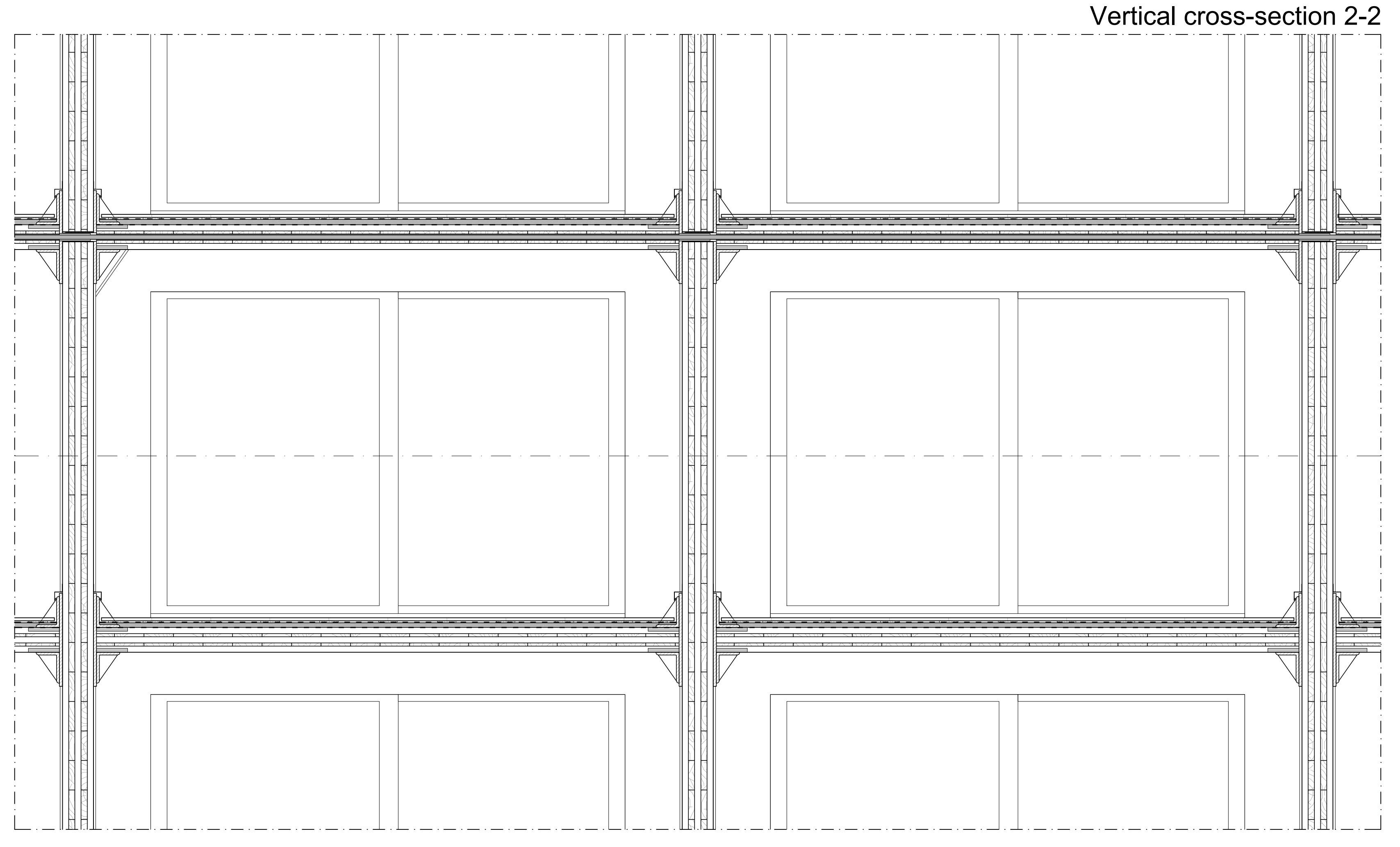
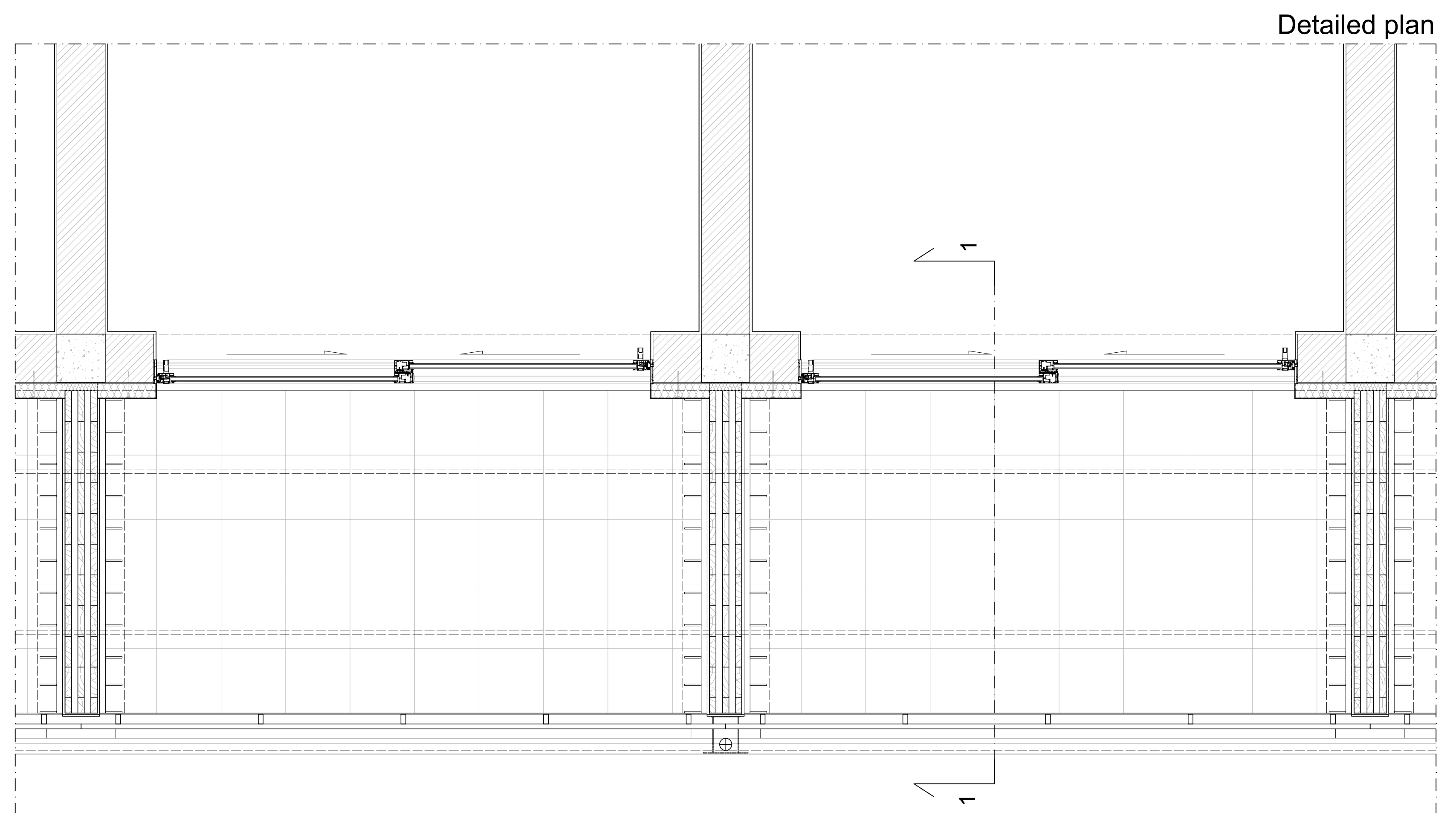
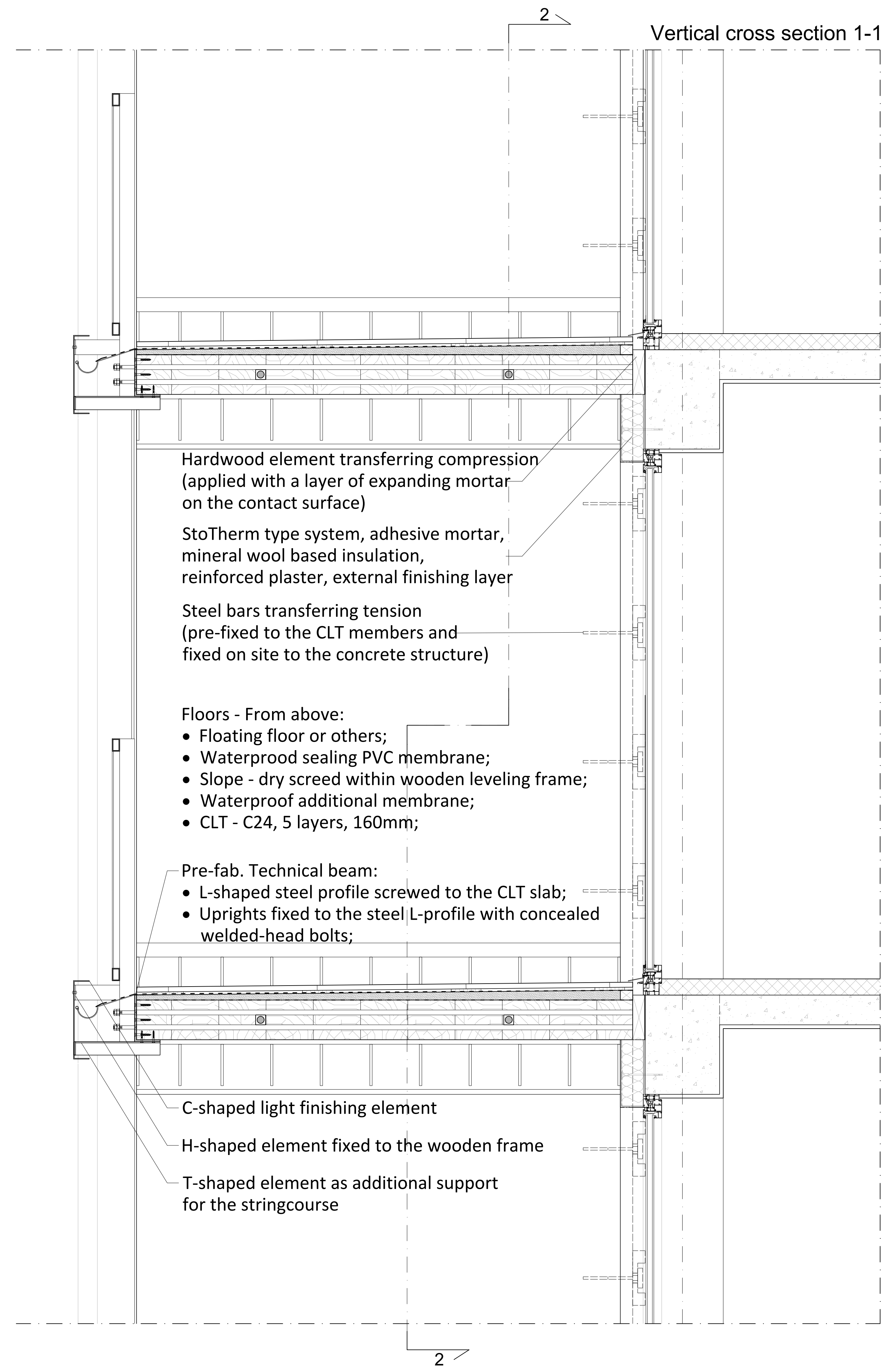

Positioning on horizontal and vertical cross-sections

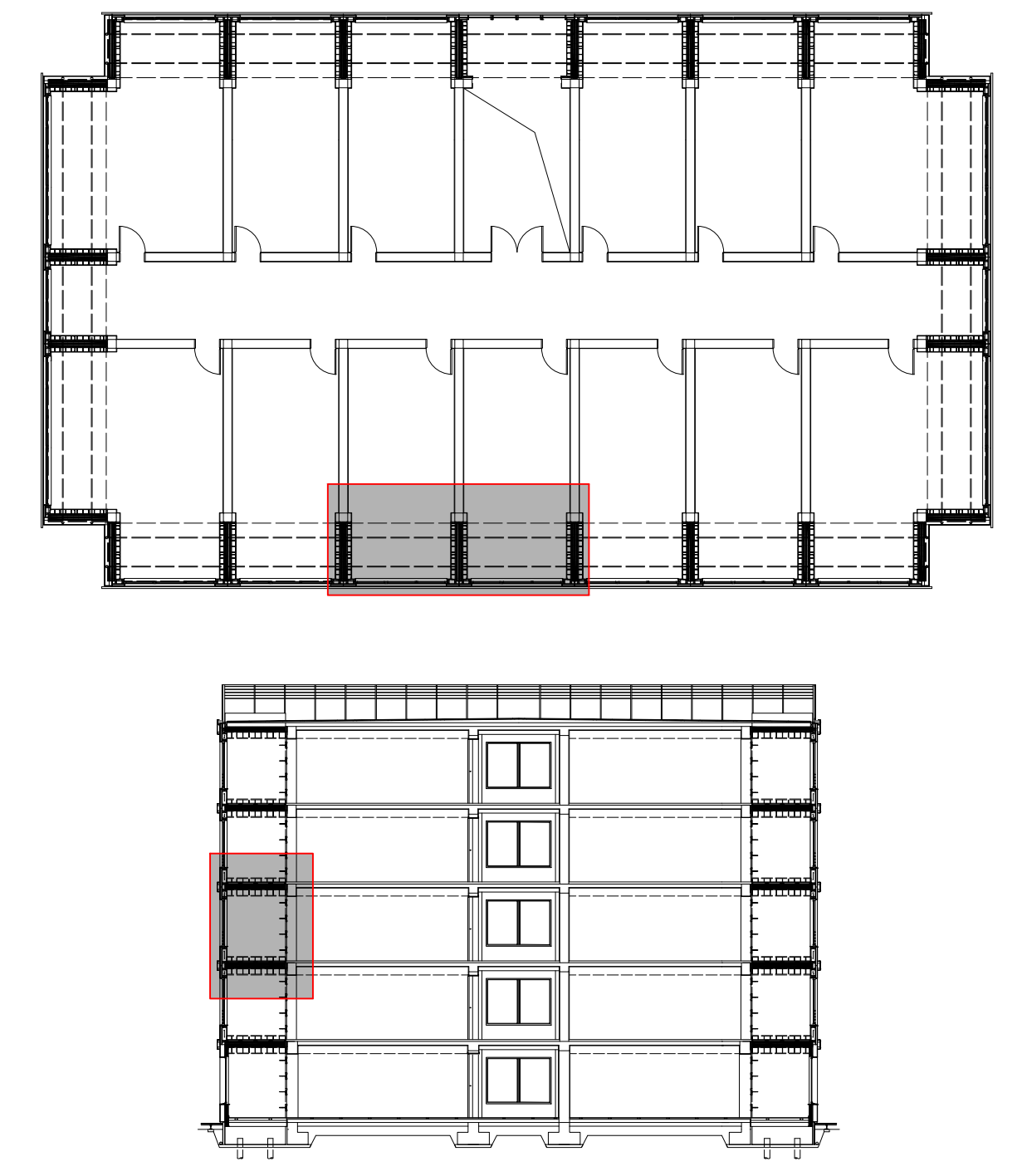

Acknowledgement

Proactive synergy of inteGrated Efficient Technologies on buildings Envelopes. The outputs of this research are part of the Pro-GET-onE project, which has received funding from the European Union's Horizon 2020 Innovation action under grand agreement No 723747



Annexes to the doctoral thesis entitled

On the use of the exoskeleton for seismic improvement and integrated efficient technologies in existing buildings

of the candidate

Lorenzo Badini

Alma Mater Studiorum - University of Bologna
School of Engineering and Architecture
Department of Architecture

Technical University of Munich
Department of Civil, Geo and Environmental Engineering
Chair of Timber Structures and Building Construction

Case Study:

Moment-resisting RC building, Brasov (Romania)

Contents

- Detail of the balcony solution
- Horizontal cross section
- Vertical cross section 2-2
- Scale 1:20
- Vertical cross section 1-1
- Scale 1:10

Board N°

4

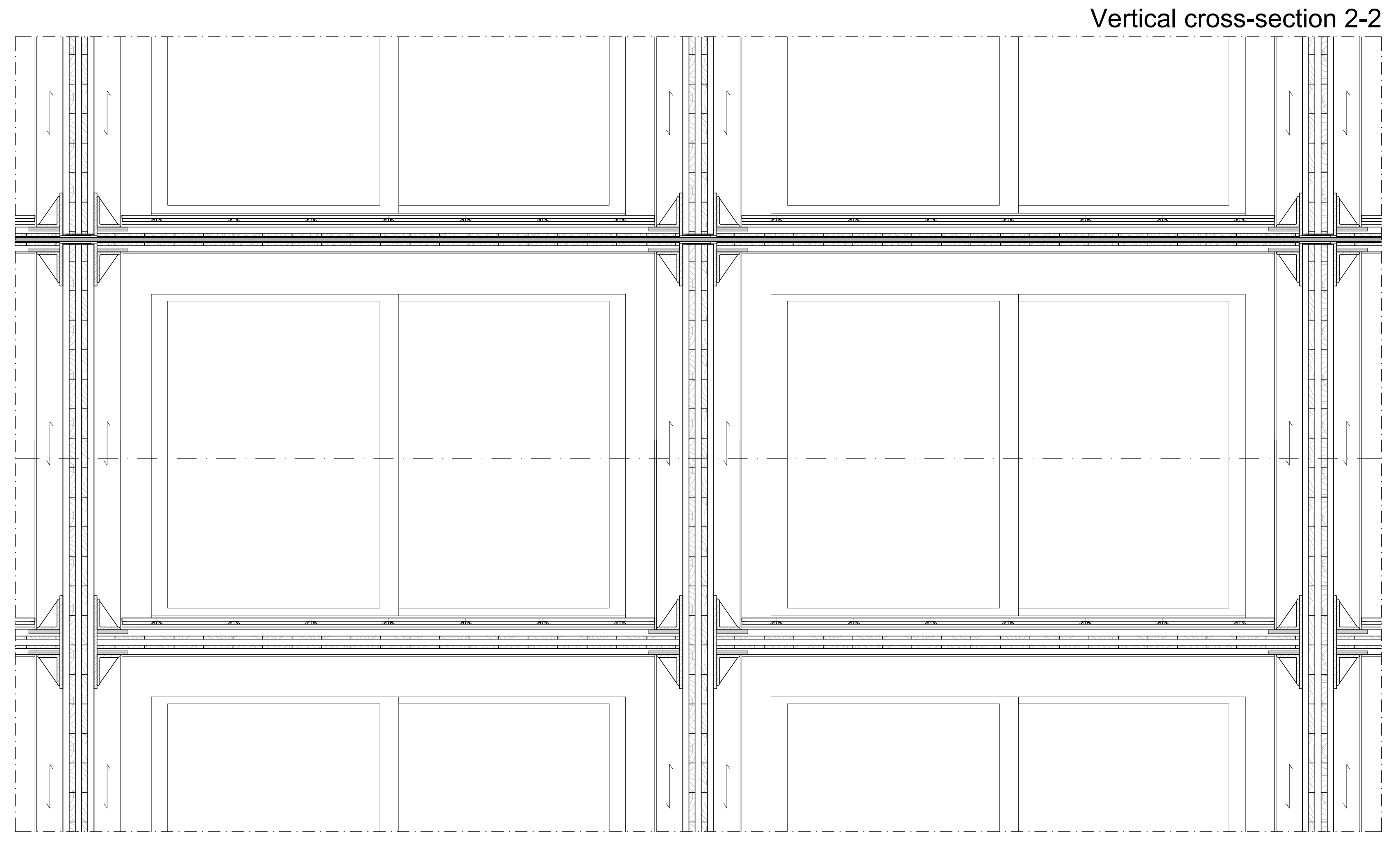
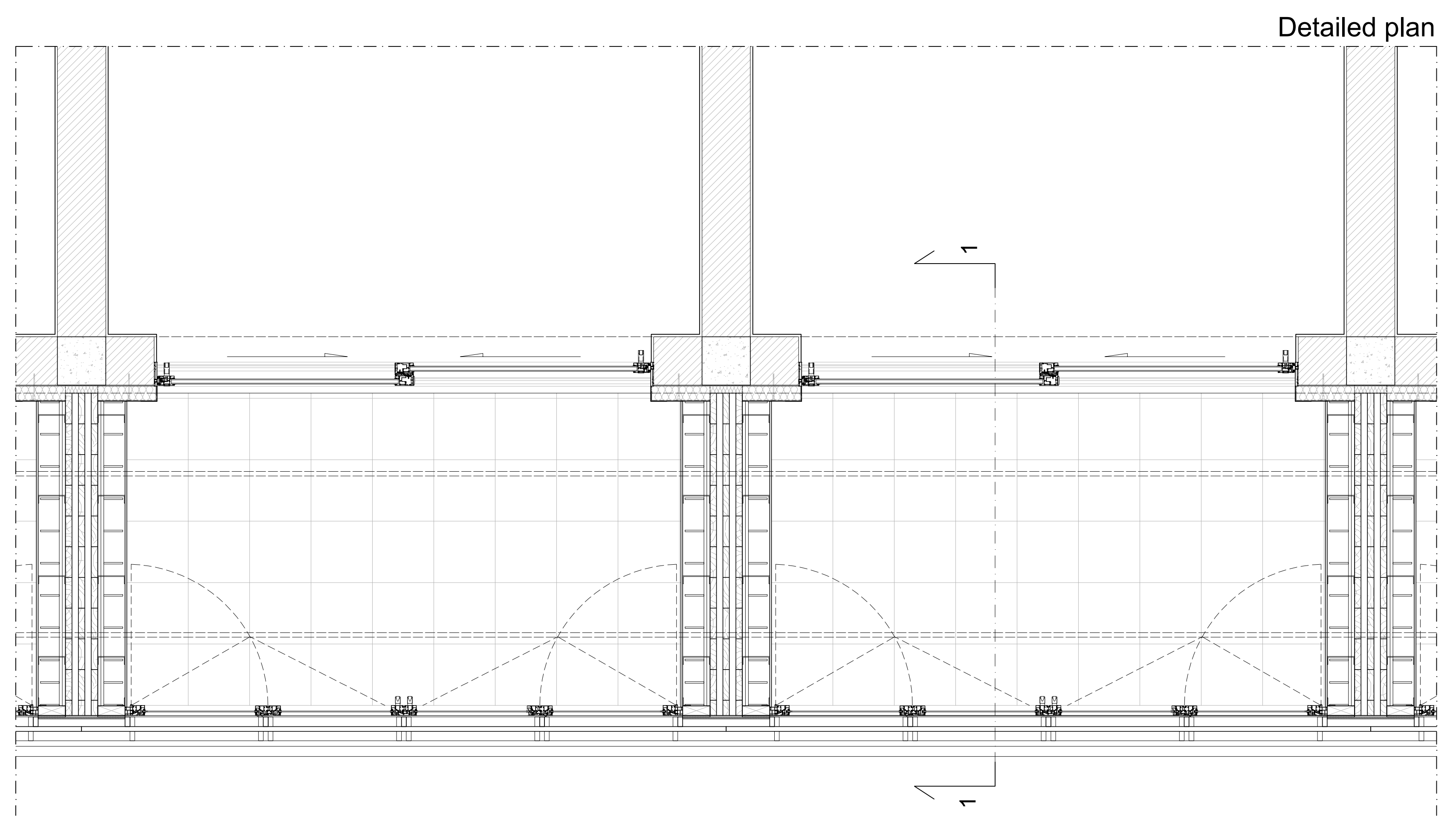
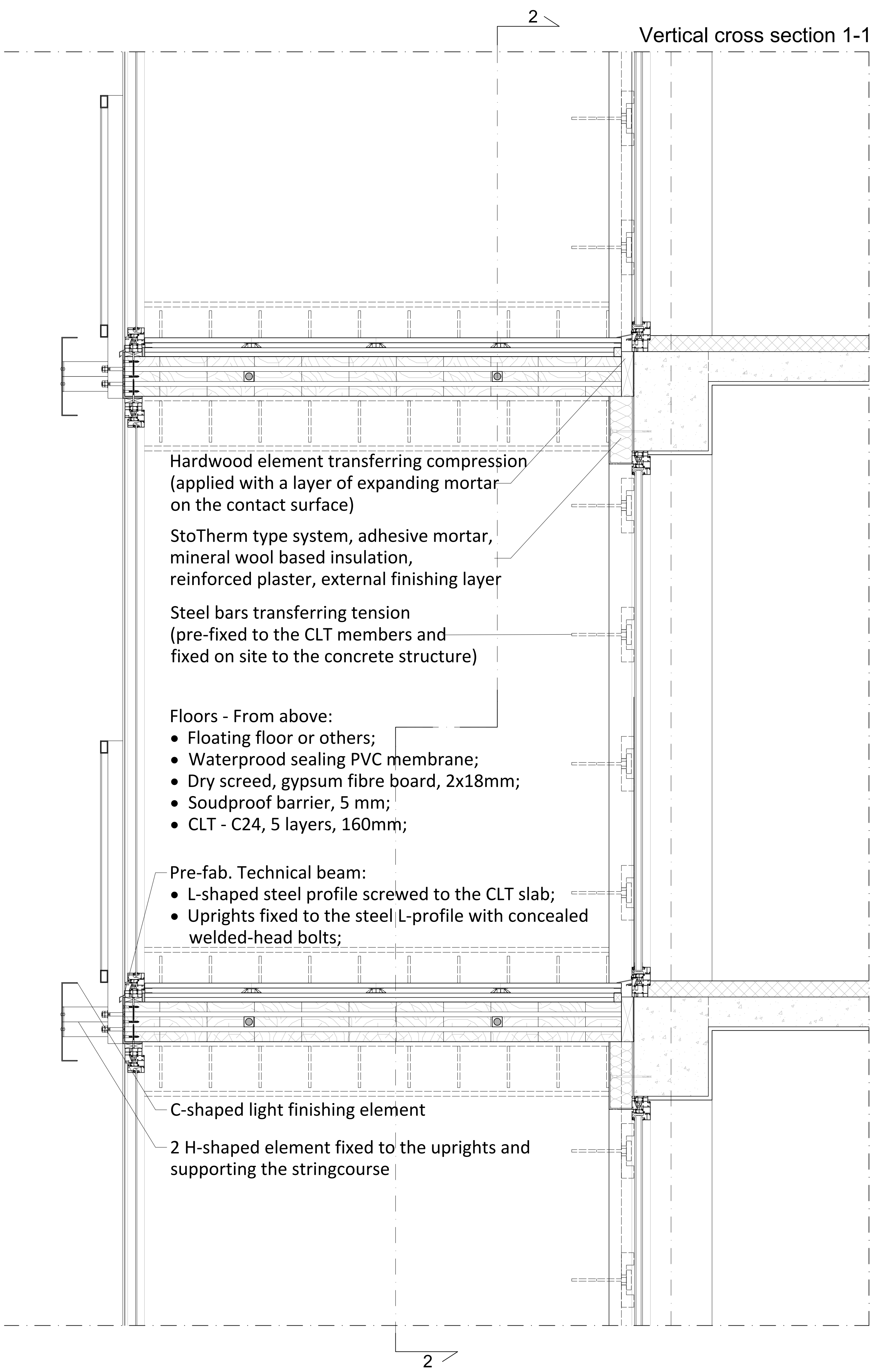

Positioning on horizontal and vertical cross-sections

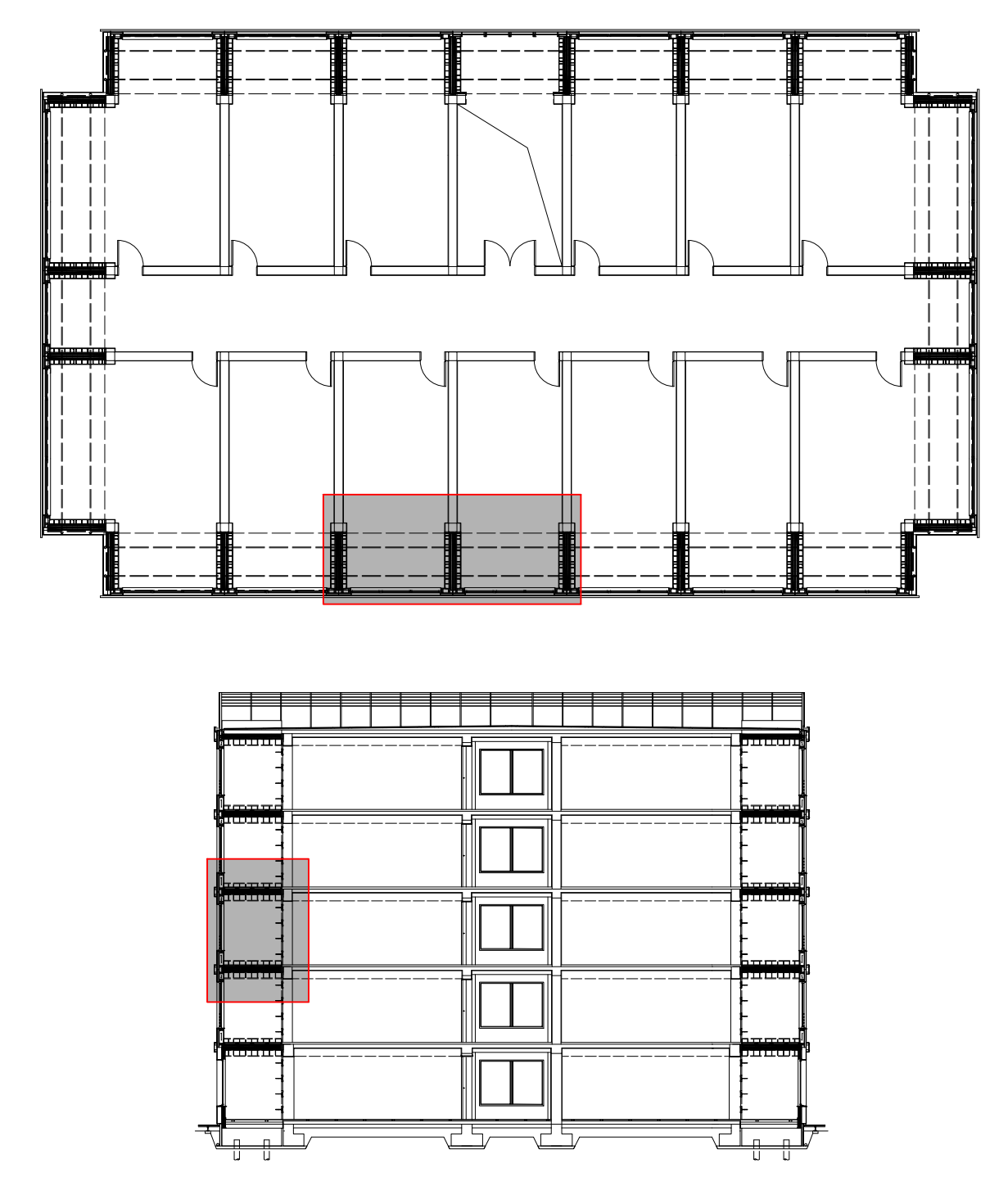

Acknowledgement

Proactive synergy of inteGrated Efficient Technologies on buildings Envelopes. The outputs of this research are part of the Pro-GET-onE project, which has received funding from the European Union's Horizon 2020 Innovation action under grand agreement No 723747



Annexes to the doctoral thesis entitled

On the use of the exoskeleton for seismic improvement and integrated efficient technologies in existing buildings

of the candidate

Lorenzo Badini

Alma Mater Studiorum - University of Bologna
School of Engineering and Architecture
Department of Architecture

Technical University of Munich
Department of Civil, Geo and Environmental Engineering
Chair of Timber Structures and Building Construction

Case Study:

Moment-resisting RC building, Brasov (Romania)

Contents

- Detail of the sun-space solution
- Horizontal cross section
- Vertical cross section 2-2
- Scale 1:20
- Vertical cross section 1-1
- Scale 1:10

Board N°

5

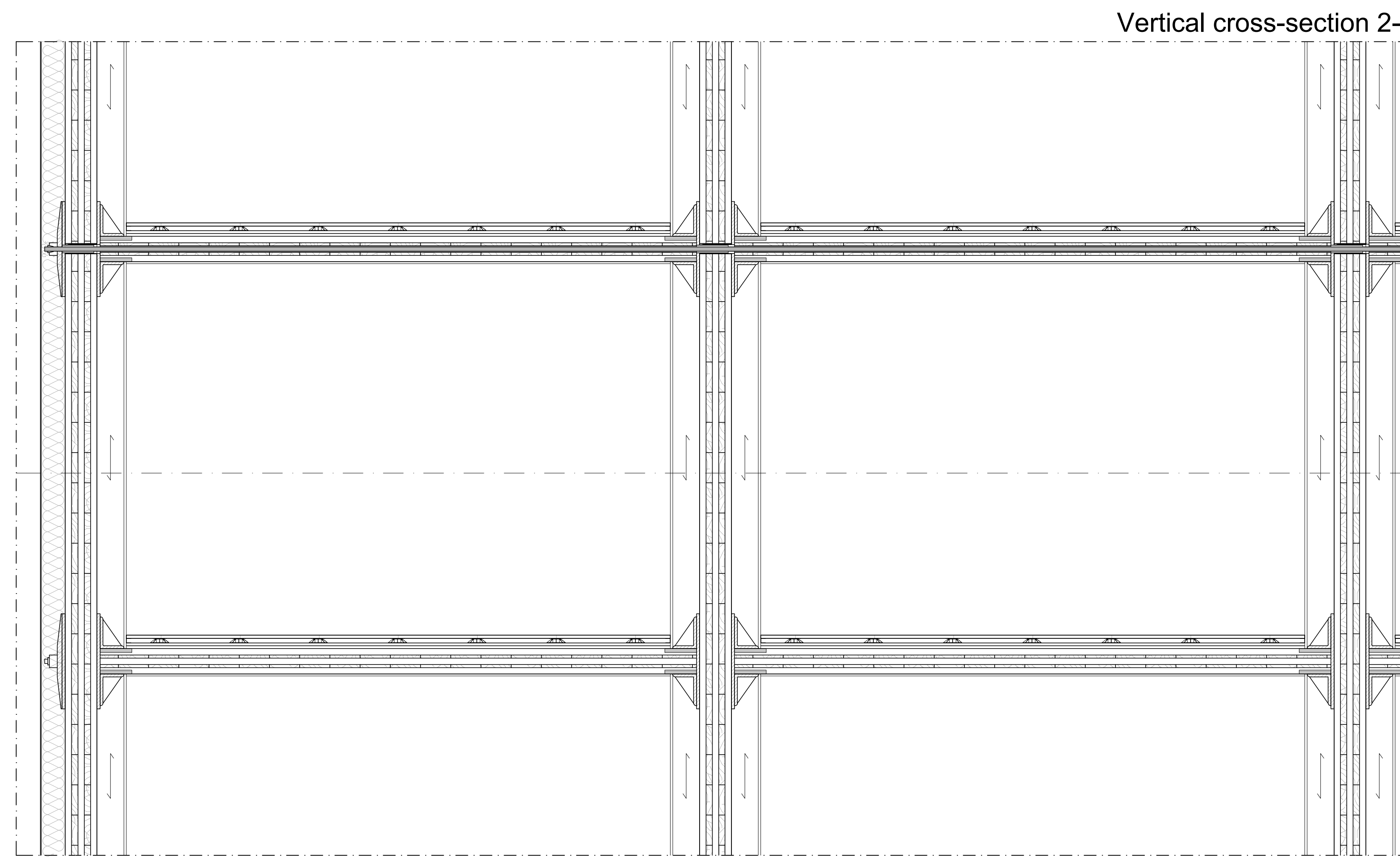
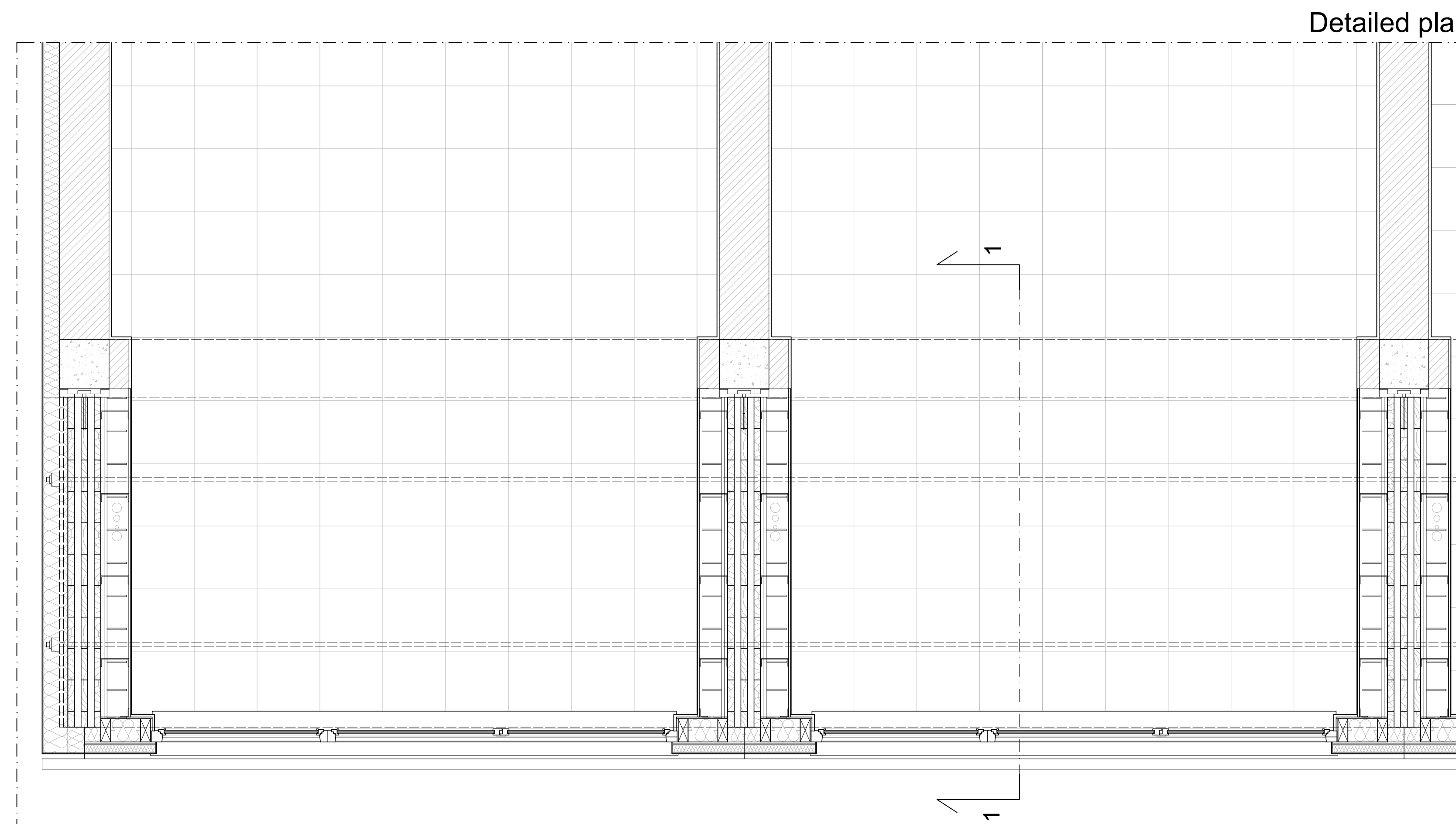
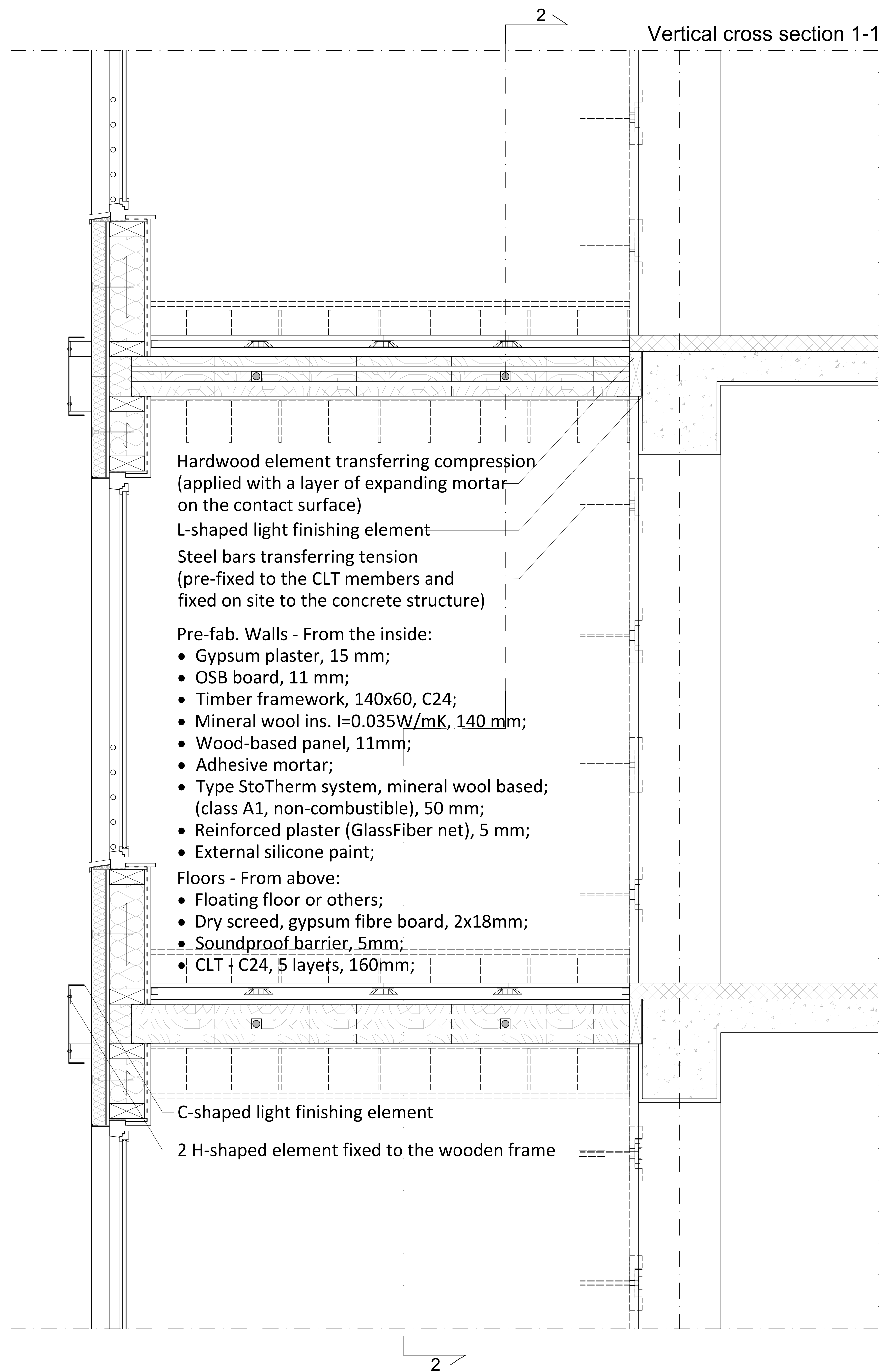

Detailed plan

Vertical cross-section 2-2

Positioning on horizontal and vertical cross-sections

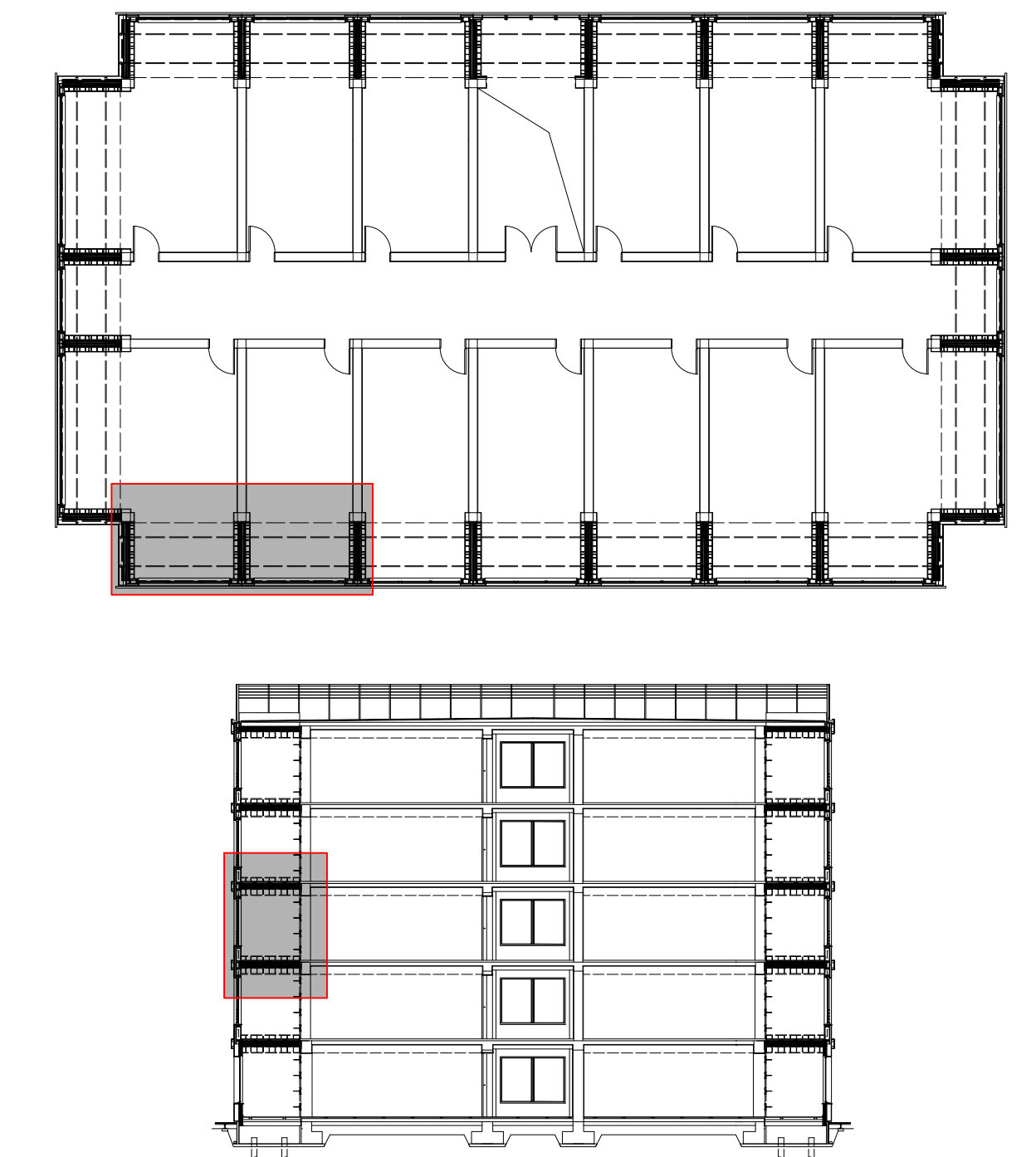

Acknowledgement

Proactive synergy of inteGrated Efficient Technologies on buildings Envelopes. The outputs of this research are part of the Pro-GET-onE project, which has received funding from the European Union's Horizon 2020 Innovation action under grand agreement No 723747



Annexes to the doctoral thesis entitled

On the use of the exoskeleton for seismic improvement and integrated efficient technologies in existing buildings

of the candidate

Lorenzo Badini

Alma Mater Studiorum - University of Bologna
School of Engineering and Architecture
Department of Architecture

Technical University of Munich
Department of Civil, Geo and Environmental Engineering
Chair of Timber Structures and Building Construction

Case Study:

Moment-resisting RC building, Brasov (Romania)

Contents

Detail of the extra-room solution
Horizontal cross section
Vertical cross section 2-2
Scale 1:20
Vertical cross section 1-1
Scale 1:10

Board N°

6

Balcony

Sun-space

Extra-Room

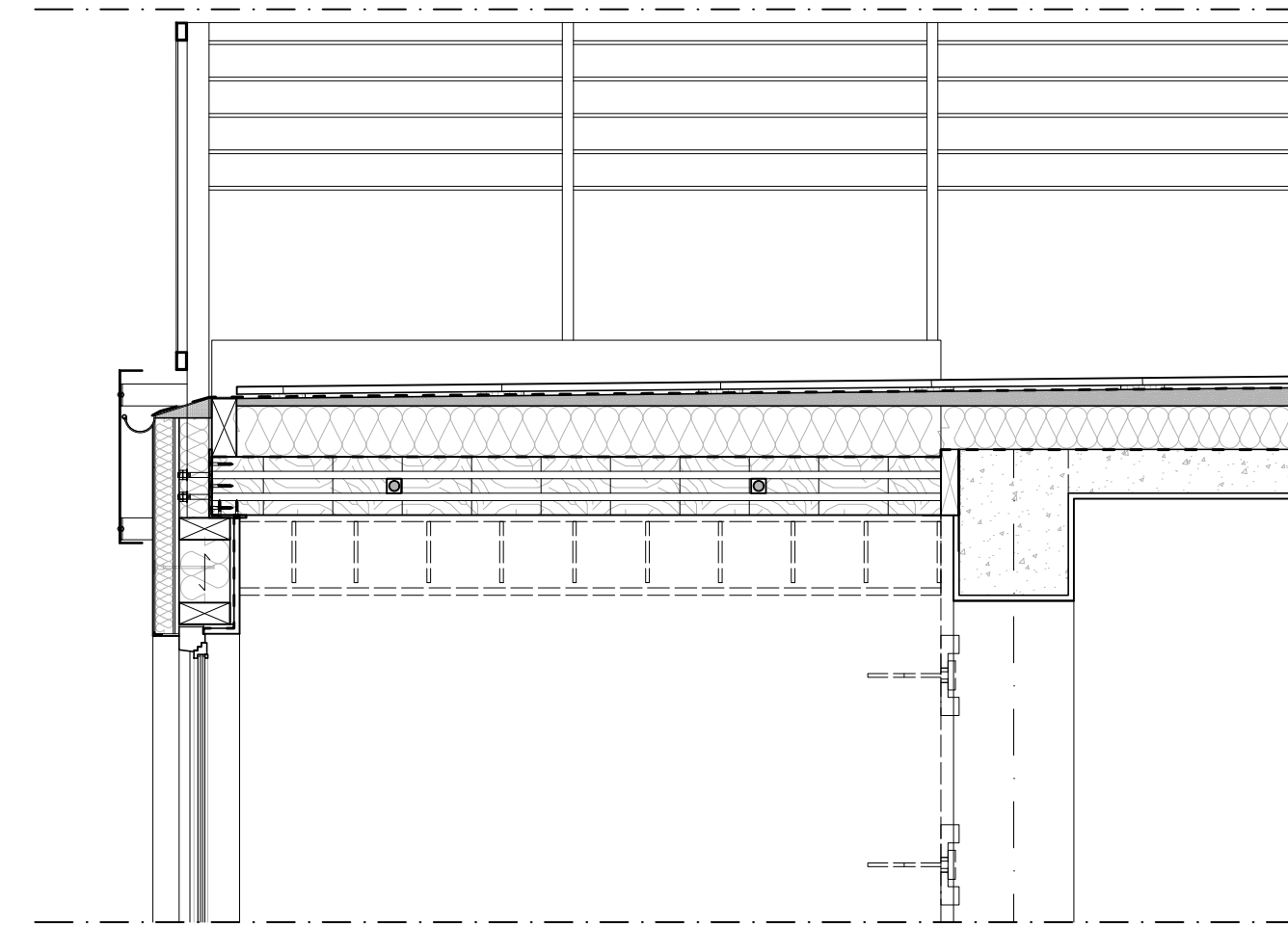
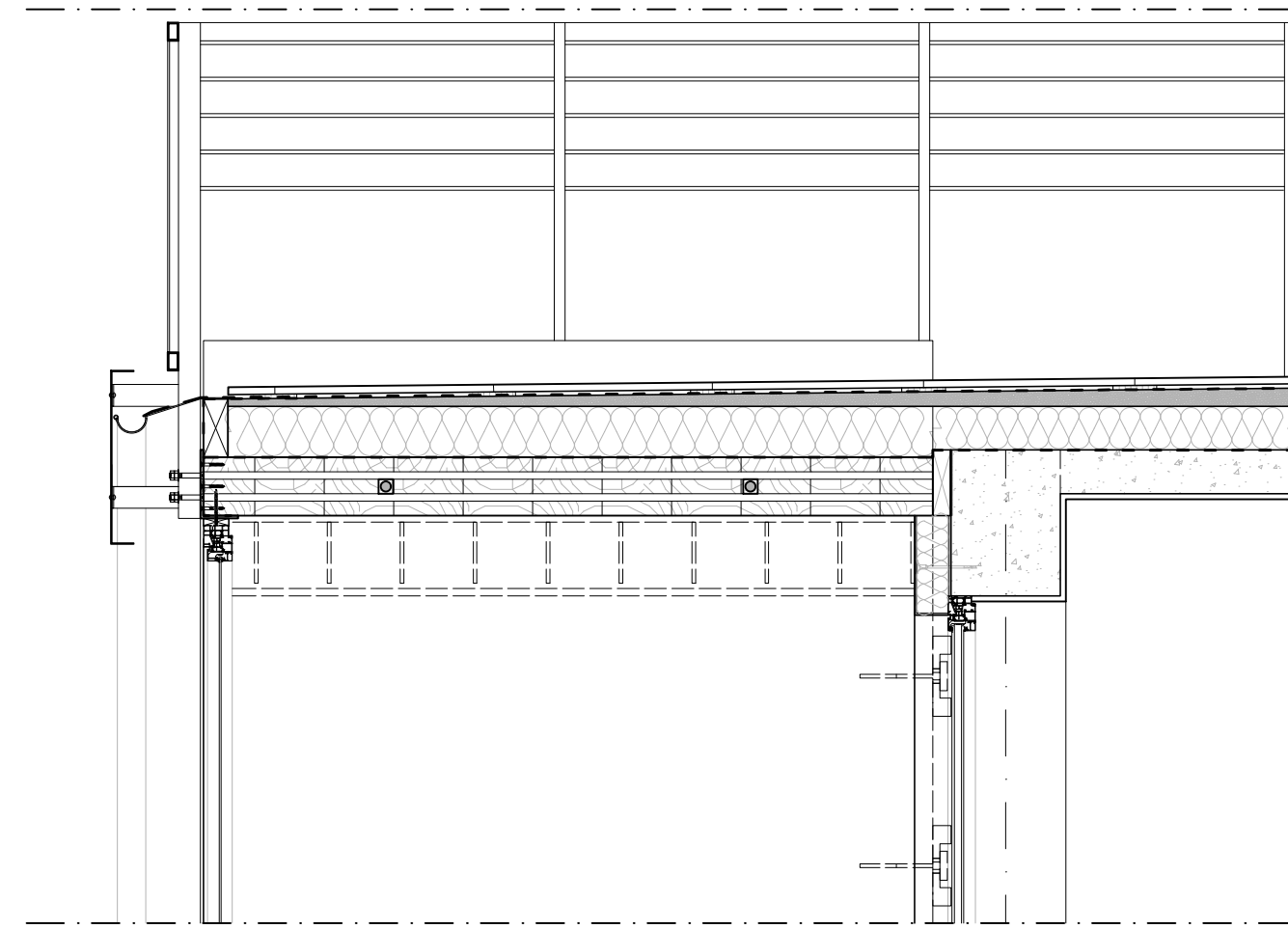
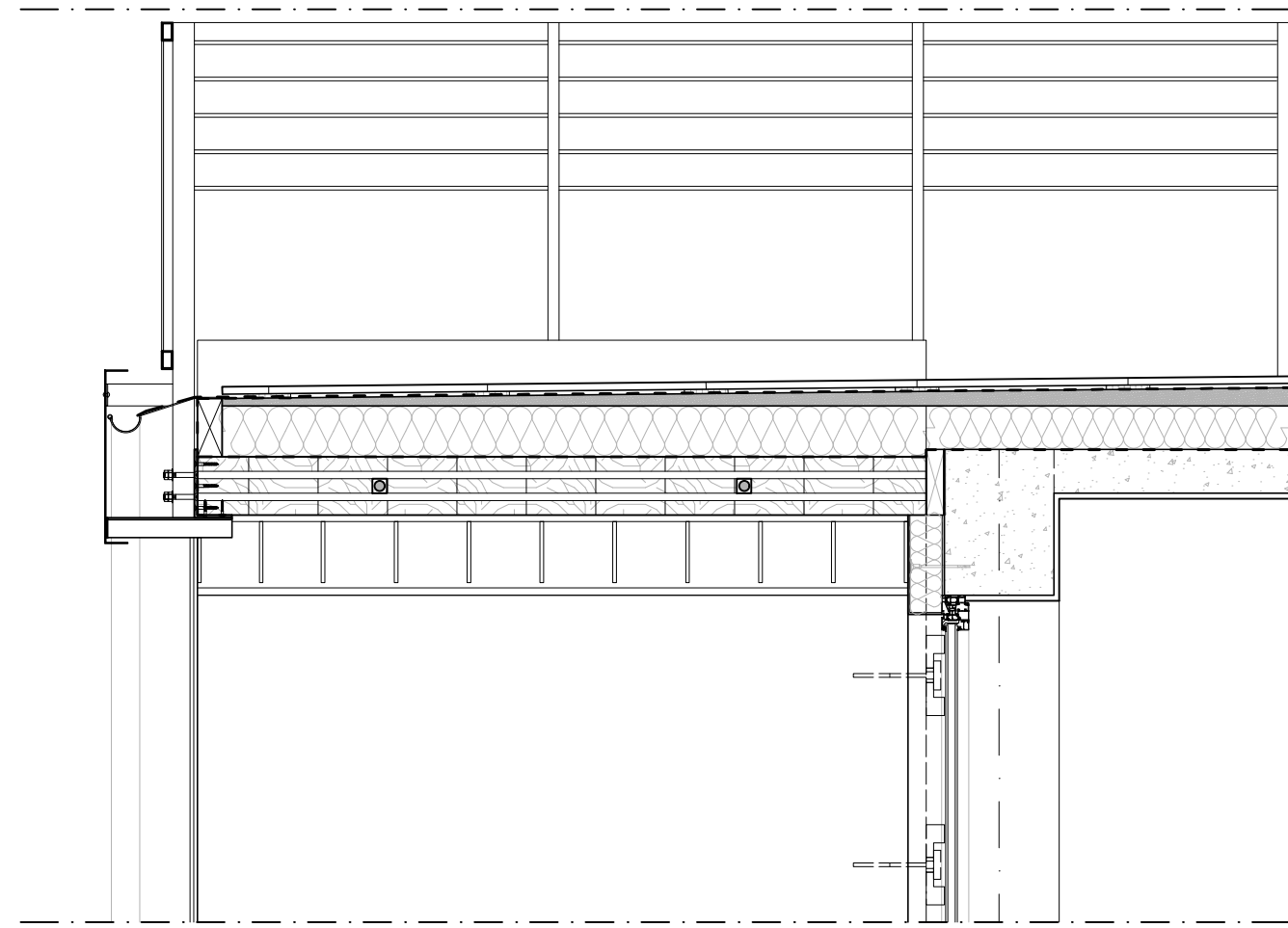

Balcony

Sun-space

Extra-Room

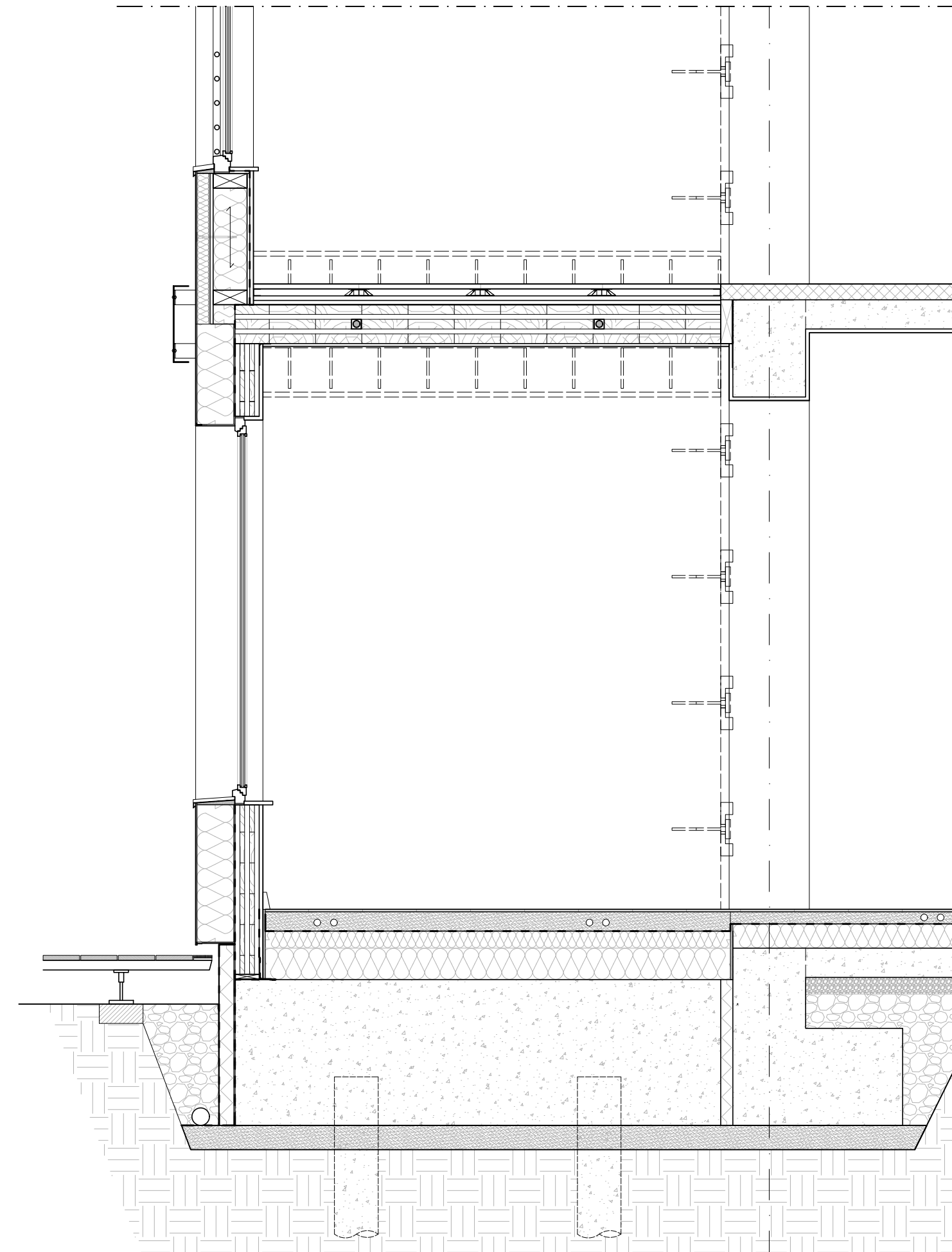
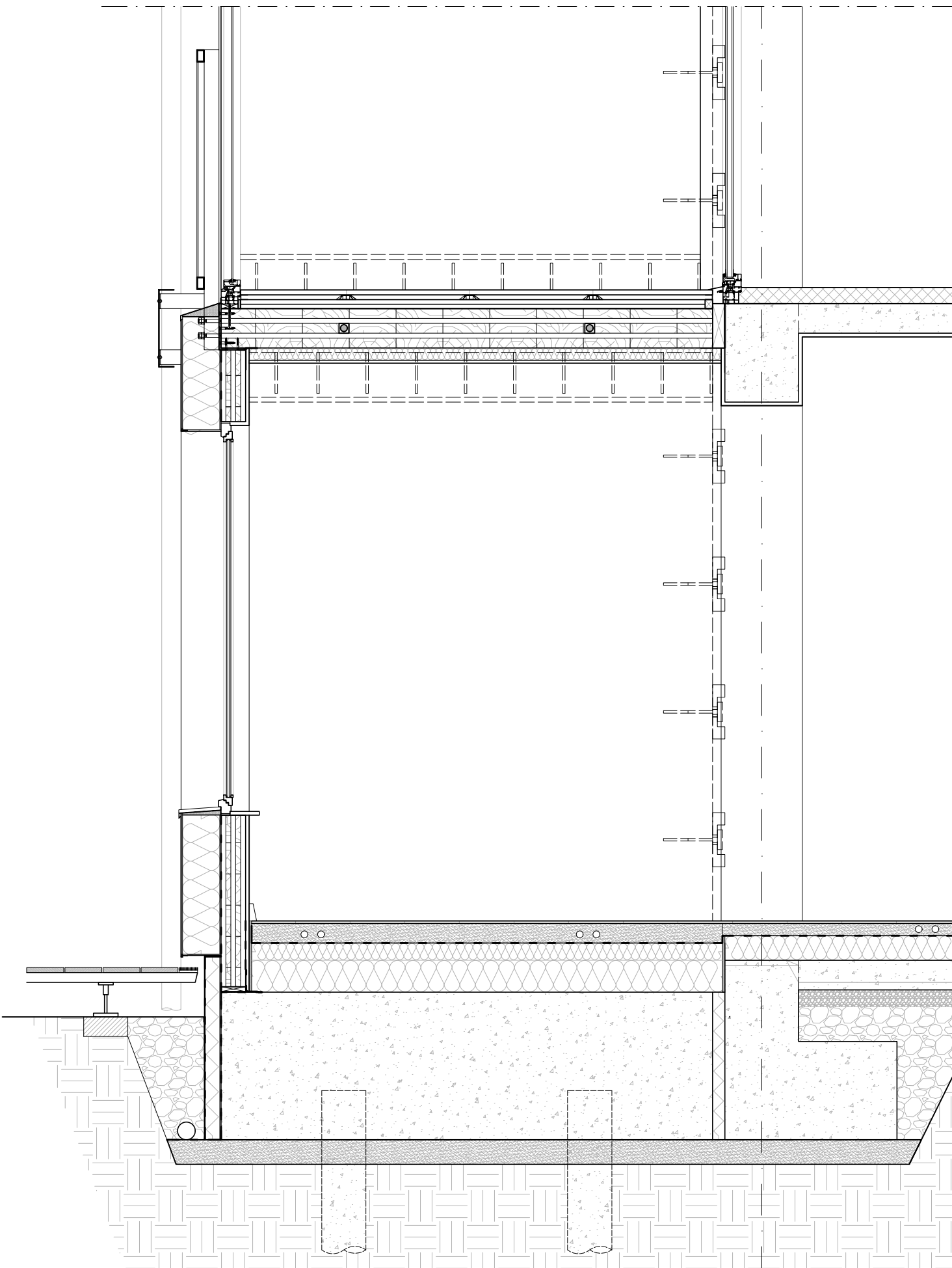
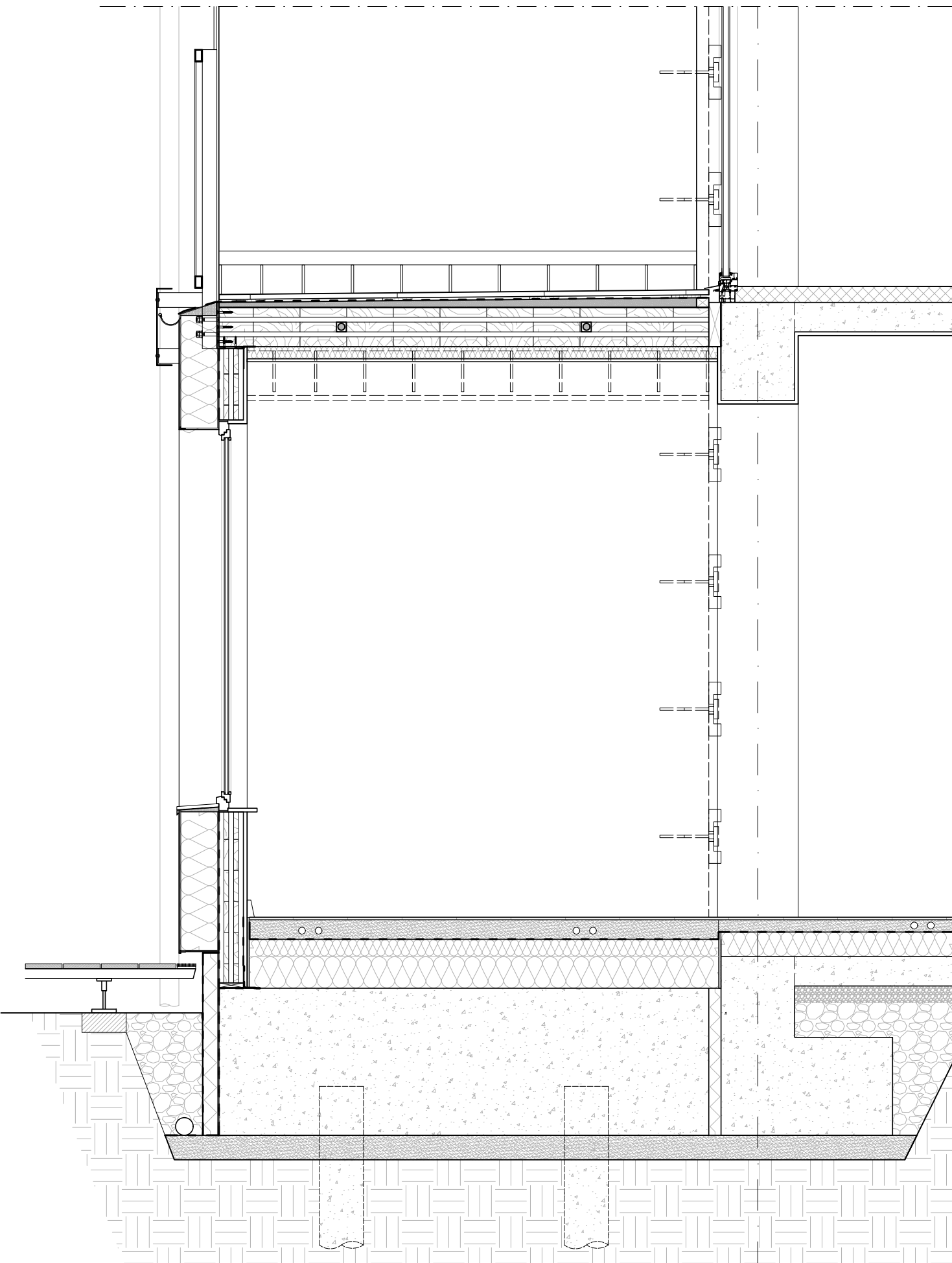

Positioning on horizontal and vertical cross-sections

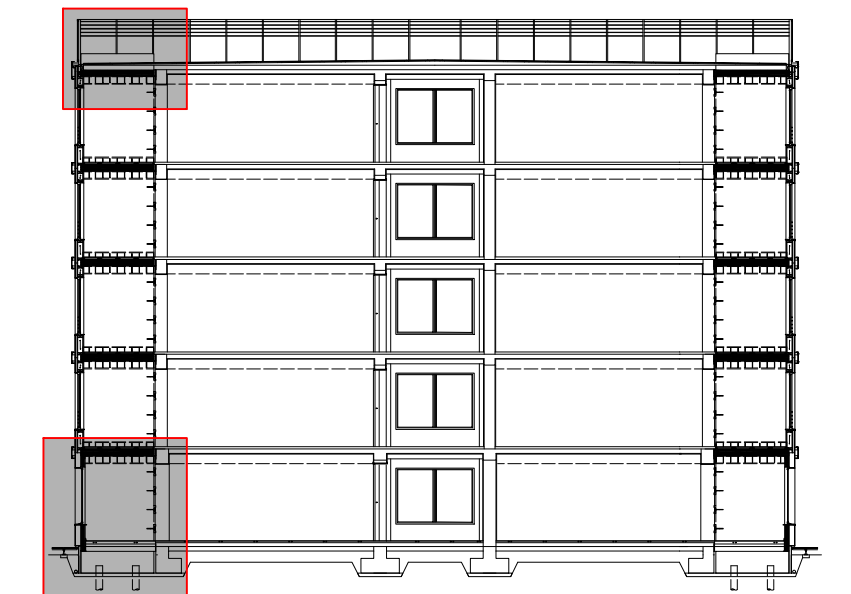
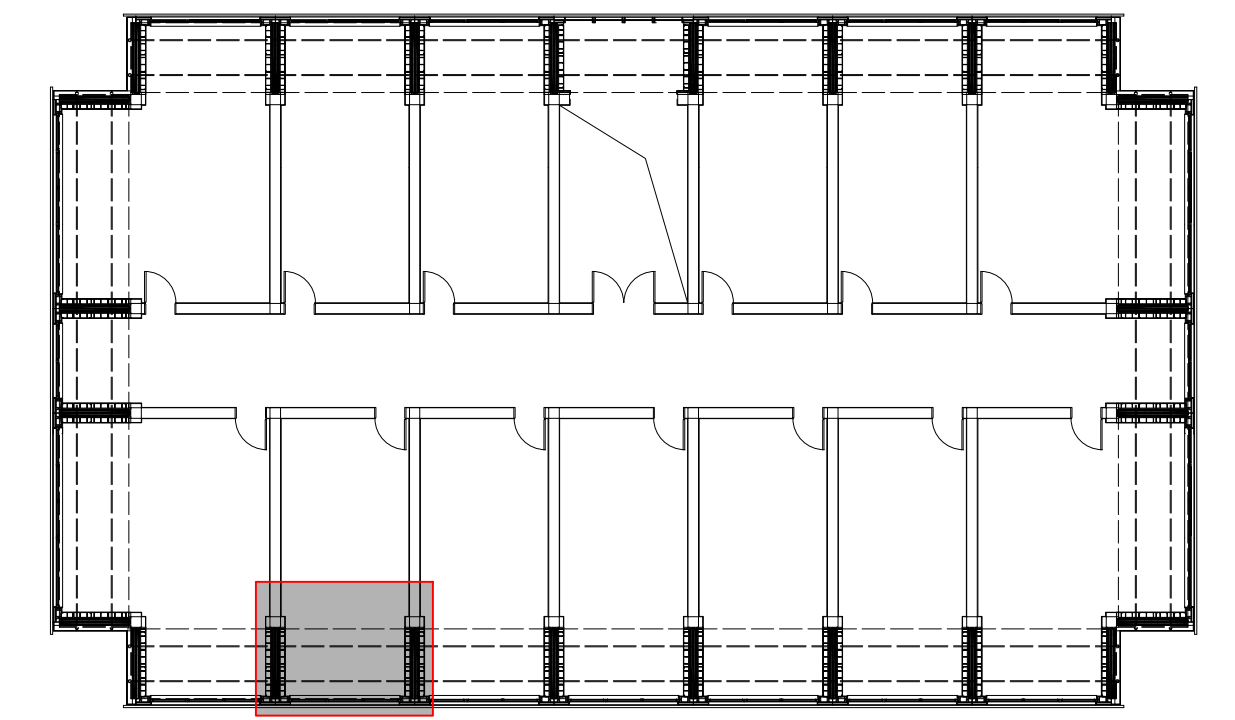

Acknowledgement

Proactive synergy of inteGrated Efficient Technologies on buildings Envelopes. The outputs of this research are part of the Pro-GET-onE project, which has received funding from the European Union's Horizon 2020 Innovation action under grand agreement No 723747



Annexes to the doctoral thesis entitled

On the use of the exoskeleton for seismic improvement and integrated efficient technologies in existing buildings

of the candidate

Lorenzo Badini

Alma Mater Studiorum - University of Bologna
School of Engineering and Architecture
Department of Architecture

Technical University of Munich
Department of Civil, Geo and Environmental Engineering
Chair of Timber Structures and Building Construction

Case Study:

Moment-resisting RC building, Brasov (Romania)

Contents

Details of roof and foundation
All solutions
Vertical cross section
Scale 1:20

Board N°

7